



GENERAL SURGERY

ALLGEMEINE CHIRURGIE

CHIRURGIE GÉNÉRALE

CIRUGÍA GENERAL

CHIRURGIA GENERALE



ARAIN & SON'S

Arain & Son's Pvt. Ltd,



Arain & Son's Pvt. Ltd, holds the privilege of being the manufacturing pioneers of the finest quality of surgical, dental and accessories in Sialkot, Pakistan. We have a large customer base which comprises of private hospitals and clinics internationally, namely UK, USA and Germany among the many.

TABLE OF CONTENTS

		Page #
00 VI	Company Profile Technical Information Firmenprofil Technische Informationen Profil de l'entreprise Information technique Perfil de la empresa Información técnica Profilo Compagnia Informazioni tecniche	Page VI to XVIII
01 2	Diagnosis Anesthesia Diagnose Anästhesie Diagnostic Anesthésie Diagnóstico Anestesia Diagnosi Anestesia	Page 2 to 24
02 25	Scalpel Blades and Handles Skalpellklingen und Skalpellgriffe Lames et manches de bistouris Hojas y mangos de bisturí Lame e manici per bisturi	Page 25 to 34
03 35	Scissors Scheren Ciseaux Tijeras Forbici	Page 35 to 99
04 100	Tissue and Dressing Forceps Chirurgische und Anatomische Pinzetten Pincés à tissus et à pansement Pinzas quirúrgicas y anatómicas Pinzette chirurgiche e anatomiche	Page 100 to 128
05 129	Hemostatic Forceps Towel Clamps Arterienklemmen Tuchklemmen Pincés hémostatiques Pincés à champs Pinzas hemostáticas Pinzas de camp Pinzette emostatiche Fissateli	Page 129 to 158
06 159	Atraumatic Vascular Clamps Atraumatische Gefäßklemmen Pincés vasculaires atraumatiques Pinzas vasculares atraumáticas Pinze vascolari atraumatiche	Page 159 to 210

TABLE OF CONTENTS

		Page #
07	Needle Holders Ligature Needles Nadelhalter Unterbindungsnadeln Porte-aiguilles Aiguilles à ligatures Porta-agujas Agujas para ligaduras Port'aghi Aghi per legature	Page 211 to 243
211		
08	Probes Cotton Applicator Sonden Watteträger Sondes Applicateur de coton Sondas Porta-algodón Sonde Portacotone	Page 244 to 249
244		
09	Retractors Retraktoren Écarteurs Separadores Divaricatori	Page 250 to 322
250		
10	Trocar Biopsy Needles Trokar Biopsienadeln Trocart Aiguilles pour biopsie Trocar Agujas para biopsia Trocar Aghi da biopsia	Page 323 to 329
323		
11	Elevators Periosteal Bone files Curettes Elevatoren Raspatorien Knochenfeilen Küretten Élévateurs Rugines périostiques Limes à os Curettes Elevadores Periostótomos Limas para hueso Curetas Elevatori Scollaperiosteo Lime per osso Curettes	Page 330 to 376
330		
12	Mallet Osteotome Bone Chisel Hämmer Osteotom Knochenmeißel Maillet Ostéotome Burin à os Martillo Osteotomo Cincel para hueso Martello Osteotomo Scalpello per osso	Page 377 to 396
377		
13	Bone surgery Laminectomy Knochenchirurgie Laminektomie Chirurgie osseuse Laminectomia Cirugía ósea Laminectomía Chirurgia ossea Laminectomia	Page 397 to 454
397		

TABLE OF CONTENTS

		Page #
14	ENT - Otolaryngology HNO - Heilkunde ORL - Oto-rhino-laryngologie ORL - Otorrinolaringología ORL - Otorinolaringoiatria	Page 455 to 490
455		
15	Ophthalmology Ophthalmologie Ophtalmologie Oftalmología Oftalmologia	Page 491 to 526
491		
16	Gynecology Urology Gynäkologie Urologie Gynécologie Urologie Ginecología Urología Ginecologia Urologia	Page 527 to 560
527		
17	Suction Tubes Saugkanülen Canules d'aspiration Cánulas de aspiración Cannule per aspirazione	Page 561 to 580
561		
18	Maintenance and Sterilization Wartung und Sterilisierung Entretien et Stérilisation Mantenimiento y Esterilización Manutenzione e Sterilizzazione	Page 581 to 583
581		
19	Addendum Nachtrag Ajout Anexo Aggiunta	Page 584 to 696
584		
AMI	Alphanumerical Index Alphanumerischen Index Index alphanumérique Indice alfanumérico Indice alfanumerico	Page 697 to 712
697		

15 - FG - 93

1

2

3

1

Product group or discipline

2

Consecutive number within the group are discipline

3

Size / Shape of instrument

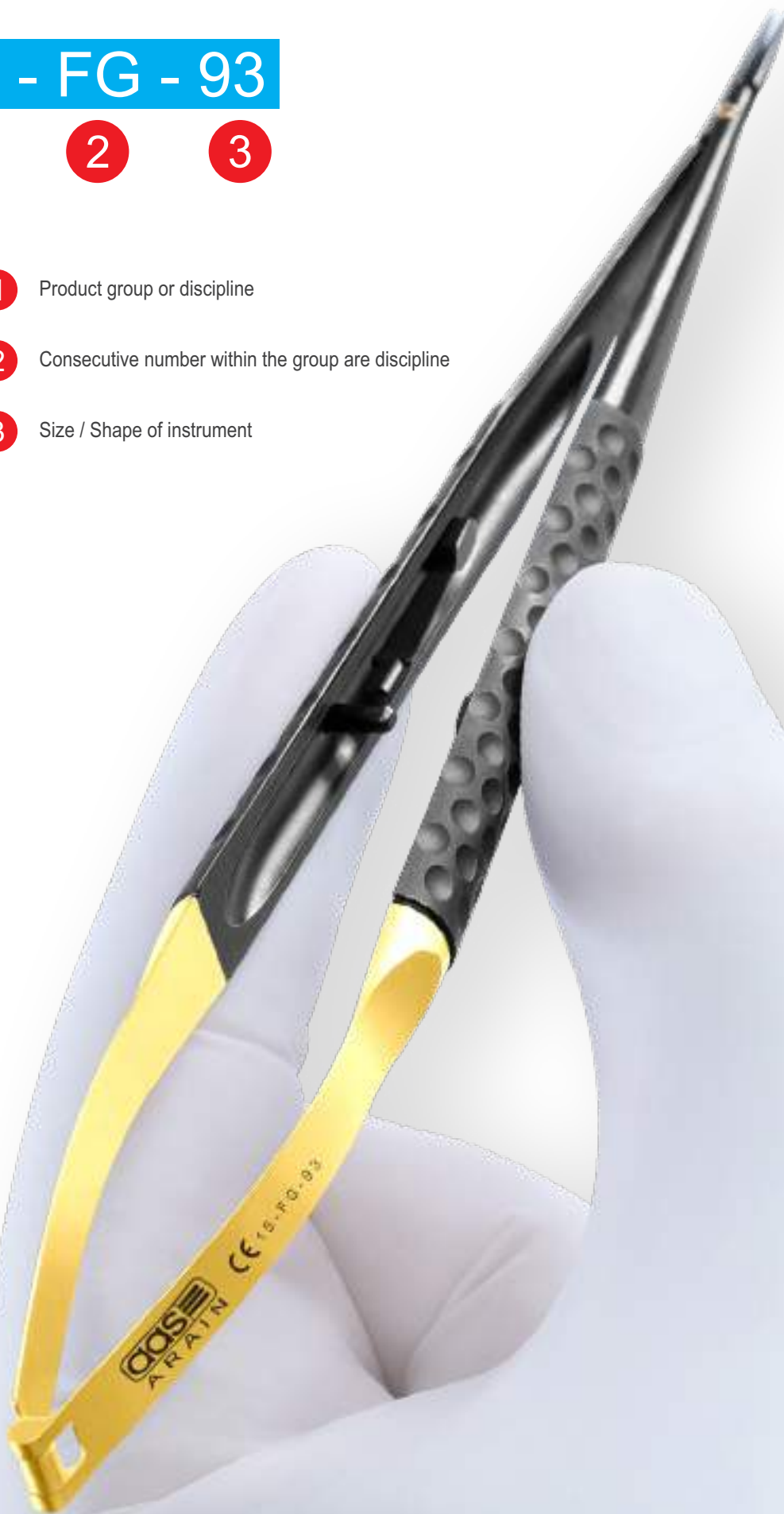

About Us

We are Manufacturer and Exporter of Surgical, Dental, Neuro, Cardiac & Hollowware instruments. Further we deliver today demand. We invite your Intention towards our passion and worth seeing instruments. Our belief is to create a single channel for satisfying diverse and high class needs of our valued partners.

We are highly flexible in responding to dynamic needs of our clients. We have a set of accurately devoted professionals who focus on their areas of specialties to fabricate highly valued products. We believe in joint venture not only with our customers but also with our workers who have proved to be a key in maintaining the uppermost level of excellence in our outputs. Our products are manufactured under suspicious executive of knowledgeable staff.

We are Spreading our Business all over the World. We export our products mostly in the United States, United Kingdom Germany, France, Italy, Spain, Canada, Australia, South Africa, Hong Kong, Singapore, Malaysia and Middle East Countries etc.

We believe that the policies we have been working along have given us a boost in our business and also created trust of our buyers in our company. We always welcome the feedbacks by our buyers and by no means hesitate to implement their variety suggestions to achieve new opportunities.

Our History

The journey of Arain & Son's Pvt.Ltd, began with the endeavors of our father Mr.Haji Mohammad Sharif back in the year 1960. He developed a vision to foresee a business opportunity.

Days and nights of toil, hard work and innovation led him to the manufacture of scissors, forceps and tweezers, and later the demand of his instruments marked.

This was a simple and inspired beginning of Arain & Son's Pvt.Ltd with a single-minded objective of 'providing high-quality instruments' for health and happiness of the world.

Today, Arain & Son's Pvt.Ltd, operates out of a purpose built manufacturing base in the City of Sialkot, extending over an area of 90,000 sq.ft.

These premises also house the Sales/Finance and Warehousing facilities. From the solid foundations created by our forefathers, the business has built a reputation for first class superior quality of surgical instruments in Pakistan.

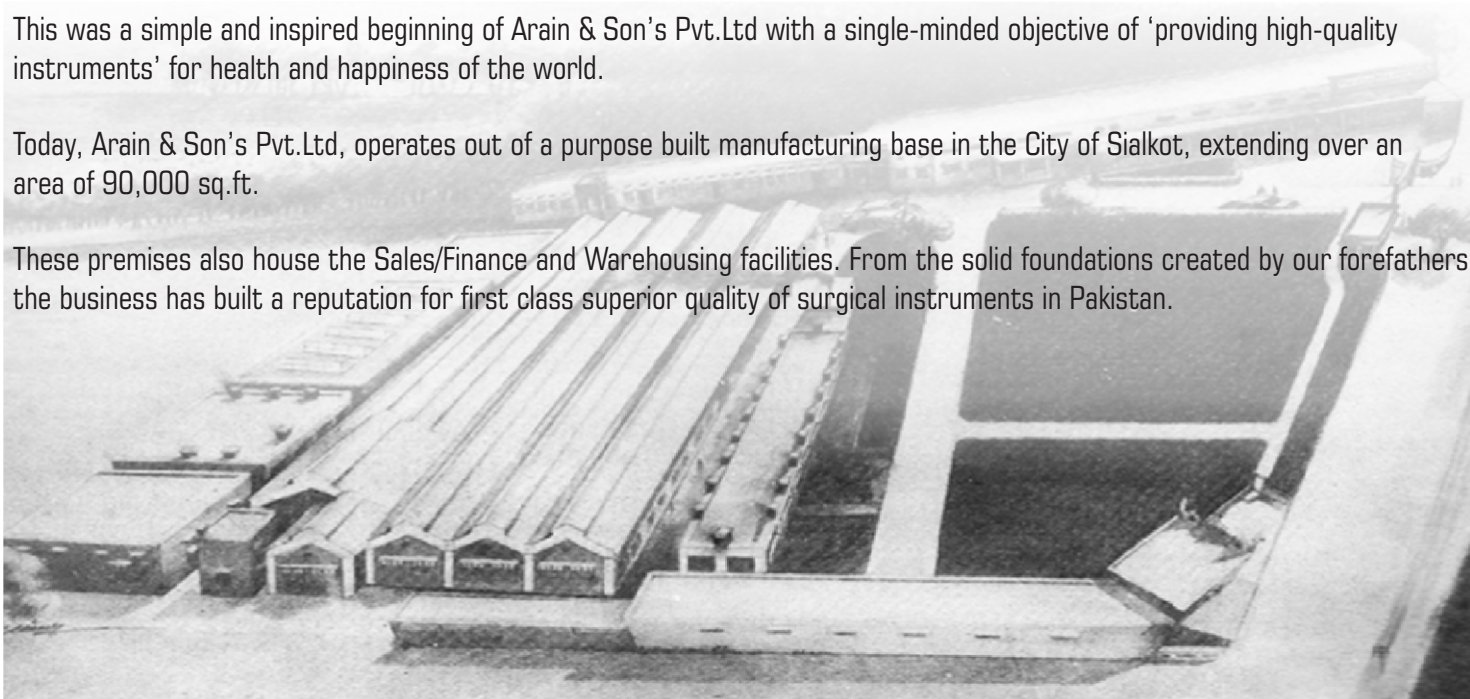

Arain & Son's Pvt, Ltd, Today

Arain & Son's Pvt. Ltd, holds the privilege of being the manufacturing pioneers of the finest quality of surgical, dental and accessories in Sialkot, Pakistan. We have a large customer base which comprises of private hospitals and clinics internationally, namely UK, USA and Germany among the many.

The constant advancements in equipment's & technology modern day knowledge with a mix of traditional skills of our experts, thus meeting the changing demands of modern surgery.

We offer prompt and dedicated service to customer, emphasizing of 'quality' and 'cost-effectiveness' in order to deliver products on budget and in time. Our commitment to quality is fulfilled based on continuous monitoring at every stage of manufacturing process, which has placed us at par with international standards. Our philosophy is to share our knowledge and experience with our customers and give them a strong foot in all the professional assistance they might need.

We believe in building a relationship with our customers and we extent all possible gestures to get continuous feedback from our customer, which creates courage and confidence to make improvements and development in products, paving way for growth. Today, Arain & Son's pvt. Ltd, operates out of a purpose built manufacturing base in the city of Sialkot.

Extending over an area of 170,000 sq.ft. These premises also house the Sales/ Finance and Warehousing Facilities. From the solid foundations created by our forefathers, the business has built a reputation for first class superior quality of surgical instruments in Pakistan. At present, through dedicated hard-work of the company, there is a substantial increase in business and international relations with clients throughout the world, building the business into a pinnacle of success in the modern world of surgery.

Our Mission

We will create new concept of market leadership. We are serving humanity with high quality, safe and durable products.

We will enhance this vision by giving exceptional after sales services and support to our clients. We will serve the mankind aiming to upgrade health care services and providing patients and doctors with latest and highest medical services quality.

Our Goals

Producing an internationally quality standard instruments. Improve our products quality and after sales services to meet the international standards.

Exceed our client's expectation and desire. Proving our credibility and reliability related to all technical as well as ethical aspects.

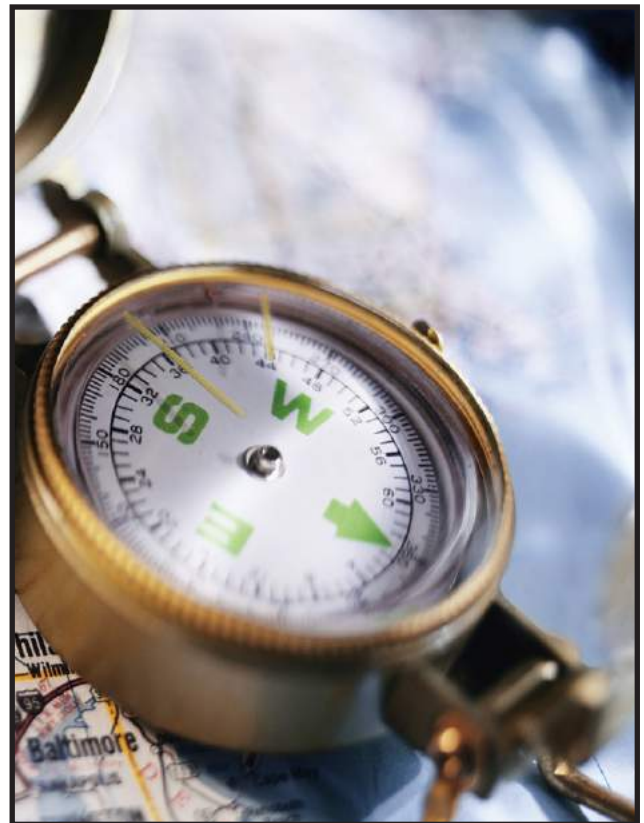

Company Policy

Arain & Son's Pvt. Ltd, Shall not compromise on quality of the products. We shall achieve quality excellence by using quality insurance programmers and techniques. Prompt and dedicated services shall be ensured to customers efficiently to the best of our abilities.

Commitment

Arain & Son's Pvt. Ltd, believes in the biggest moral values and business ethics. Once a contract is made with a customer, we strongly aim at following it in its true spirit regarding quality of product, packing, timing, or any other specific needs of the importer.

Workforce

We at Arain & Son's Pvt. Ltd, believe a highly qualified staff builds trust in a company. We are a strong team, consisting of strength. With a constant and steady growth the company now has a workforce consisting of 600 employees and 150 contractors.

Quality Management System

Arain & Son's Pvt. Ltd, manufacturing emphasizes on quality above all else. Our quality control team start by ensuring the best 410 and 420 stainless steel, making sure that it is properly stamped and forged and goes through a highly effective quality control.

Future Plans

Arain & Son's Pvt. Ltd, is expanding its production capacity due to increase in demand. We are redesigning our export house. As the competition in both local and international market is increasing day by day in order to cater this situation we our taking all our production in house.

Our complete milling shop is ready and we have over 200 milling machines currently in progress. As temper is a vital process to determine the hardness of the instruments we imported our own unit to give the desired hardness for the each instruments category. We invested over \$ 1.8 million dollars over the project and our new unit will start production in September 2018.

Expected Monthly Production Capacity

Different kind of Tweezers: 200,000

Different kind of Scissors, 100,000

Different kind of Forceps: 100,000

Different kind of Vaginal Speculum: 30,000

With the total of other instruments: 700,000



Production

We produce all kinds of operative line of Surgical, Dental, Micro Surgery and TC Instruments as well as Hollow ware.

Our ability to supply any instrument according to any international reference catalogue makes us unique service provider.



Hammer Workshop



Milling Workshop



Grinding



Filing Process



Polishing Workshop



Blade Sharpening

Production



Quality Control Department



Sterilizing & Ultrasonic



Laser Marking & Engraving



Packaging Hall



Stock Room



Export Warehouse



Under Construction Will be complete in Sep. 2018

Different Kinds of Finishing

Standard Finish {Matt Finish} {Dull Finish}

Instruments with their real original stainless steel image supported by a satin/dull finish with minimal light reflection. Those instruments are the standard used by all surgeons everywhere. You can easily find different varieties and different specialties available on our stock.



Mirror Finish {Shine Finish} {Polish Finish}

Standard finish made of high quality stainless steel provided in a shiny mirror finish. Those instruments are made upon customer request to have this unique image and shine of silver. It gives the instrument a shape of dignity.



Black Finish {Plasma Coating} {Titanium Coating}

Black instruments are recommended for use in Micro Surgeries, under microscope, as well as in large operating fields using large instruments such as big retractor. The black colour finish is very effective in preventing light reflection during surgeries and making them convenient for surgeons. Surgeons, who have used such instruments, expressed their feeling with comfort and relaxation after surgery. It is important to insure the stability of the black colour with frequent use of autoclaves and sterilization process.



Extra Finish Line

In this way we can satisfy our customer who would like to make special marks/logos on their instruments. Upon special request we can make one instrument with two types of finishes. In this way, one part of the instrument will be in mirror finish and the other part will be in satin, black or gold finish.



Product Range

Hollow ware

A big variety of hollow wares (sterilization boxes, trays, kidney dishes and bowls) with different varieties in sizes and shapes.



Dental Instruments

Titanium and aluminum instruments are also available on request.

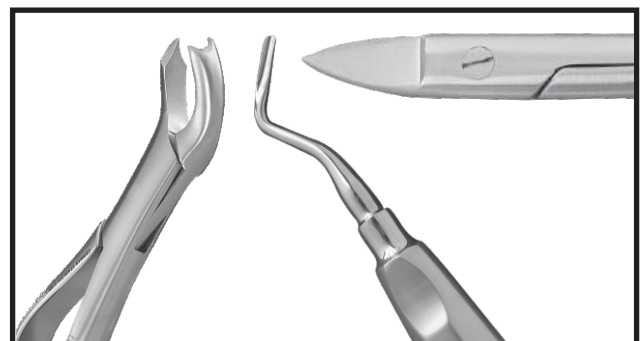

Product Range

Surgical Instruments

Ligatures, catheters and tapes handling, during surgical procedures are a delicate art. In most of the time, it needs assistant with three-dimensional orientation



TC Instruments

In Surgical and Dental and other Medical Instruments.



Micro Surgery Instruments

A huge range of micro surgery instruments include, Micro Scissors, micro needle holders, delicate forceps, nerve Hooks, micro vessel clips, brain retractor, etc. with different varieties in sizes and shapes.

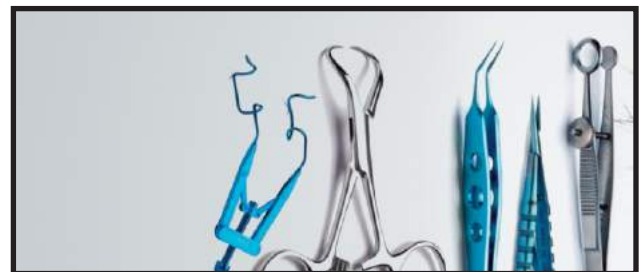

Product Range

A Complete Range of Diagnostic Instruments
Laryngoscopes and Otoscopes.



Veterinary Instruments



After Sales Services

When you are buying Arain & Son's Pvt.Ltd., you are not only buying quality medical instruments but also getting our special services.

Long-term warranty against defects in materials or workmanship.

Immediate replacement for any instruments proves defect in material or workmanship.

Free periodic maintenance.

Instruments repair services.

Repair exchange services.

Training your staff for regular medical instruments maintenance.

Insurance against damage for medical instruments.

Huge range of medical instruments stock at your demand.

Execute your own instruments' design and ideas.

Manufacturing according to our own catalogue or any others as well.



Quality Control

We manufacture our products according to the international standards

We also enhanced our quality with high quality certificates

ISO 9000-2000 / 13458

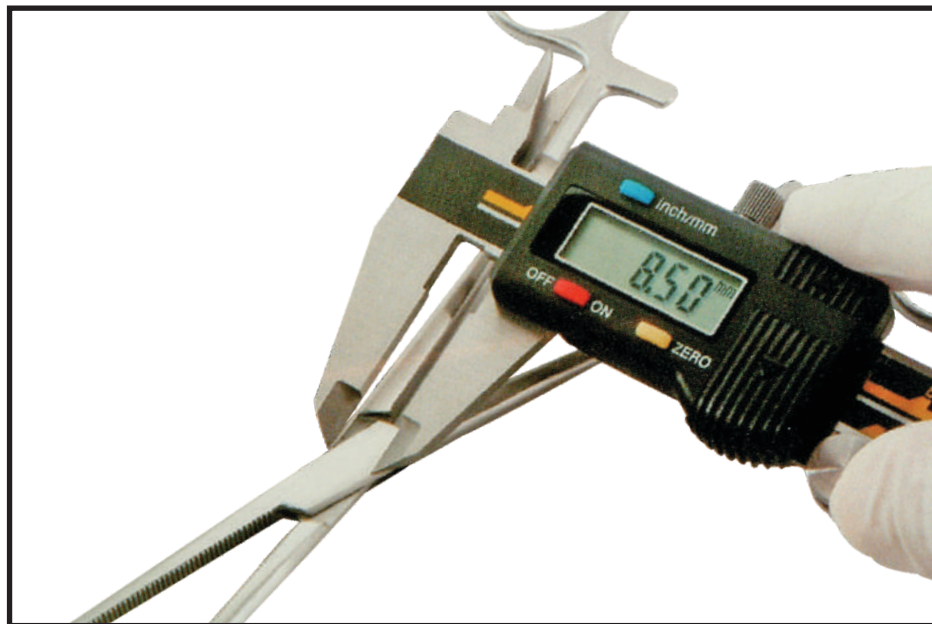

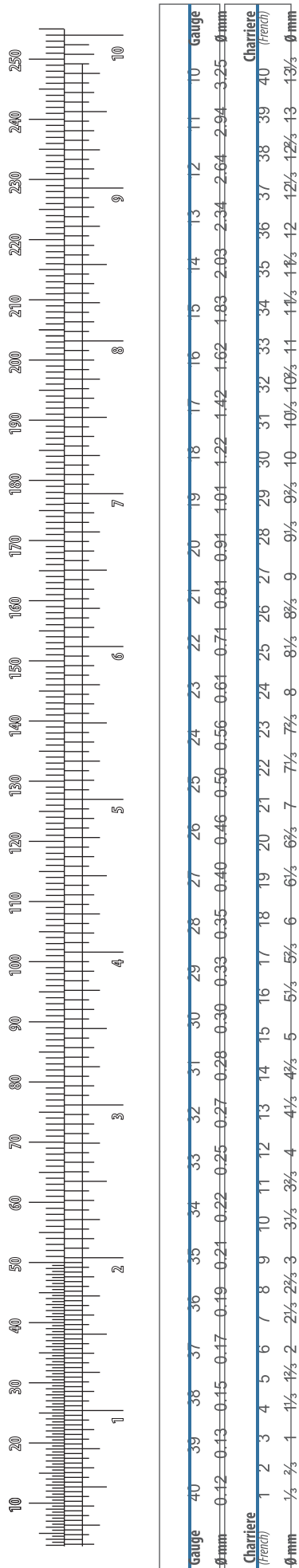

Forceps
Pinzetten | Pincas | Pinzas | Pinzette

Regular
Standard
Régulier
Regular
Regolare

1x2 Teeth
Zähne
Dents
Dientes
Denti

Scissors
Scheren | Ciseaux | Tijeras | Forbici

Regular Edge

SUPER CUT Edge

Super Cut Scissors have specially designed cutting edges. One regular edge and **one sharp-knife edge**.

Extremely Sharp Razor Edge / Atraumatic
Extrem Scharfe Spitzer Beck / Atraumatische
Tranchant extrêmement aiguisée / Atraumática
Borde extremadamente afilado / Atraumática
Taglio estremamente affilato / Atraumatica

Tungsten-Carbide Inserts
Mit Hartmetalleinsätzen
Plaquettes en carbure de tungstène
Plaquetas de carburo de tungsteno
Inserti in carburo di tungsteno

Sharp
Scharfe
Aiguisé
Afilado
Tagliente

Regular
Régulier
Regular
Regular
Regolare

Serrated
Gezähnt
Dentado
Dentellato

One side serrated
Eine seite gezähnt
Un côté dentelé
Un lado dentado
Un lato dentellato

Pointed
Spitz
Pointu
Puntiagudo
Acuto

Blunt
Stumpf
Épointé
Romo
Smusso

Needle Holders
Nadelhalter | Porte-aiguilles | Portaaguas | Port'aghi

R **Regular**
Standard
Régulier
Regular
Regolare
Suture Ø 2.0 ~ 4.0

M **Micro**
Mikro
Micro
Micro
Micro
Suture Ø 6.0 ~ 9.0

F **Fine**
Fein
Fin
Fino
Fine
Suture Ø 4.0 ~ 6.0

S **Smooth**
Glatt
Lisse
Liso
Liscia
Suture Ø 7.0 ~ 10.0

Metal |Metalle | Métal | Metal | Metallo

TC **Tungsten-Carbide Inserts**
Mit Hartmetalleinsätzen
Plaquettes en carbure de tungstène
Plaquetas de carburo de tungsteno
Inserti in carburo di tungsteno

inox **Stainless Steel**
Rostfreier Stahl
Acier inoxydable
Acero inoxidable
Acciaio inossidabile

Ti **Titanium**
Titan
Titane
Titanio
Titanio

Al **Aluminium**
Aluminium
Aluminium
Aluminio
Alluminio

Ag **Silver**
Silber
Argent
Plata
Argento

Cr **Chromium**
Chrom
Chrome
Cromo
Cromo

Ni **Nickel**
Nickel
Nickel
Niquel
Nickel



1 Inch is equal to

International System of Units - Imperial Units -	SUnit	SI	Imperial
0.254 m	1 millimetre		0.0394 in
2.540 cm	1 centimetre		0.3937 in
25.40 mm	1 metre		1.0936 yd
100 points	Imperial	Imperial	SI
1,000 thou (mil)	1 inch		2.540 cm
1,000,000(µin)	1 foot	12 in	30.48 cm
0.02778 yards	1 yard	3 ft	91.440 cm

Inches Millimetres	Fractional and Decimal Inches Millimetres			
	Mm	Fractional	Decimal	Mm
0.001	0.0254	1/64	0.0156	0.3969
0.002	0.0508	1/32	0.0313	0.7938
0.003	0.0762	1/16	0.0625	1.5875
0.004	0.1016	1/8	0.1250	3.1750
0.005	0.1270	3/16	0.1875	4.7625
0.006	0.1524	1/4	0.2500	6.3500
0.007	0.1778	5/16	0.3125	7.9375
0.008	0.2032	3/8	0.3750	9.5250
0.009	0.2286	7/16	0.4375	11.1125
0.010	0.2540	1/2	0.5000	12.7000
0.011	0.2794	9/16	0.5625	14.2875
0.012	0.3048	5/8	0.6250	15.8750
0.013	0.3302	11/16	0.6875	17.4625
0.014	0.3556	3/4	0.7500	19.0500
0.015	0.3810	13/16	0.8125	20.6375
0.016	0.4064	7/8	0.8750	22.2250
0.017	0.4318	15/16	0.9375	23.8125
0.018	0.4572	1	1.0000	25.4000
0.019	0.4826			
0.020	0.5080			
0.021	0.5334			
0.022	0.5588			

Celsius	Fahrenheit	Inches	
		Centimetres	
°C	°F	In	Cm
0	32	1	2.54
10	50	2	5.08
20	68	3	7.62
30	86	4	10.16
40	104	5	12.7
50	122	6	15.24
60	140	7	17.78
70	158	8	20.32
80	176	9	22.86
90	194	10	25.40
100	212	11	27.94
110	230	12	30.48
120	248	13	33.02
130	266	14	35.56
140	284	15	38.10
150	302	16	40.64
200	392	17	43.18

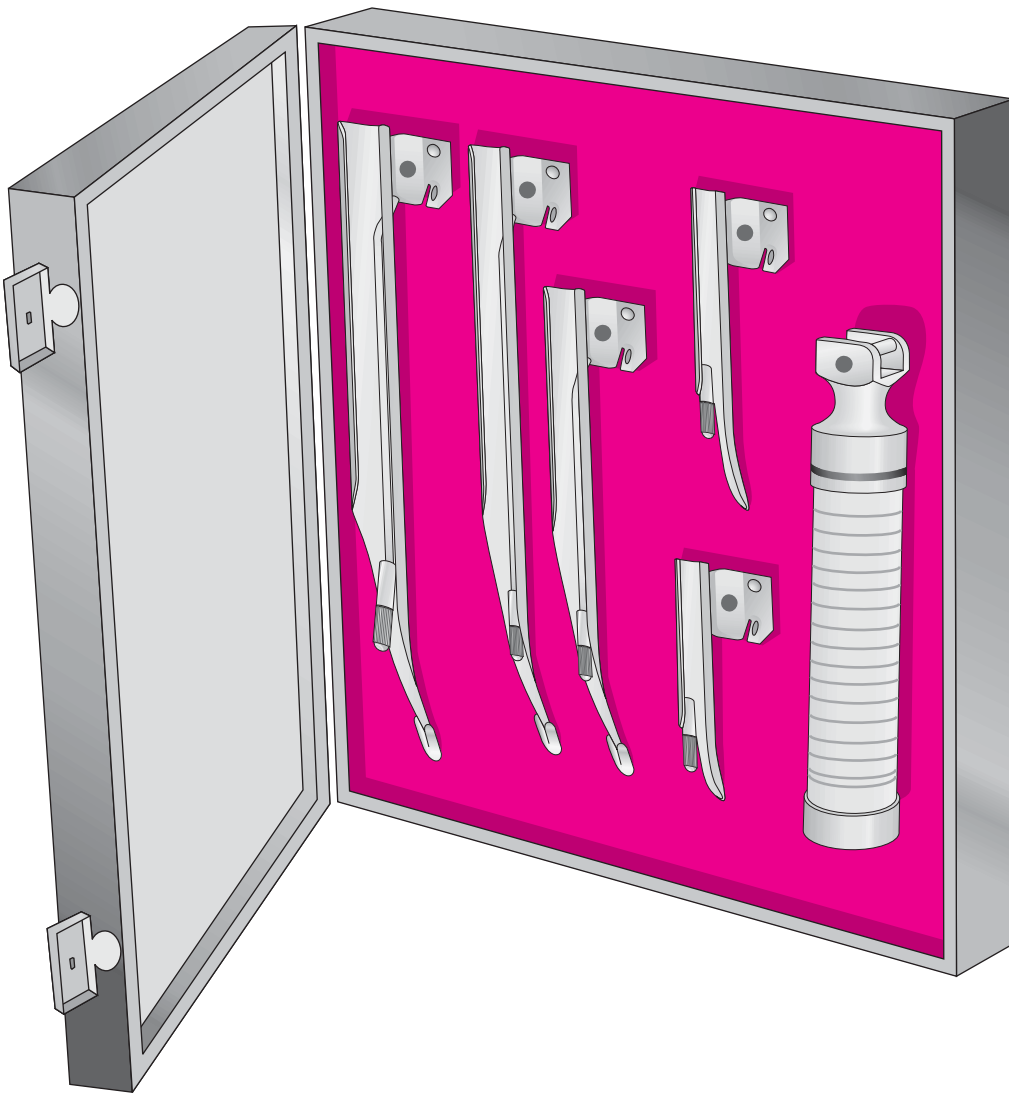

01 |

Diagnosis | Anesthesia

Diagnose | Anästhesie

Diagnostic | Anesthésie

Diagnóstico | Anestesia

Diagnosi | Anestesia

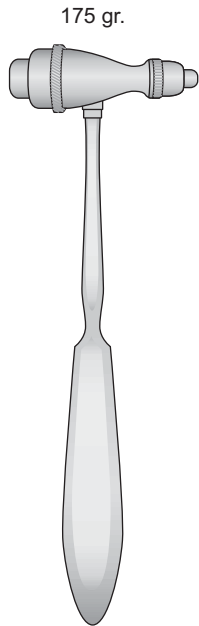

TROEMNER
AB-16
140 mm

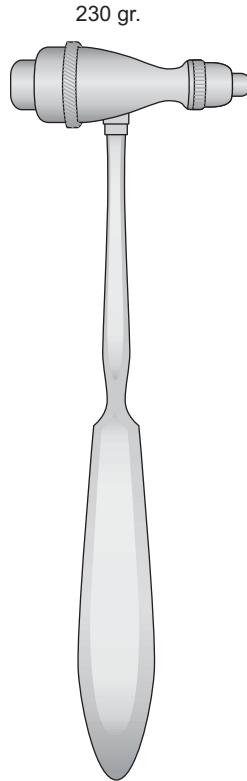

TROEMNER
AB-18
240 mm

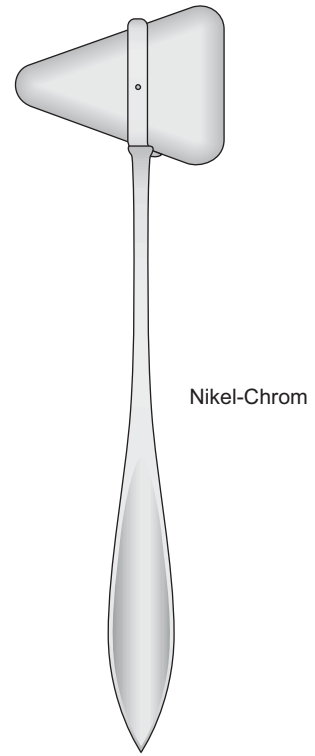

TAYLOR
AB-14
200 mm

Con ago - With pin
Mit nadel - Avec aiguille
Con aguja

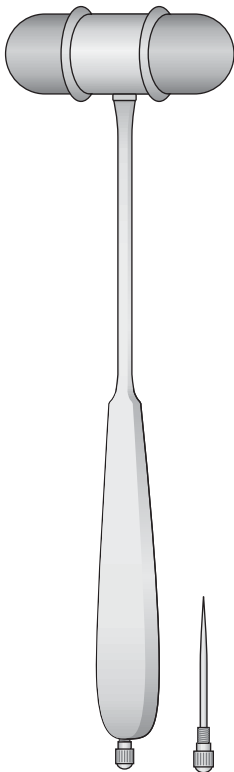

DEJERINE
AB-10
200 mm

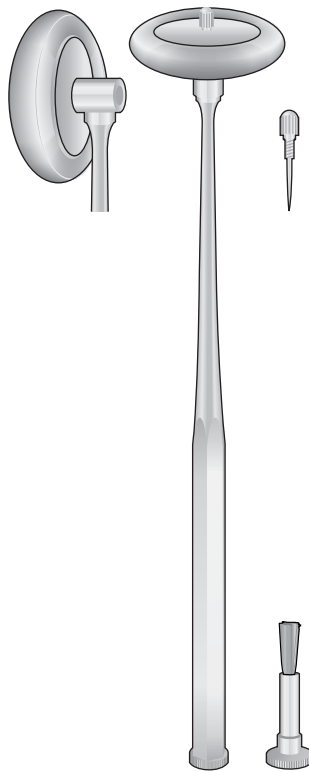

BABINSKY
AB-11
255 mm

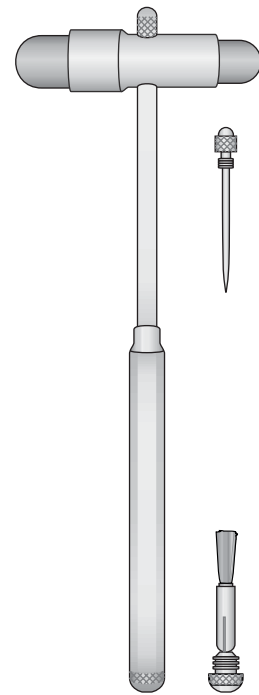

BUCK
AB-12
180 mm

01

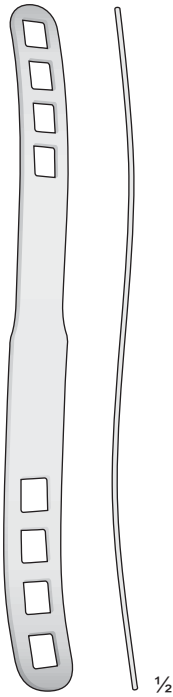

BRUENINGS
OM-04
190 mm

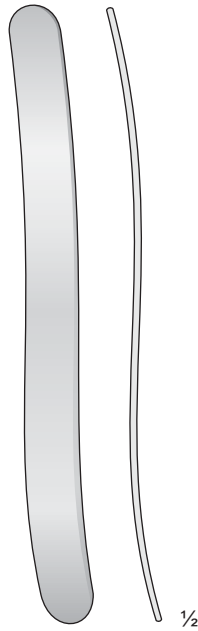

OM-05
145 mm

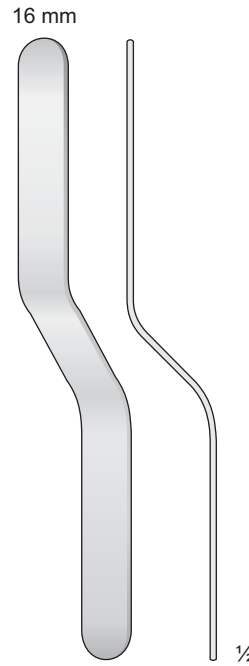

OM-07
145 mm

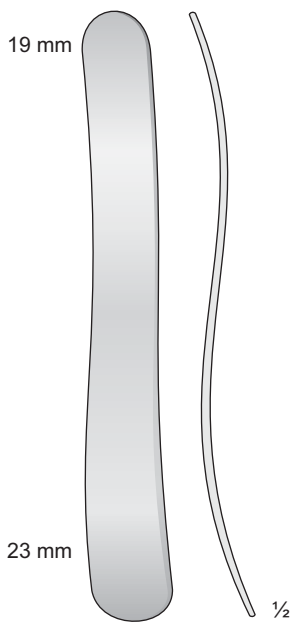

KROENIG
OM-16
150 mm

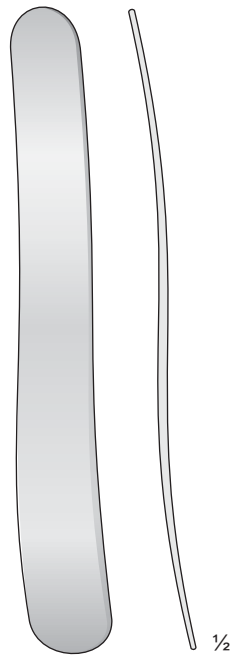

MAYO
OM-17
170 mm

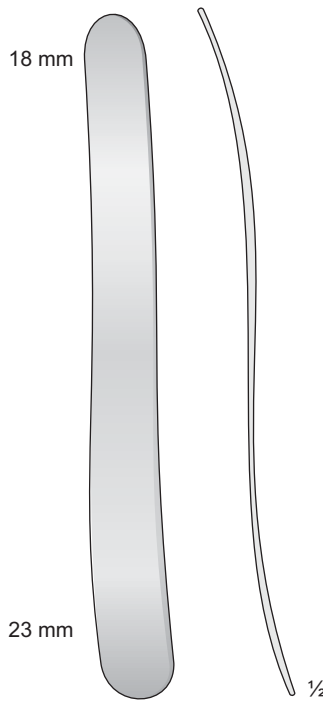

BUCHWALD
OM-18
180 mm

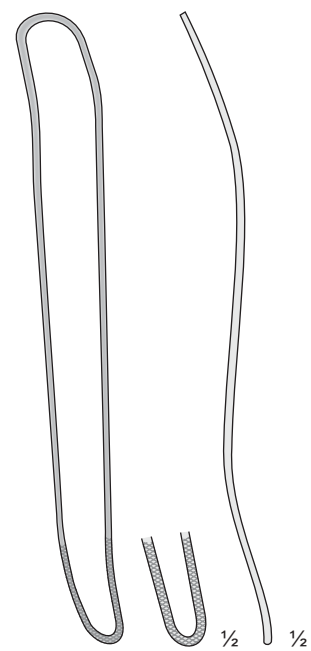

FRENZEL
OM-19
165 mm



AC-20

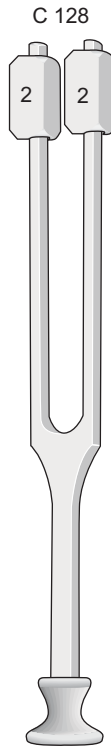

LUCAE AC-30

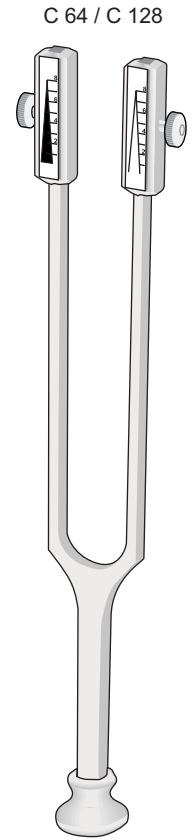
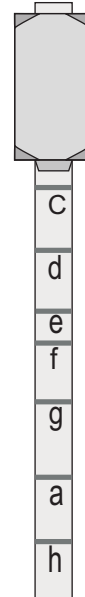

RYDEL-SEIFER AC-40

C 64
Con smorzatore - With clamps
Mit Dämpfer - Avec curseurs
C 128
Senza smorzatore - Without clamps
Ohne Dämpfer - Sans curseurs

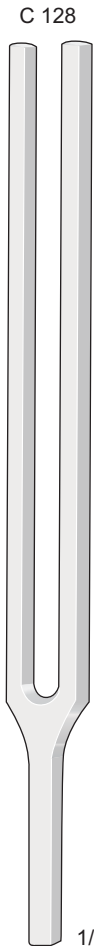

HARTMANN AC-11

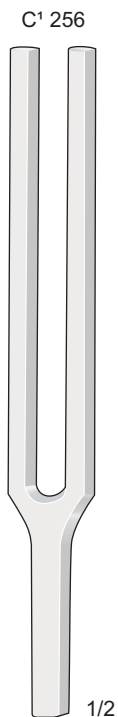

HARTMANN AC-12

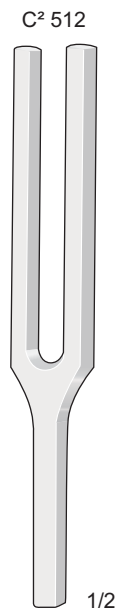

HARTMANN AC-13

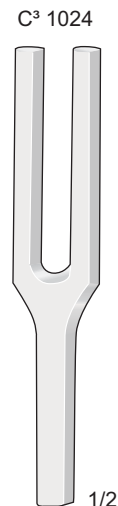

HARTMANN AC-14

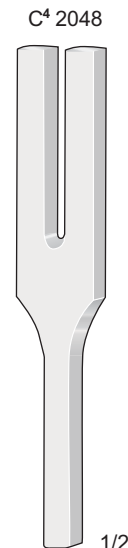

HARTMANN AC-15

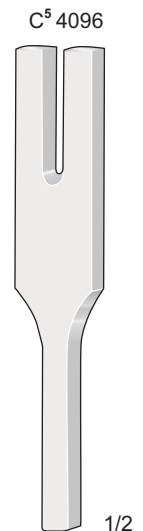

HARTMANN AC-16

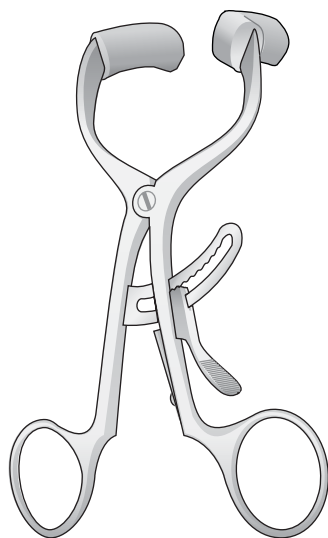

DOYEN-JANSEN
OM-41
140 mm

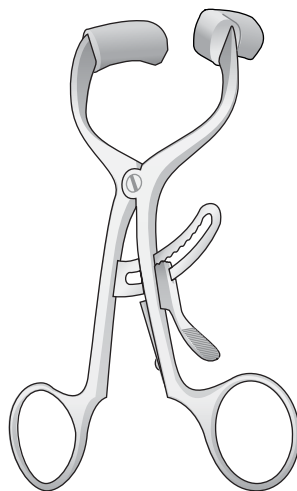

DOYEN-COLLIN
OM-40
120 mm

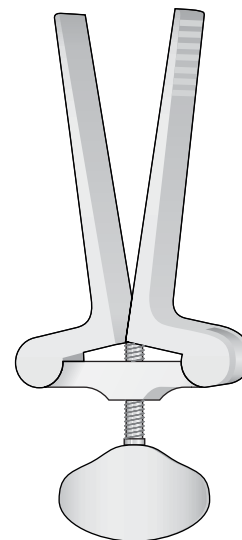

HEISTER
OM-62
135 mm

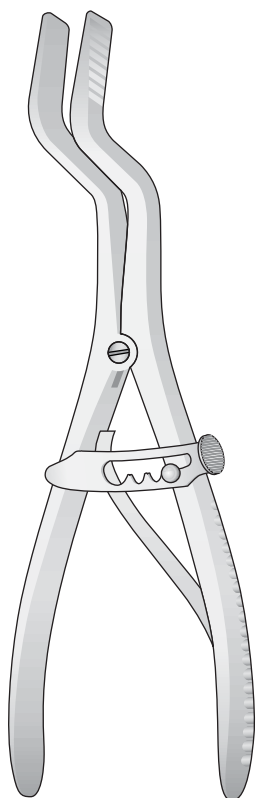

ROSER-KÖNIG
OM-60
185 mm

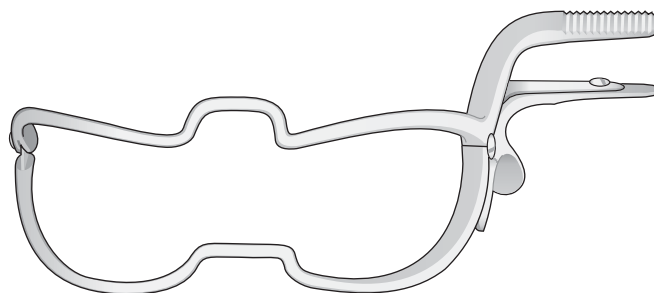

WHITEHEAD-JENNINGS
OM-136 90 mm
OM-137 110 mm
OM-138 130 mm
OM-139 150 mm

Anesthesia - Anesthesia
Anaesthesia - Anesthésie - Anestesia



OM-12
150 mm

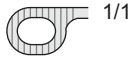

OM-13
200 mm

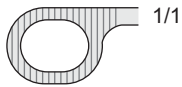

OM-14
250 mm

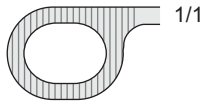

OM-15
250 mm

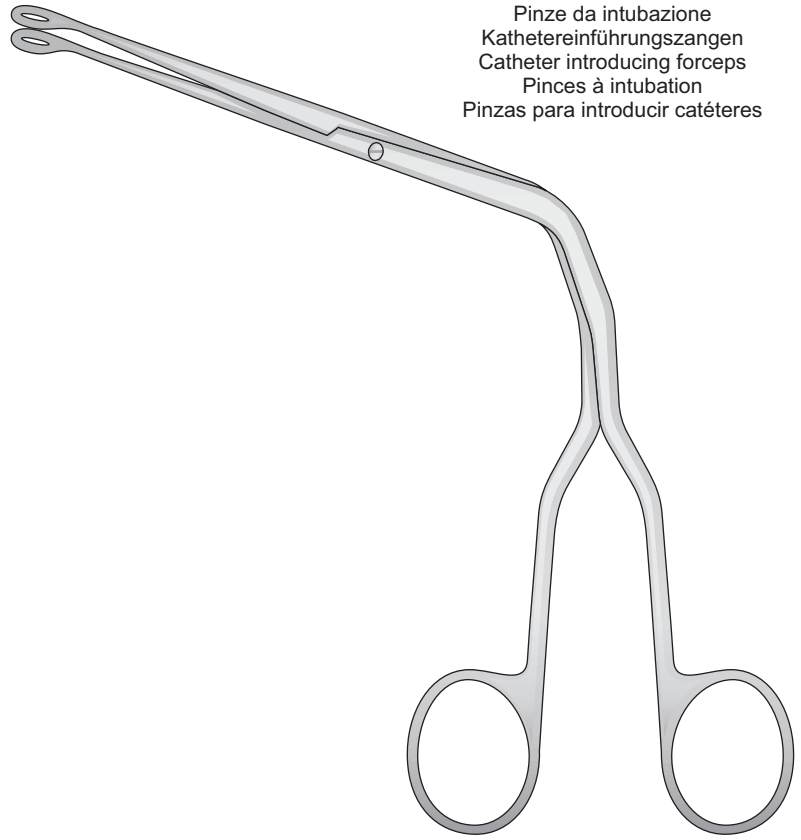

Pinze da intubazione
Kathetereinführungszangen
Catheter introducing forceps
Pinces à intubation
Pinzas para introducir catéteres

MAGILL
OM-12/OM-15

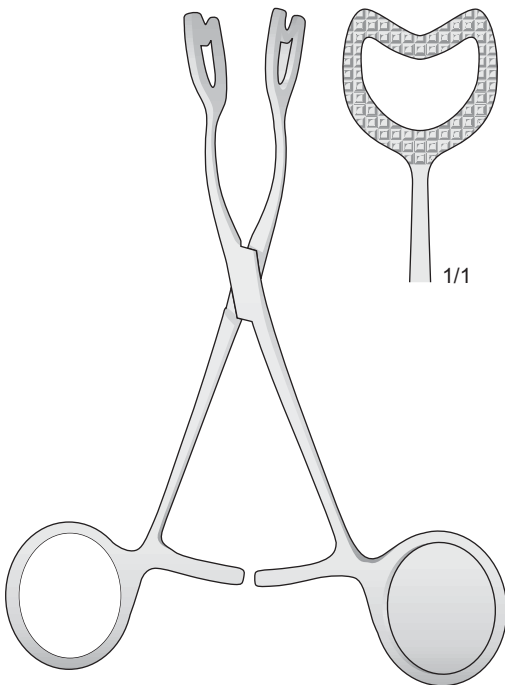

OM-11
140 mm

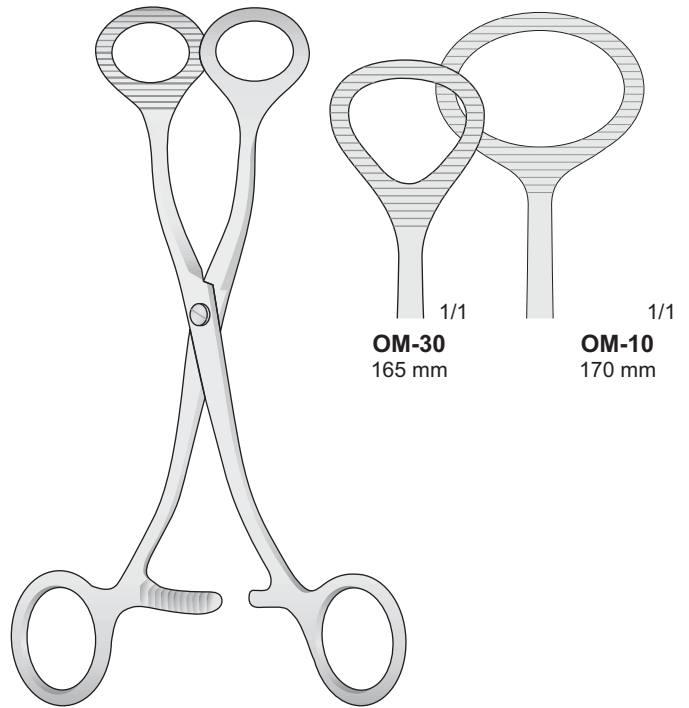
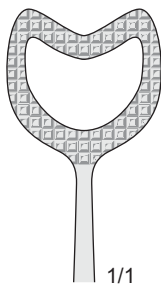

OM-30
165 mm

OM-10
170 mm

COLLIN
OM-10/OM-30

01



ARAIN & SON'S

Gomini di ricambio 2 pezzi
 1 Pair of rubber pads
 1 Paar ersatzgummi
 1 Paire de mors caoutchouc
 1 Paar placas de caucho

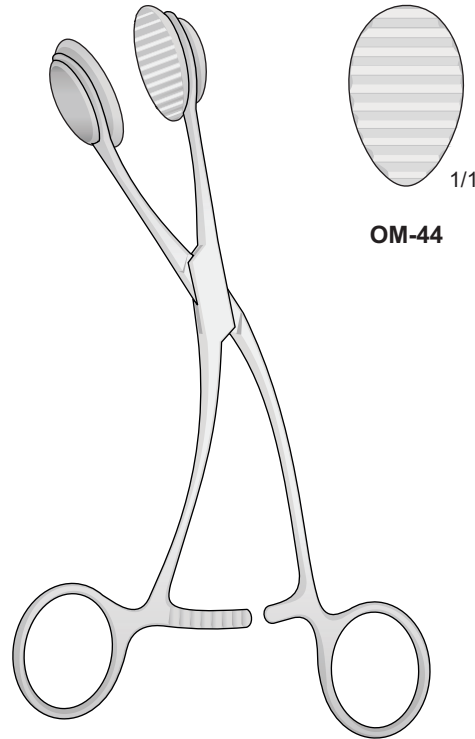

OM-44

Pinza per batuffoli e tamponi
 Cotton swab-Sponge holding forceps
 Tupfer-Schwammzangen
 Pinces à tampons et è ponges
 Pinzas para tampones porta esponjas

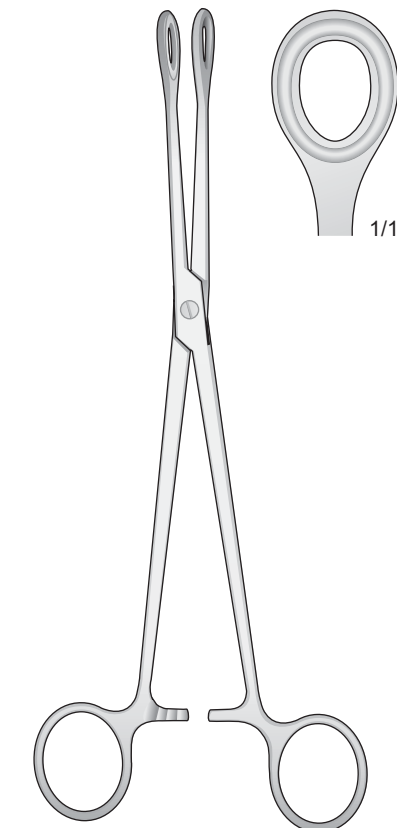

BF-16
 230 mm

YOUNG
 OM-45
 160 mm

Gomini di ricambio 2 pezzi
 1 Pair of rubber pads
 1 Paar ersatzgummi
 1 Paire de mors caoutchouc
 1 Paar placas de caucho

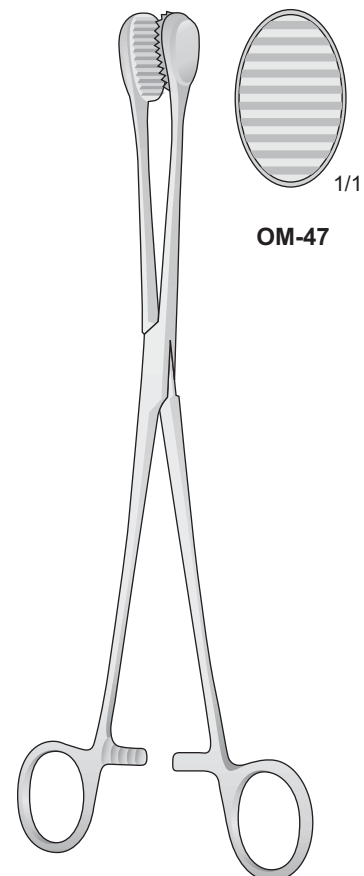

OM-47

CHILD
 OM-46
 240 mm

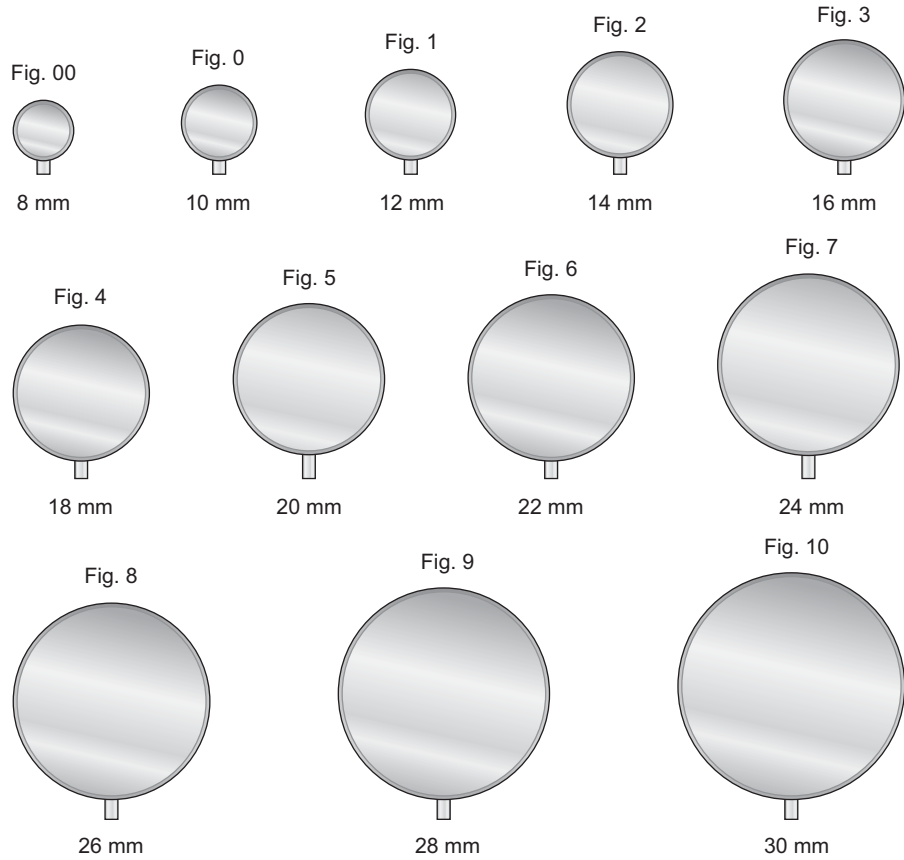

Specchietto laringeo con manico esagonale
Laryngeal mirrors with hexagonal handle
Miroirs laryngiens avec manche hexagonal

Inox

Diametro dello specchio - Diameter of mirrors - Spiegeldurchmesser
Diamètre des miroirs - Diámetro de los espejos

Manico per specchietti
Mirrors handle
Spiegelgriff
Manche à miroir
Manico para espejos

Nikel-Chrom

Specchietto laringeo
Laryngeal mirrors
Kehlkopfspiegel
Miroirs laryngiens
Espejos laringeos

	Fig.
G- 8	00
G-10	0
G-12	1
G-14	2
G-16	3
G-18	4
G-20	5
G-22	6
G-24	7
G-26	8
G-28	9
G-30	10

	Fig.
P-00	00
P- 0	0
P-01	1
P-02	2
P-03	3
P-04	4
P-05	5
P-06	6

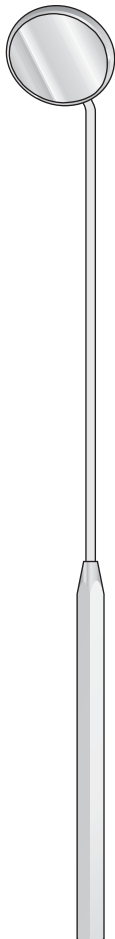

G-8/G-30
180 mm

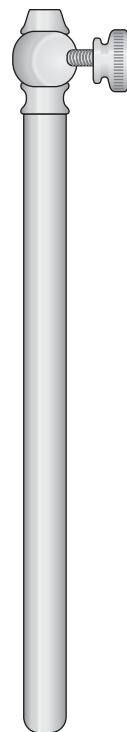

MA-6
120 mm

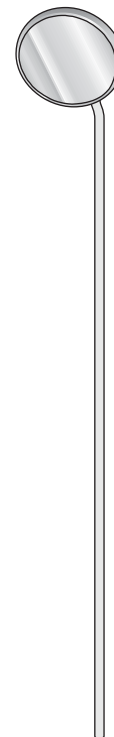

P-00/P-06
120 mm

Duofono pediatrico
Con 4 olive di ricambio

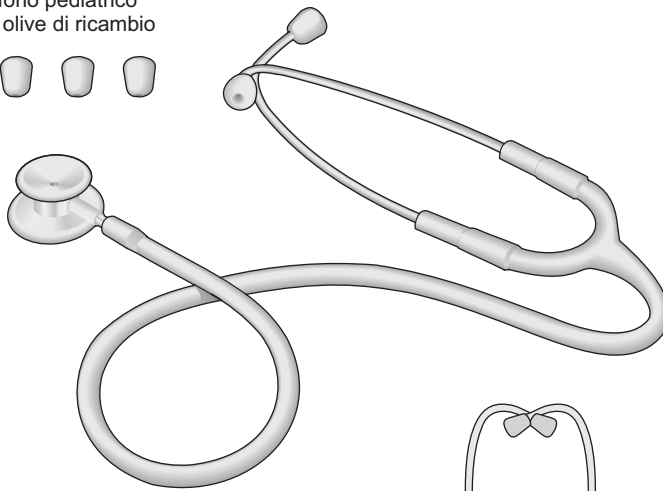

AB-54

In legno
Of wood
Aus Holz
En bois
De madera



AB-55
145 mm

Professional
Con 4 olive di ricambio



LEVIS - CLASSIC
AB-52

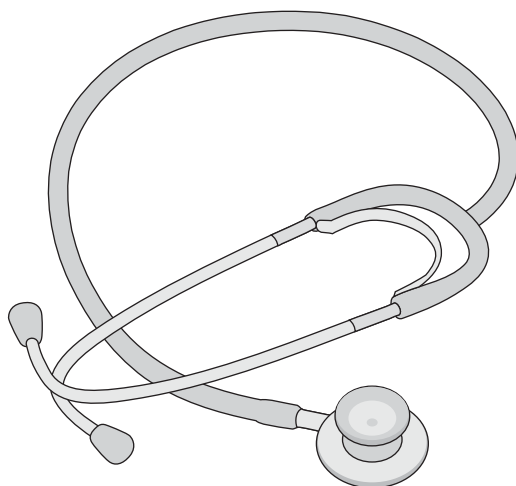
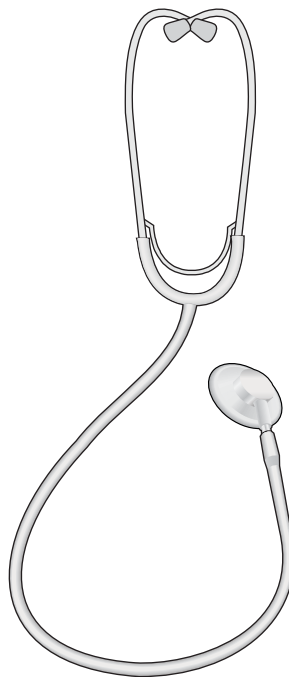

AB-50

Fonendoscopio
Classic

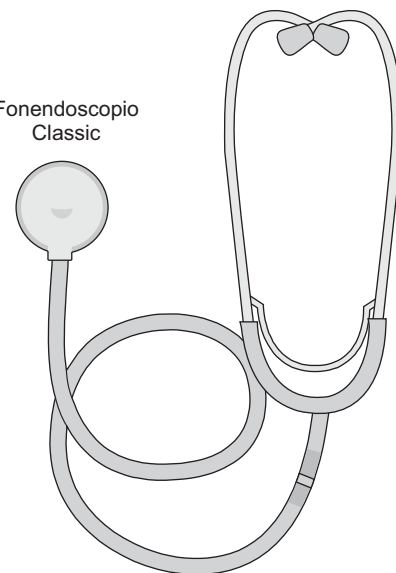

AB-51

Laringoscopio
MC INTOSH



AA-B100
2,5 Volt
300 mA
Per lama **AA-100**
For blades **AA-100**
Für Spatel **AA-100**
Pour spatules **AA-100**
Para hojas **AA-100**



AA-B101
2,5 Volt
300 mA
Per lame **AA-101 ÷ AA-104**
For blades **AA-101 ÷ AA-104**
Für Spatel **AA-101 ÷ AA-104**
Pour spatules **AA-101 ÷ AA-104**
Para hojas **AA-101 ÷ AA-104**

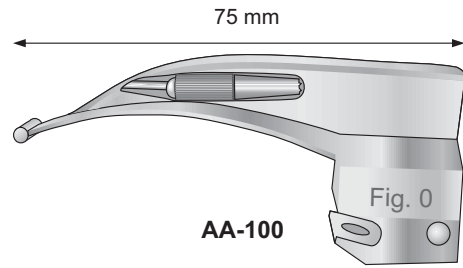

AA-100

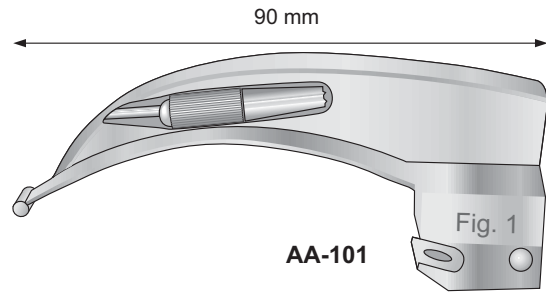

AA-101

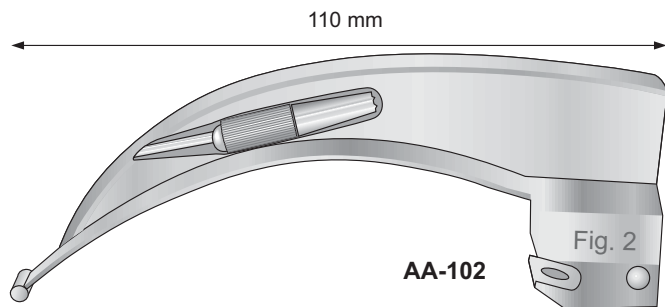

AA-102

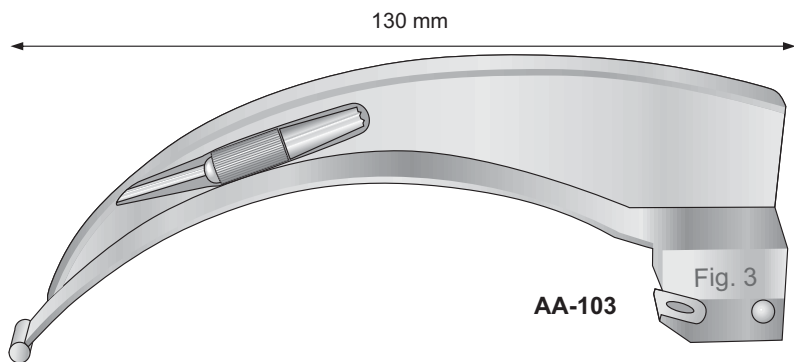

AA-103

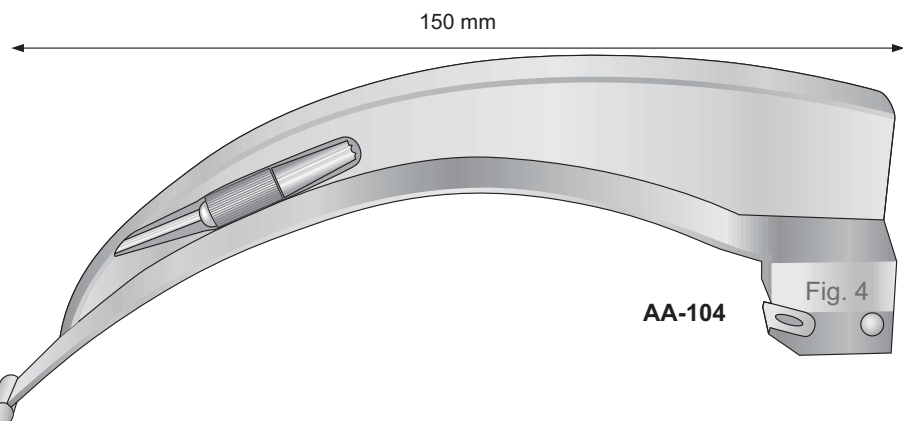

AA-104

01



Laringoscopio
MILLER

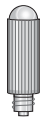

AA-B100
2,5 Volt
300 mA

Per lame **AA-200 + AA-203**
For blades **AA-200 + AA-203**
Für Spatel **AA-200 + AA-203**
Pour spatules **AA-200 + AA-203**
Para hojas **AA-200 + AA-203**



AA-B101
2,5 Volt
300 mA

Per lama **AA-204**
For blades **AA-204**
Für Spatel **AA-204**
Pour spatules **AA-204**
Para hojas **AA-204**

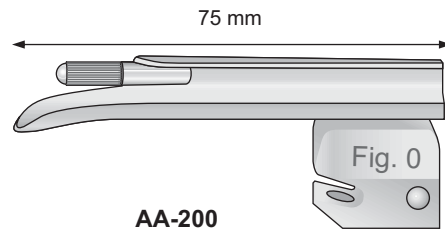

AA-200

Fig. 0

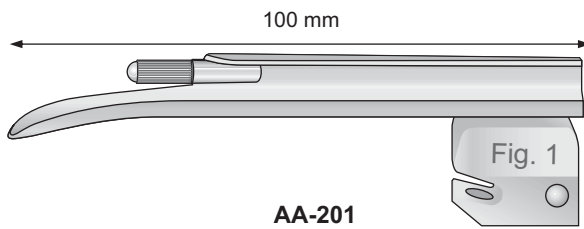

AA-201

Fig. 1

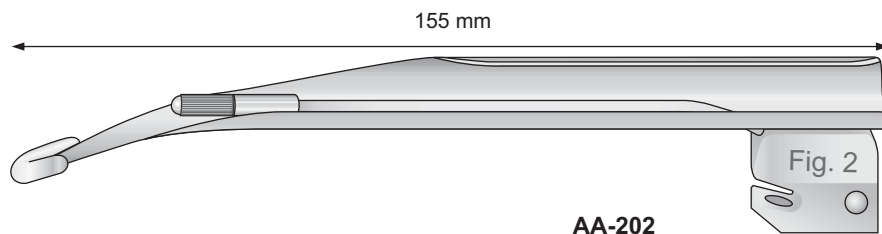

AA-202

Fig. 2

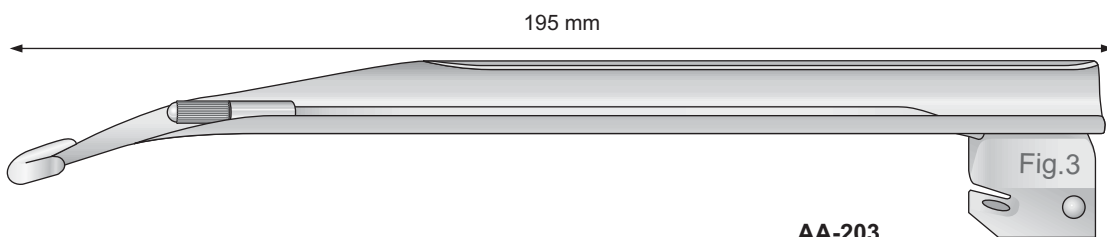

AA-203

Fig. 3

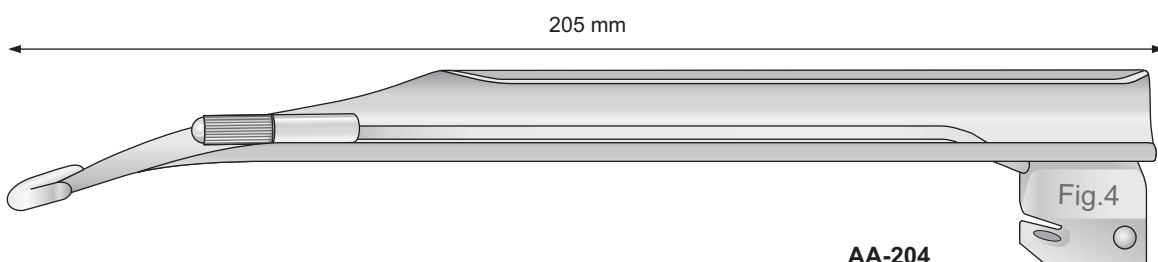

AA-204

Fig. 4

Laringoscopio
NEGUS - GUEDEL

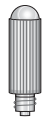

AA-B100

2,5 Volt
300 mA

Per lama **AA-401**
For blades **AA-401**
Für Spatel **AA-401**
Pour spatules **AA-401**
Para hojas **AA-401**

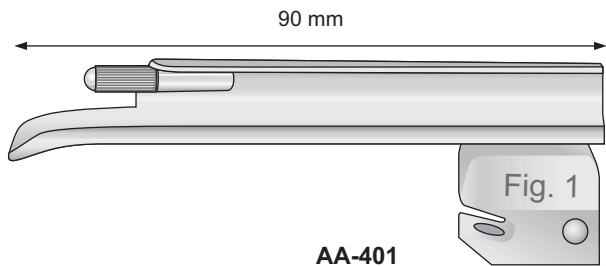

AA-B101

2,5 Volt
300 mA

Per lama **AA-402 ÷ AA-404**
For blades **AA-402 ÷ AA-404**
Für Spatel **AA-402 ÷ AA-404**
Pour spatules **AA-402 ÷ AA-404**
Para hojas **AA-402 ÷ AA-404**

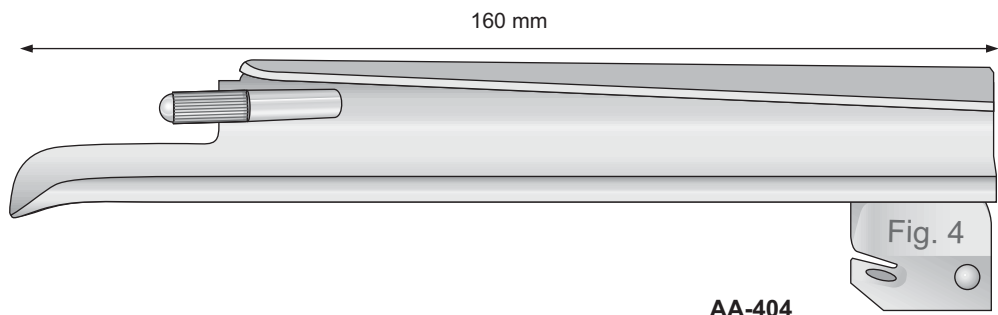
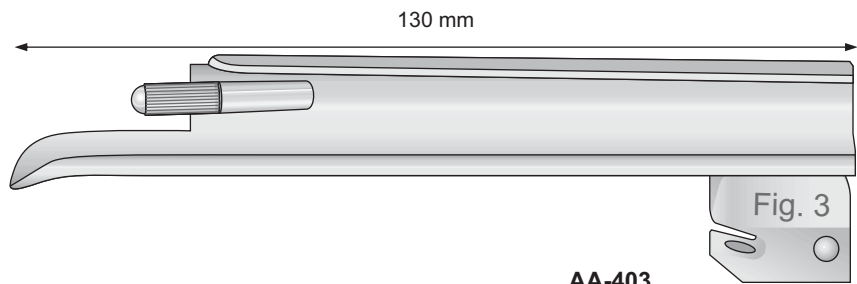
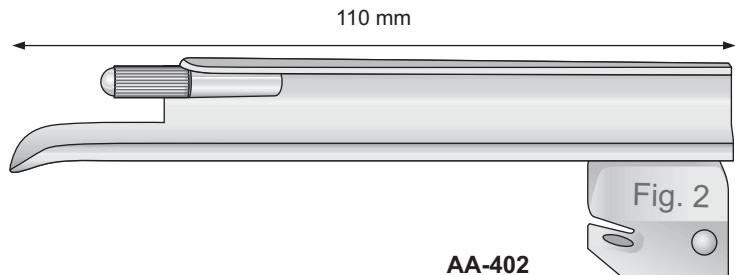

01



Laringoscopio
MC INTOSH

Fibre ottiche
Fiberoptic

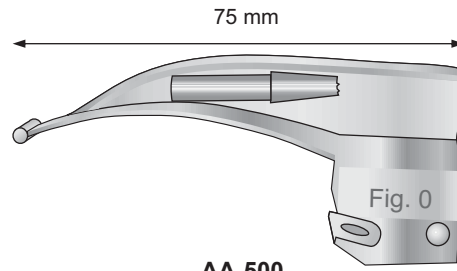
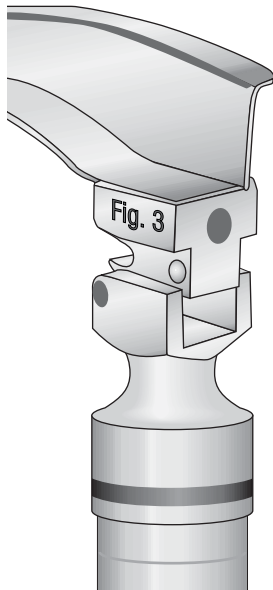

AA-500

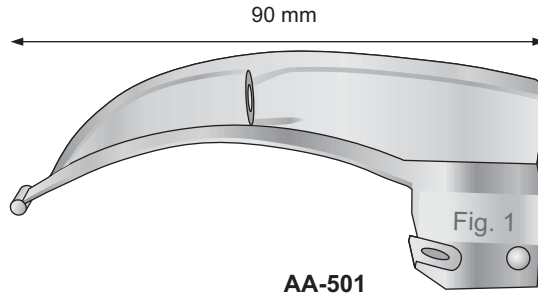

AA-501

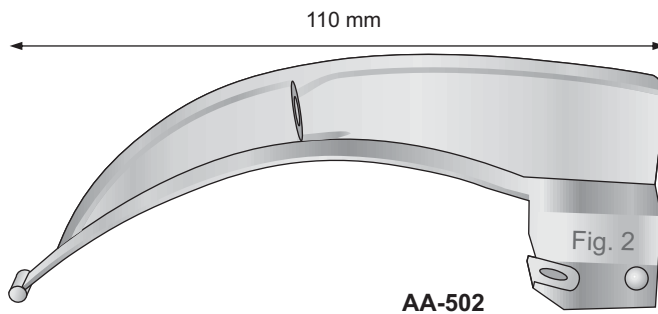

AA-502

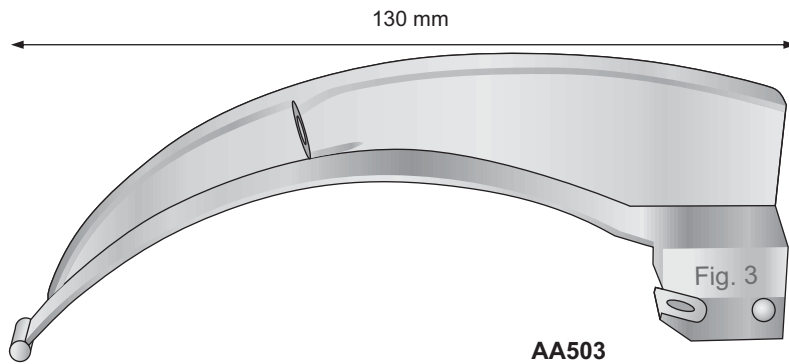

AA503

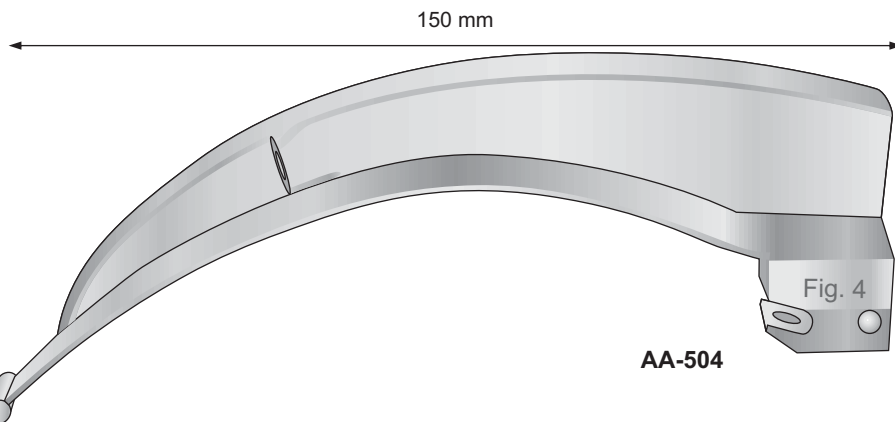

AA-504

Laringoscopio
MILLER

Fibre ottiche
Fiberoptic

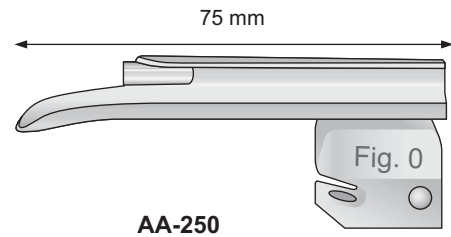

AA-250

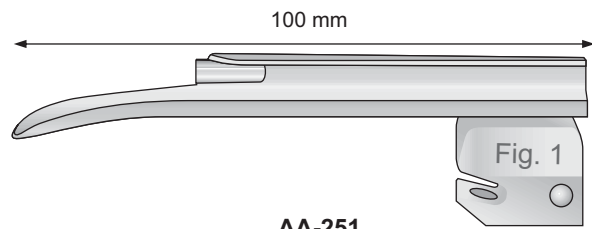

AA-251

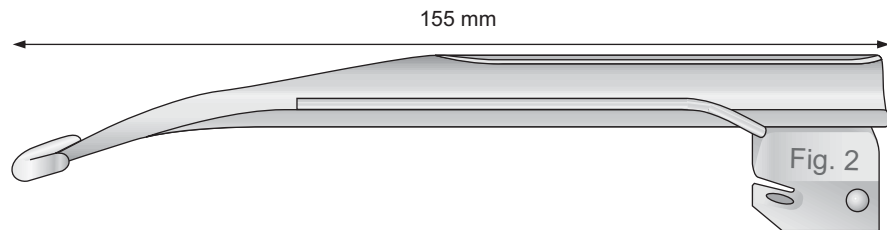

AA-252

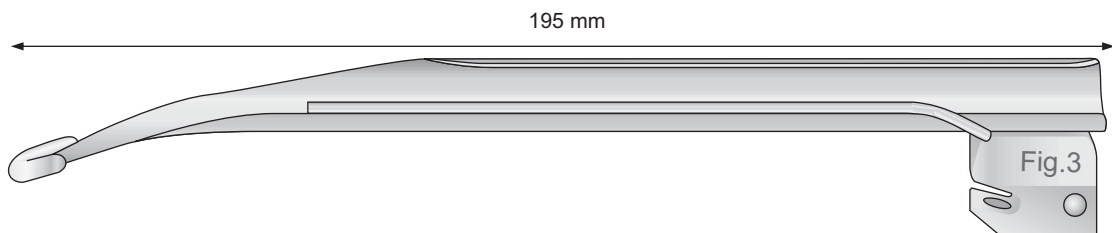

AA-253

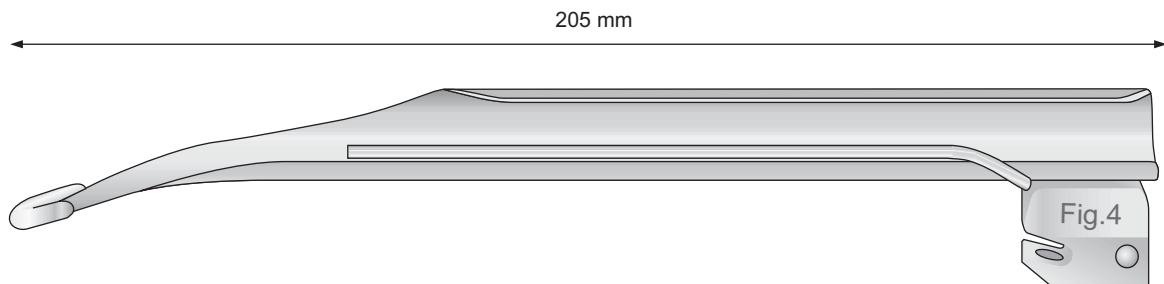

AA-254

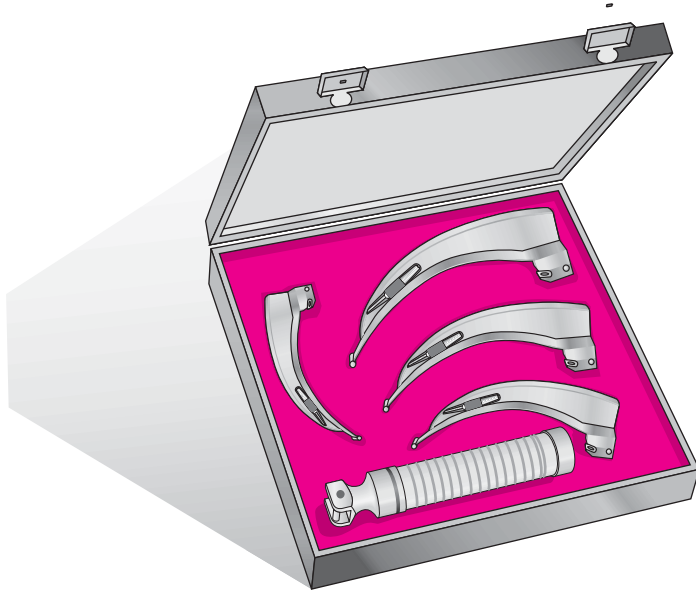

Mc INTOSH
AA-S103 - Set 3 lame
AA-S104 - Set 4 lame
AA-S105 - Set 5 lame

MILLER
AA-S203 - Set 3 lame
AA-S204 - Set 4 lame
AA-S205 - Set 5 lame

NEGUS-GUEDEL
AA-S403 - Set 3 lame
AA-S404 - Set 4 lame

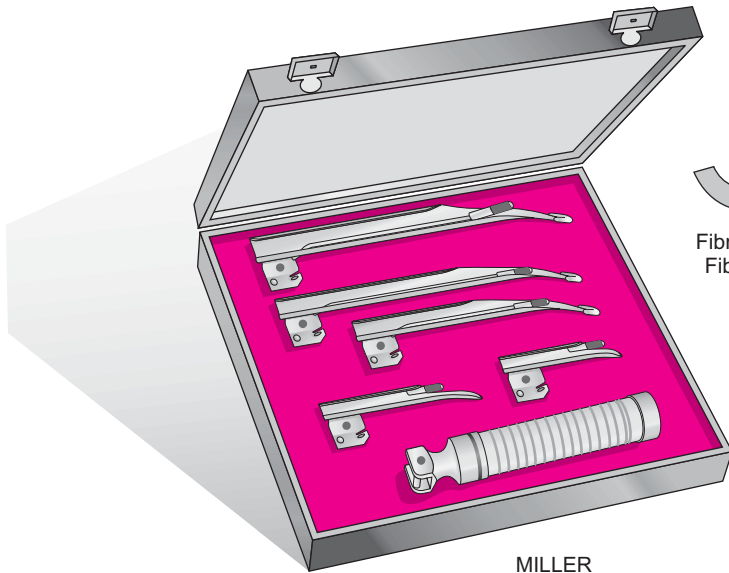

Fibre ottiche
Fiber optic

MILLER
AA-S255

MILLER
Fibre ottiche
AA-S253 - Set 3 lame
AA-S254 - Set 4 lame
AA-S255 - Set 5 lame

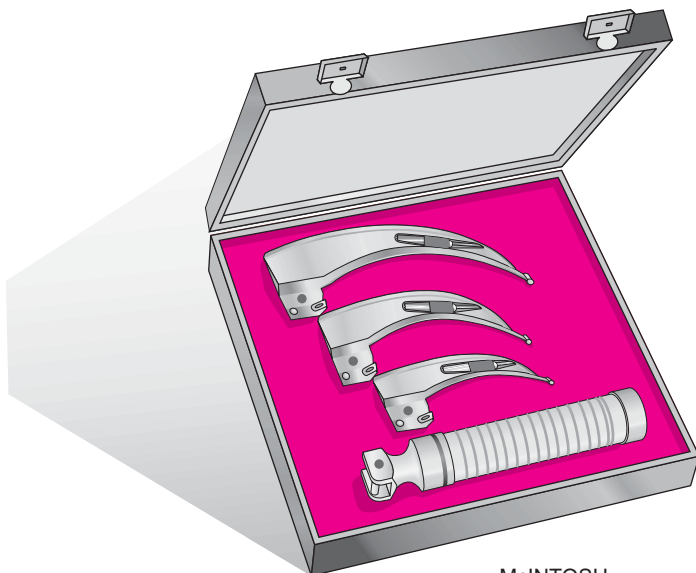

Fibre ottiche
Fiber optic

McINTOSH
AA-S503

Mc INTOSH
Fibre ottiche
AA-S503 - Set 3 lame
AA-S504 - Set 4 lame
AA-S505 - Set 5 lame

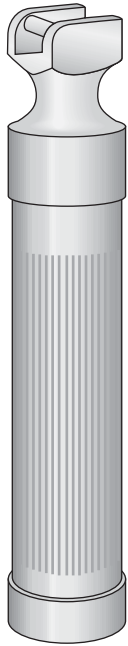

AA-T60
Ø 30 mm

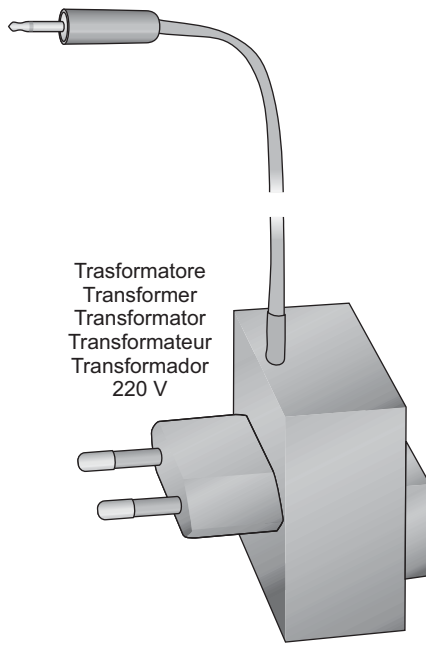

Trasformatore
Transformer
Transformator
Transformateur
Transformador
220 V

AA-151

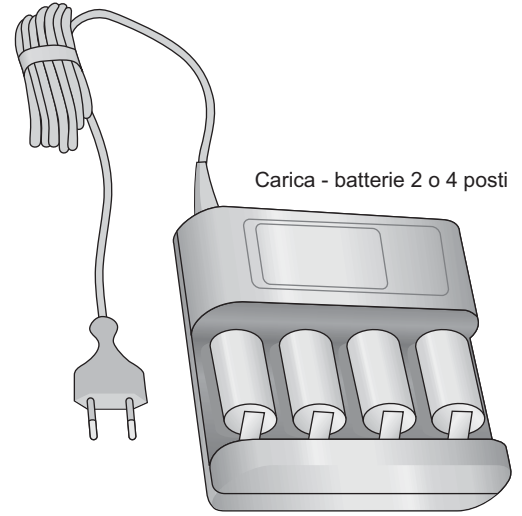

Carica - batterie 2 o 4 posti

AA-153



AA-130
640 mA



AA-B100
2,5 Volt
300 mA

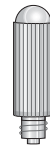

AA-B101
2,5 Volt
300 mA

Lampade alogene - Halogen lamp
Halogenlampe - Lampe halogène - Lámpara Houlógeno

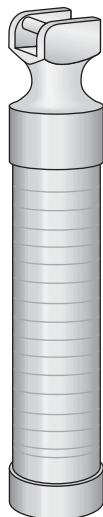

AA-70
Ø 30 mm

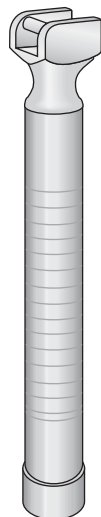

AA-80
Ø 18 mm

Fibre ottiche
Fiber optic

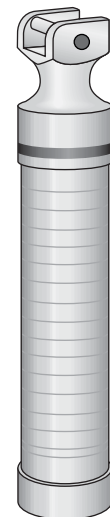

AA-90H
Ø 30 mm

01

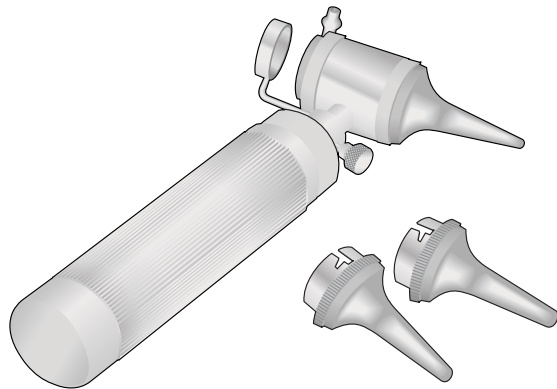

AB-32
Otoscopio completo di 3 speculum e scatola

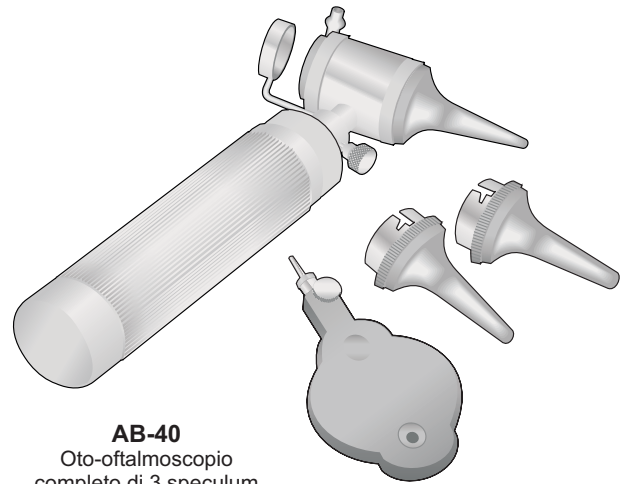

AB-40
Oto-oftalmoscopio completo di 3 speculum

Speculum in Nylon

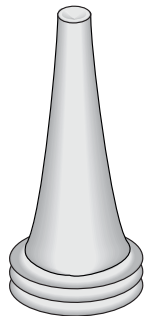

- # 1 - Ø 3,0 mm
- # 2 - Ø 4,5 mm
- # 3 - Ø 5,5 mm

AB-32R
Serie 3 pezzi

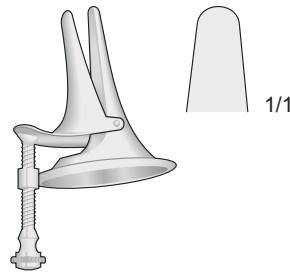

DUPLAY AB-41R



AB-38
Lampadina per otoscopio
Lamp
Lampe

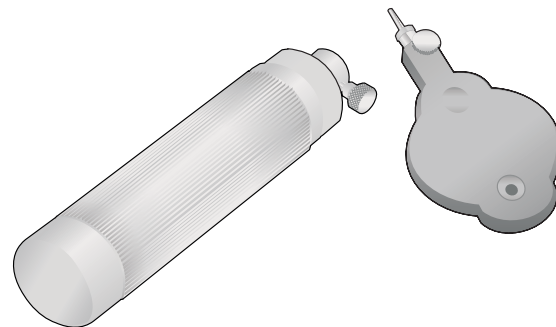

AB-34
Oftalmoscopio

Speculum per adulti

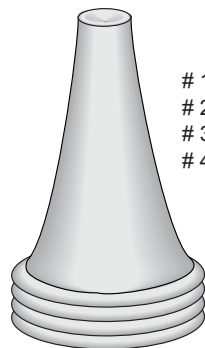

- # 1 - **AB-04** - Ø 4,5 mm
- # 2 - **AB-05** - Ø 5,5 mm
- # 3 - **AB-06** - Ø 6,5 mm
- # 4 - **AB-07** - Ø 7,5 mm

HARTMANN AB-09
Set 4 pezzi

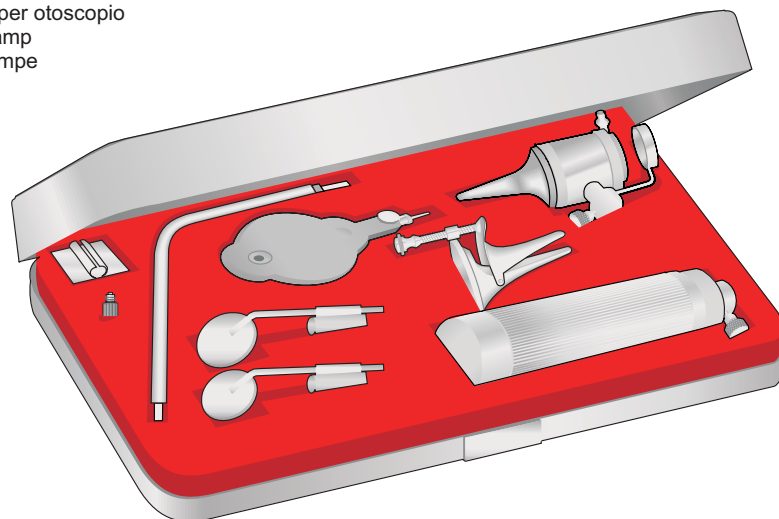

AB-41
Set oto-oftalmoscopio-speculum nasale e 2 specchietti laringei

Campo di misura: 0 - 15 mm
Measuring range: 0 - 15 mm
Meßbereich: 0 - 15 mm
Etendue de mesure: 0 - 15 mm
Alcance de medición: 0 - 15 mm

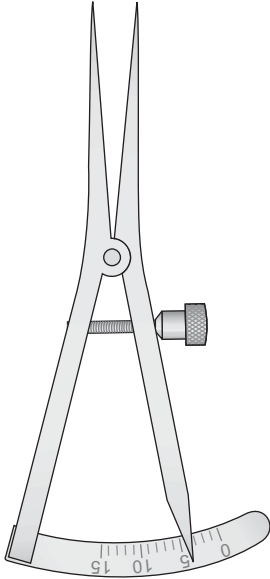

CASTROVIEJO
OR-15
90 mm

Campo di misura: 0 - 20 mm
Measuring range: 0 - 20 mm
Meßbereich: 0 - 20 mm
Etendue de mesure: 0 - 20 mm
Alcance de medición: 0 - 20 mm

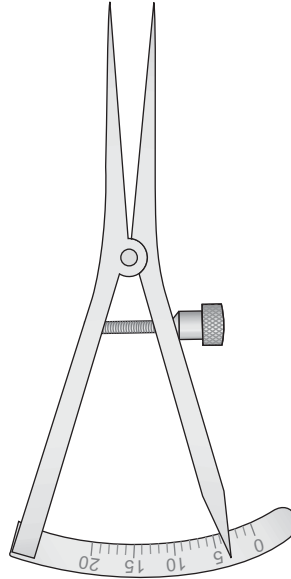

CASTROVIEJO
OR-17
90 mm

Campo di misura: 0 - 20 mm
Measuring range: 0 - 20 mm
Meßbereich: 0 - 20 mm
Etendue de mesure: 0 - 20 mm
Alcance de medición: 0 - 20 mm

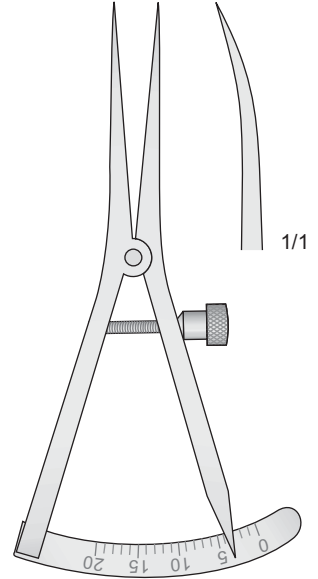

CASTROVIEJO
OR-19
90 mm

Campo di misura: 0 - 40 mm
Measuring range: 0 - 40 mm
Meßbereich: 0 - 40 mm
Etendue de mesure: 0 - 40 mm
Alcance de medición: 0 - 40 mm

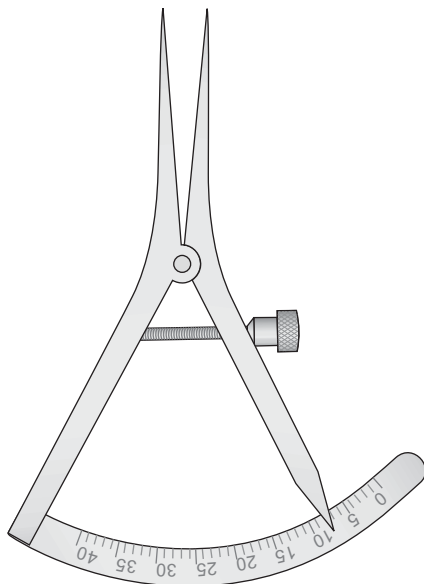

CASTROVIEJO
OR-11
90 mm

Campo di misura: 0 - 40 mm
Measuring range: 0 - 40 mm
Meßbereich: 0 - 40 mm
Etendue de mesure: 0 - 40 mm
Alcance de medición: 0 - 40 mm

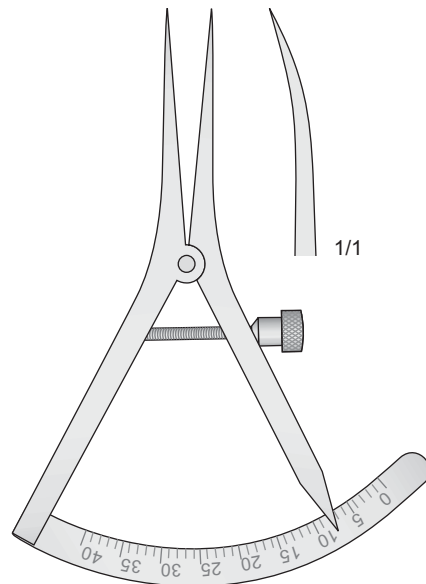

CASTROVIEJO
OR-13
90 mm

Campo di misura: 0 - 40 mm
 Measuring range: 0 - 40 mm
 Meßbereich: 0 - 40 mm
 Etendue de mesure: 0 - 40 mm
 Alcance de medición: 0 - 40 mm

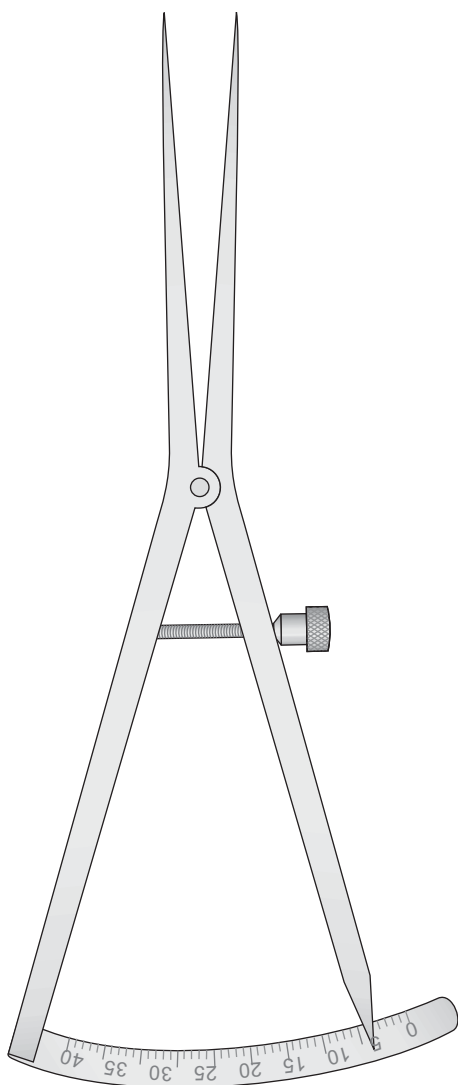

CASTROVIEJO
OR-12
 170 mm

Campo di misura: 0 - 40 mm
 Measuring range: 0 - 40 mm
 Meßbereich: 0 - 40 mm
 Etendue de mesure: 0 - 40 mm
 Alcance de medición: 0 - 40 mm

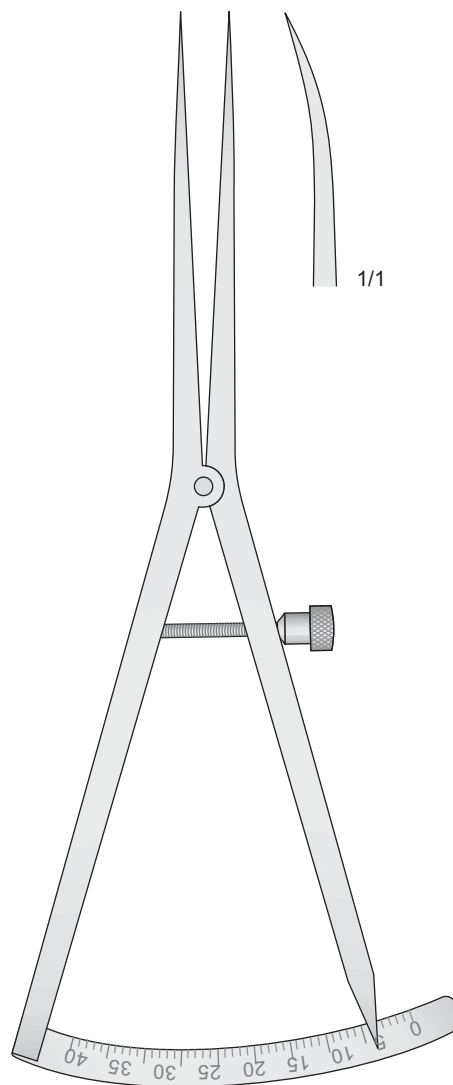

CASTROVIEJO
OR-14
 170 mm

Campo di misura: 0 - 40 mm
 Measuring range: 0 - 40 mm
 Meßbereich: 0 - 40 mm
 Etendue de mesure: 0 - 40 mm
 Alcance de medición: 0 - 40 mm

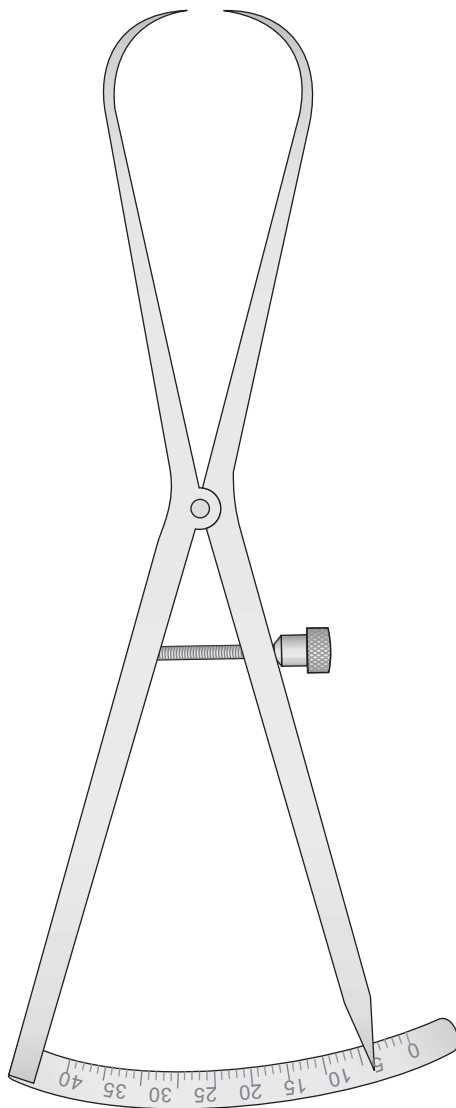

CASTROVIEJO
OR-16
 170 mm

Campo di misura: 0 - 40 mm
 Measuring range: 0 - 40 mm
 Meßbereich: 0 - 40 mm
 Etendue de mesure: 0 - 40 mm
 Alcance de medición: 0 - 40 mm

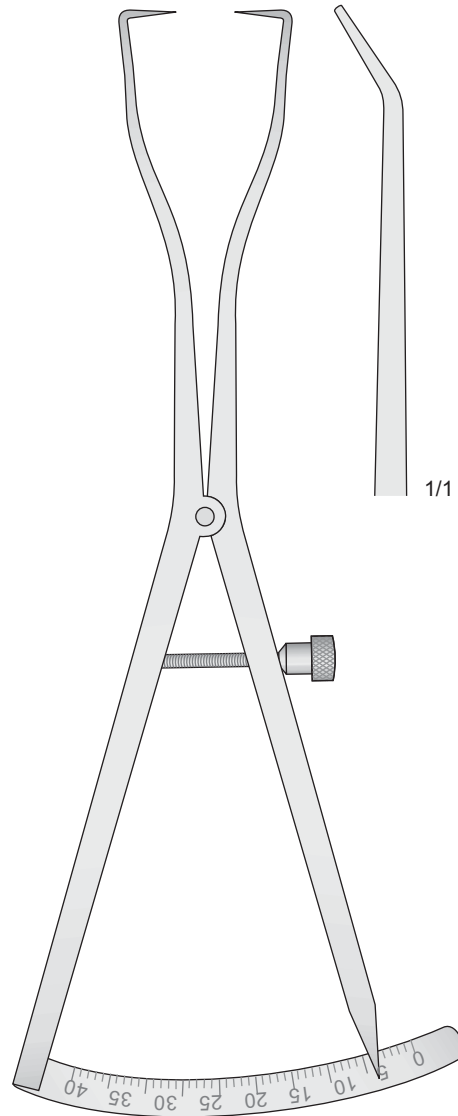

CASTROVIEJO
OR-18
 170 mm

01

Campo di misura: 0 - 80 mm
 Measuring range: 0 - 80 mm
 Meßbereich: 0 - 80 mm
 Etendue de mesure: 0 - 80 mm
 Alcance de medición: 0 - 80 mm

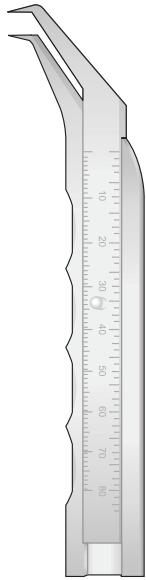

OR-40
125 mm

Campo di misura: 0 - 80 mm
 Measuring range: 0 - 80 mm
 Meßbereich: 0 - 80 mm
 Etendue de mesure: 0 - 80 mm
 Alcance de medición: 0 - 80 mm

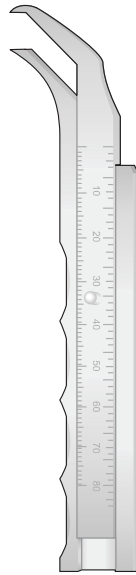

OR-42
120 mm

Campo di misura: 180 mm - Measuring range: 180 mm
 Meßbereich: 180 mm - Etendue de mesure: 180 mm - Alcance de medición: 180 mm

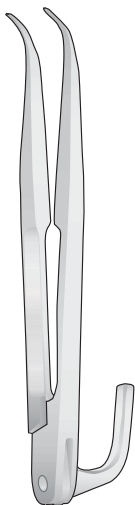

**ZIELINSKY
DP-725**
110 mm

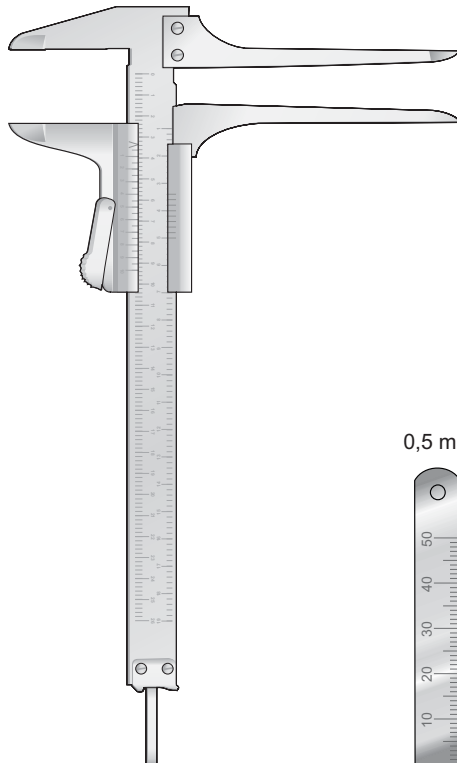

**CASPAR
OR-25**



LS-07
50 mm

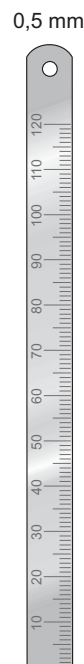

LS-08
120 mm



LS-09
150 mm



LS-06
300 mm

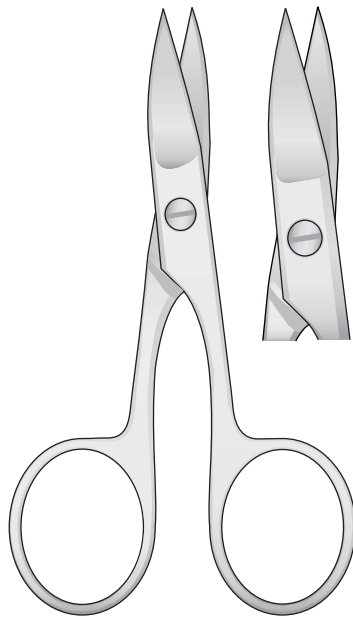

GS-23/GS-29

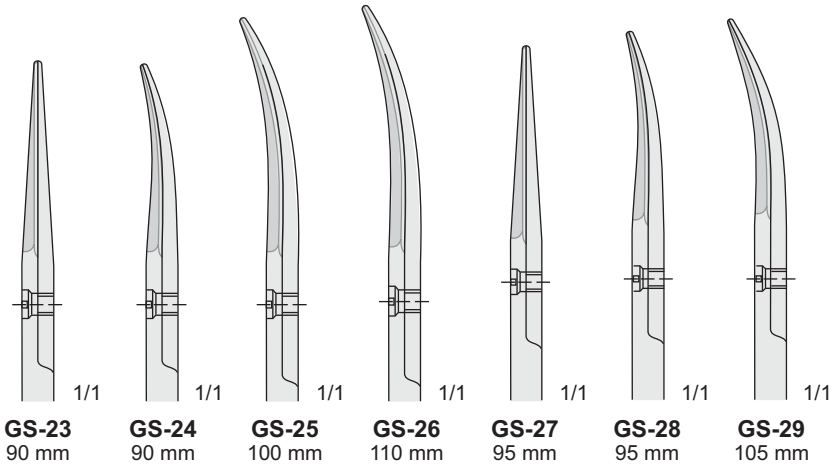

Tronchesi per unghie
Nail cutters
Nagelzangen
Pince à ongles
Pinzas para uña

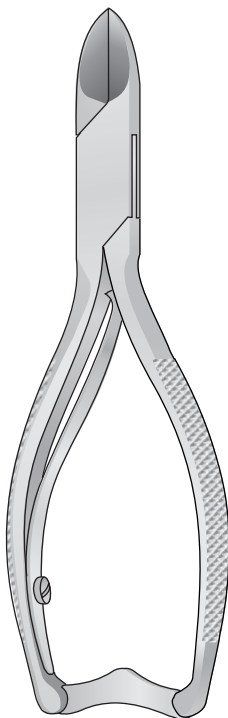

GS-20
135 mm

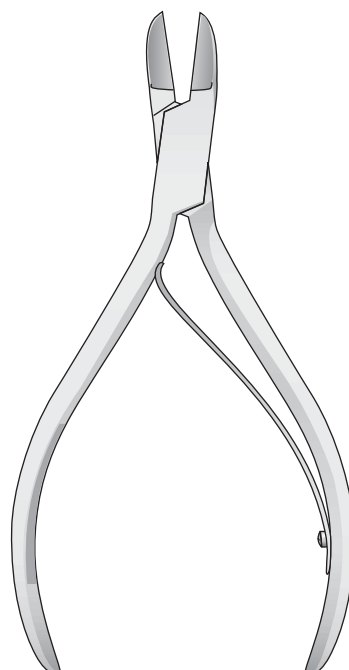

GS-21
120 mm

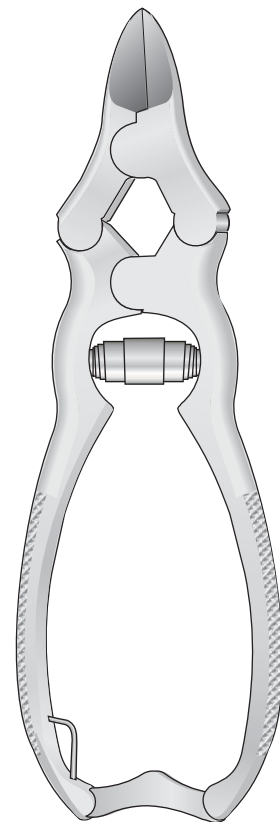

GS-22
155 mm

01

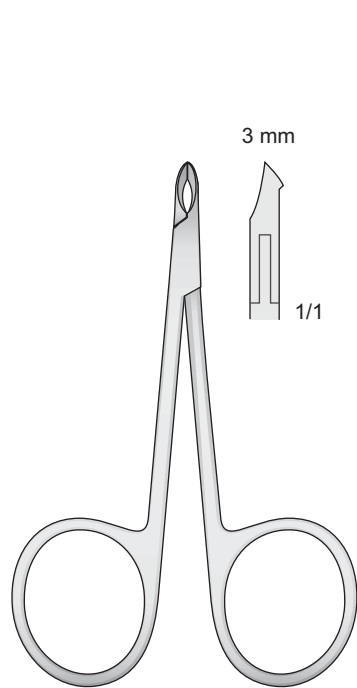

GS-40
85 mm

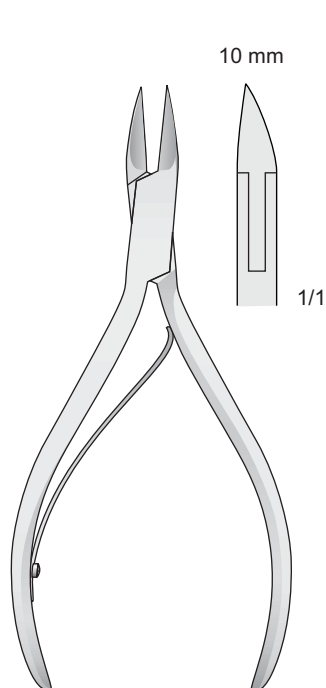

GS-42
100 mm

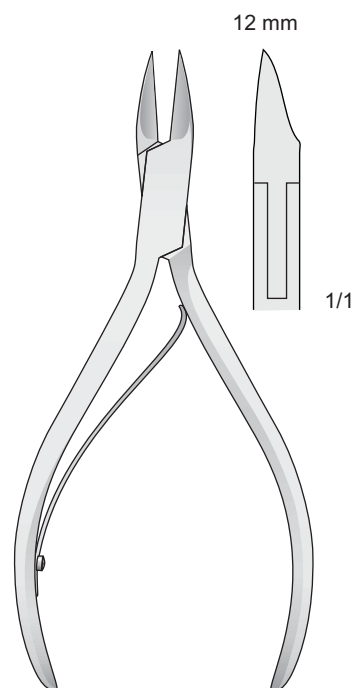

GS-44
110 mm

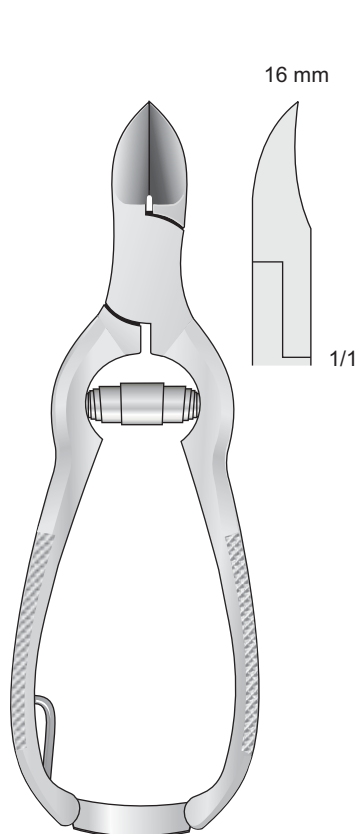

GS-46
120 mm

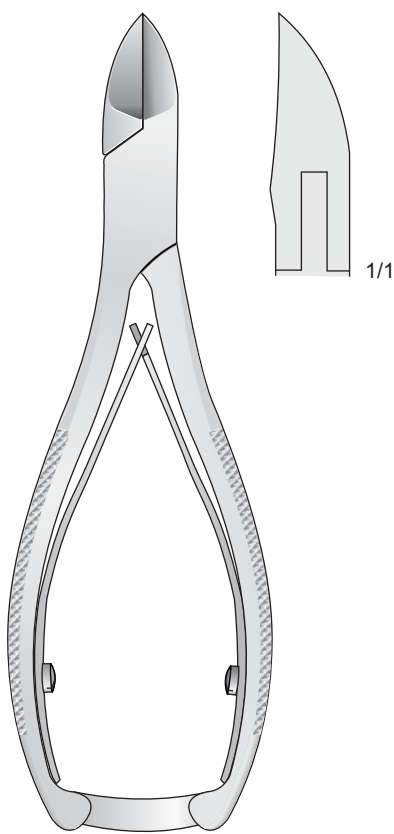

GS-48
140 mm

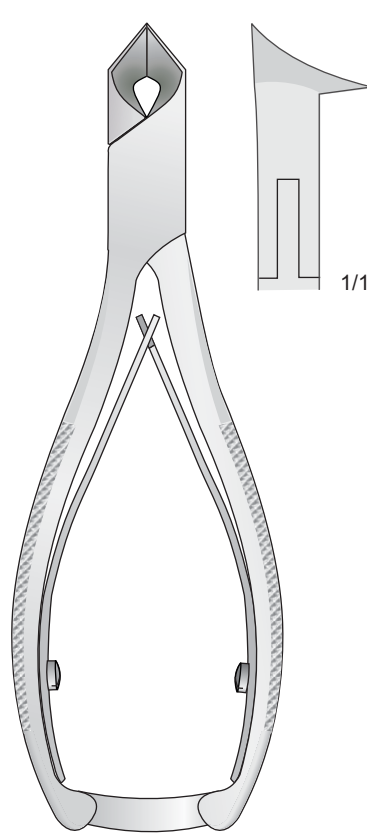

GS-50
135 mm

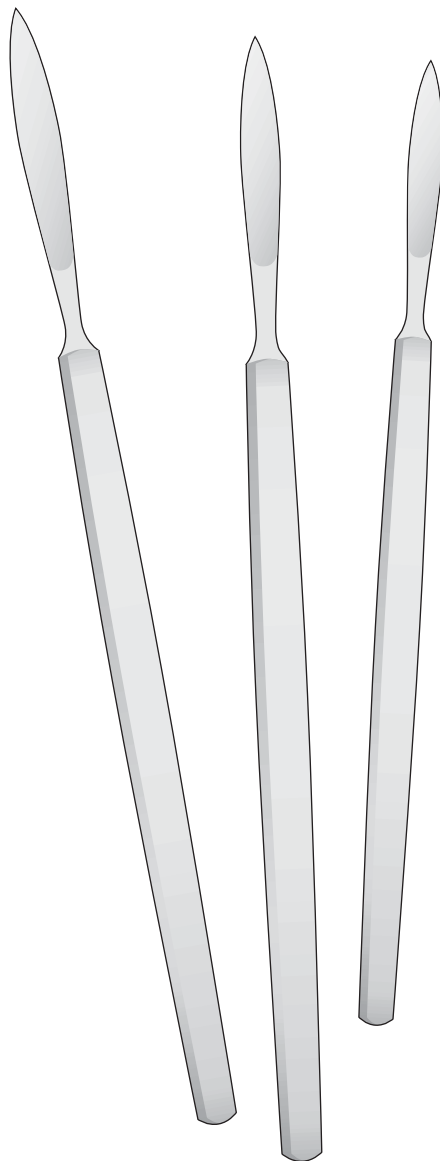

02

Scalpel Blades and Handles
Skalpellklingen und Skalpellgriffe
Lames et manches de bistouris
Hojas y mangos de bisturí
Lame e manici per bisturi

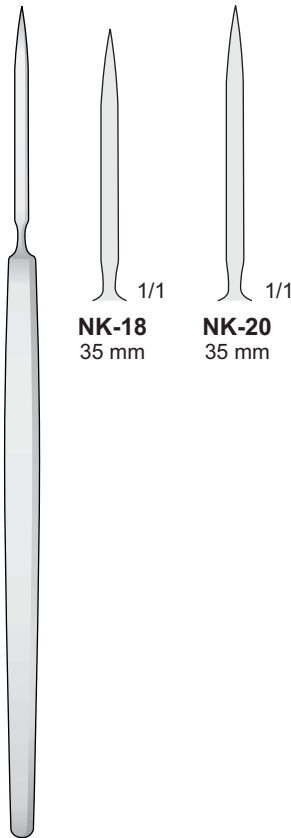

NK-18
35 mm

NK-20
35 mm

GRAEFE
NK-18/NK-20
140 mm

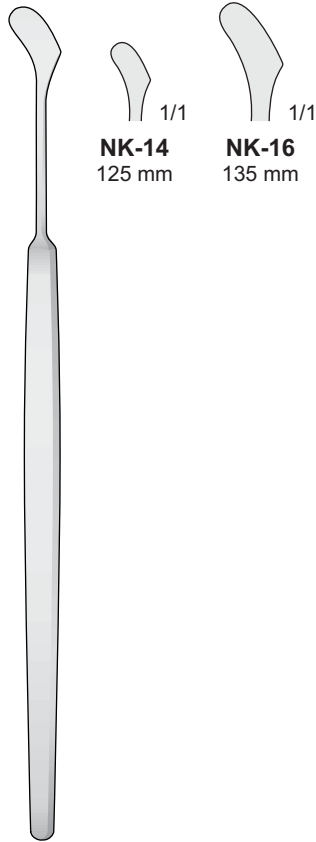

NK-14
125 mm

NK-16
135 mm

GRAEFE
NK-14/NK-16

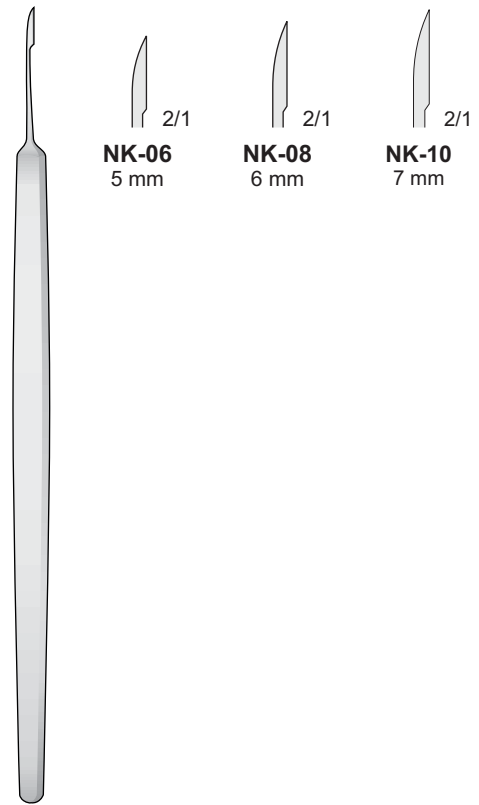

NK-06
5 mm

NK-08
6 mm

NK-10
7 mm

ZIEGLER
NK-06/NK-10
115 mm

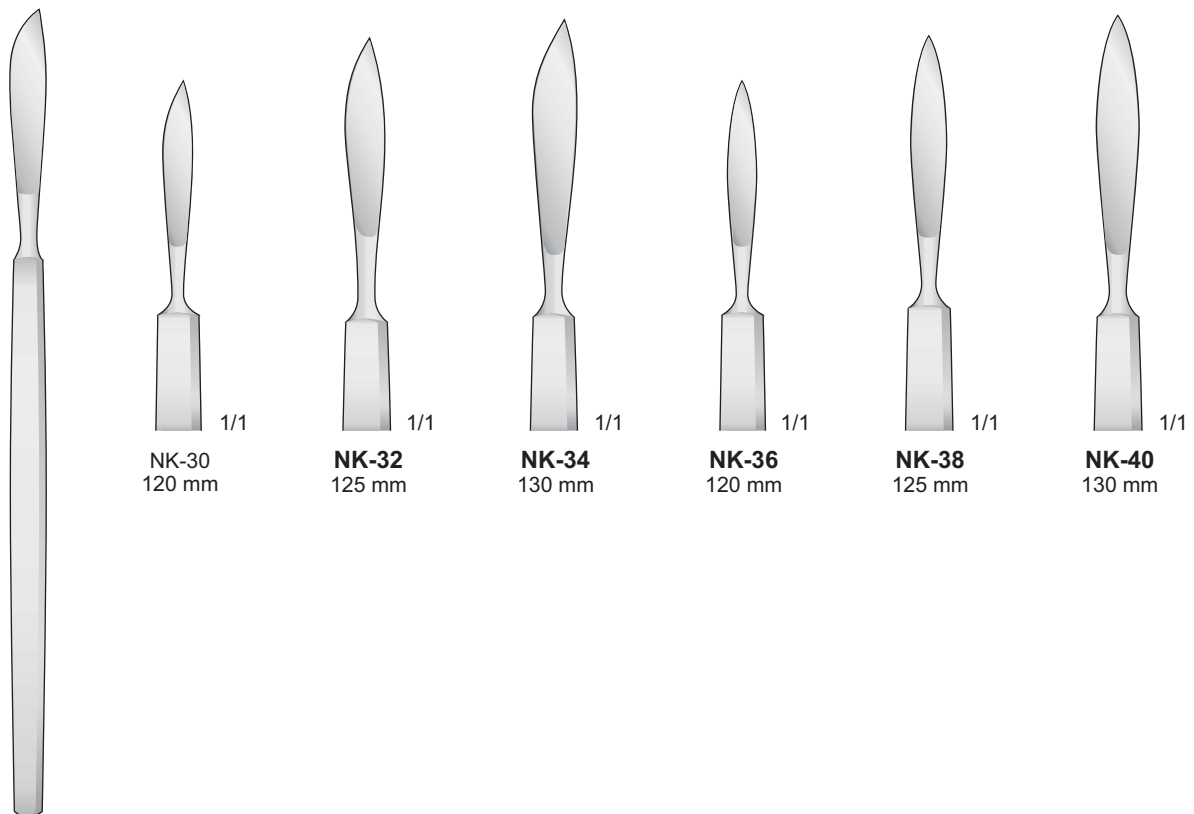

NK-30
120 mm

NK-32
125 mm

NK-34
130 mm

NK-36
120 mm

NK-38
125 mm

NK-40
130 mm

NK-30/NK-40

Punche da biopsia - Dermal punches
Haut-Trephinen - Tréphines cutanées
Trépanos cutâneos

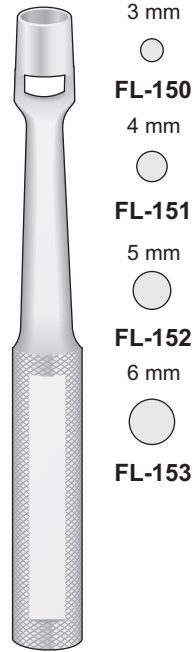

KEYES
FL-150/FL-153
100 mm



DESMARES
NK-95
135 mm



DESMARES
NK-96
135 mm

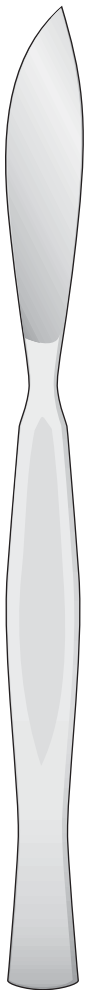

NK-90
180 mm



NK-91
280 mm

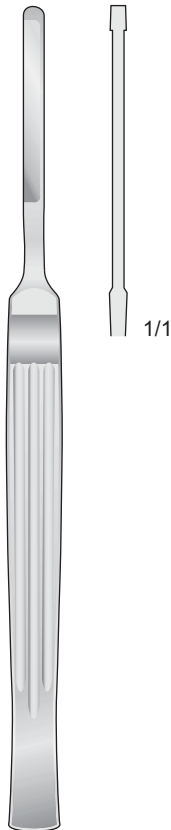

JOSEPH
NK-100
150 mm

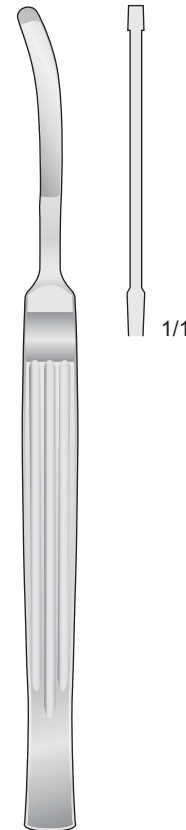

CONVERSE
NK-101
160 mm



NK-102
160 mm



1/1

NK-31/NK-57



1/1

NK-50
150 mm



1/1

NK-51
155 mm



1/1

NK-31
158 mm



1/1

NK-52
160 mm



1/1

NK-53
170 mm



1/1

NK-35
175 mm



1/1

NK-54
150 mm



1/1

NK-55
155 mm



1/1

NK-33
158 mm



1/1

NK-56
160 mm



1/1

NK-57
170 mm



1/1

NK-37
175 mm

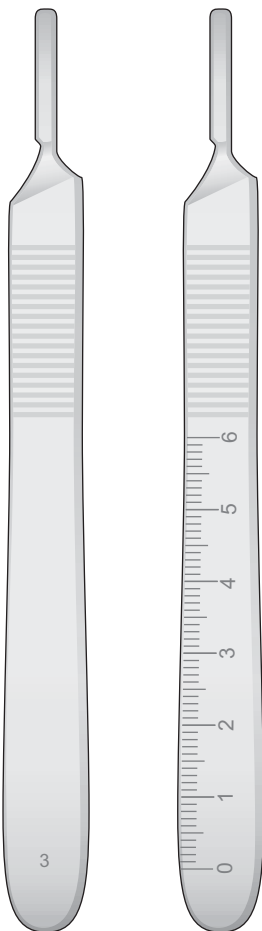
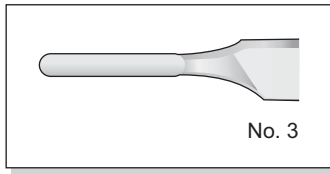

MA-B3
Fig. 3



MA-B7
Fig. 7



MA-B7K
Fig. 7k



MA-B1
Fig. 5



MA-B2
Fig. 5a

1,5 mm



MA-B8

2,5 mm



MA-B9



MA-B8/MA-B9
155 mm

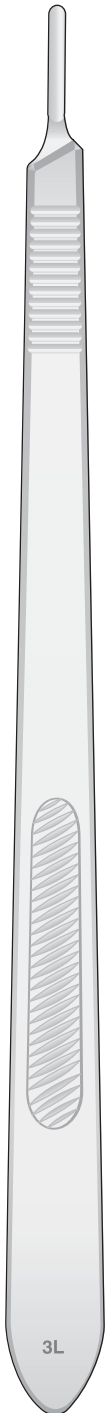
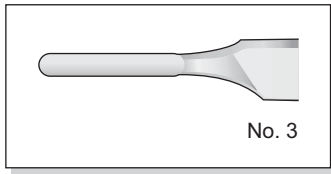

MA-B3L
Fig. 3L

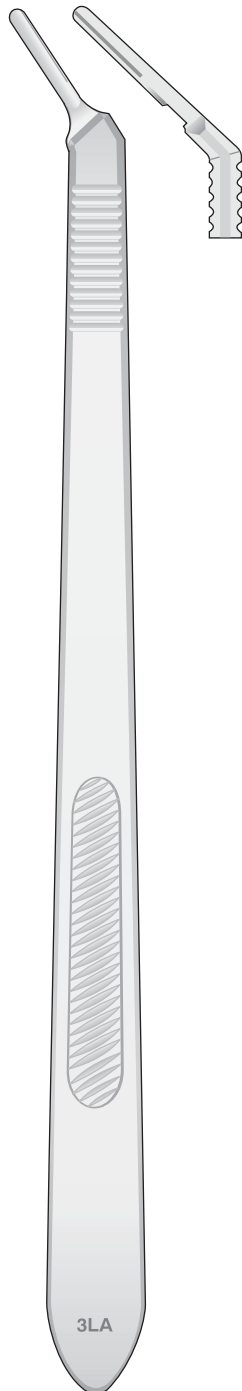

MA-B5
Fig. 3LA



MA-B11
210 mm

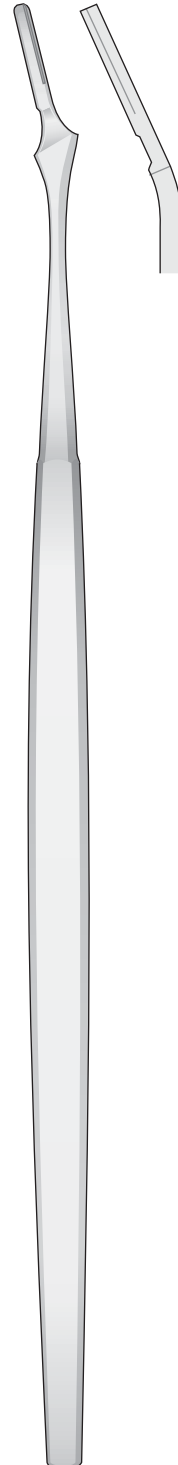

MA-B12
210 mm

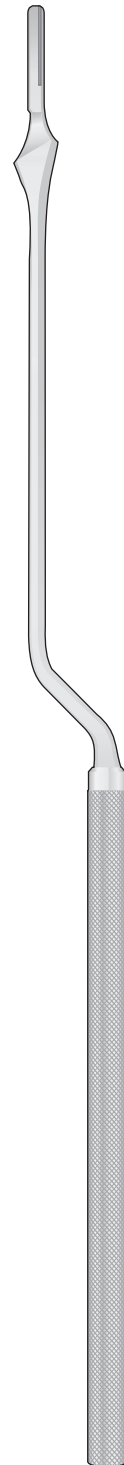

MA-B15
210 mm

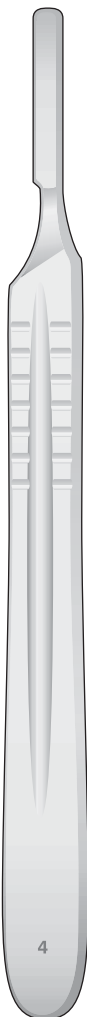
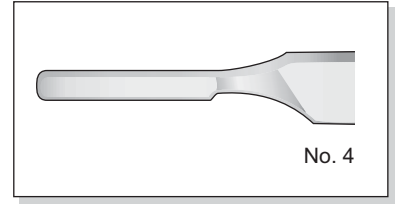

MA-B4
Fig. 4

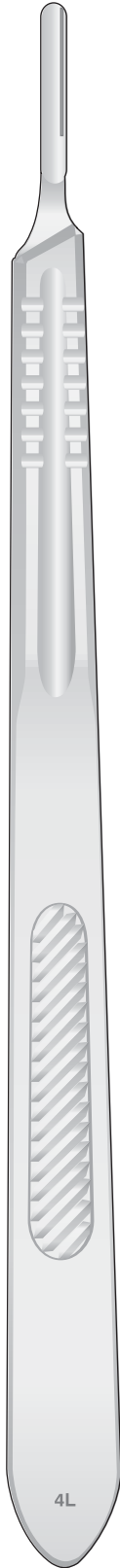

MA-B4L
Fig. 4L

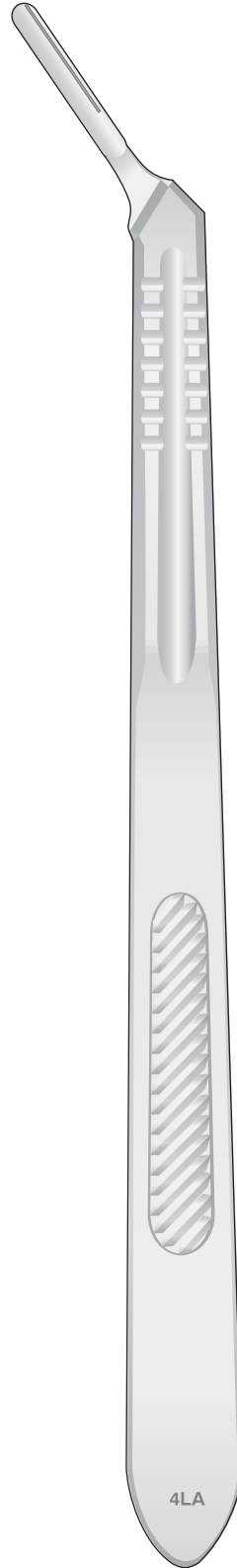

MA-B6
Fig. 4LA

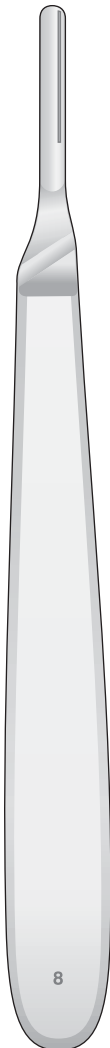

MA-B10
Fig. 8

Scatole da 100 pezzi
Packungen à 100
Packages of 100 ea
Boîtes de 100 pièces
Cajas de 100 c/u

Doppio taglio
Double cutting
Doppelschneidig
Deux tranchants
Doble corta

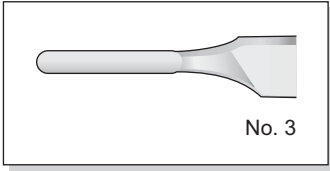

LB-10
Fig. 10



LB-11
Fig. 11

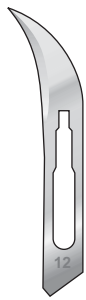

LB-12
Fig. 12

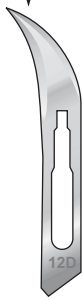

LB-12D
Fig. 12D



LB-13
Fig. 13



LB-15
Fig. 15

Scalpel blades, steril

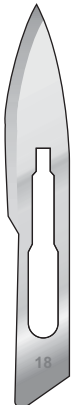
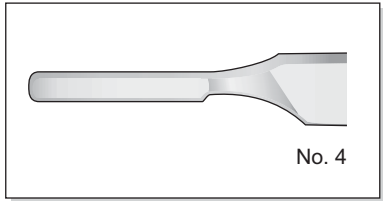

LB-18
Fig. 18

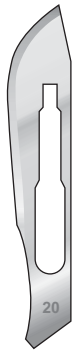

LB-20
Fig. 20



LB-21
Fig. 21



LB-22
Fig. 22



LB-23
Fig. 23



LB-24
Fig. 24



LB-25
Fig. 25



LB-36
Fig. 36



LB-361
Conf. 10 pz.



LB-362
Conf. 10 pz.



LB-363
Conf. 1 pz.



LB-364
Conf. 10 pz.



LB-365
Conf. 10 pz.

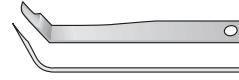

LB-366
Conf. 1 pz.



LB-367
Conf. 10 pz.



LB-368
Conf. 10 pz.



LB-369
Conf. 1 pz.



NK-1
100 mm



NK-2
150 mm



BB-46
135 mm



BB-48 - 155 mm
BB-50 - 180 mm
BB-52 - 200 mm



CASPAR
BB-50



BB-52

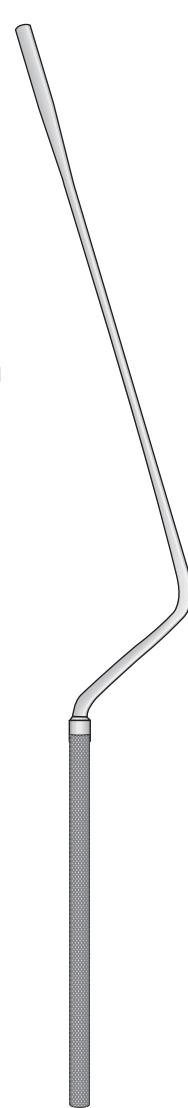

LANDOLT
BB-38
210 mm

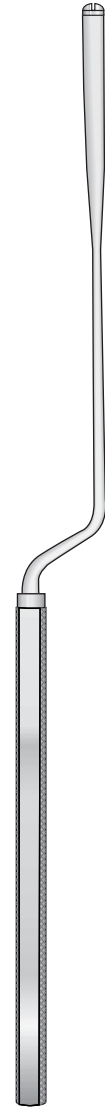

LANDOLT
BB-40
250 mm

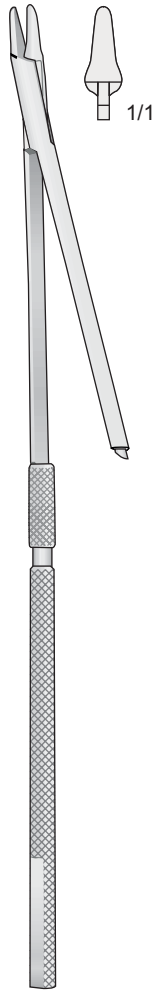

NK-85
180 mm

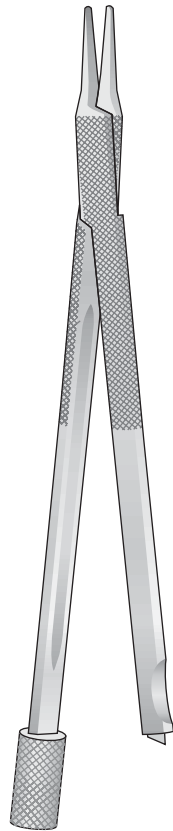

NK-12
120 mm

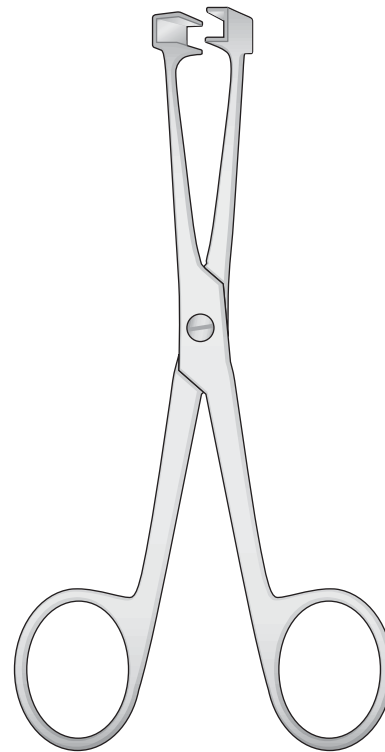
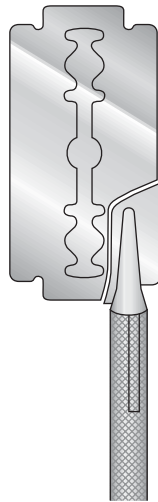

GS-18
135 mm

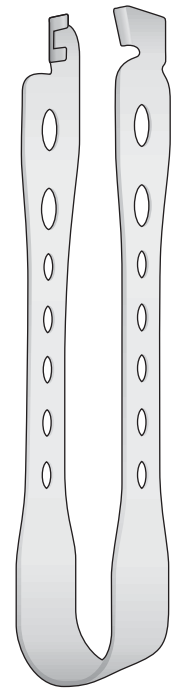

GS-16
115 mm



03

Scissors
Scheren
Ciseaux
Tijeras
Forbici

03

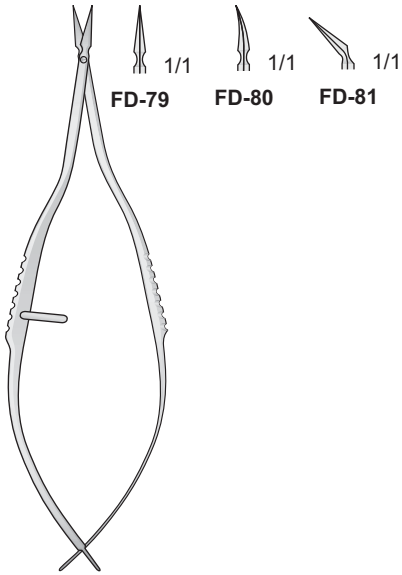

VANNAS
FD-79/FD-81
85 mm

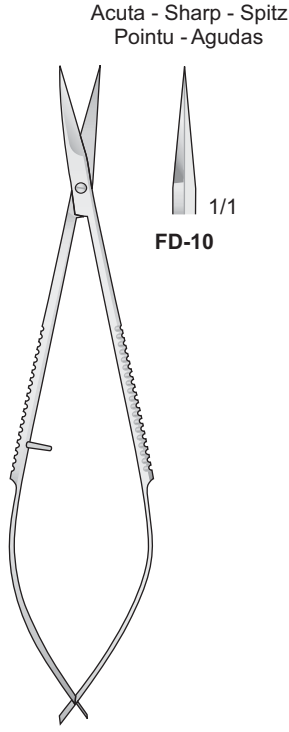

NOYES
FD-10
120 mm

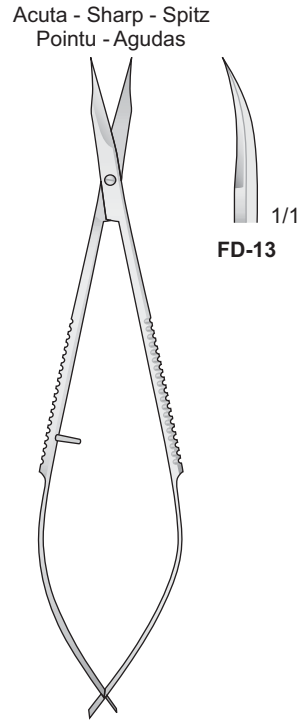

WESTCOTT
FD-13
120 mm

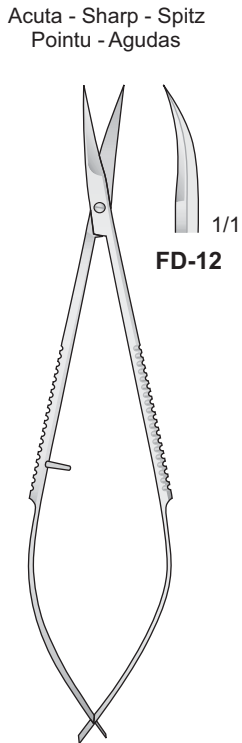

NOYES
FD-12
120 mm

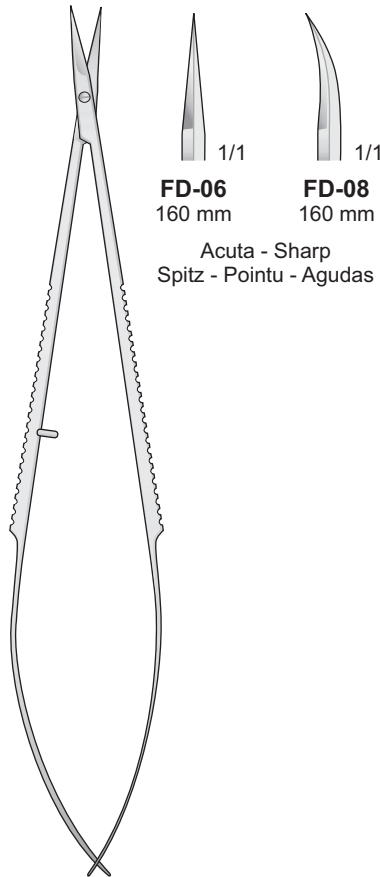

FD-06/FD-08
160 mm

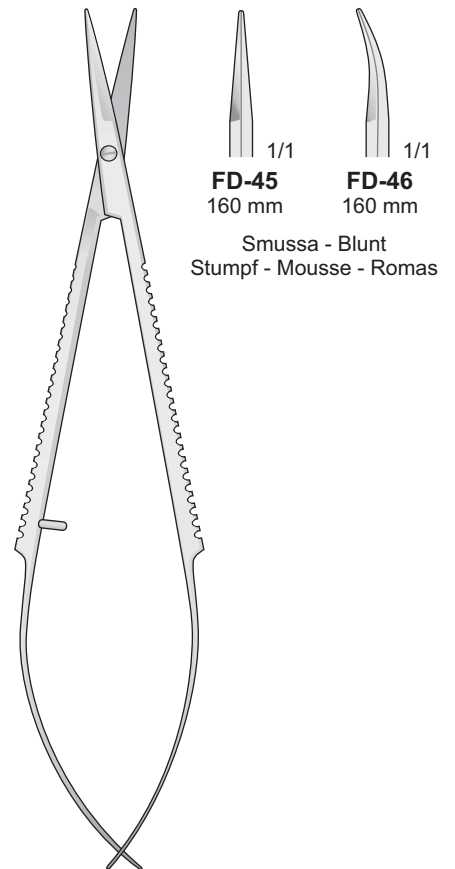

FD-45/FD-46
160 mm



YASARGIL
FD-186
185 mm

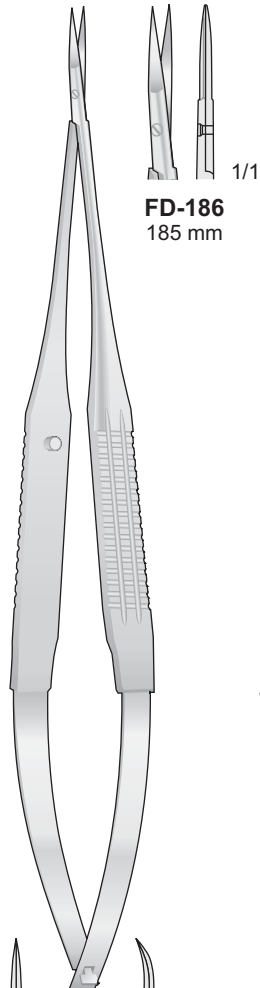

FD-186
185 mm

1/1

JACOBSON
FD-187
185 mm

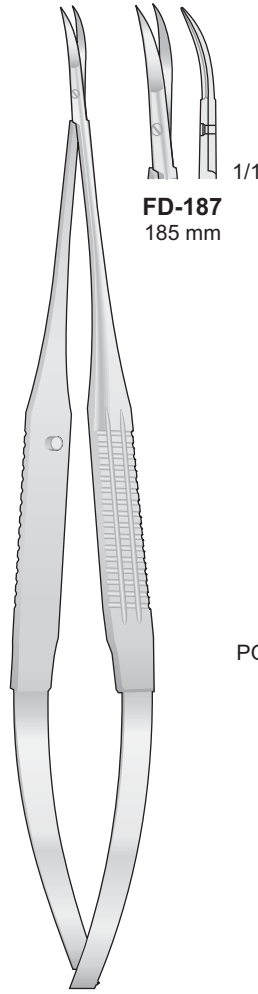

FD-187
185 mm

1/1

POTTS-YASARGIL
FD-191
185 mm

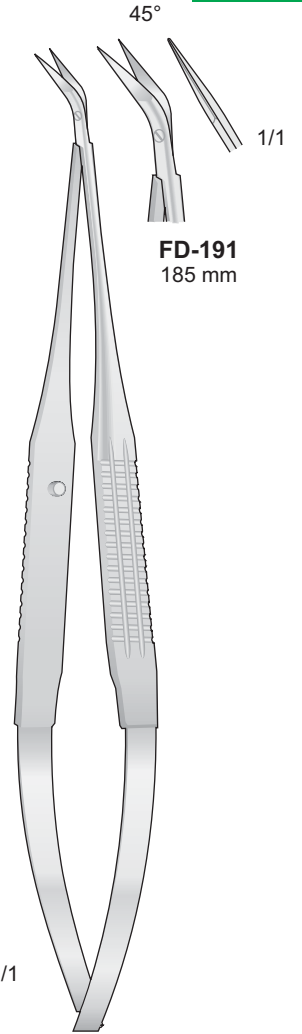

FD-191
185 mm

45°

1/1

FD-137
150 mm

FD-138
150 mm

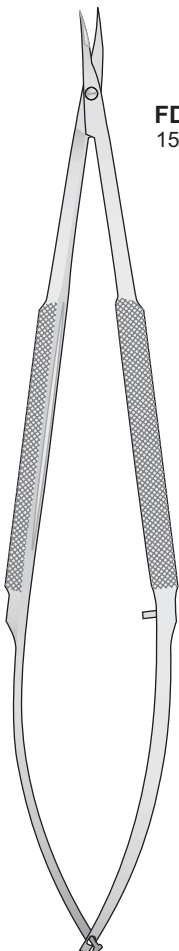

FD-137/FD-138
150 mm

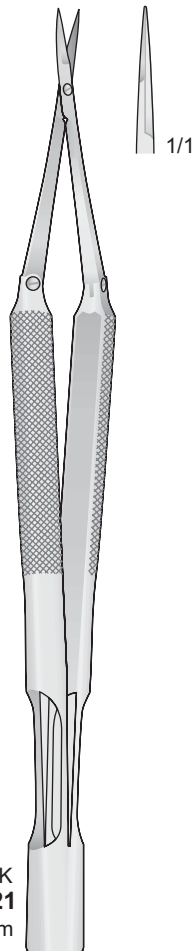

BROCK
FD-221
150 mm

1/1

BROCK
FD-223
150 mm

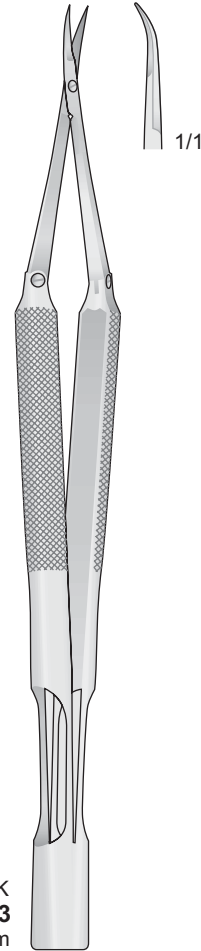

1/1

Acute
Pointed
Spitz
Pointus
Agudas

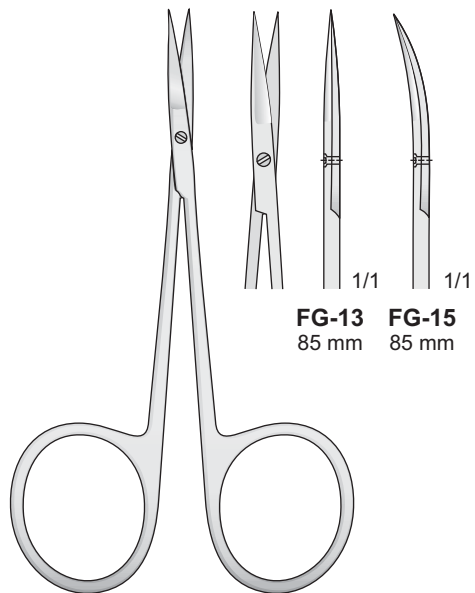

MICRO-IRIS
FG-13/FG-15
85 mm

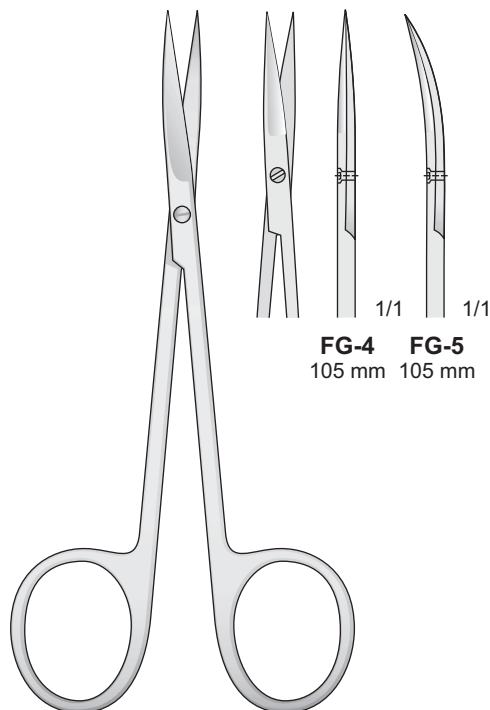

FG-4/FG-5
105 mm

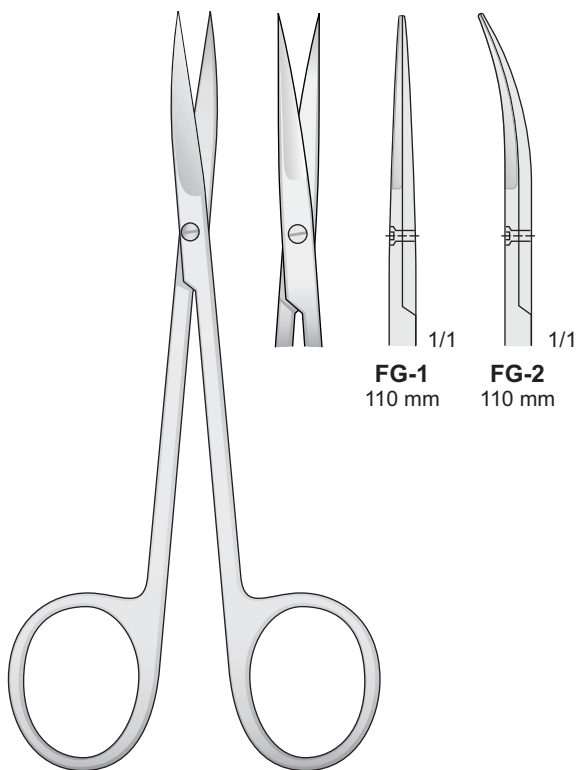

IRIS
FG-1/FG-2
110 mm

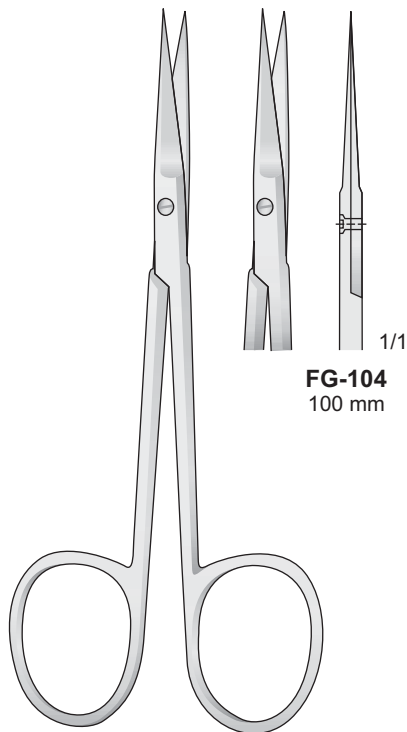

FG-104
100 mm

Smussa - Blunt
Stumpf - Émoussé - Romo

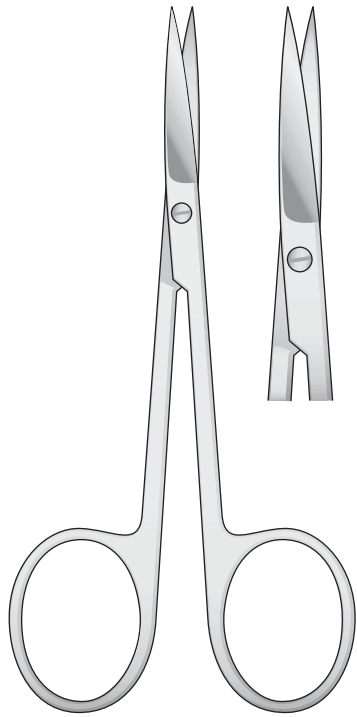

1/1 1/1
FG-23 **FG-24**

FG-23/FG-24
110 mm

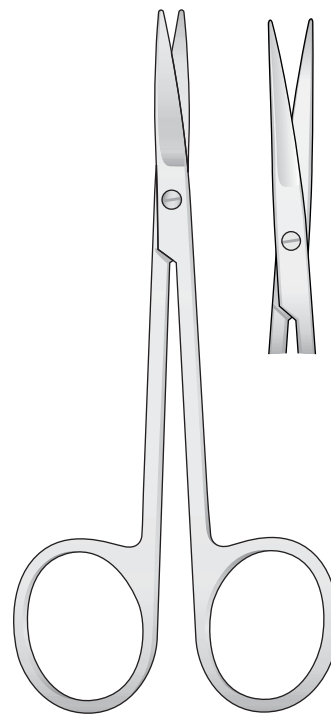

1/1 1/1
FG-101 **FG-102**
110 mm 110 mm

FG-101/FG-102
110 mm

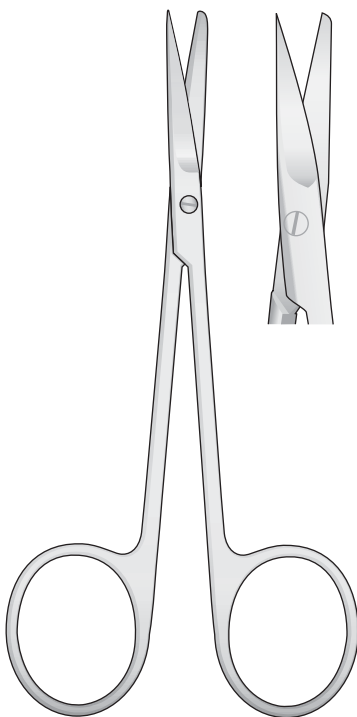

1/1 1/1
FG-103 **FG-105**

FG-103/FG-105
110 mm

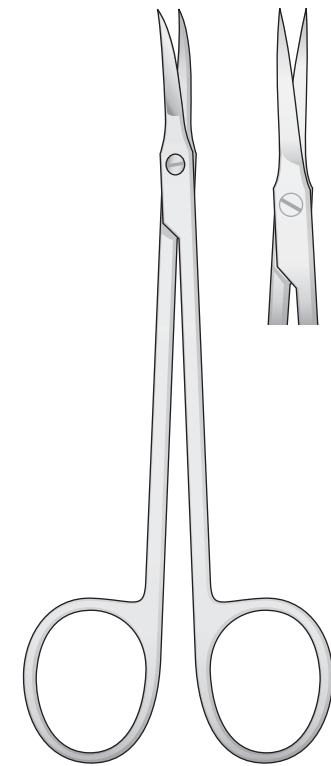

1/1 1/1
GFR-S **GFC-S**

GFR-S/GFC-S
120 mm

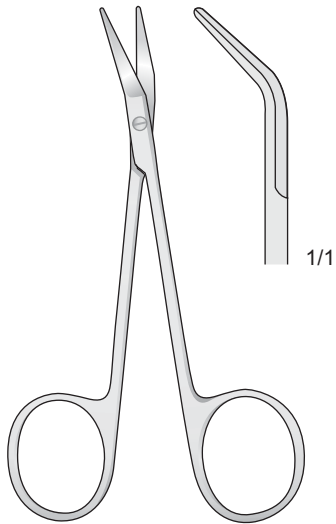

GRAEFE
FG-30
100 mm

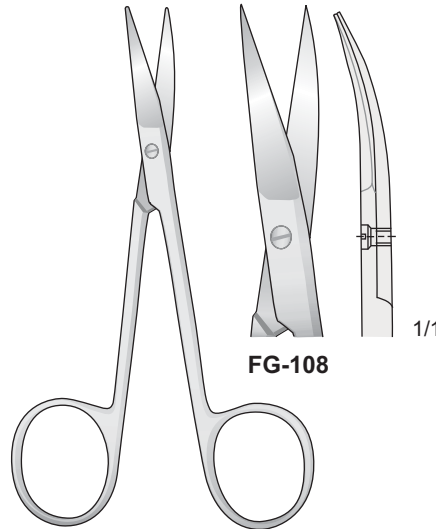

COTTLE-MASING
FG-108/FG-109
105 mm

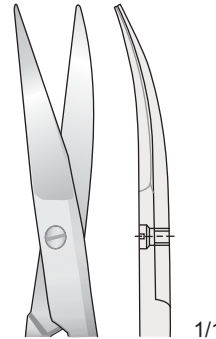

FG-109

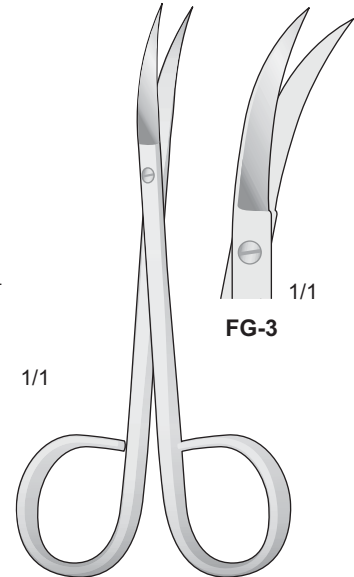

FG-3
115 mm

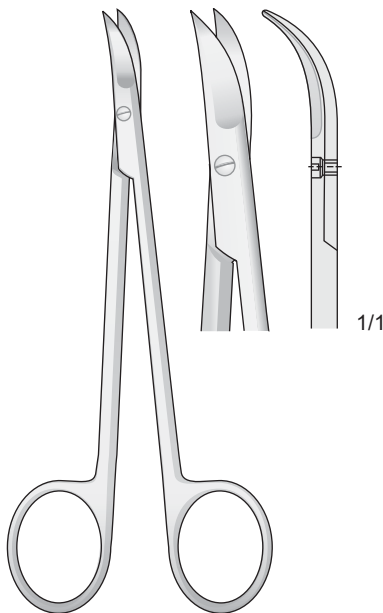

CHADWICK
FG-39
115 mm

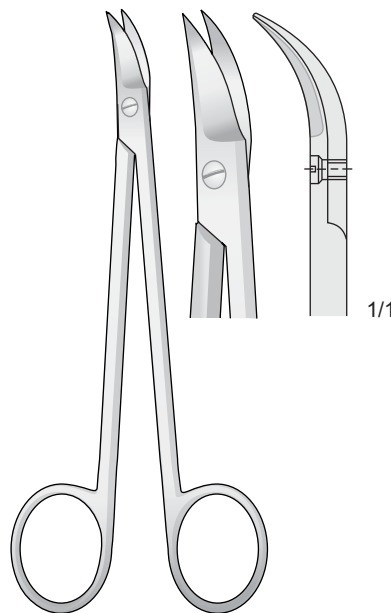

QUINBY
FG-38
130 mm

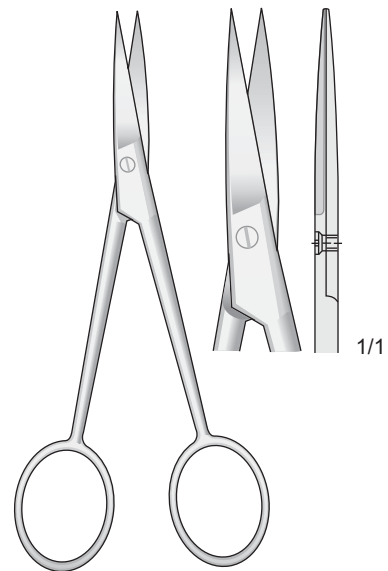

FG-119
110 mm

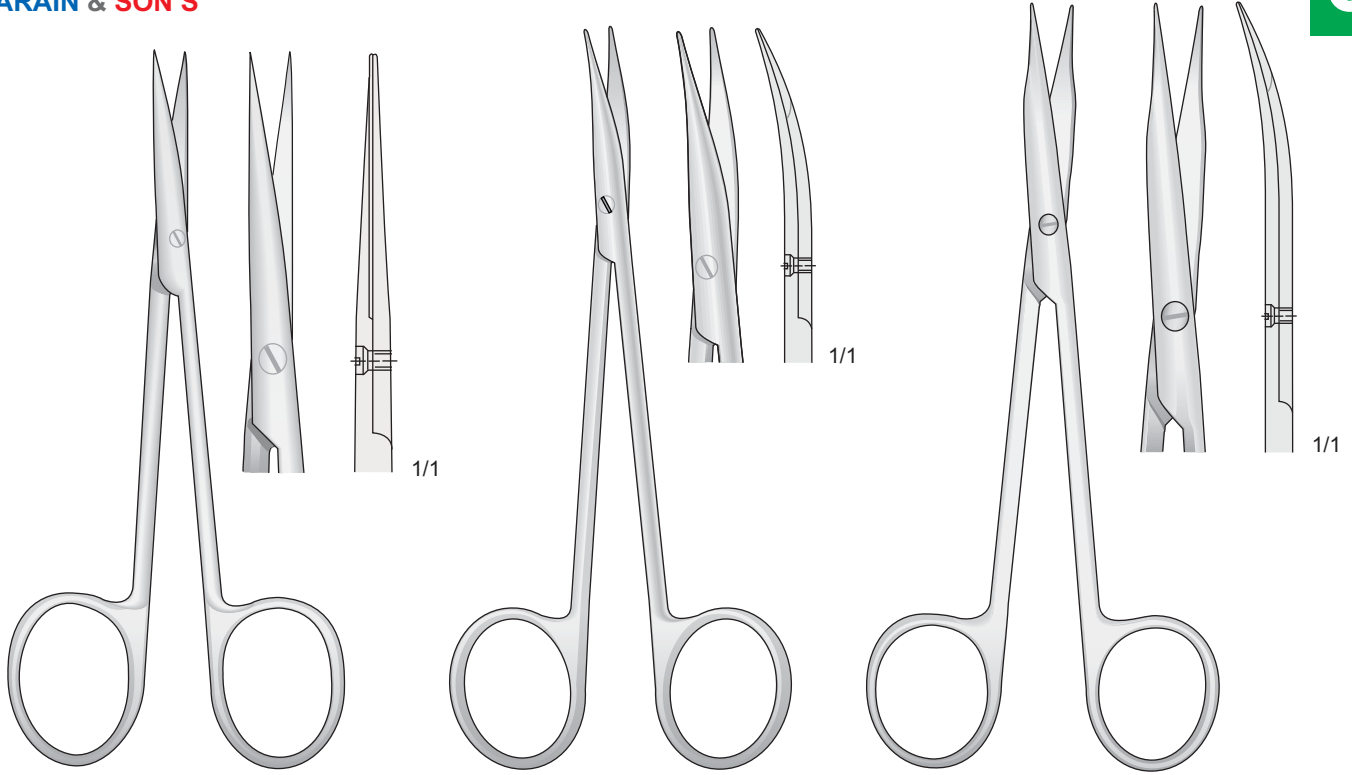

KILNER
FG-58
115 mm

JAMESON-WERBER
FG-123
130 mm

JAMESON
FG-124
145 mm

Smussa - Blunt
Stumpf - Émoussé - Romo

Acuta - Sharp
Spitz - Aigu - Agudo

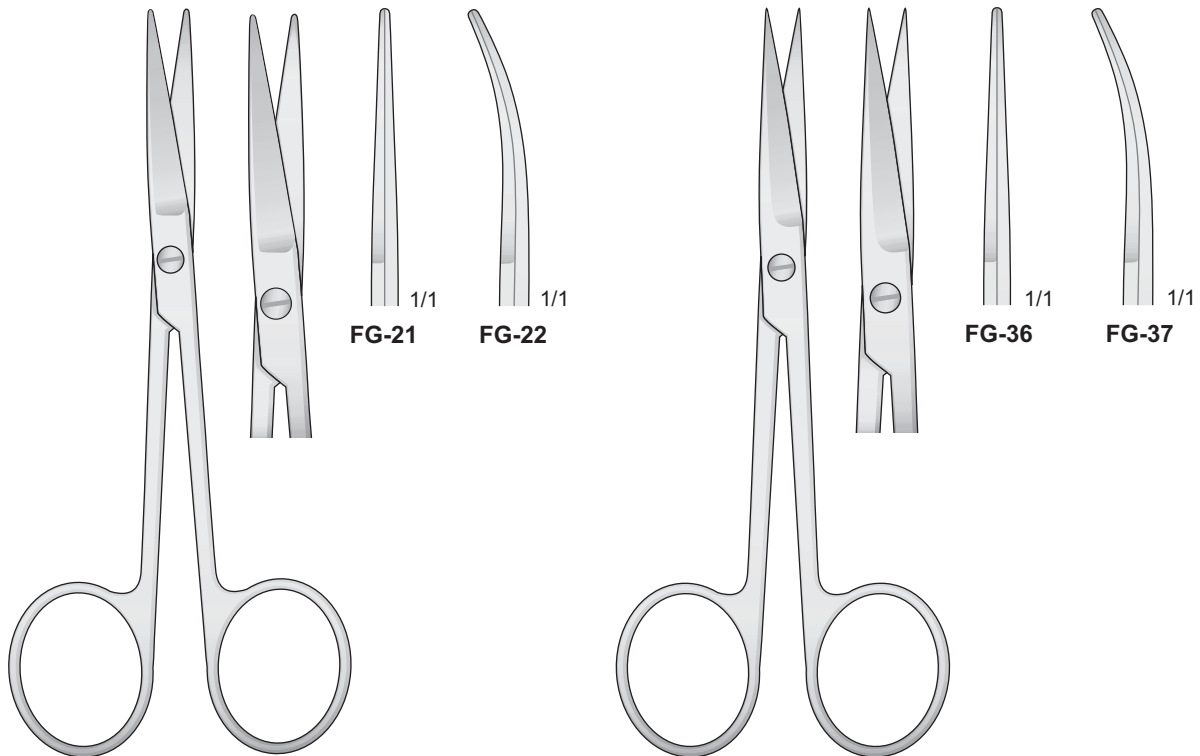

G-21/FG-22
115 mm

FG-36/FG-37
115 mm

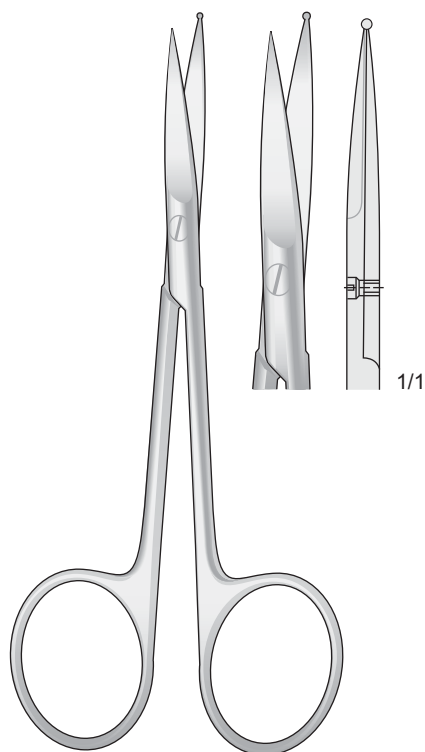

FG-131
120 mm

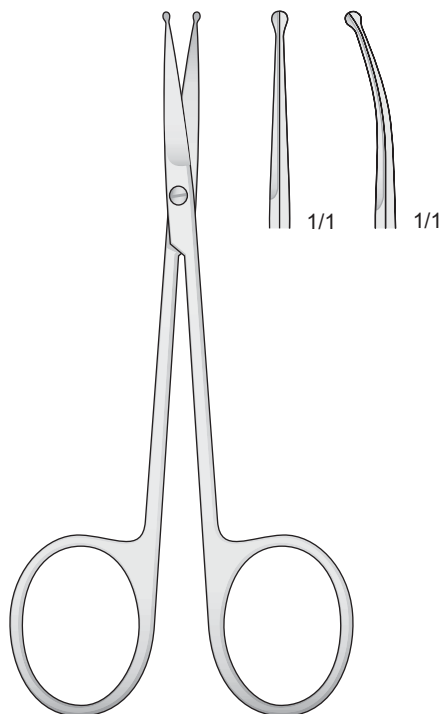

FG-25/FG-26
110 mm



LOCKLIN MOD.
LK-3
110 mm

Dentellata - Sawedge - Gezahnt - Dentelé - Dentadas

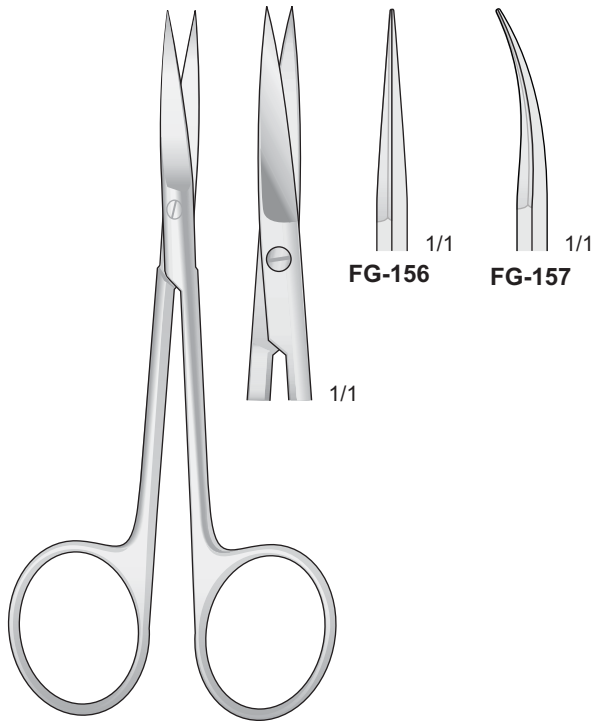

FG-156/FG-157
110 mm

Dentellata - Sawedge - Gezahnt - Dentelé - Dentadas

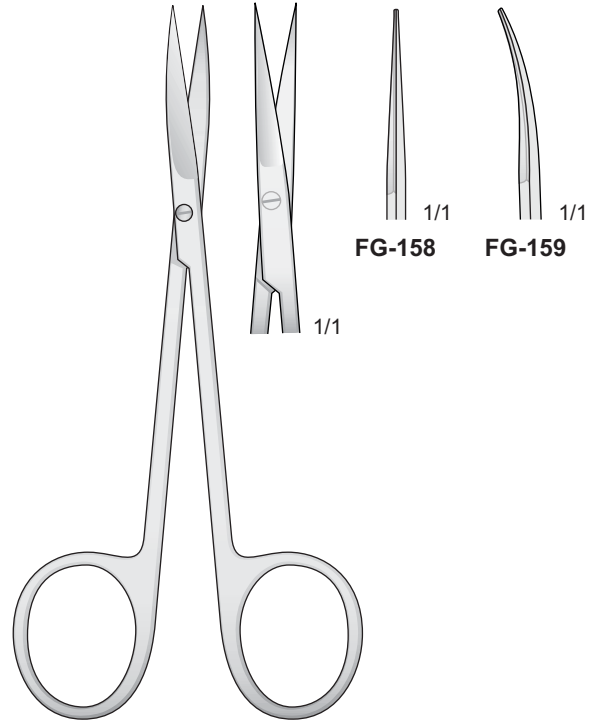

FG-158/FG-159
110 mm

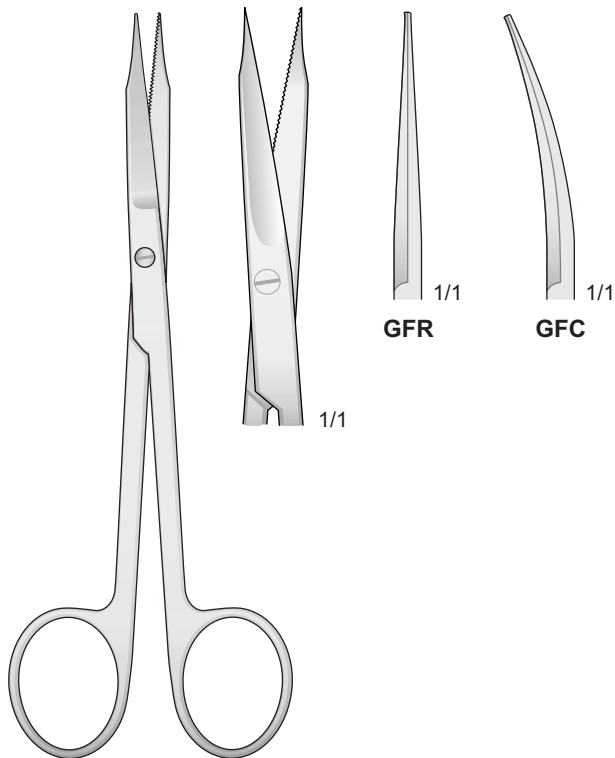

GOLDMAN-FOX
GFR/GFC
120 mm

03



Dentellate
Saw edge
Gezahnt
Dentelé
Dentadas

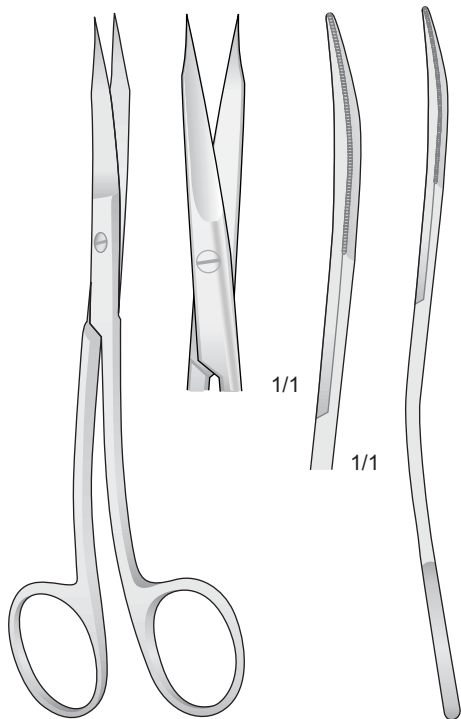

GOLDMAN-FOX S FORM
GFS
130 mm

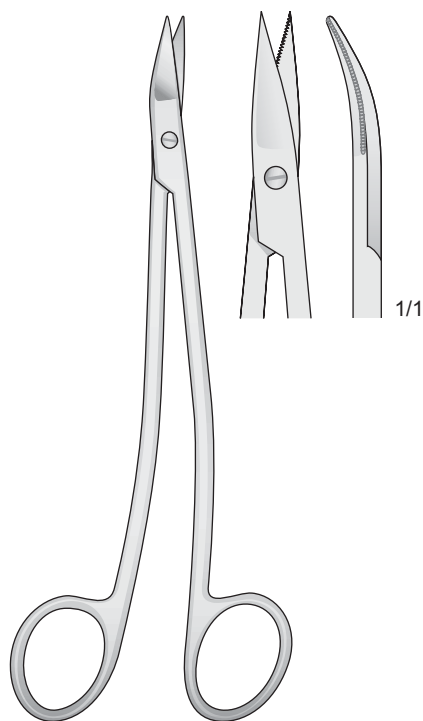

NEUMANN
FG-20
130 mm

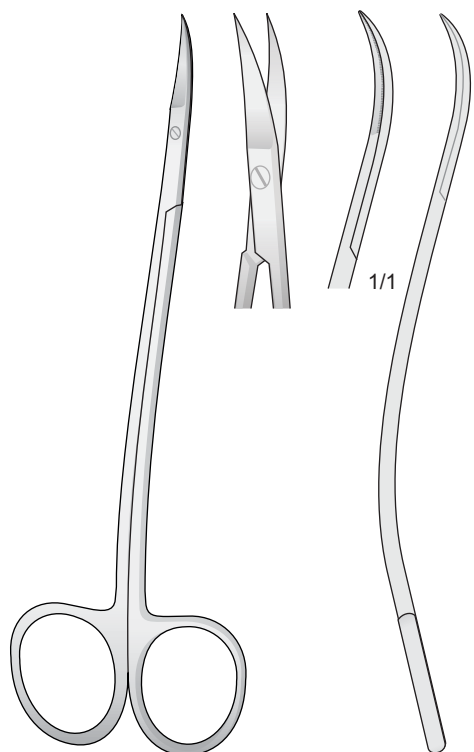

LA GRANGE
LG-1
115 mm

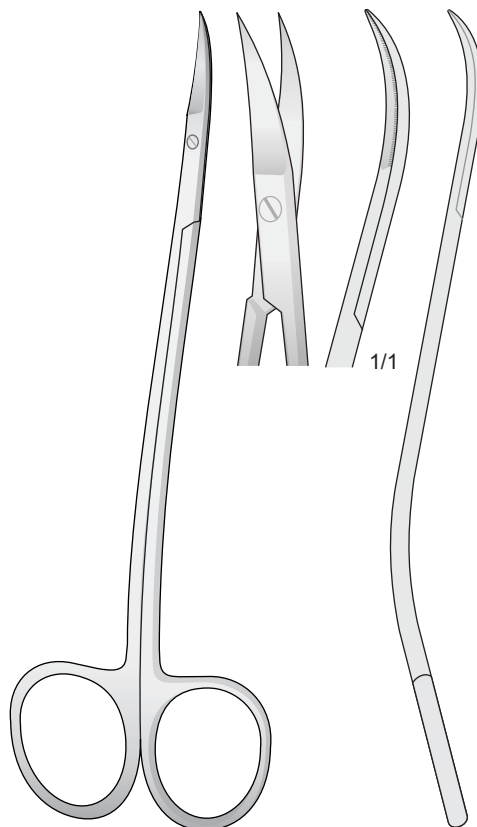

LA GRANGE
LG-6
155 mm

Smusse - Blunt - Stumpf - Mousses - Romas

Acute - Pointed - Spitz - Pointus - Agudas

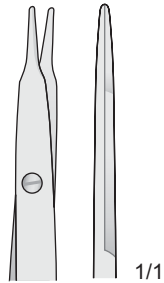
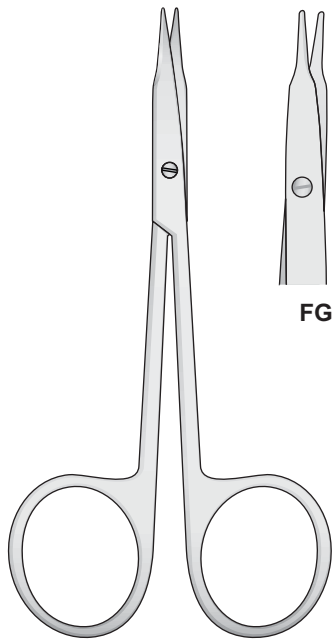

FG-50

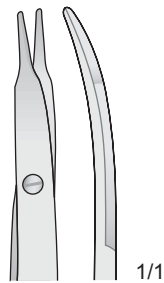

FG-51

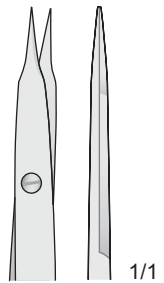

FG-52

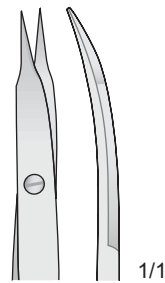

FG-53

STEVENS
FG-50/FG-53
110 mm

Smussa - Blunt - Stumpf
Mousse - Romas

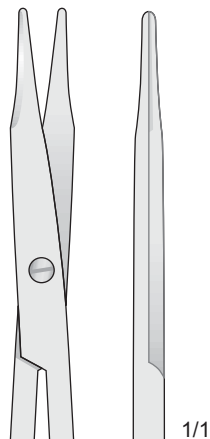
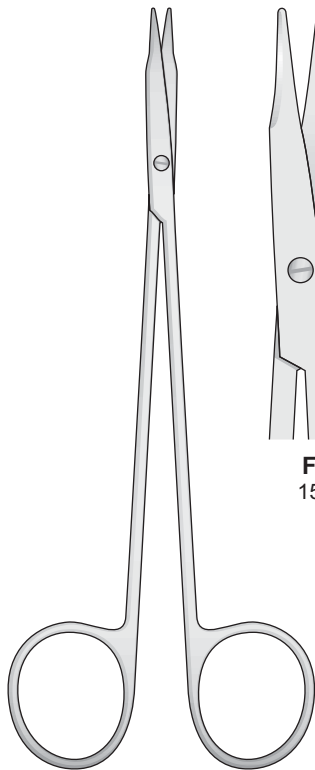

FG-54
150 mm

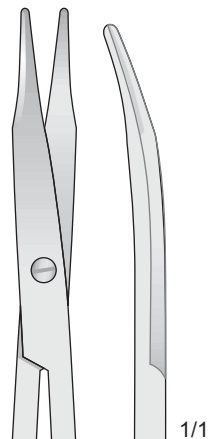

FG-55
150 mm

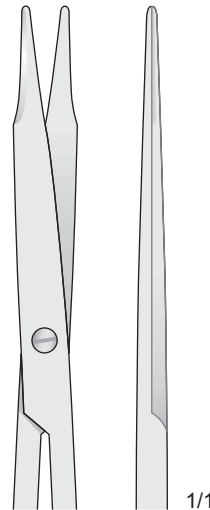

FG-56
180 mm

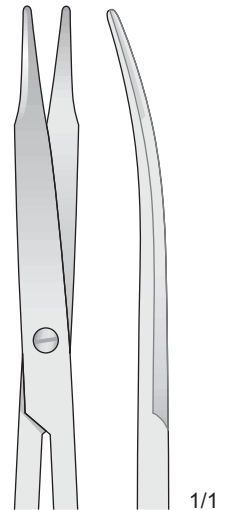

FG-57
180 mm

REYNOLDS
FG-54/FG-57

03

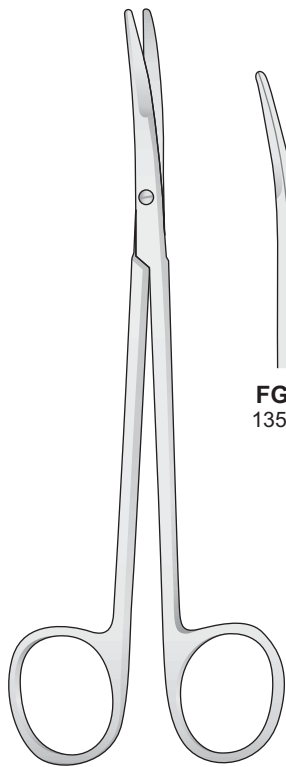

GLASSMAN
FG-68/FG-69

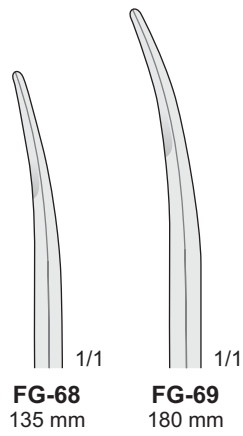

FG-68
135 mm

FG-69
180 mm

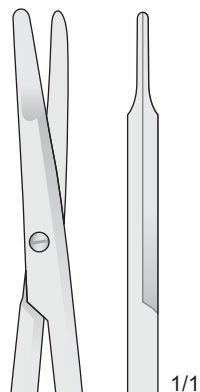

FG-66
120 mm

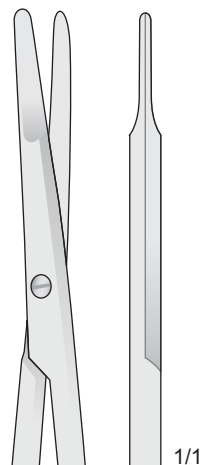

FG-19R
135 mm

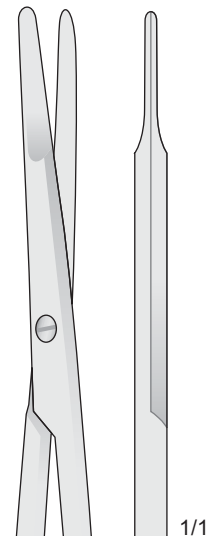

FG-6R
150 mm

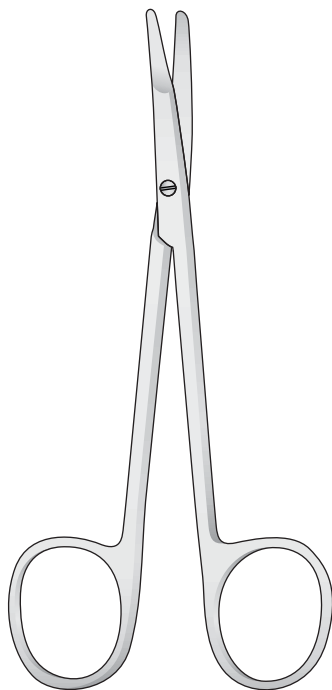

KILNER
FG-6C/FG-66

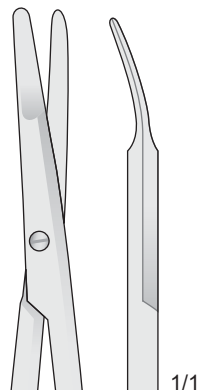

FG-67
120 mm

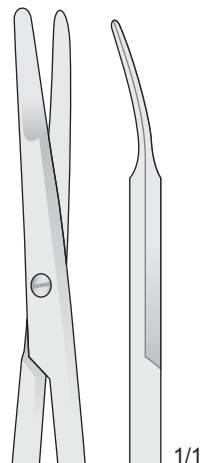

FG-19C
135 mm

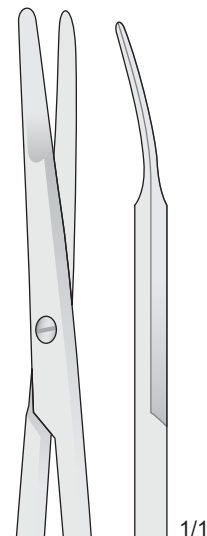

FG-6C
150 mm

Dentellate
Saw edge
Gezahnt
Dentelés
Dentadas

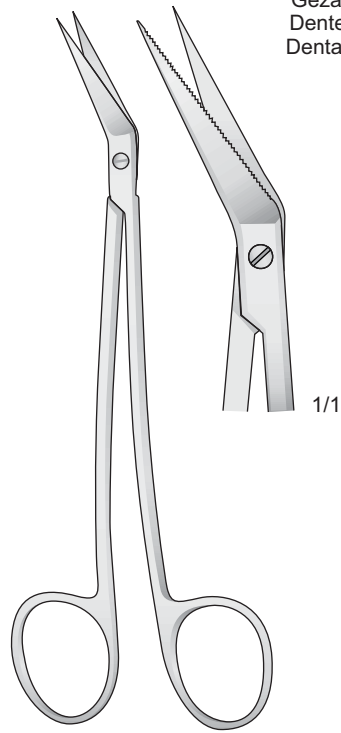

LOCKLIN
LK-2
160 mm

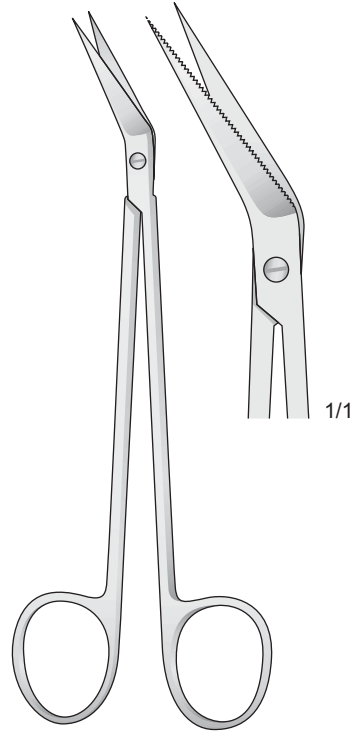

LOCKLIN
LK-4
160 mm

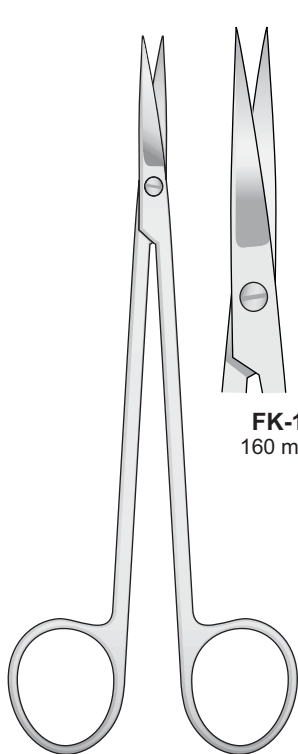

KELLY
FK-1/FK-87

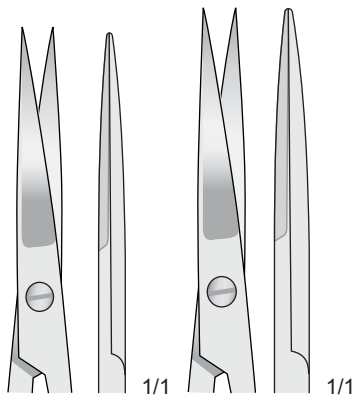

FK-1
160 mm

FK-87
180 mm

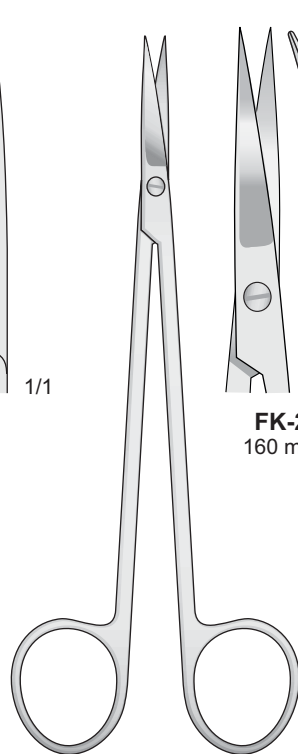

KELLY
FK-2/FK-88

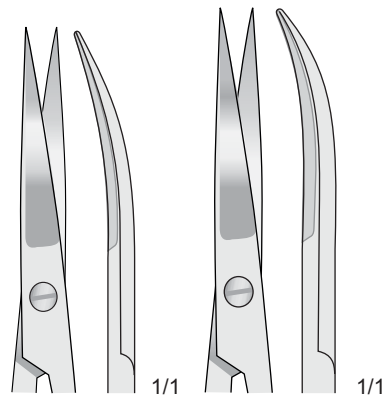

FK-2
160 mm

FK-88
180 mm

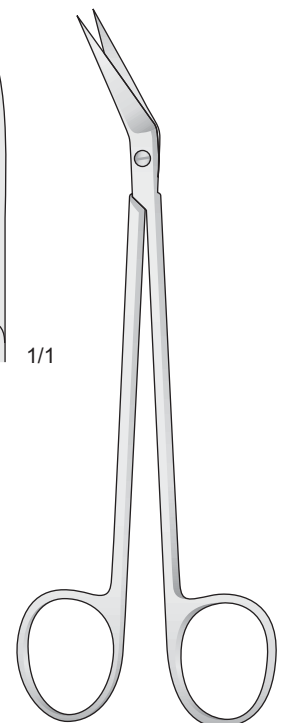

KELLY
FK-10
160 mm

03



Standard

Smusse
Blunt
Stumpf
Mousses
Romas

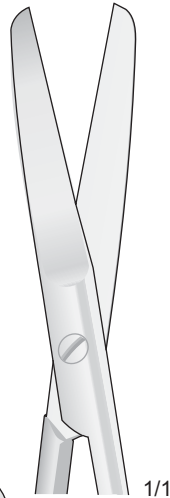
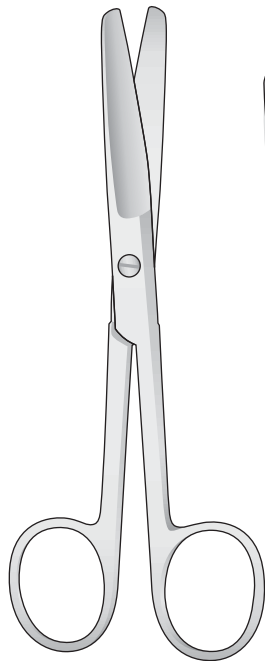

1/1

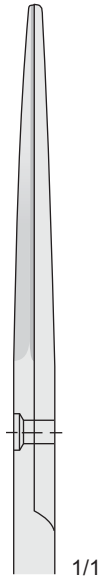

1/1

FM-35
130 mm

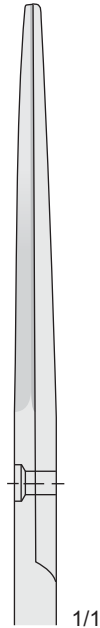

1/1

FM-9
145 mm

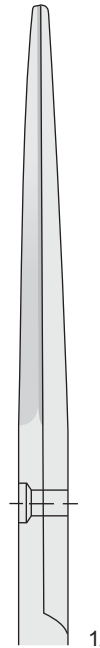

1/1

FM-37
165 mm

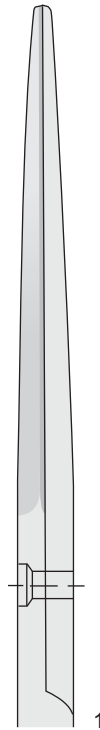

1/1

FM-39
185 mm

FM-9/FM-39

Smusse - Blunt
Stumpf - Mousses
Romas

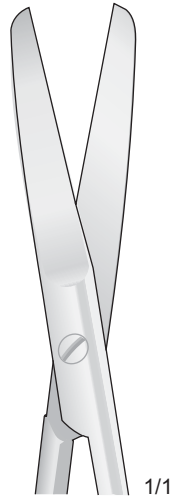
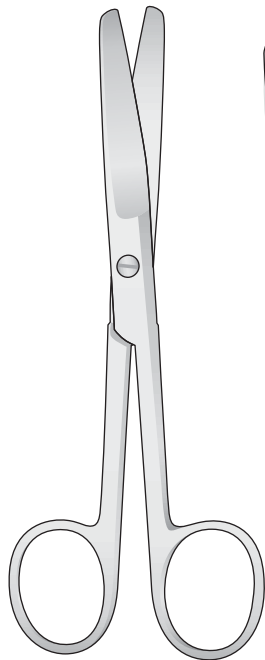

1/1

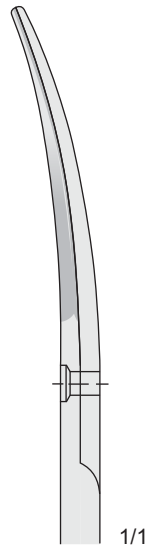

1/1

FM-36
130 mm

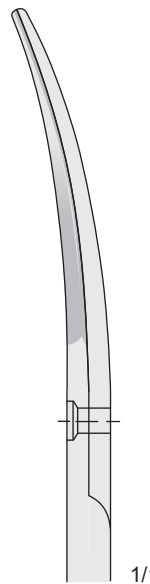

1/1

FM-10
145 mm

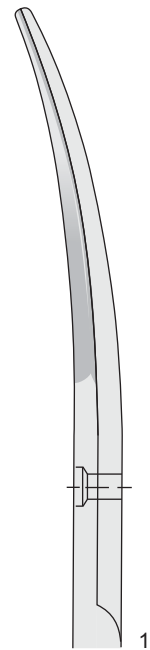

1/1

FM-38
165 mm

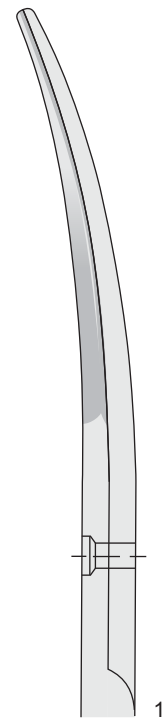

1/1

FM-40
185 mm

FM-10/FM-40

Standard

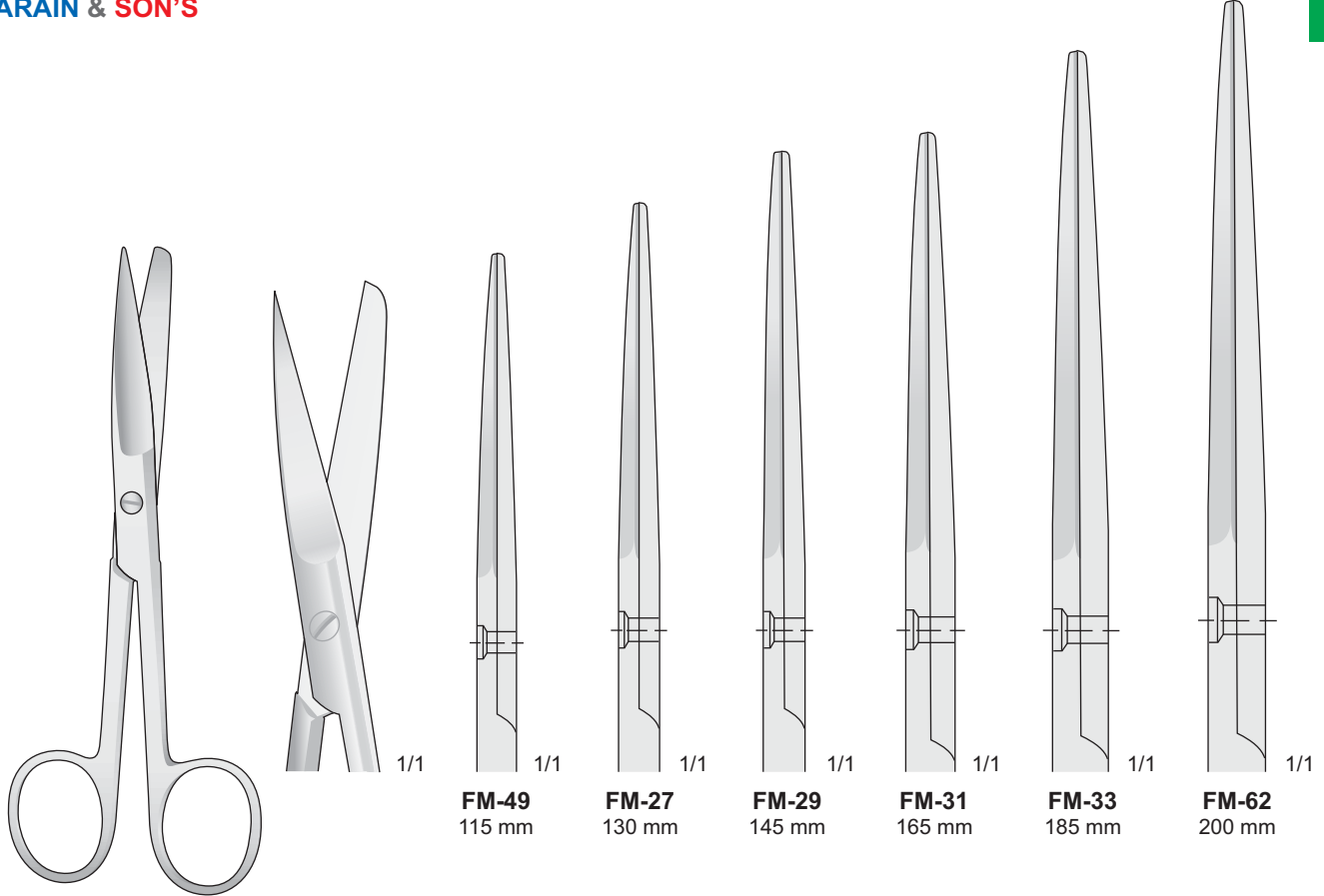

FM-27/FM-62

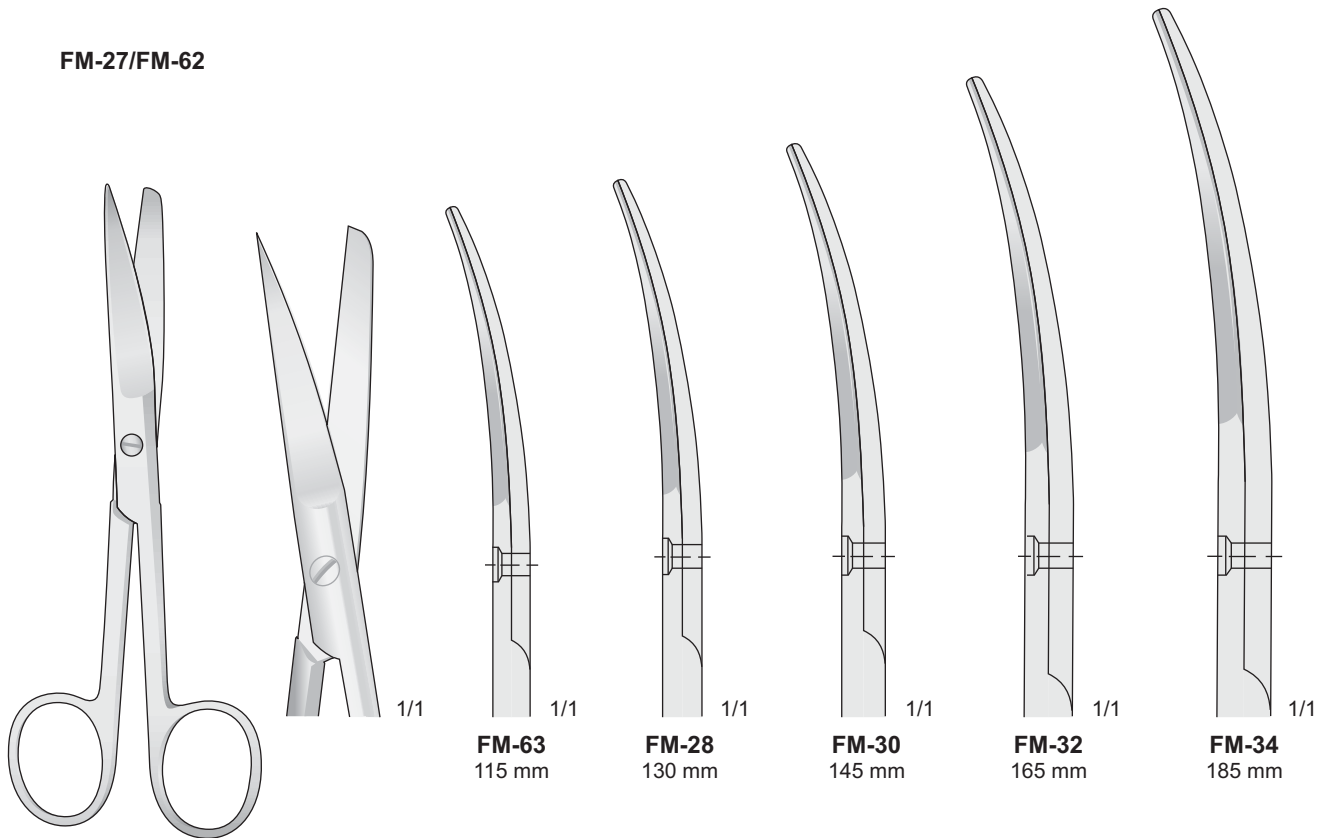

FM-28/FM-63

03



Standard

Acuta - Sharp
Spitz - Aigu - Agudo

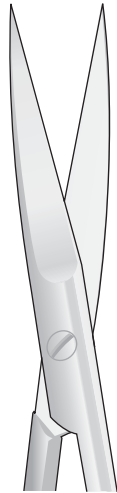
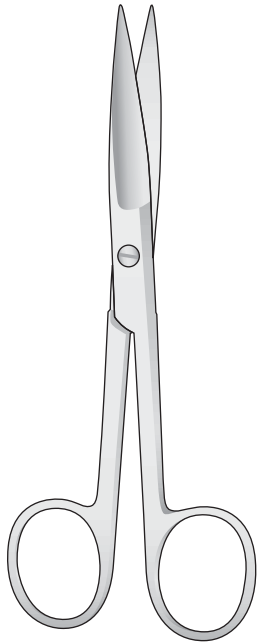

1/1

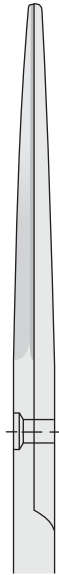

1/1

FM-41
130 mm

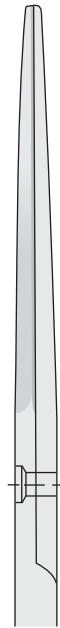

1/1

FM-7
145 mm

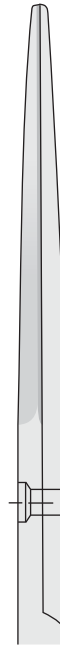

1/1

FM-43
165 mm

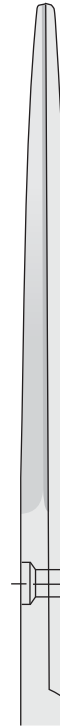

1/1

FM-45
185 mm

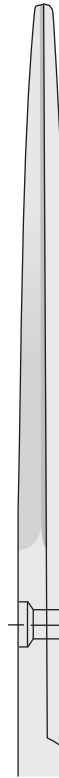

1/1

FM-72
200 mm

FM-41/FM-72

Acuta - Sharp
Spitz - Aigu - Agudo

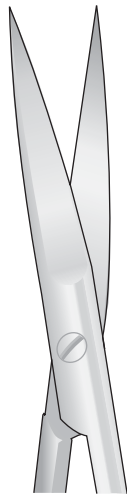
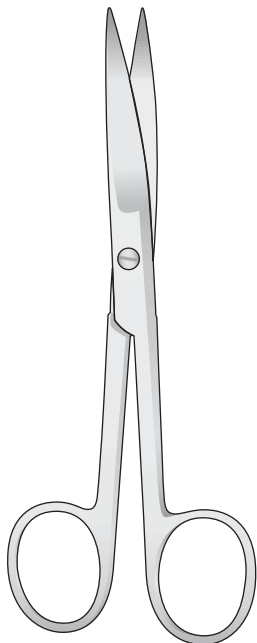

1/1

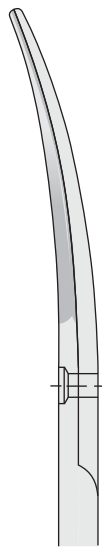

1/1

FM-42
130 mm

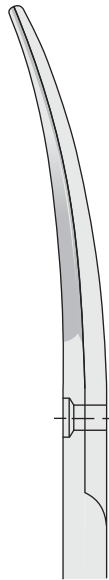

1/1

FM-8
145 mm



1/1

FM-44
165 mm



1/1

FM-46
185 mm

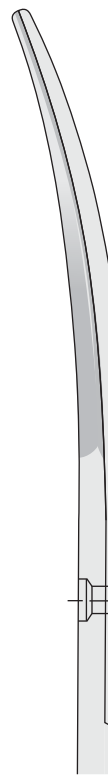

1/1

FM-73
200 mm

FM-8/FM-73

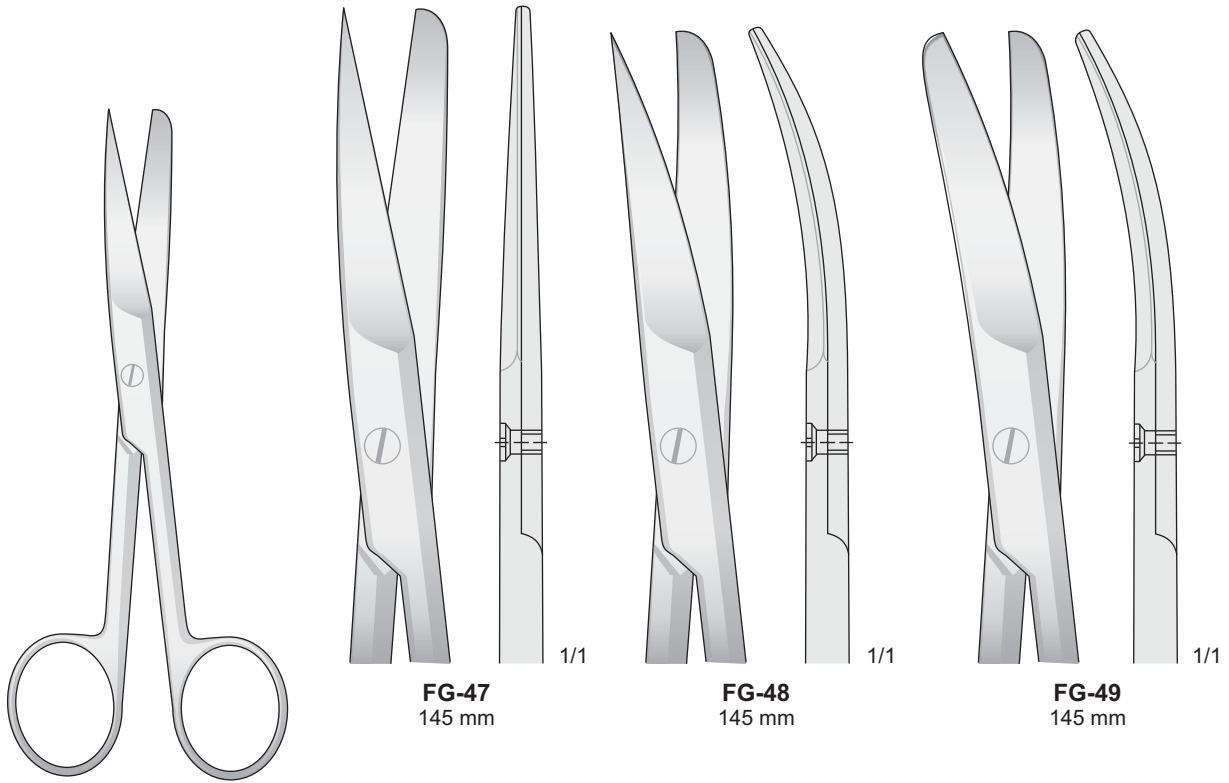

DEAVER
FG-47/FG-49
145 mm

Forbici da incisione - Incision scissors
Inzisionscheren - Ciseaux à incision
Tijeras para incisión

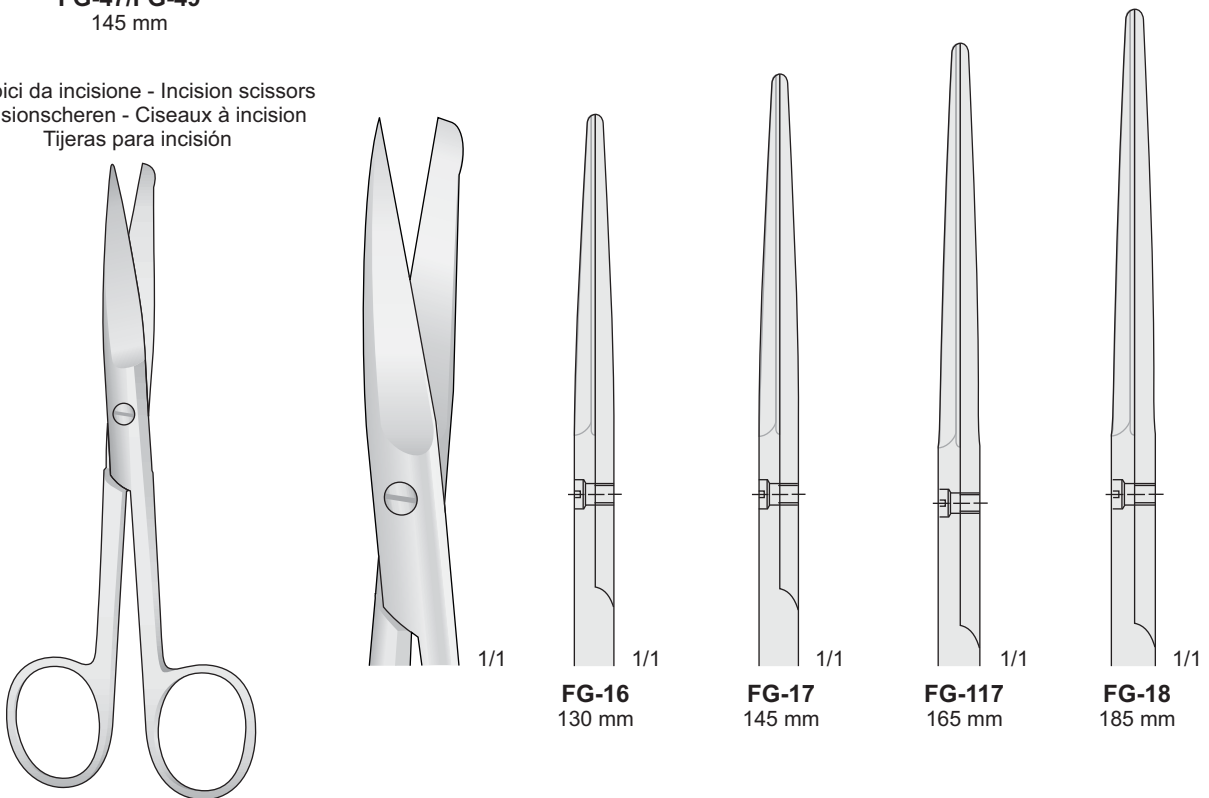

FG-16/FG-18

03

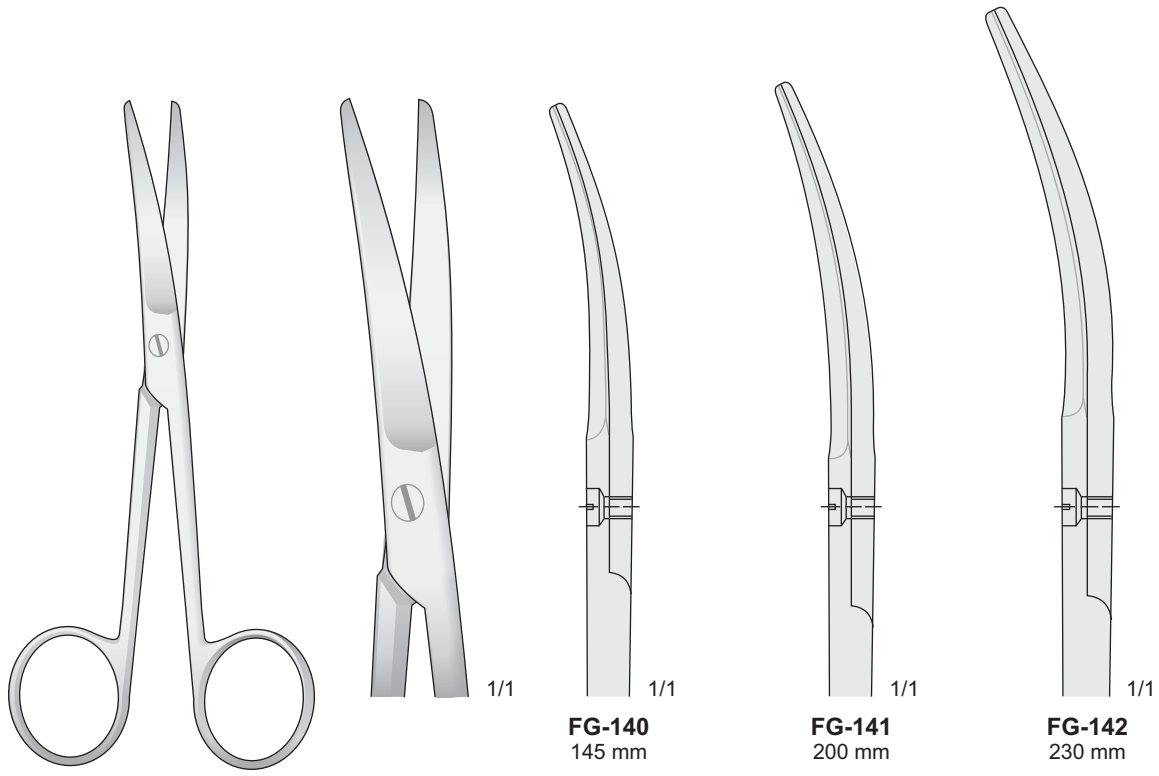

**WERTHEIM
FG-140/FG-142**

Con una lama dentellata
With one blade serrated
Mit eine Schneide gezahnt
Avec lame dentèle
Con una hoja dentada

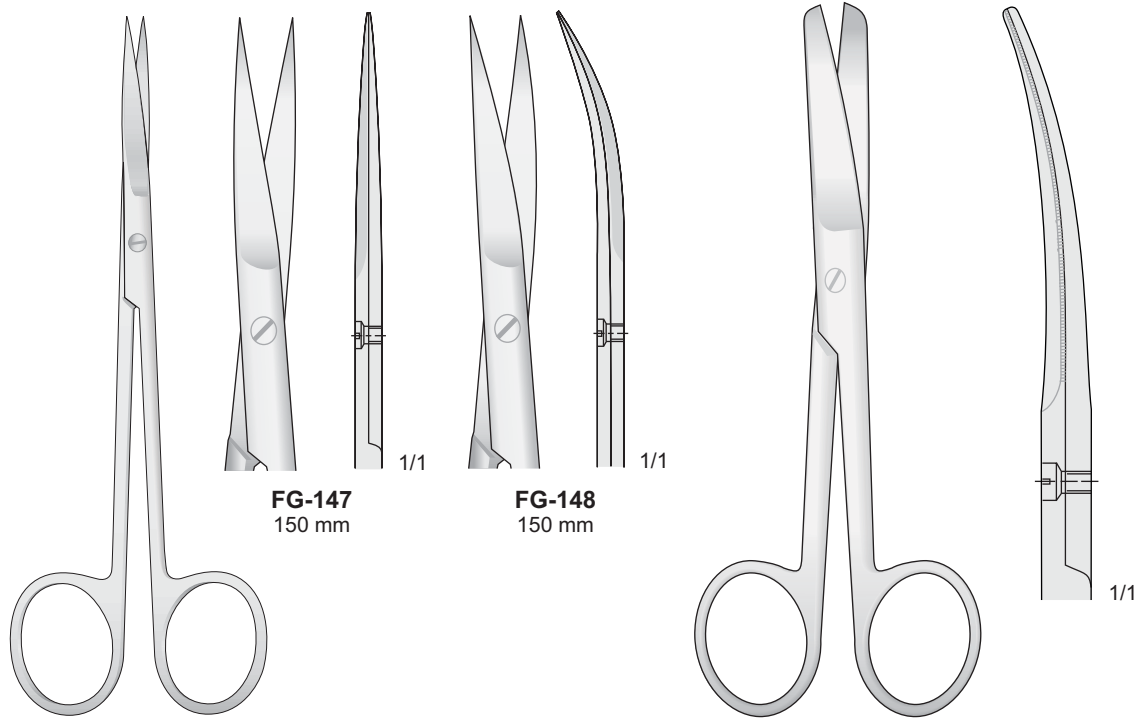

**JOSEPH
FG-147/FG-148
150 mm**

**FG-116
165 mm**



Con occhiello per sutura - With eye for suture
Mit faden bohrung - Avec oeil pour les sutures
Tijeras para ligaduras

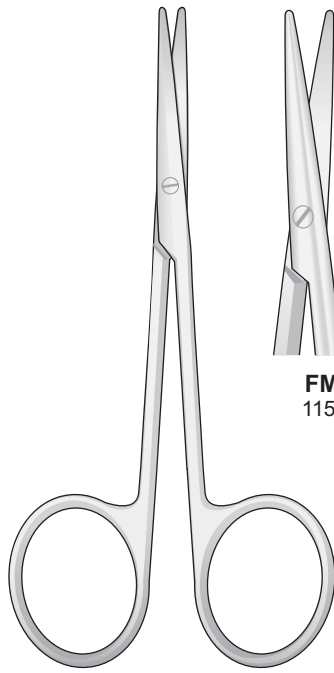

BABY - METZENBAUM
FM-47/FM48
115 mm

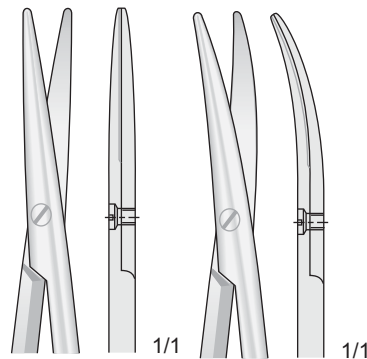

FM-47
115 mm

FM-48
115 mm

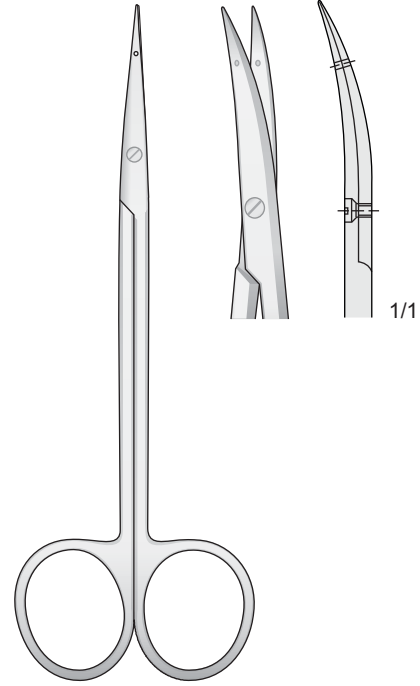

LITTLER
FG-100
120 mm

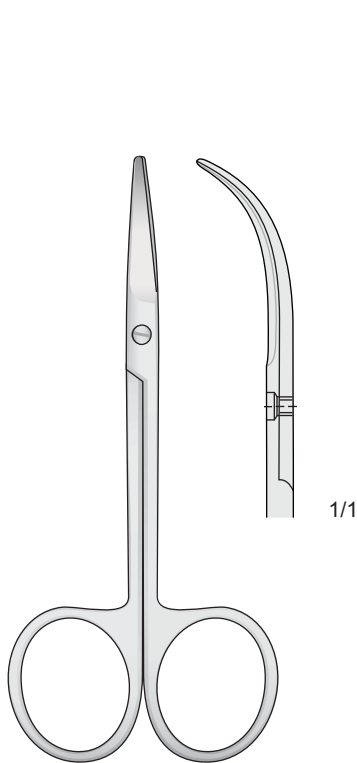
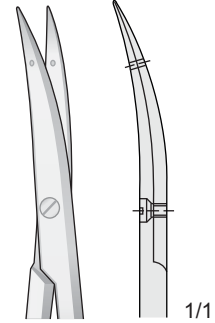

FOMON
FG-43
110 mm

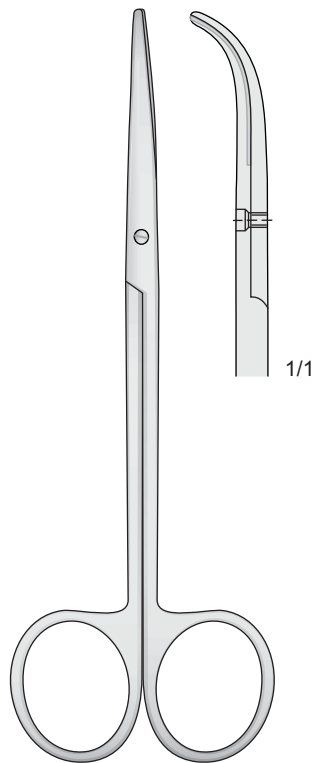

FG-44
140 mm

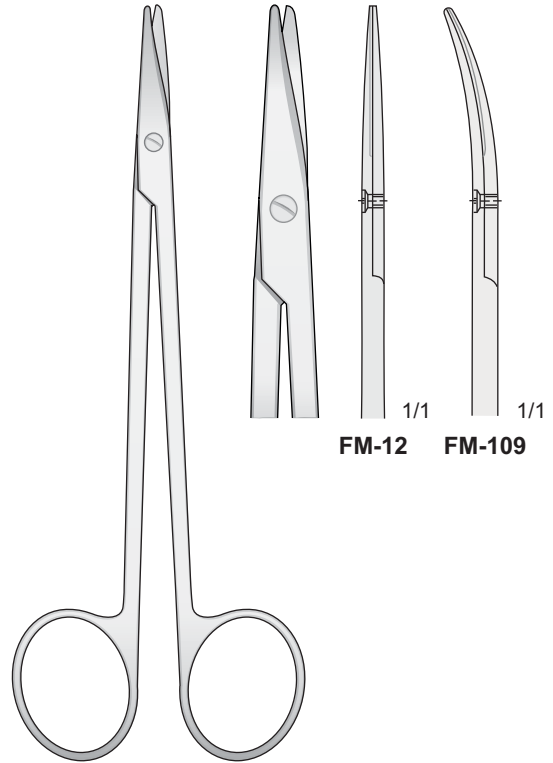

METZENBAUM
FM-12/FM-109
150 mm

FM-12 FM-109

Forbici per dissezione - Dissecting Scissors
 Präparierscheren - Ciseaux à dissection - Tijeras para preparaciones

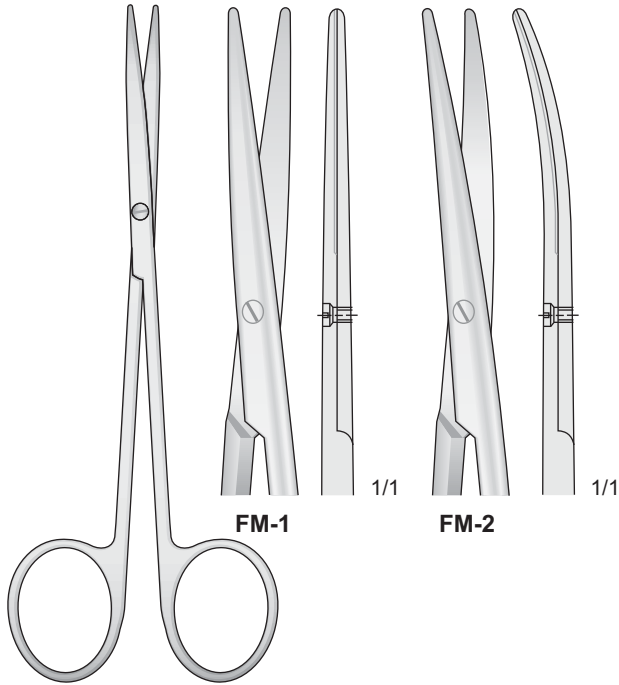

METZENBAUM
FM-1/FM-2
 145 mm

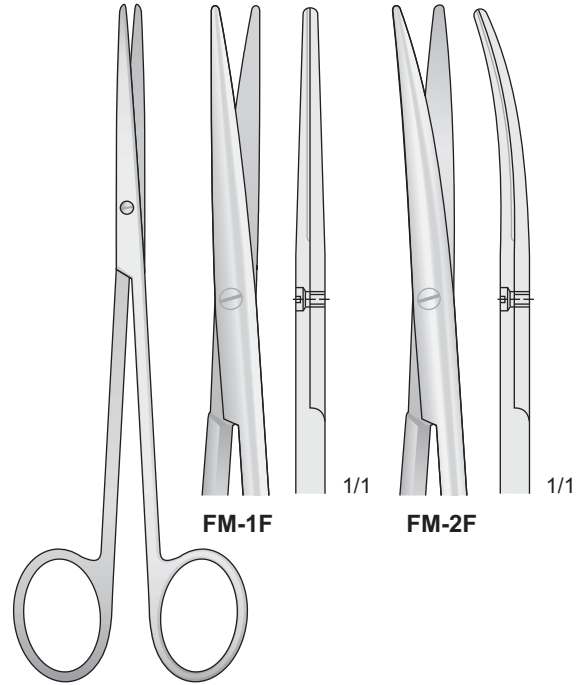

METZENBAUM-FINE
FM-1F/FM-2F
 145 mm

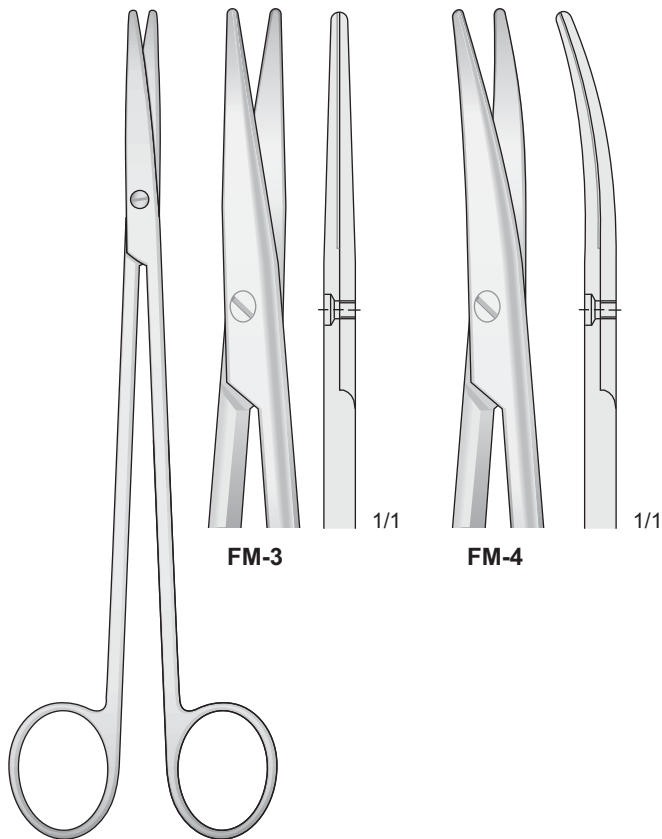

METZENBAUM
FM-3/FM-4
 185 mm

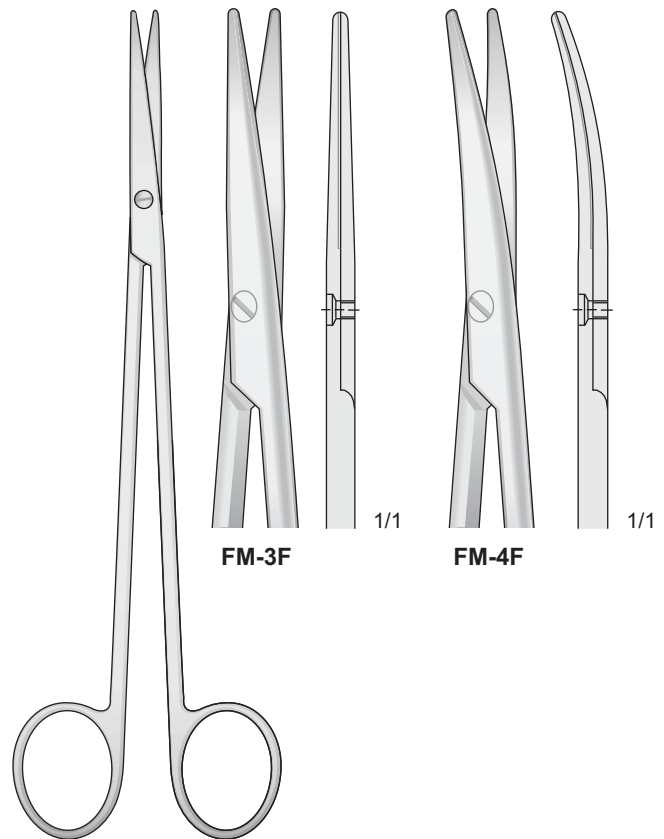

METZENBAUM-FINE
FM-3F/FM-4F
 185 mm

Forbici per dissezione - Dissecting Scissors
Präparierscheren - Ciseaux à dissection - Tijeras para preparaciones

Acuta - Sharp
Spitz - Aigu - Agudo

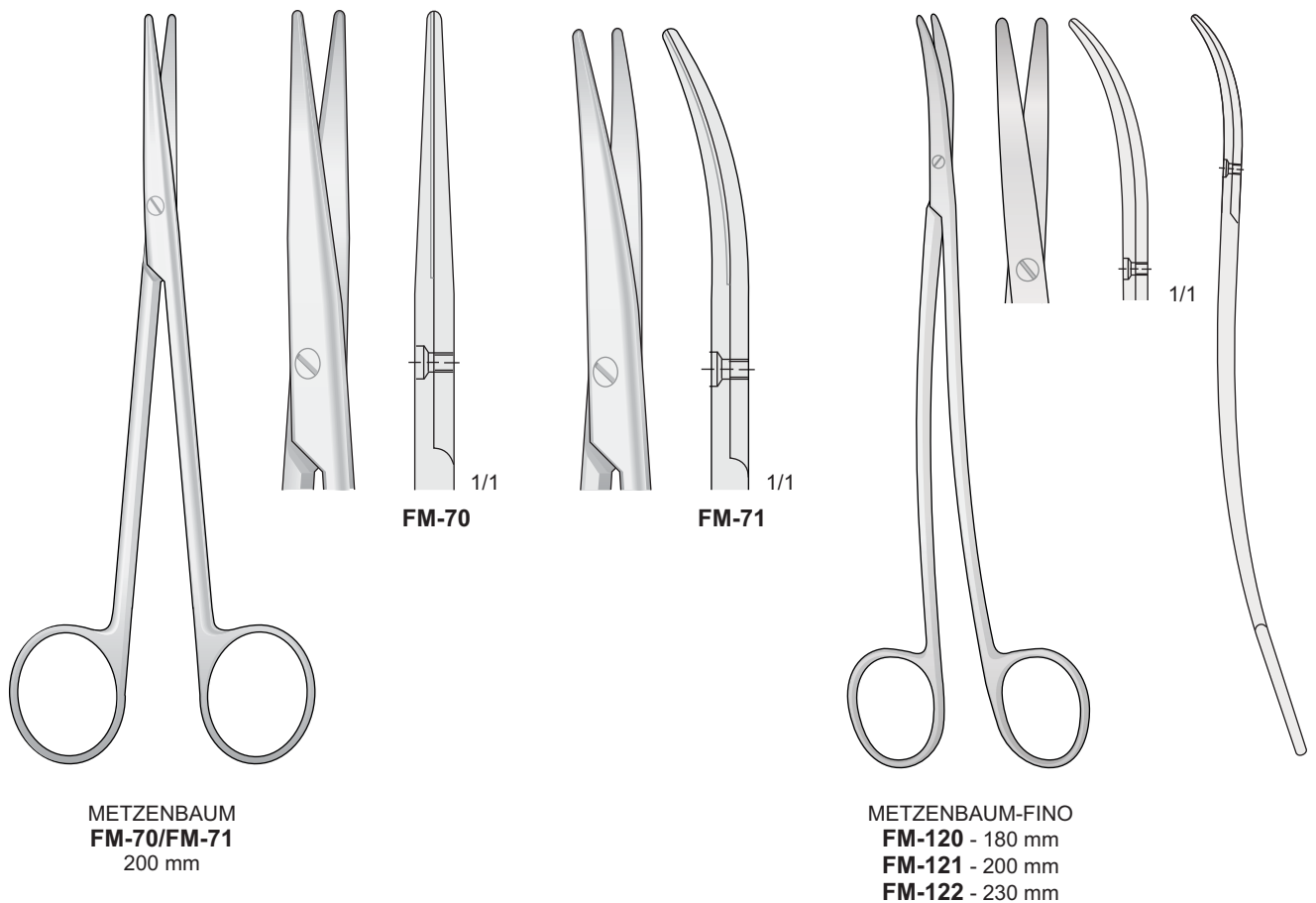
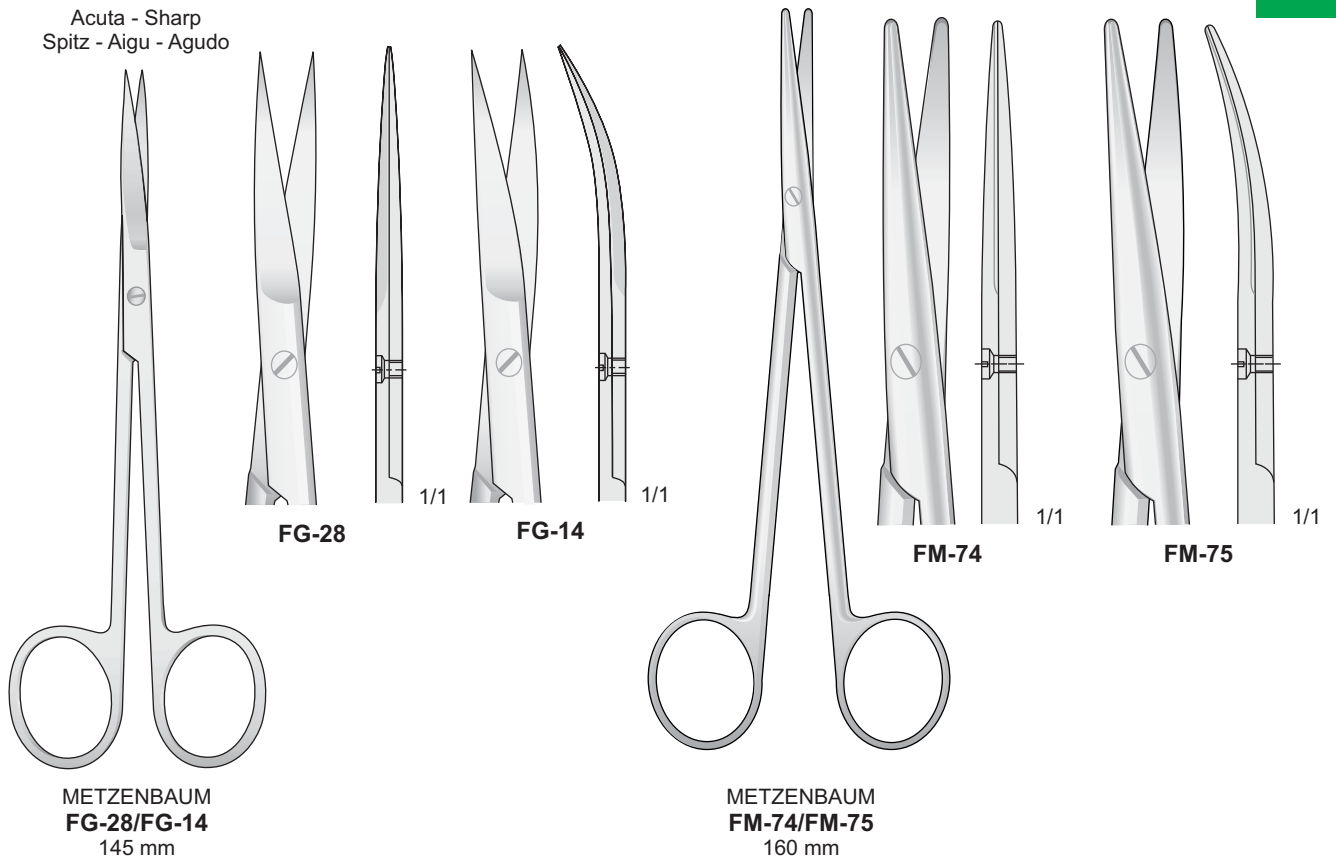

03

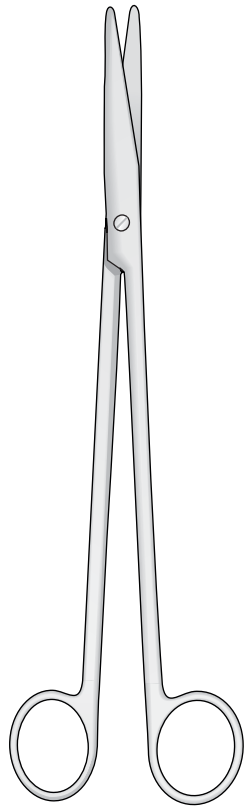

NELSON-METZENBAUM
FM-11/FM-114

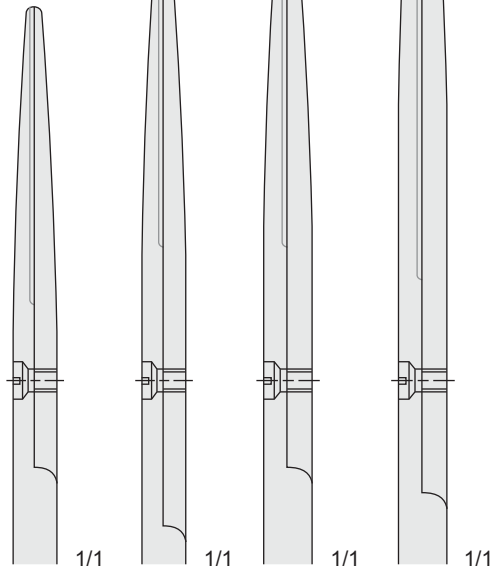
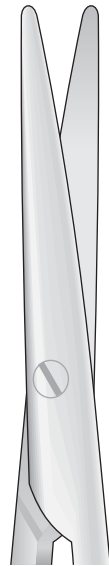

FM-11 230 mm **FM-112** 250 mm **FM-113** 280 mm **FM-114** 305 mm

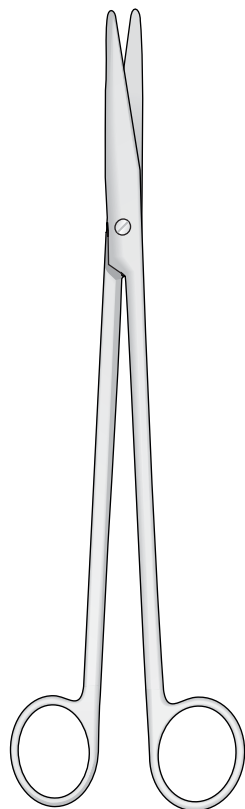

NELSON-METZENBAUM
FM-13/FM-117

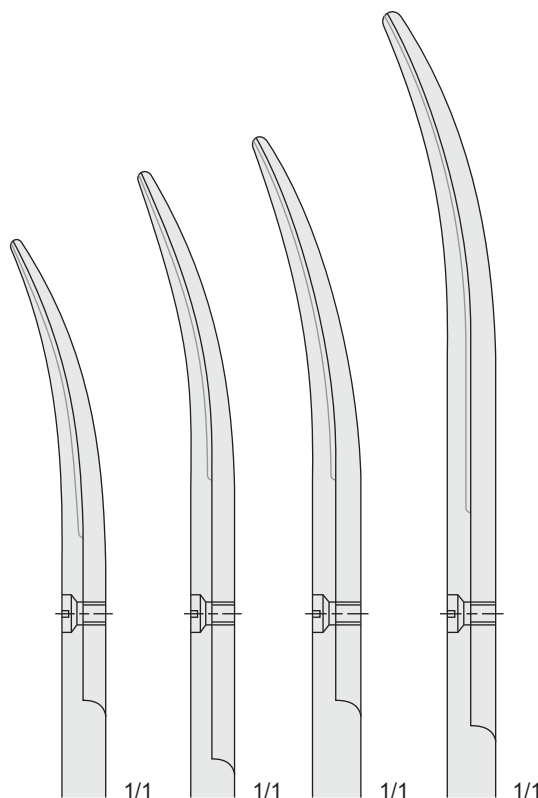

FM-13 230 mm **FM-115** 250 mm **FM-116** 280 mm **FM-117** 305 mm

Fine - Delicate - Fein - Fins - Finas

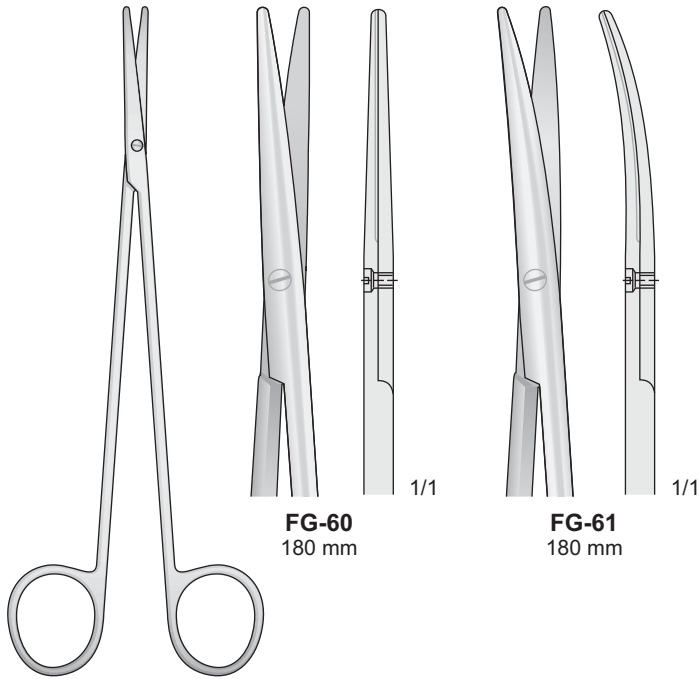

FG-60
180 mm

FG-61
180 mm

TOENNIS-ADSON
FG-60/FG-61
180 mm

Fine - Delicate - Fein - Fins - Finas

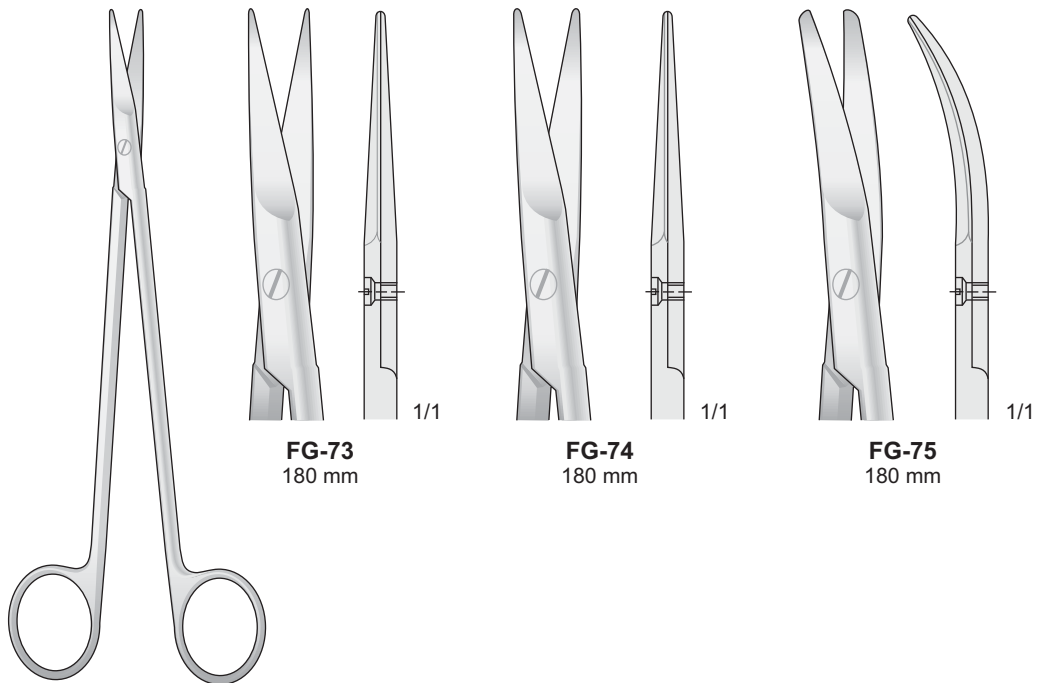

FG-73
180 mm

FG-74
180 mm

FG-75
180 mm

TOENNIS
FG-73/FG-75
180 mm

03



Forbici per dissezione - Dissecting scissors - Präparierscheren - Ciseaux à dissection - Tijeras para preparaciones

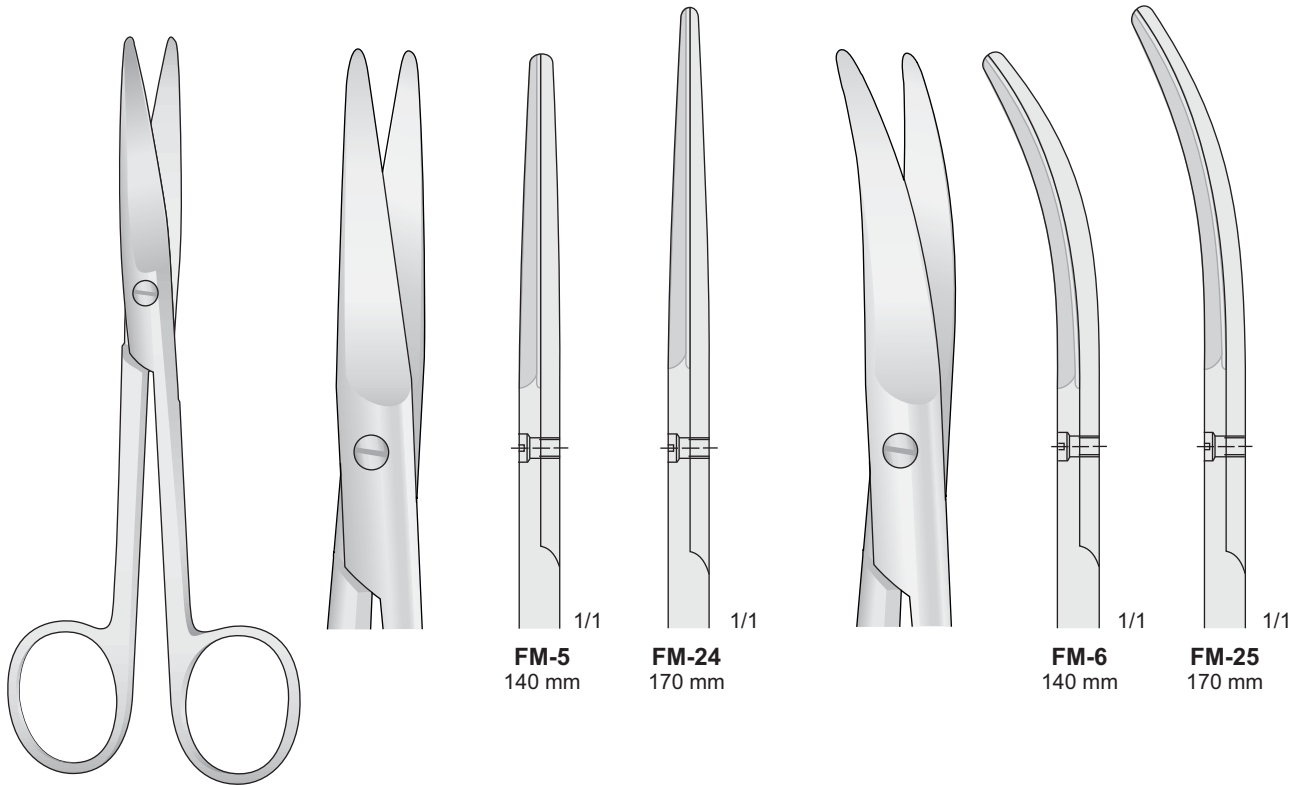

MAYO
FM-5/FM-25

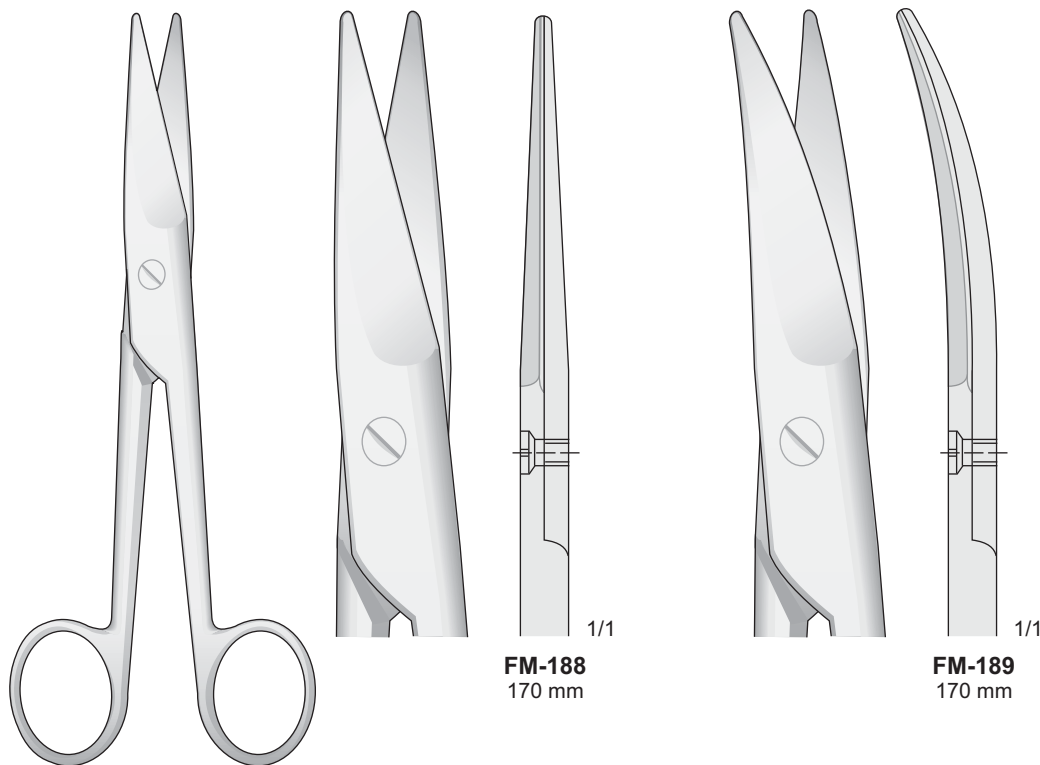

MAYO-NOBLE
FM-188/FM-189

Forbici per dissezione - Dissecting scissors - Präparierscheren - Ciseaux à dissection - Tijeras para preparaciones

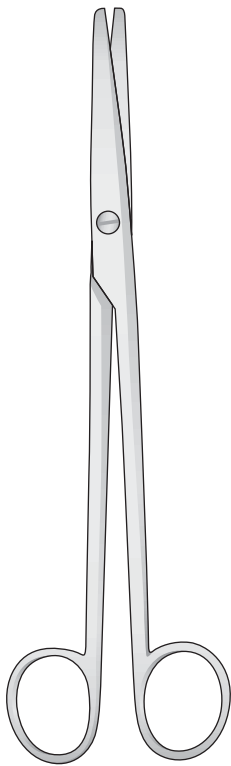

MAYO
FM-80/FM-82

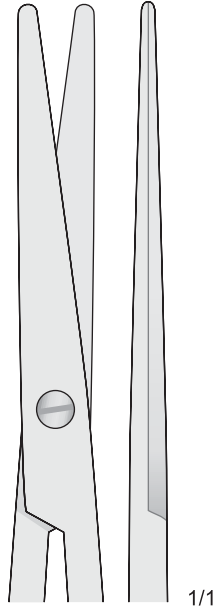

FM-80
160 mm

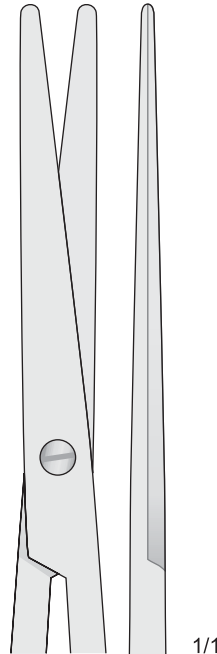

FM-81
190 mm

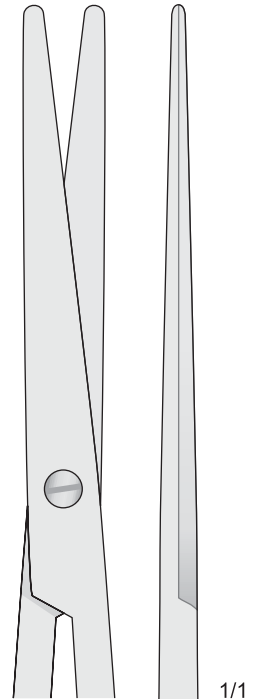

FM-82
210 mm

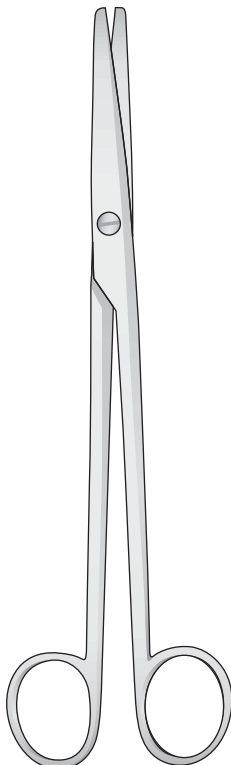

MAYO
FM-83/FM-85

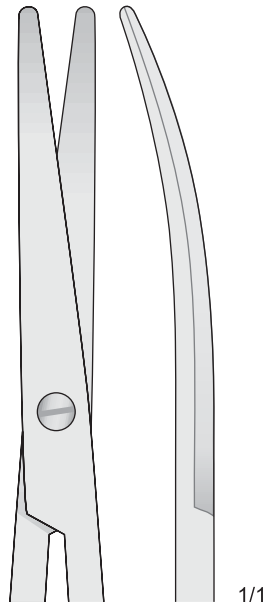

FM-83
160 mm

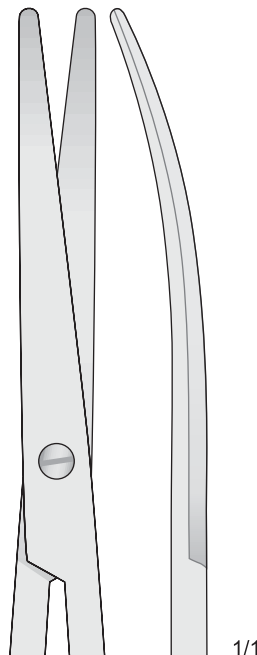

FM-84
190 mm

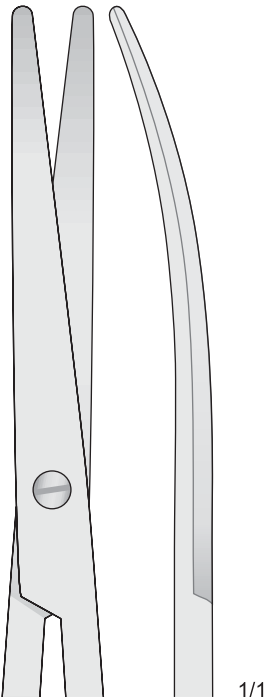

FM-85
210 mm

03



Fine - Delicate - Fein - Fins - Finas

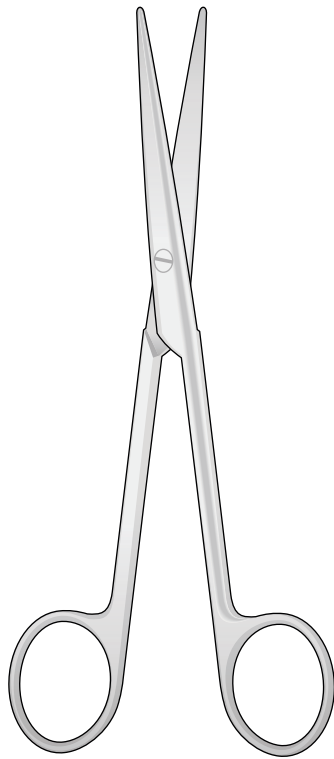

LEXER
FM-180/FM-181
165 mm

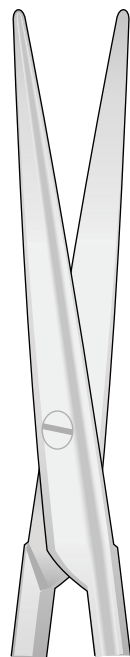

FM-180

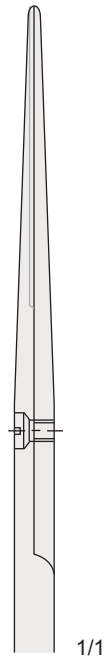

1/1

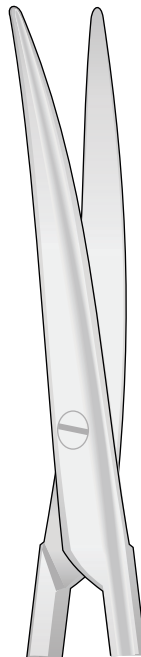

FM-181



1/1

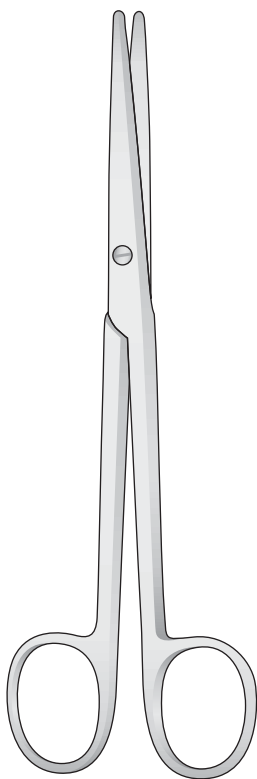

LEXER
FM-86/FM-89

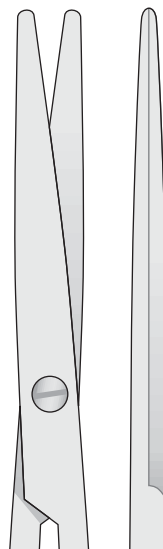

FM-86
160 mm

1/1



FM-87
210 mm

1/1

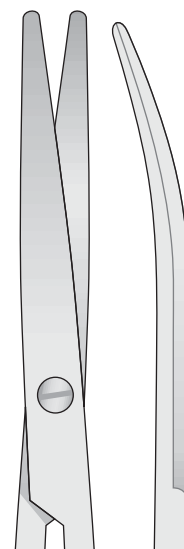

FM-88
160 mm

1/1

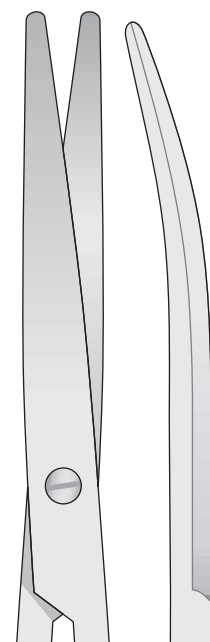

FM-89
210 mm

1/1

Forbici per dissezione - Dissecting Scissors - Präparierscheren - Ciseaux à dissection - Tijeras para preparaciones



FM-110
150 mm

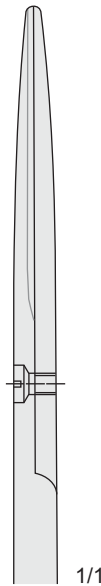

1/1



FM-111
150 mm



1/1

STILLE
FM-110/FM-111
150 mm

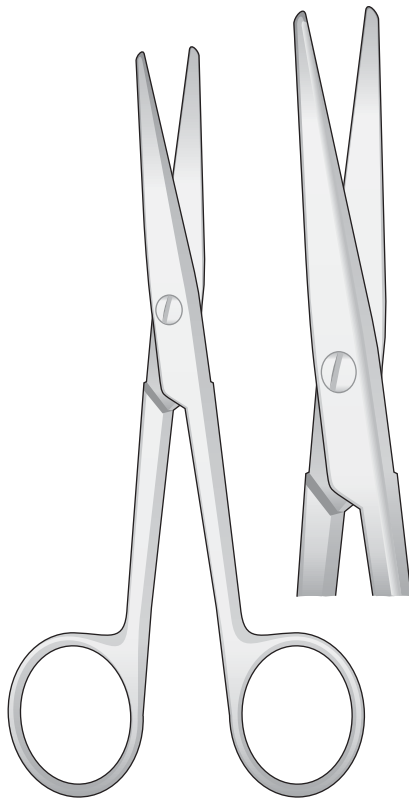

MAYO-STILLE
FM-76/FM-79

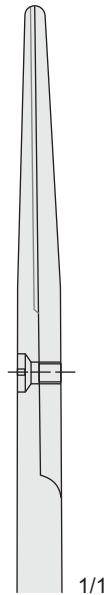

1/1

FM-76
140 mm

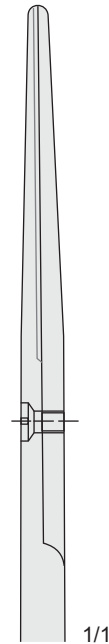

1/1

FM-77
170 mm

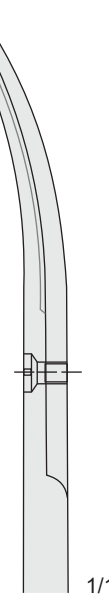
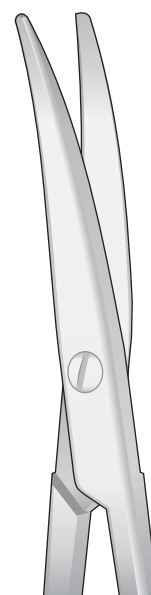

1/1

FM-78
140 mm

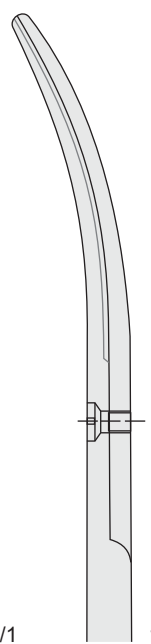

1/1

FM-79
170 mm

Forbici per dissezione a taglio bilaterale - Bilateral Dissecting Scissors
 Präparierscheren - Ciseaux à dissection - Tijeras para preparaciones

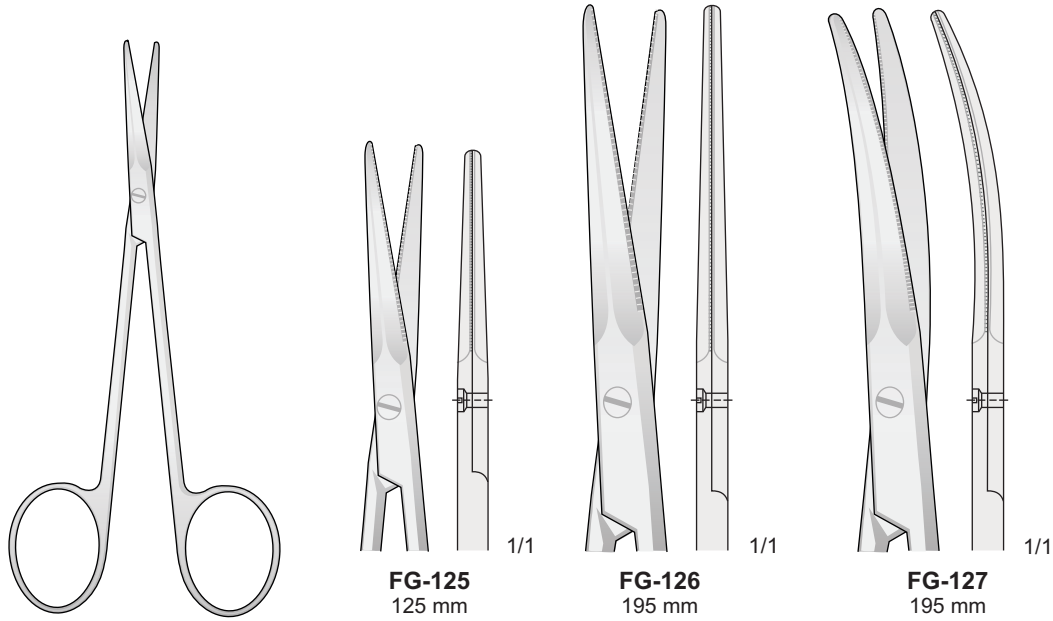

GORNEY
 FG-125/FG-127

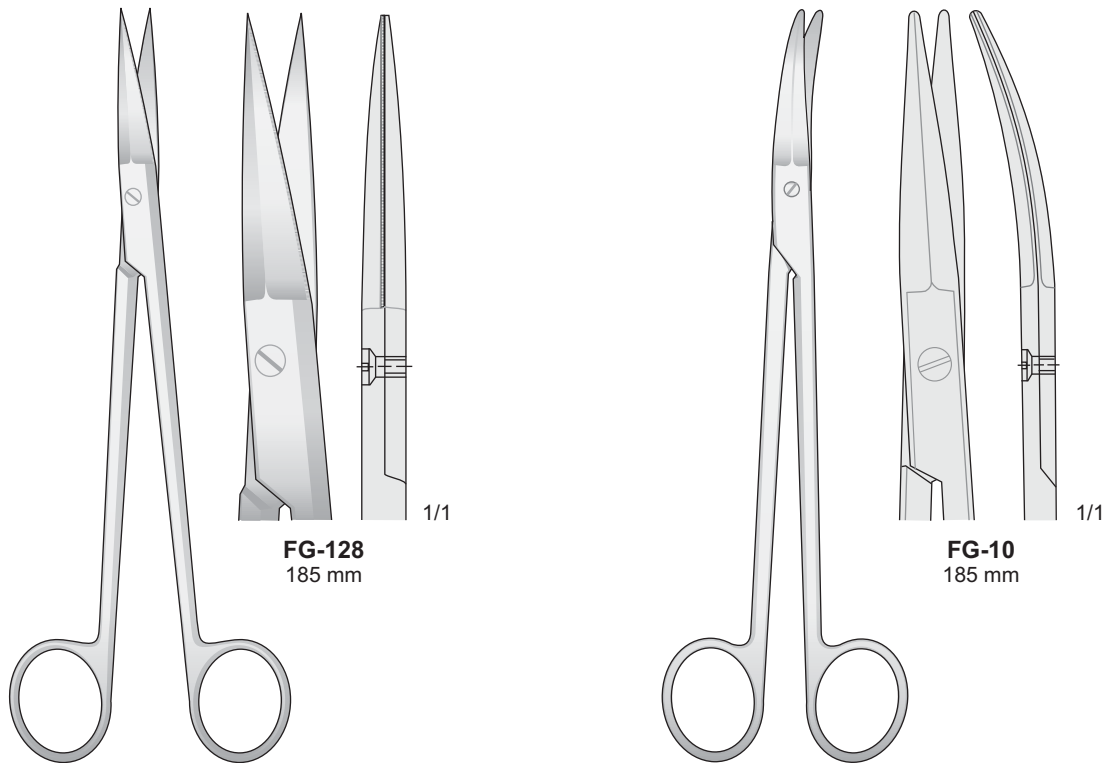

FG-128
 185 mm

FG-10
 185 mm

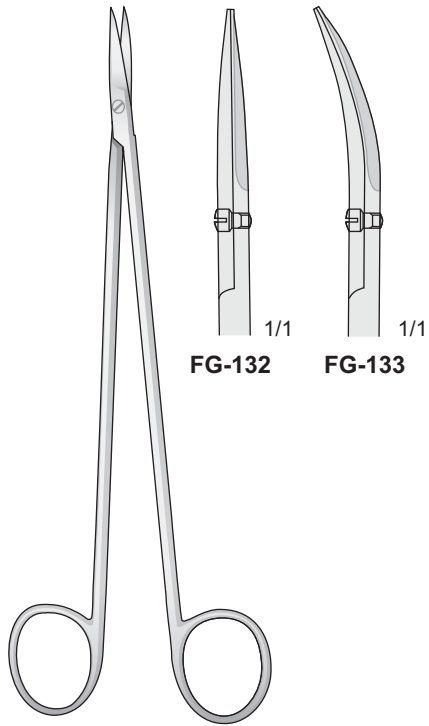

FG-132

FG-133

FG-132/FG-133
190 mm

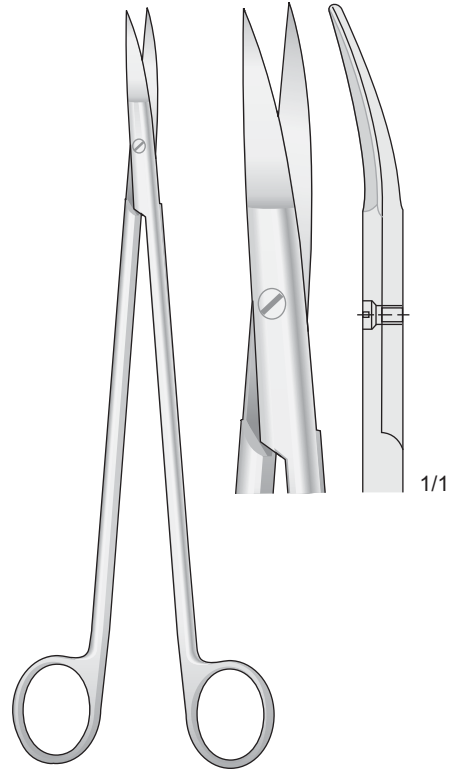

STRULLY
FG-106
220 mm

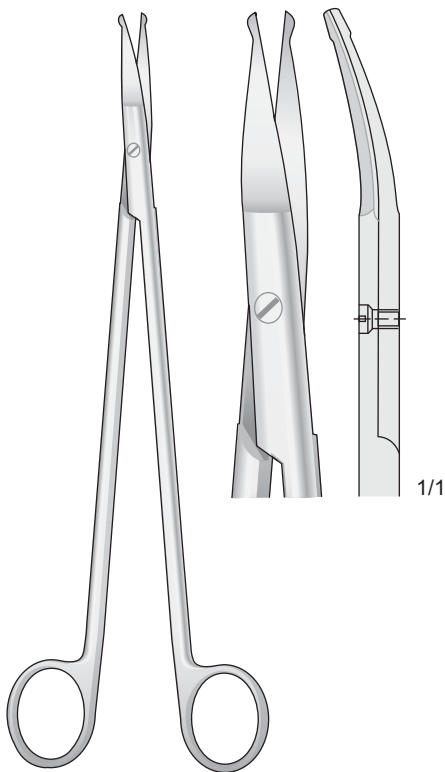

STRULLY
FG-107
220 mm

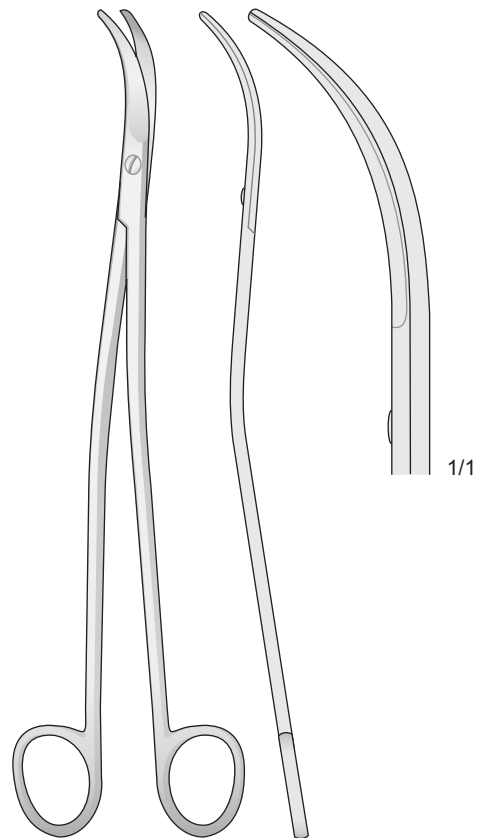

SATINSKY
FG-88
245 mm

Dentellata - Serrated - Gezahnt - Dentelé - Dentadas

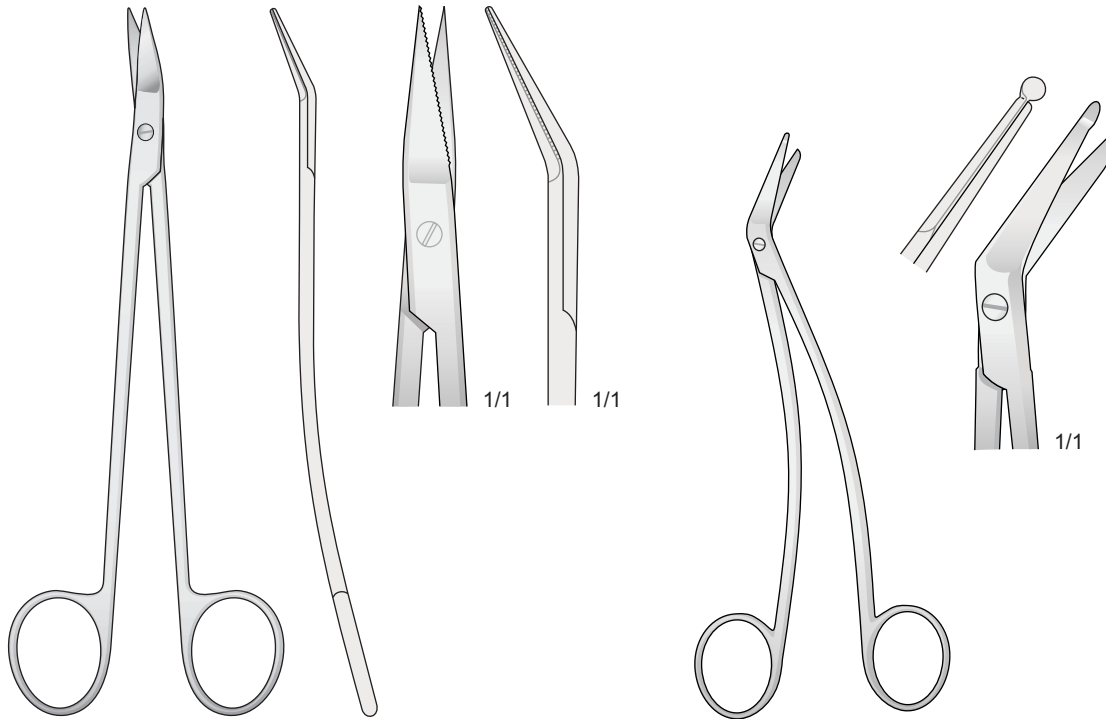

DEAN
DEAN
180 mm

SCHMIEDEN-TAYLOR
FG-152
155 mm

Dentellata - Serrated - Gezahnt - Dentelé - Dentadas

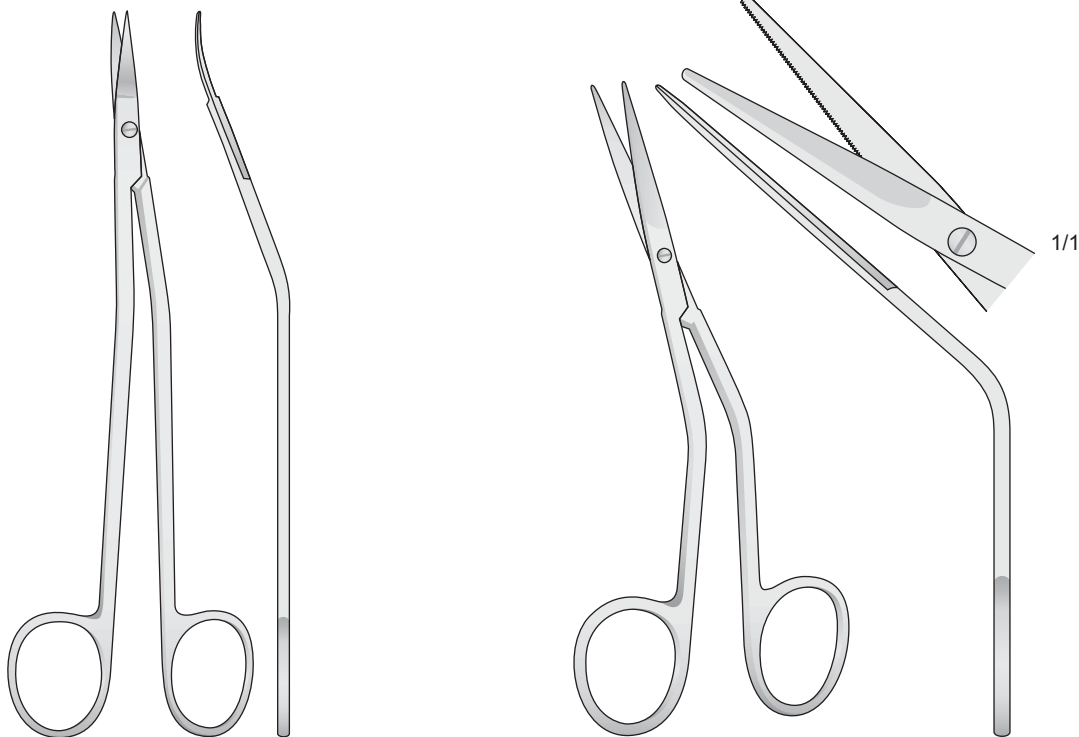

DANDY
FG-42
175 mm

FOMON
FG-41
135 mm

Forbici nasali - Nasal Scissors - Nasenscheren - Ciseaux nasaux - Tijeras nasales

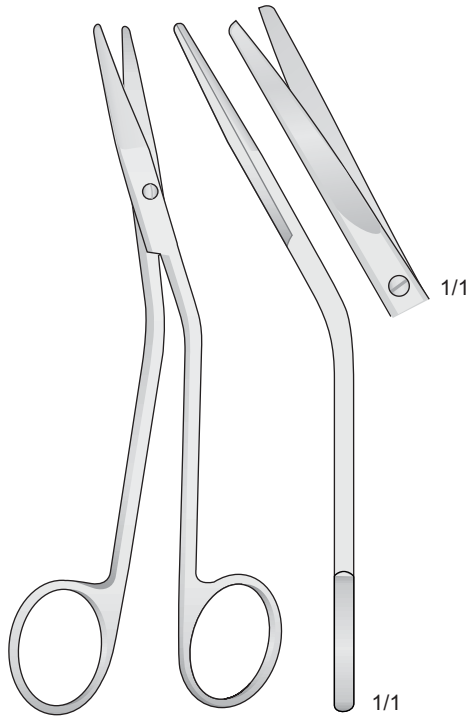

FOMON
FG-7
150 mm



HEYMANN
FG-8
180 mm

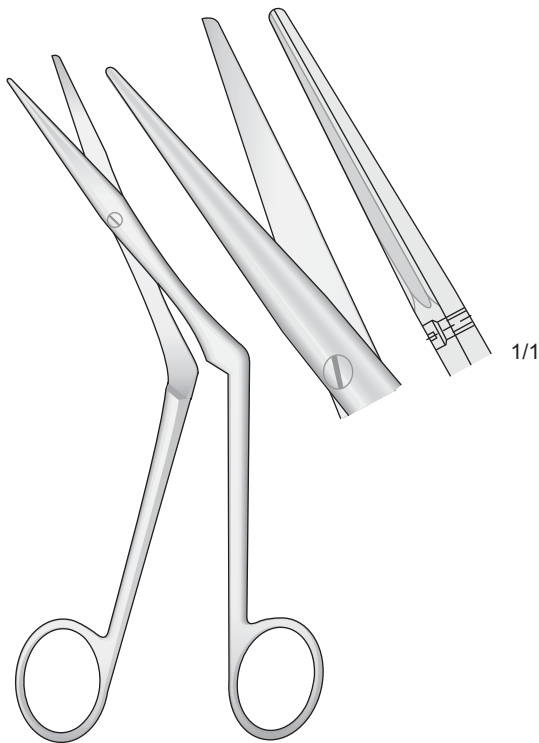

HEYMANN-KNIGHT
FG-99
175 mm

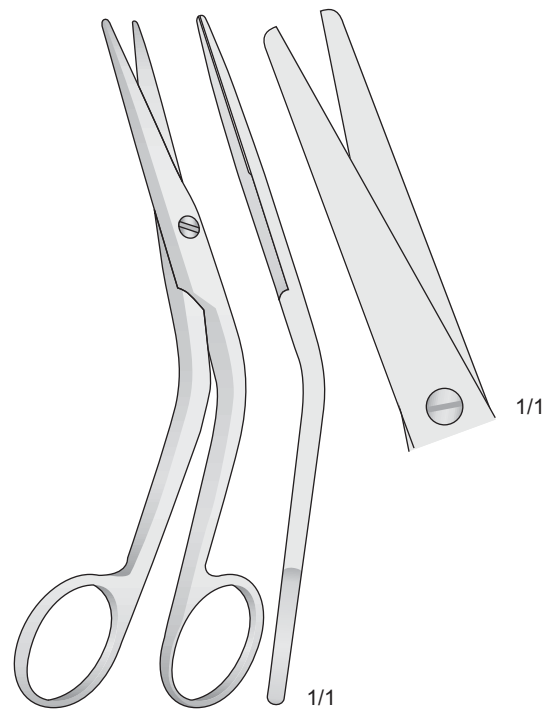

COTTLE
FG-9
160 mm

03

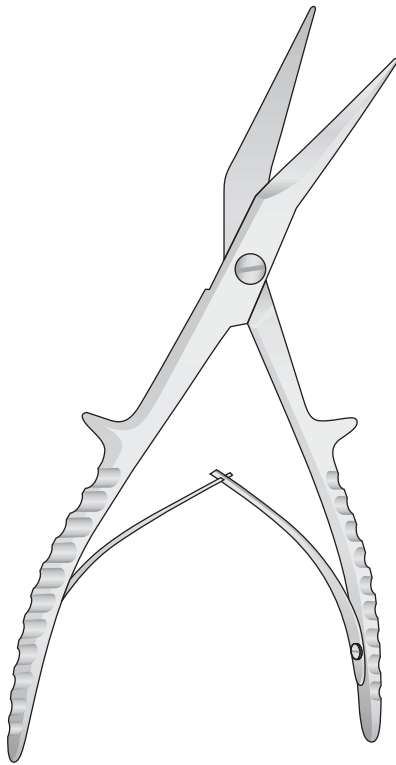

FG-110
195 mm

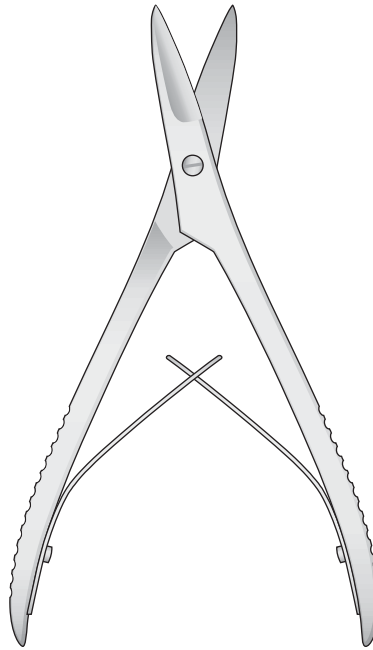

FO-63
160 mm

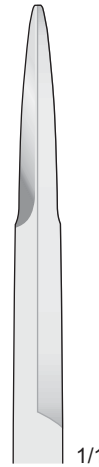

1/1

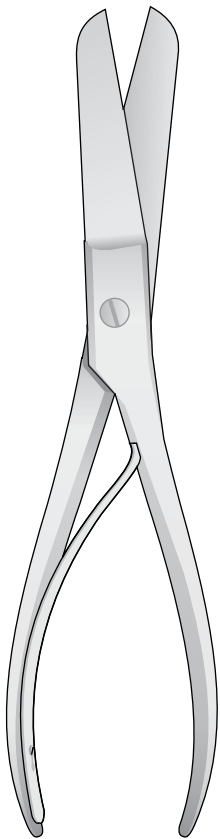

FG-40
230 mm

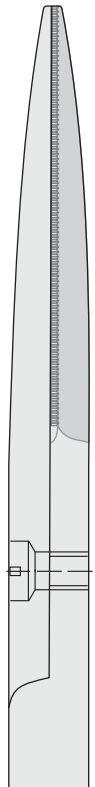

1/1

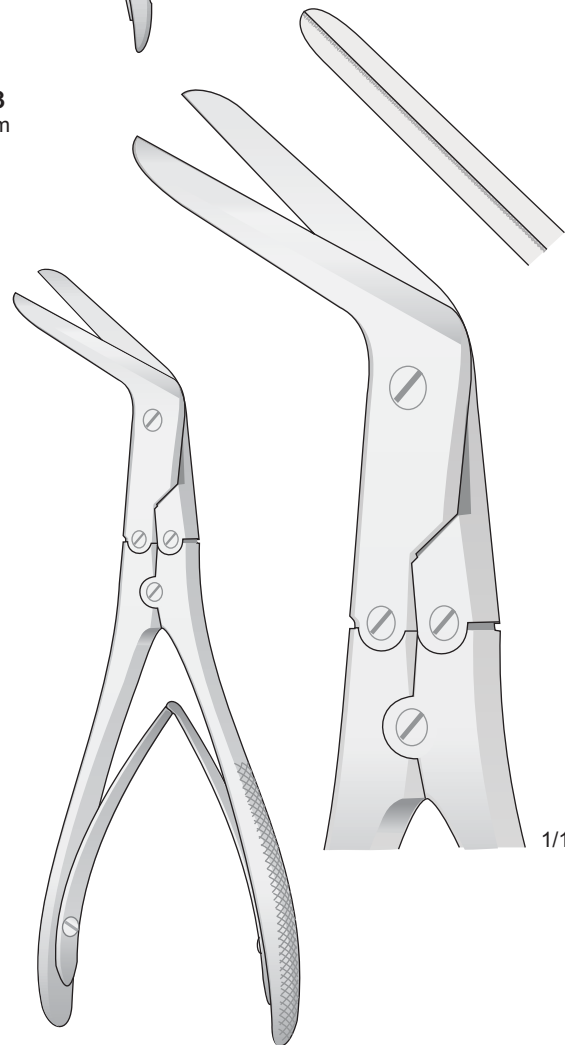

KILLIAN
FO-143
210 mm

1/1

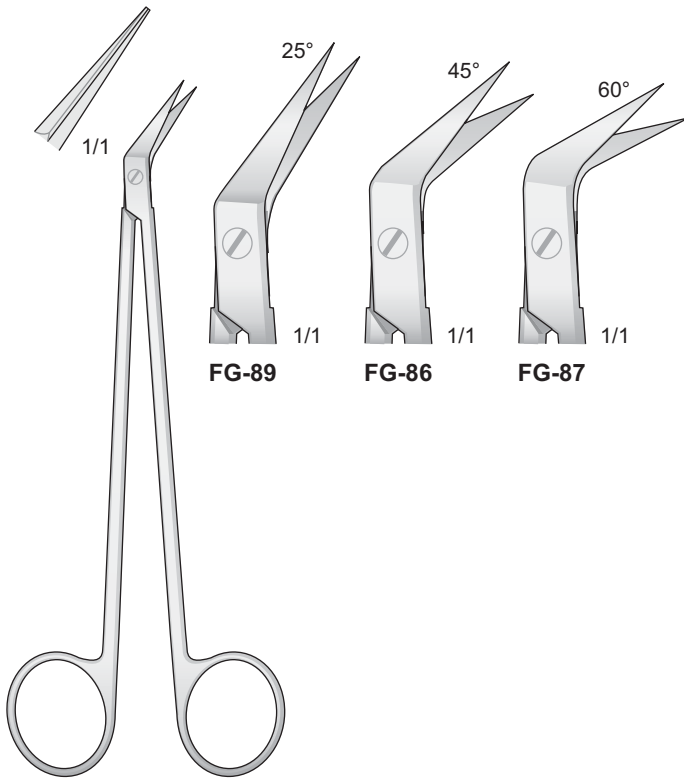

DE BAKEY (POTTS-SMITH)
FG-86/FG-89
160 mm

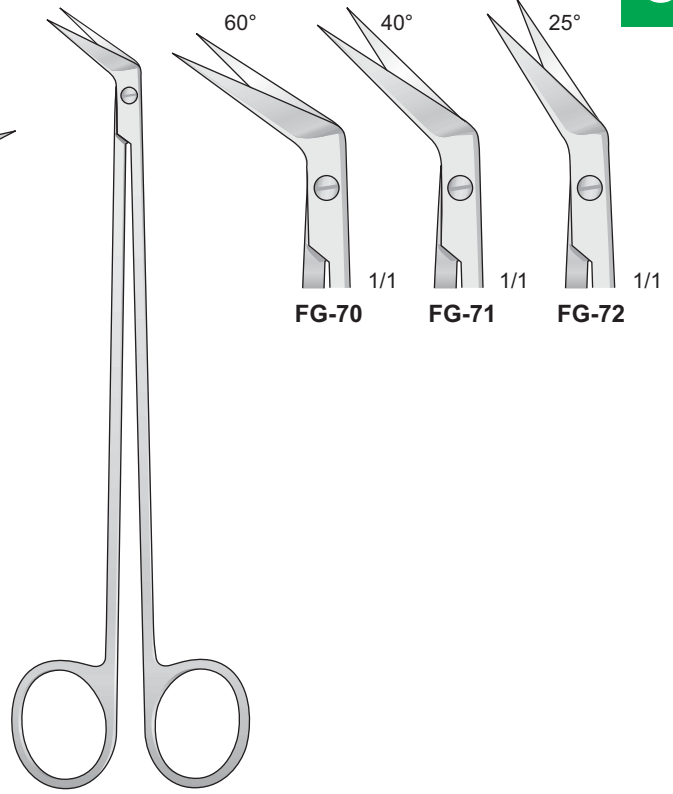

POTTS-SMITH
FG-70/FG-72
190 mm

Smussa - Blunt - Stumpf
Mousse - Romas

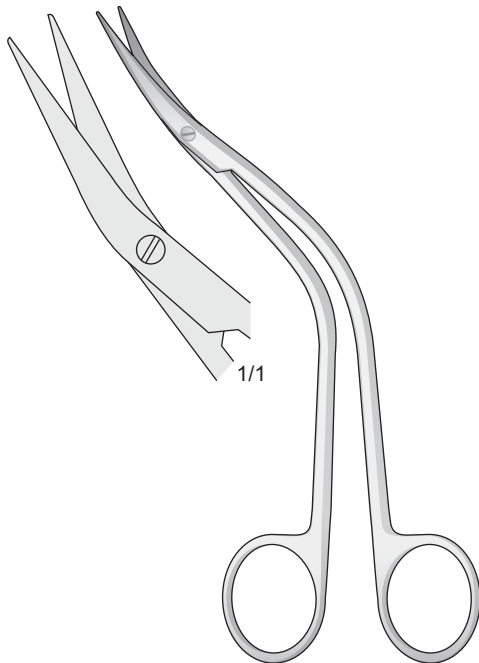

DE BAKEY
FG-78
155 mm

Acuta - Sharp - Spitz
Pointu - Agudas

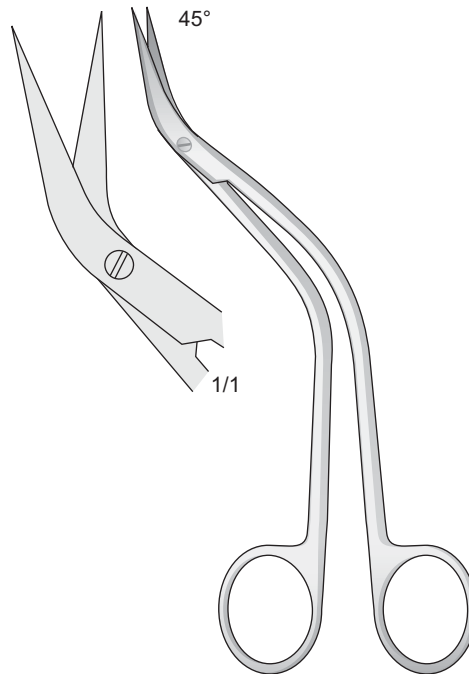

DE BAKEY
FG-79
155 mm

03

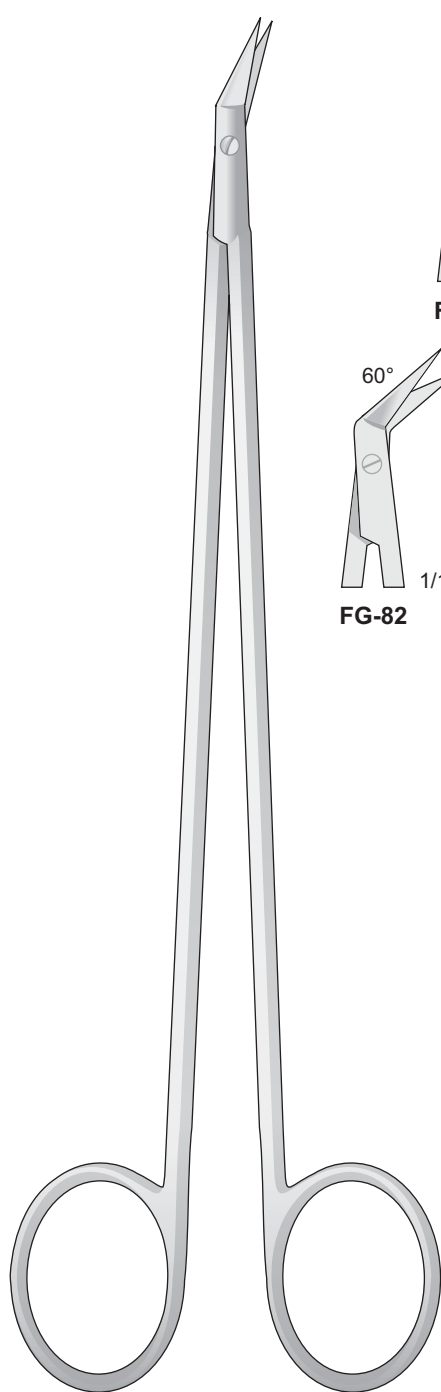

DIETRICH
FG-80/FG-84
190 mm

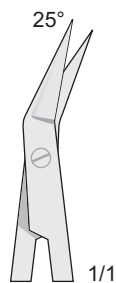

FG-80

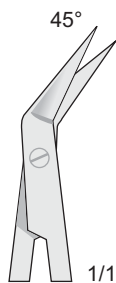

FG-81

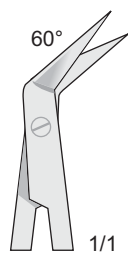

FG-82

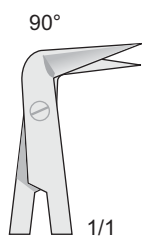

FG-83

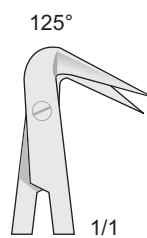

FG-84

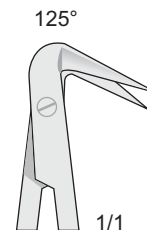

FG-85

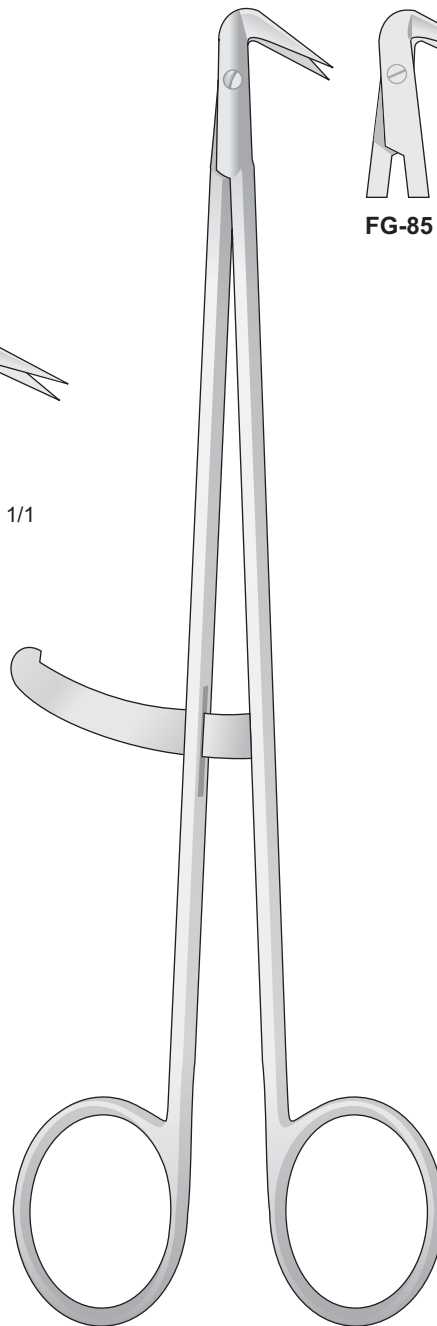

DIETRICH
FG-85
190 mm



MAYO-HARRINGTON
FM-18/FM-19
230 mm

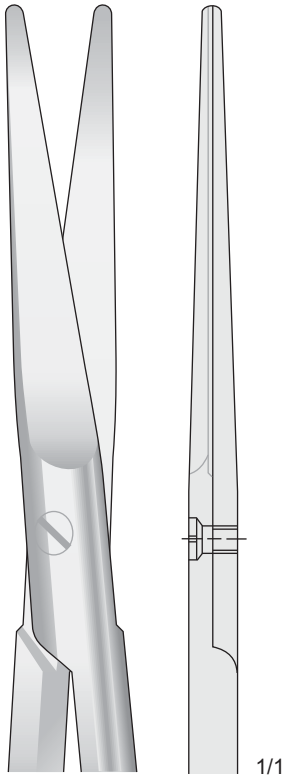

FM-18
230 mm

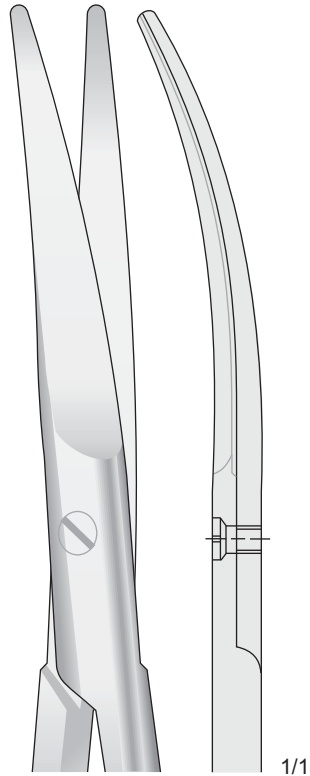

FM-19
230 mm

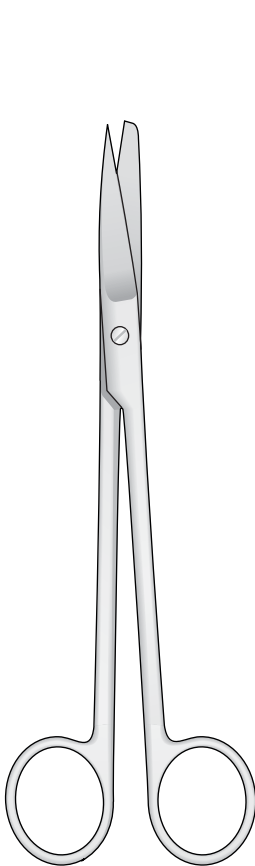

SIMS
FM-14/FM-17

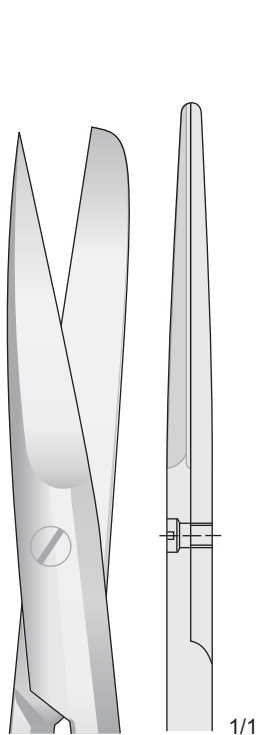

FM-14
200 mm

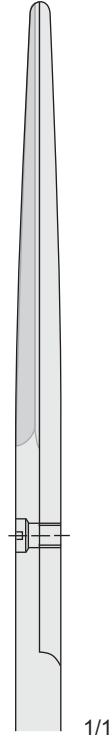

FM-16
230 mm

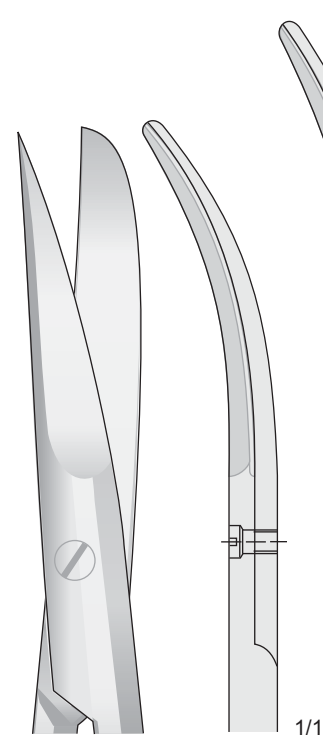

FM-15
200 mm

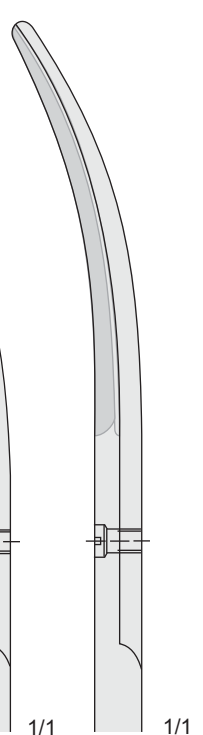

FM-17
230 mm

03



Punte smusse

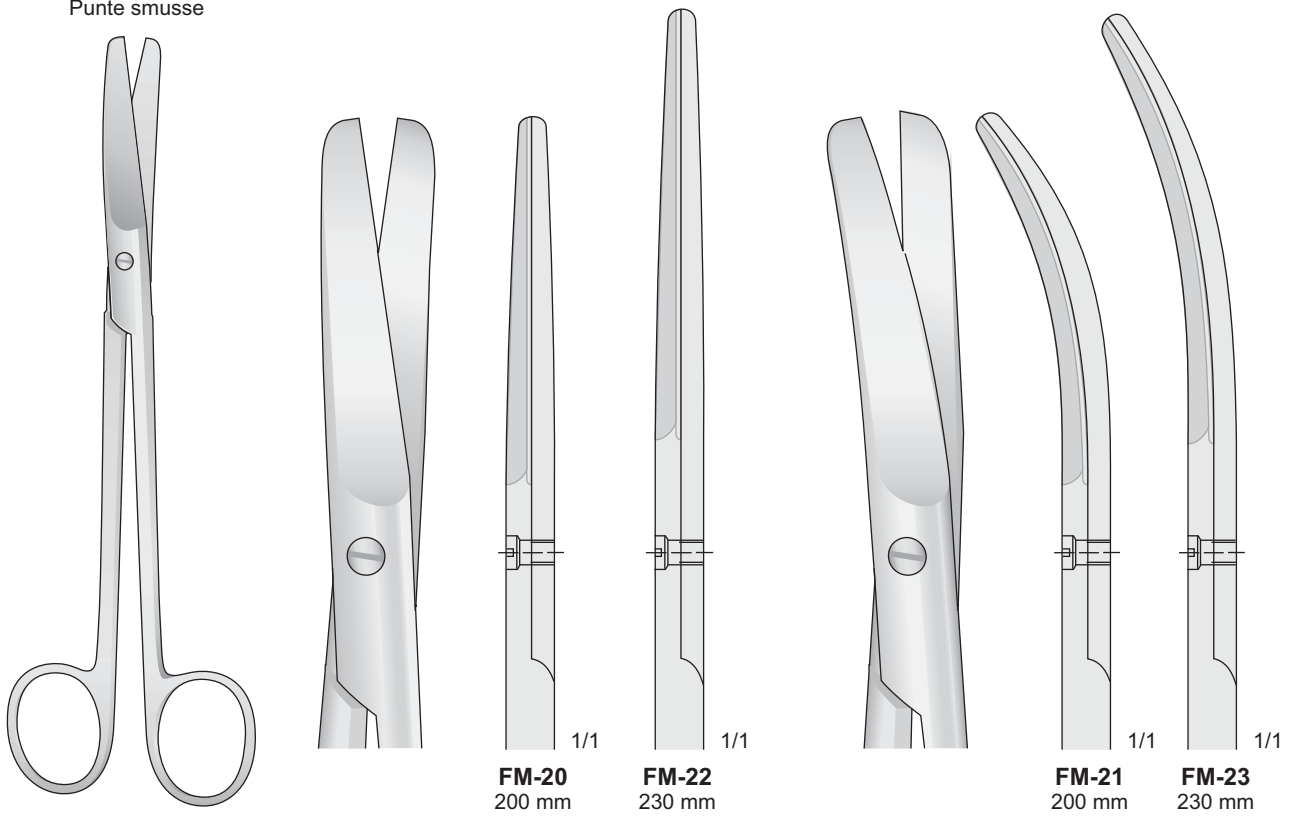

SIMS
FM-20/FM-23

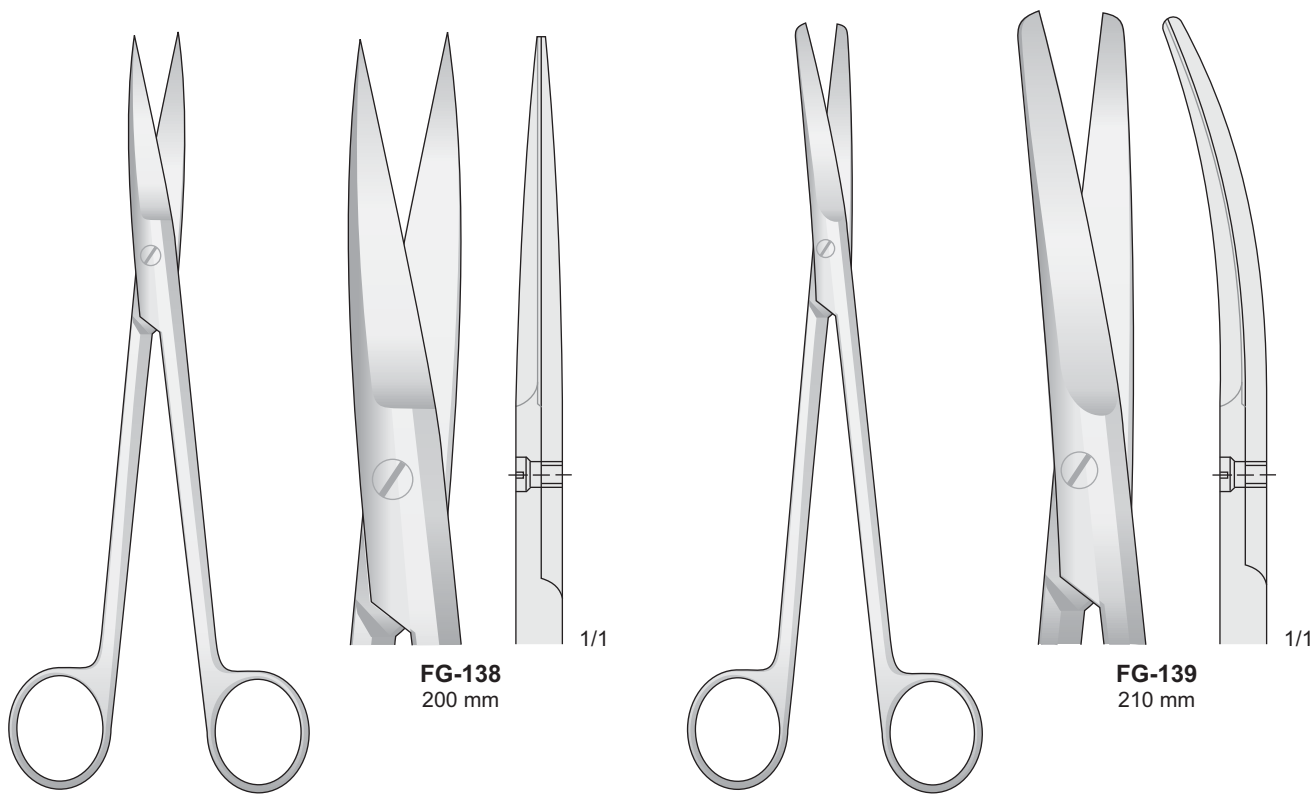

SIMS
FG-138
200 mm

SIMS
FG-139
210 mm

Forbici per episiotomia - Episotomy scissors
Episotomie-Scheren - Ciseaux à épisotomie
Tijeras para episiotomia

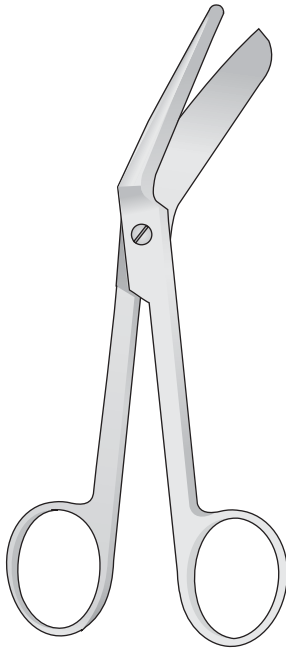

BRAUN-STADLER
FG-34/FG-96

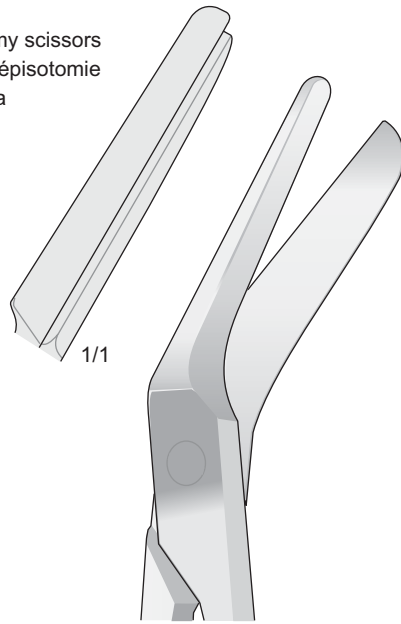

FG-34
145 mm

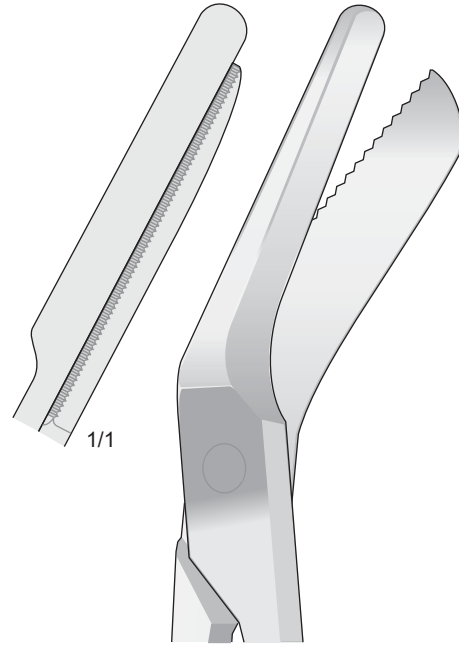

FG-96
200 mm

Forbici per cordone ombelicale - Umbilical cord scissors
Nabelschnur Scheren - Ciseaux à cordon ombilical
Tijeras umbilicales

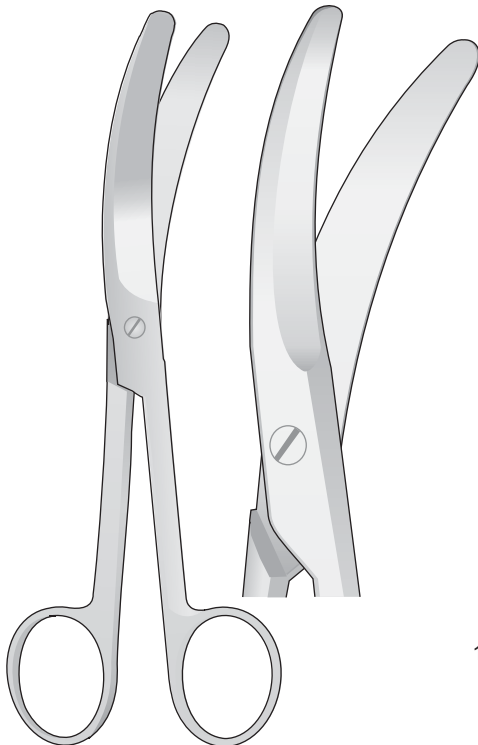

FG-35/FG-97

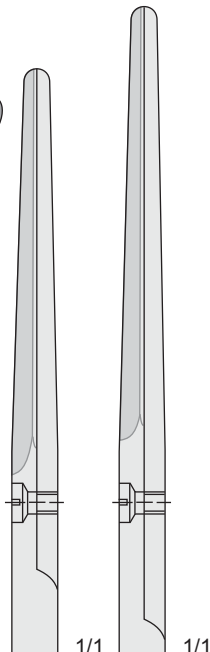

FG-97
135 mm

FG-35
160 mm



DUBOIS
FM-26/FM-175

Forbici per cefalotomia - Cephalotomy scissors
Kephilotomie Scheren - Ciseaux à céphalotomie
Tijeras para cefalotomia



FM-26
270 mm

FM-175
270 mm

03



Forbici per utero
 Uterine scissors
 Uterusschere
 Ciseaux utérins
 Tijeras para útero

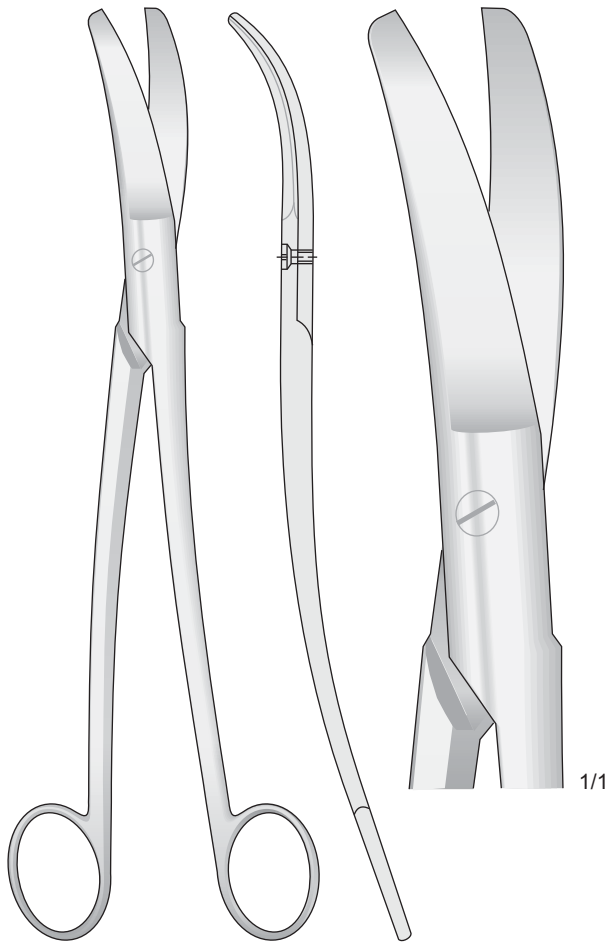

SIEBOLD
FG-144
 245 mm

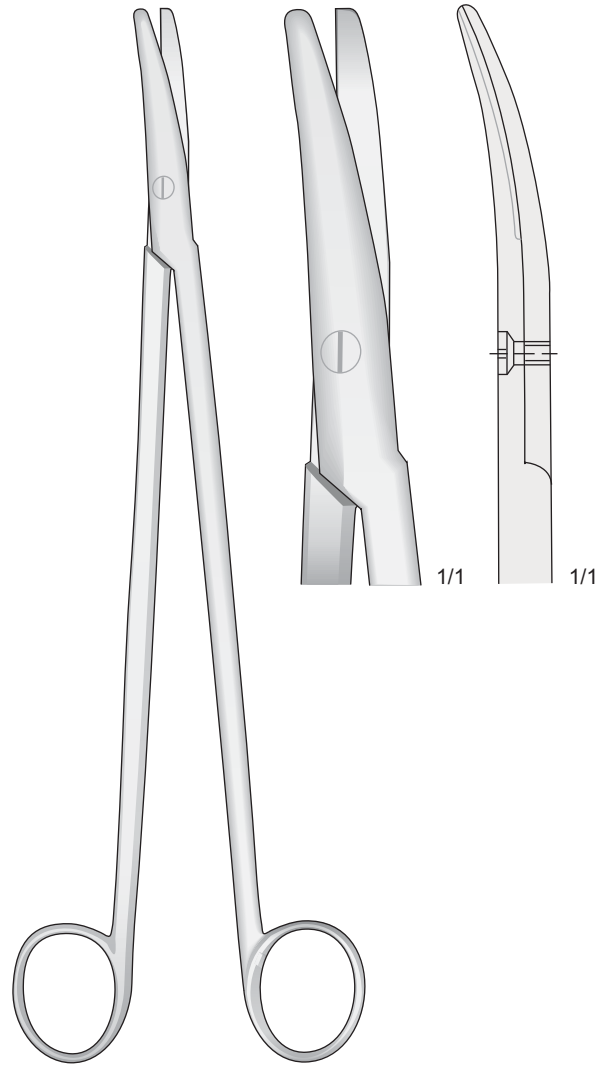

WELLER
FG-129
 280 mm

Forbici per Enterotomia
Bowel Scissors
Darmscheren
Ciseaux-Entérotomes
Enteròtomos

Forbici per Episiotomia
Episiotomy Scissors
Episiotomie-Scheren
Ciseaux à épisiotomie
Tijeras para Episiotomia

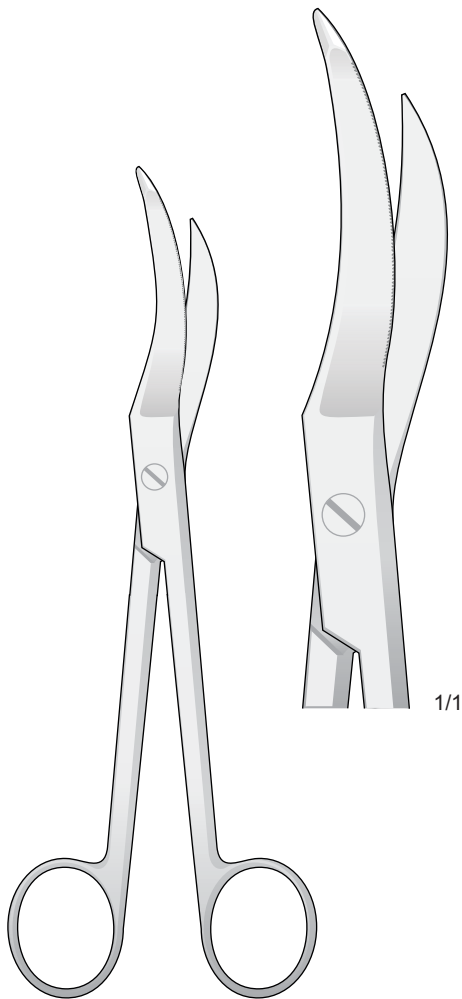

WALDMANN
FG-149
180 mm

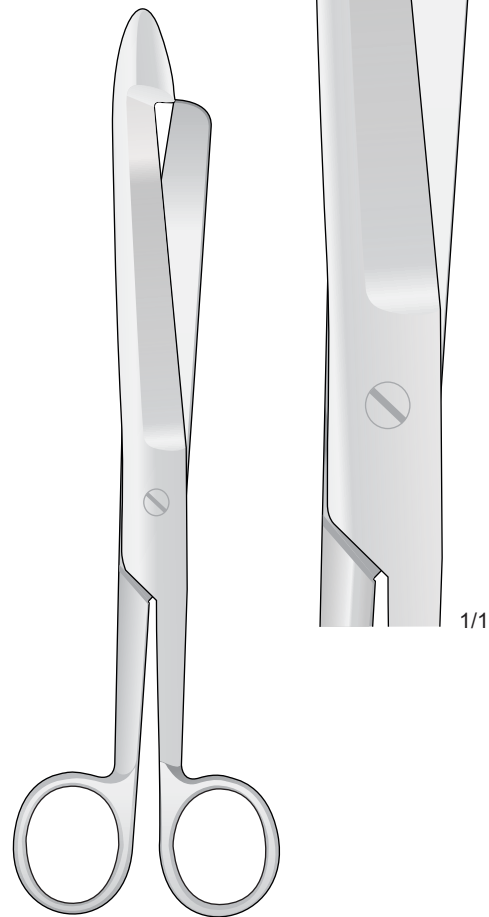

FG-180
210 mm

03



Forbici "super-cut" estremamente taglienti per tessuti con riduzi ne del trauma - "Super-cut" scissors for gripping tissue and cutting interproximally
 "Super-cut" scheren micro-schliff für tissue atrauma - Ciseaux "super cut" coupe les tissus en reduisant les risques de traumatisme
 Tijeras "super cortes" para cortar tissue-atrauma

Forbici Dentellate
 Scissors Serrateds
 Gezahnte Scheren
 Ciseaux Dentelé
 Tijeras Dentada

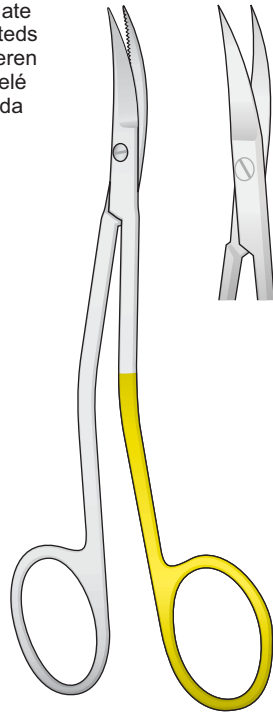

LA GRANGE
LG-1SC/LG-2SC
 115 mm



1/1

Acute
 Sharp
 Spitz
 Pointu
 Agudas

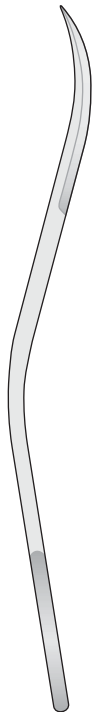

Smusse
 Blunt
 Stumpf
 Mousse
 Romas

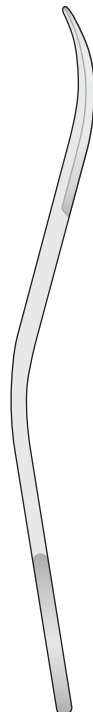

SUPER CUT

Regular Edge

SUPER CUT Edge

Super Cut Scissors have specially designed cutting edges. One regular edge and **one sharp-knife edge.**

Extremely Sharp Razor Edge / Atraumatic
 Extrem Scharfe Spitzer Beck / Atraumatische
 Tranchant extrêmement aiguisée / Atraumatique
 Borde extremadamente afilado / Atraumática
 Taglio estremamente affilato / Atraumatica

One side serrated
 Eine seite gezahnt
 Un côté dentelé
 Un lado dentado
 Un lato dentellato

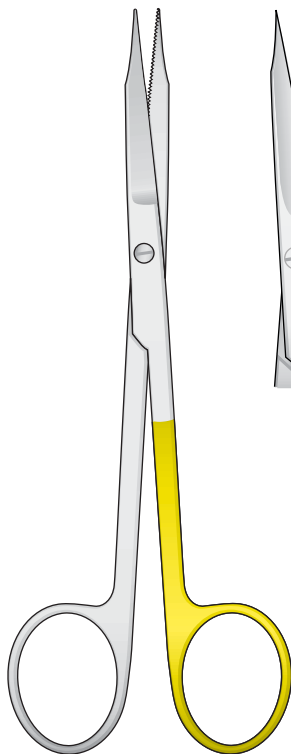

GOLDMAN-FOX
GFR-SC/GFC-SC
 135 mm



1/1

GFR-SC

1/1

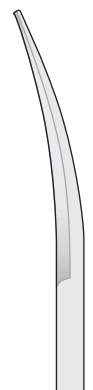

1/1

GFC-SC

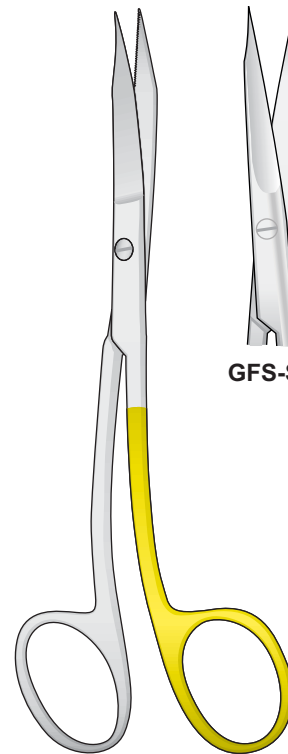

GOLDMAN-FOX S FORM
GFS-SC
 130 mm



1/1

GFS-SC

Forbici "super-cut" estremamente taglienti per tessuti con riduzi ne del trauma - "Super-cut" scissors for gripping tissue and cutting interproximally
 "Super-cut" scheren micro-schliff für tissue atrauma - Ciseaux "super cut" coupe les tissus en réduisant les risques de traumatisme
 Tijeras "super cortes" para cortar tissute-atrauma

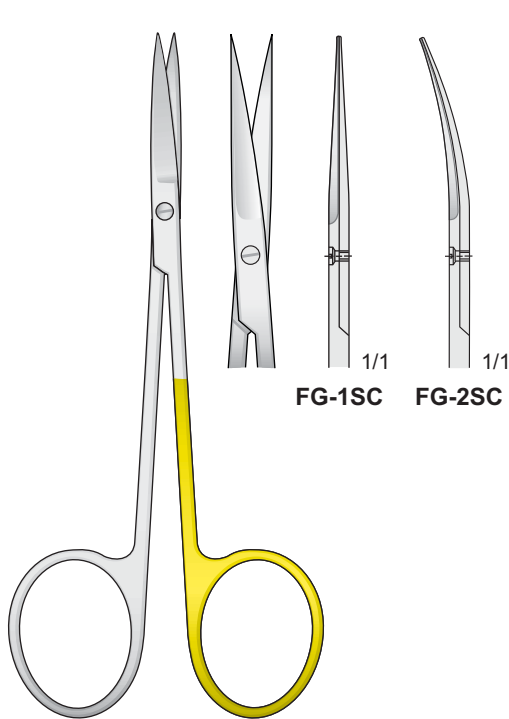

IRIS
FG-1SC/FG-2SC
 110 mm

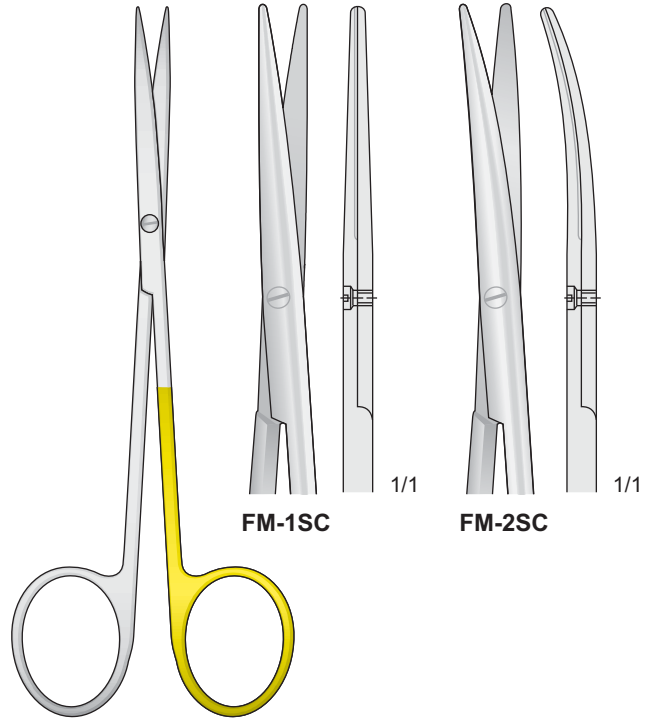

METZENBAUM
FM-1SC/FM-2SC
 145 mm

SUPER CUT

Regular Edge **SUPER CUT Edge**

Super Cut Scissors have specially designed cutting edges.
 One regular edge and **one sharp-knife edge.**

Extremely Sharp Razor Edge / Atraumatic
 Extrem Scharfe Spitzer Beck / Atraumatische
 Tranchant extrêmement aiguisée / Atraumatique
 Borde extremadamente afilado / Atraumática
 Taglio estremamente affilato / Atraumatica

One side serrated
 Eine seite gezahnt
 Un côté dentelé
 Un lado dentado
 Un lato dentellato

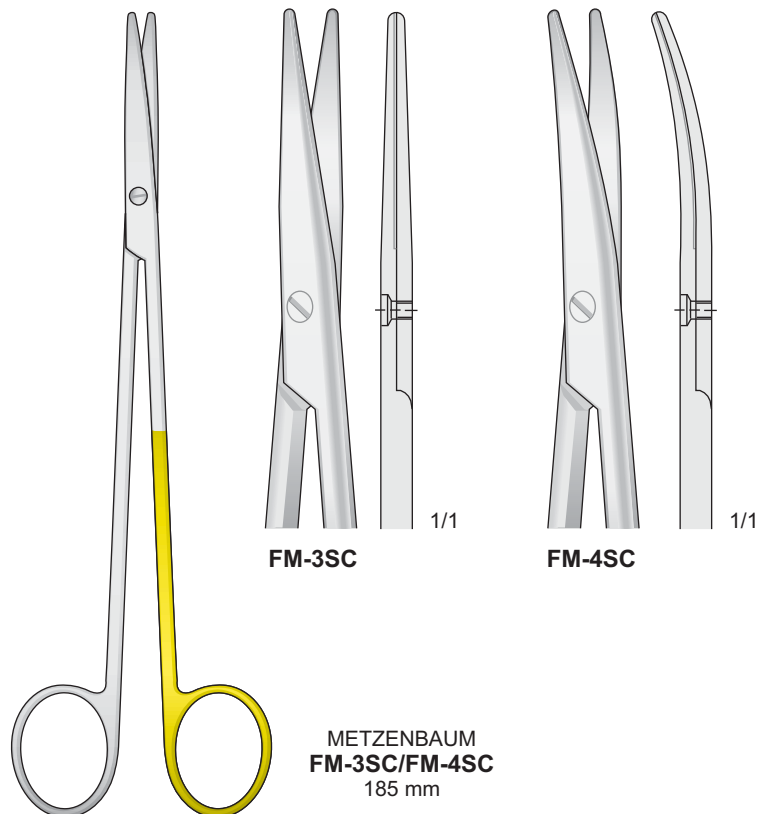

METZENBAUM
FM-3SC/FM-4SC
 185 mm

Forbici "super-cut" estremamente taglienti per tessuti con riduzi ne del trauma - "Super-cut" scissors for gripping tissue and cutting interproximally
 "Super-cut" scheren micro-schliff für tissue atrauma - Ciseaux "super cut" coupe les tissus en reduisant les risques de traumatisme
 Tijeras "super cortes" para cortar tissue-atrauma

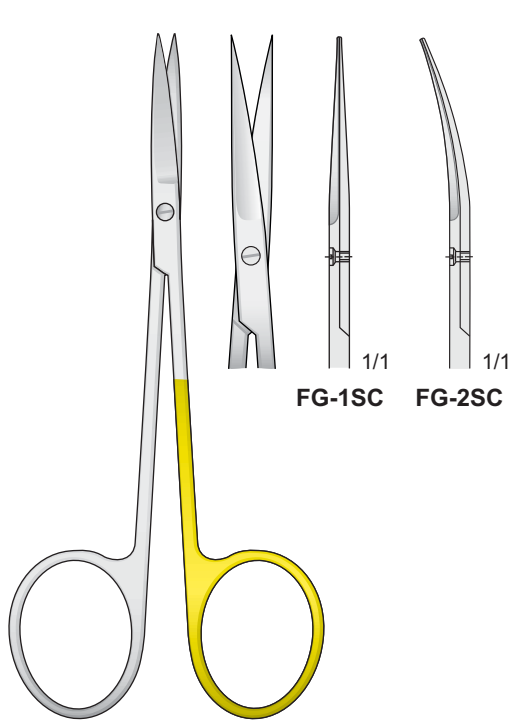

IRIS
FG-1SC/FG-2SC
 110 mm

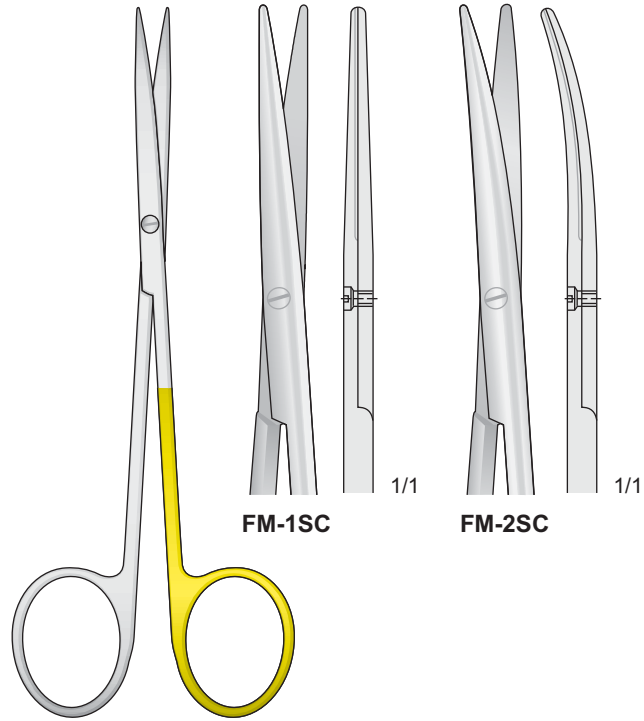

METZENBAUM
FM-1SC/FM-2SC
 145 mm

SUPER CUT

Regular Edge **SUPER CUT Edge**

Super Cut Scissors have specially designed cutting edges.
 One regular edge and **one sharp-knife edge.**

Extremely Sharp Razor Edge / Atraumatic
 Extrem Scharfe Spitzer Beck / Atraumatische
 Tranchant extrêmement aiguisée / Atraumatique
 Borde extremadamente afilado / Atraumática
 Taglio estremamente affilato / Atraumatica

ONE SIDE SERRATED
 Eine seite gezahnt
 Un côté dentelé
 Un lado dentado
 Un lato dentellato

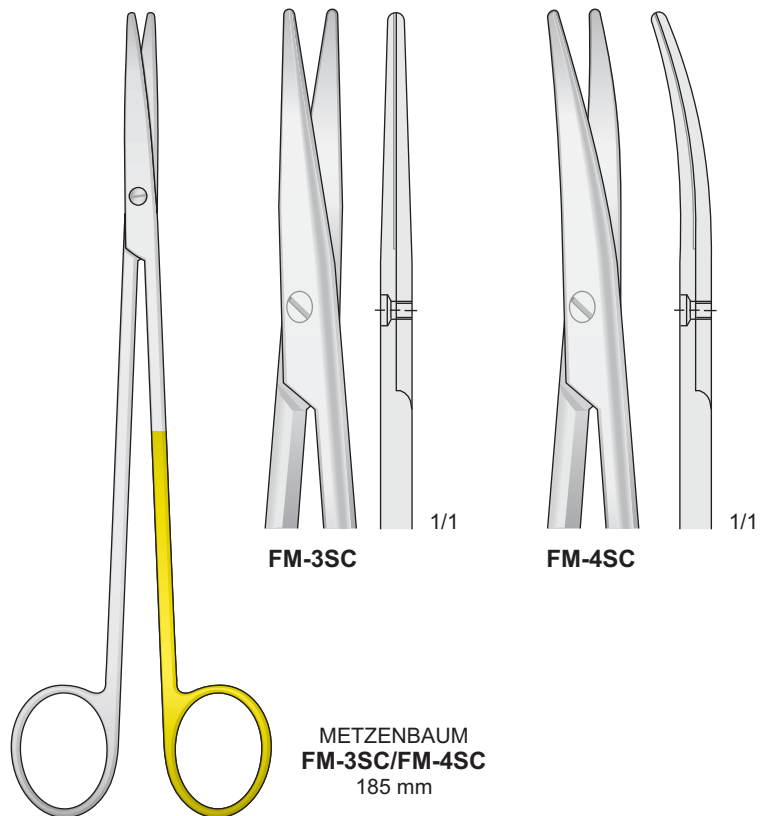

METZENBAUM
FM-3SC/FM-4SC
 185 mm

Forbici "super-cut" estremamente taglienti per tessuti con riduzi ne del trauma - "Super-cut" scissors for gripping tissue and cutting interproximally
 "Super-cut" scheren micro-schliff für tissue atrauma - Ciseaux "super cut" coupe les tissus en réduisant les risques de traumatisme
 Tijeras "super cortes" para cortar tissute-atrauma

SUPER CUT

Regular Edge **SUPER CUT Edge**

Super Cut Scissors have specially designed cutting edges.
 One regular edge and **one sharp-knife edge.**

Extremely Sharp Razor Edge / Atraumatic
 Extrem Scharfe Spitzer Beck / Atraumatische
 Tranchant extrêmement aiguisée / Atraumatique
 Borde extremadamente afilado / Atraumática
 Taglio estremamente affilato / Atraumatica

ONE SIDE SERRATED
 Eine seite gezahnt
 Un côté dentelé
 Un lado dentado
 Un lato dentellato

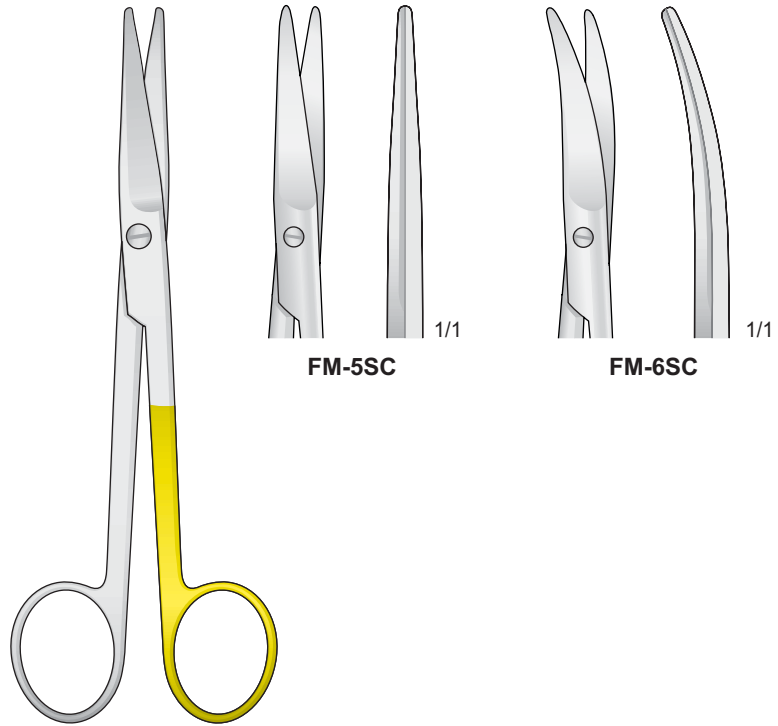

MAYO
FM-5SC/FM-6SC
 140 mm

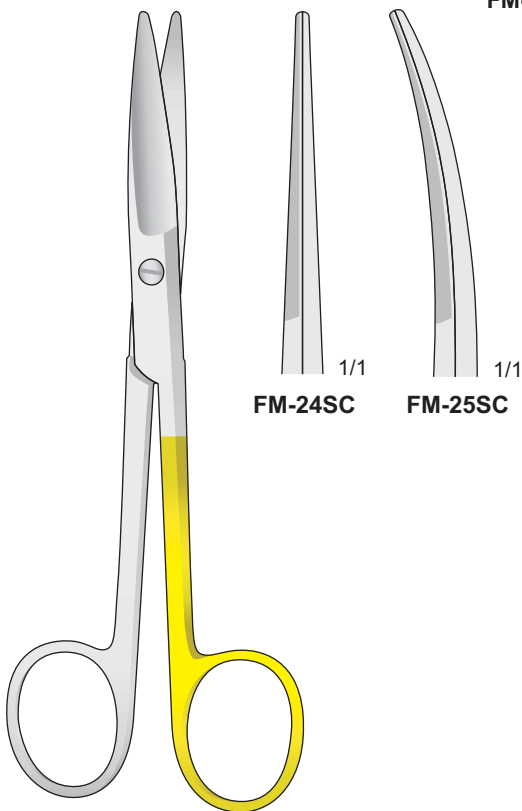

MAYO
FM-24SC/FM25SC
 170 mm

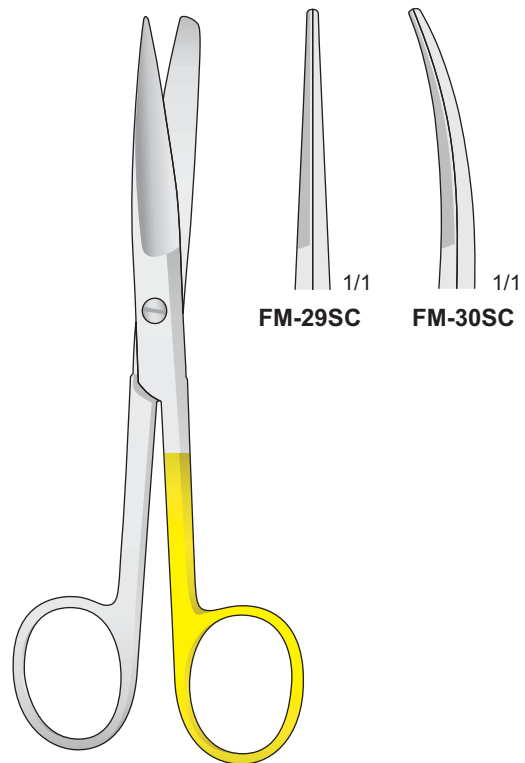

FM-29SC/FM30SC
 145 mm

03



L = mancini
left
links
gauche
iequierdo

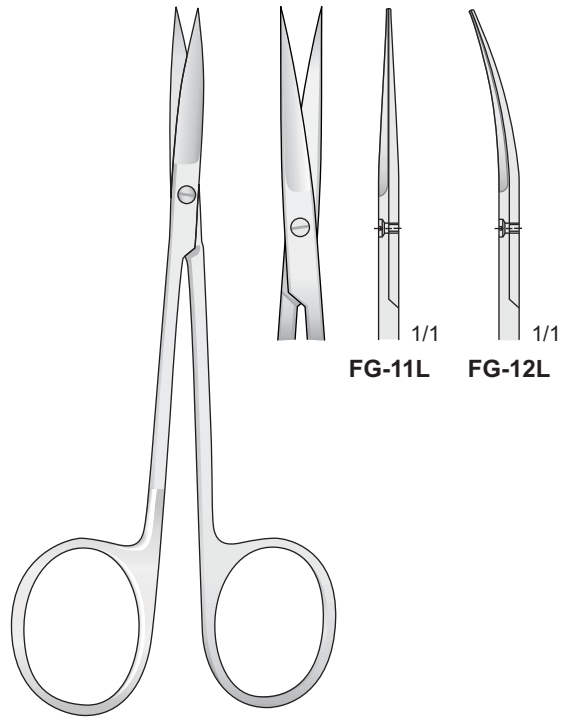

IRIS
FG-11L/FG-12L
110 mm

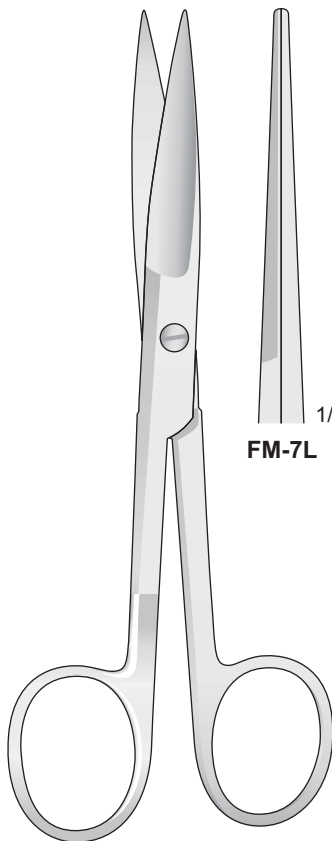

FM-7L/FM-8L
145 mm

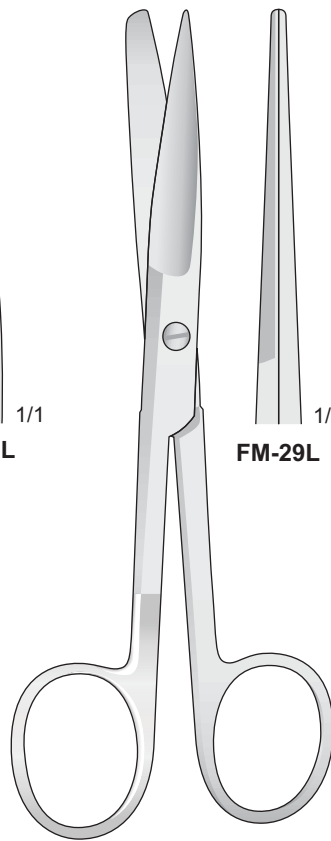

FM-29L/FM-30L
145 mm

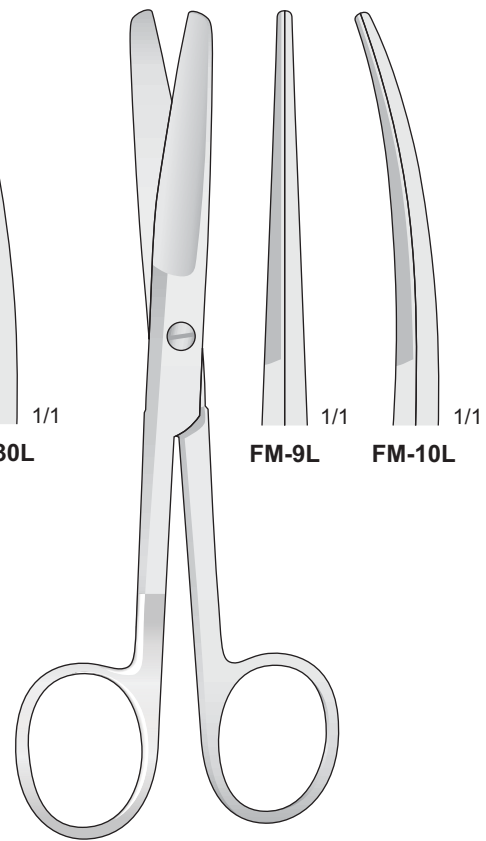

FM-9L/FM-10L
145 mm

Con punta al carburo di tungsteno - Tungsten-carbide scissors
Mit Hartmetalleinsätzen - Avec plaquettes en carbure de tungstène - Tijeras de tungsteno



IRIS
FG1-TC/FG2-TC
115 mm

TC
TUNGSTEN
CARBIDE

Tungsten-Carbide Inserts
Mit Hartmetalleinsätzen
Plaquettes en carbure de tungstène
Plaquetas de carburo de tungsteno
Inserti in carburo di tungsteno

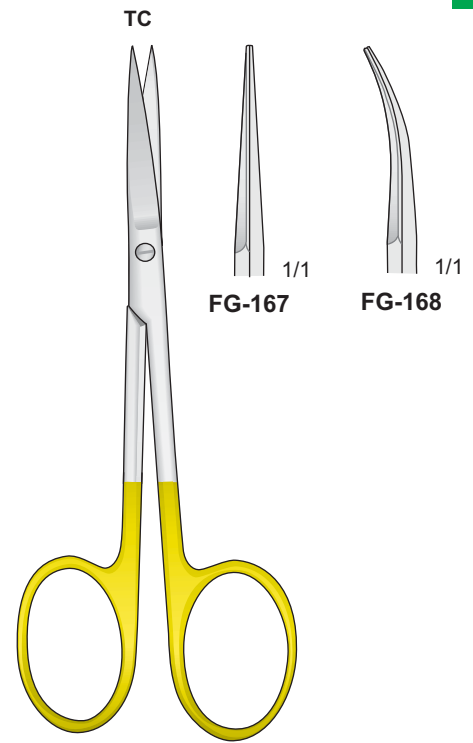

FG-167/FG-168
110 mm

Dentellata
Serrated
Gezahnt
Dentée
Dentadas

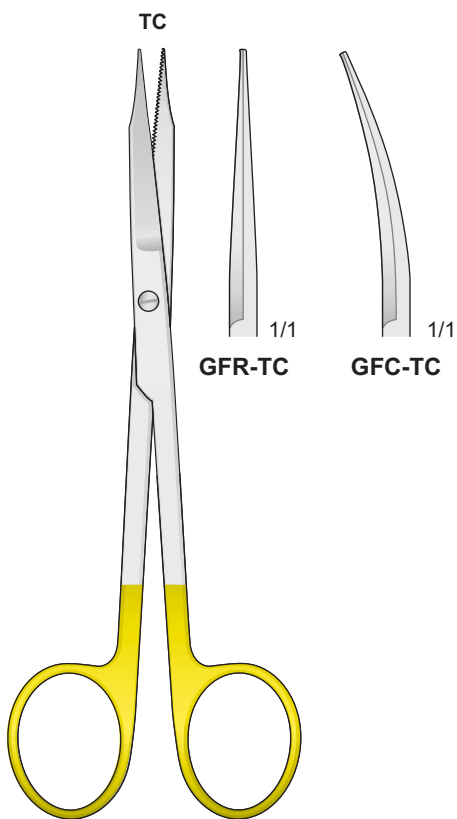

GOLDMAN-FOX
GFR-TC/GFC-TC
135 mm

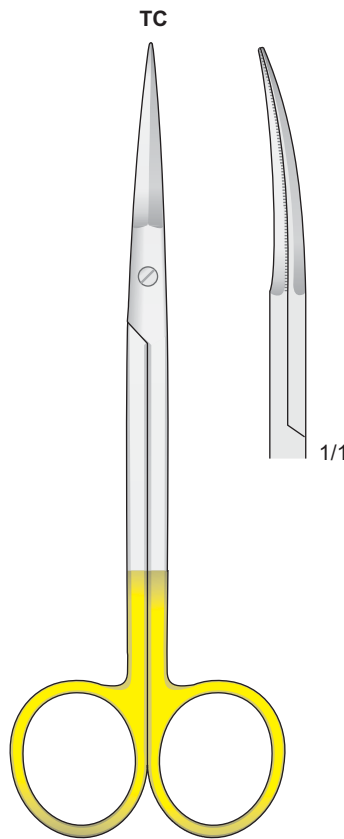

PECK-JOSEPH
FG-92
140 mm

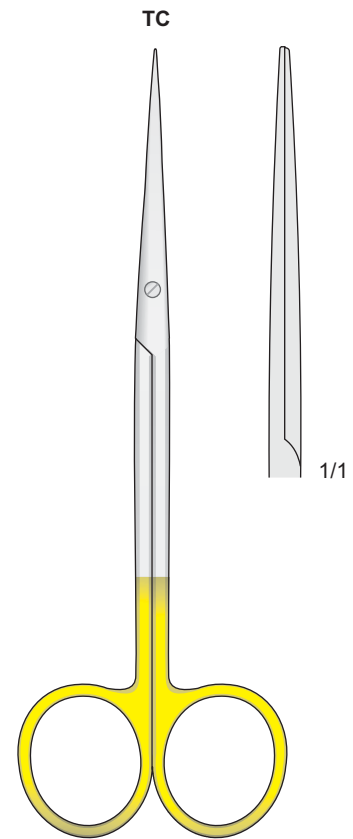

METZENBAUM-FINO
FM-96
140 mm

Con punta al carburo di tungsteno - Tungsten-carbide scissors
 Mit Hartmetalleinsätzen - Avec plaquettes en carbure de tungstène - Tijeras de tungsteno

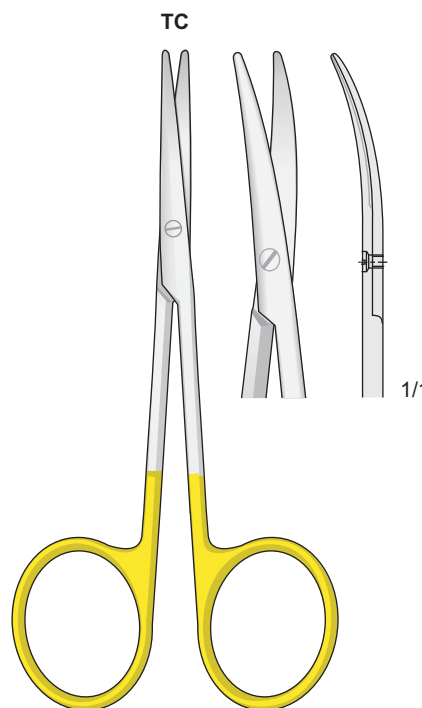
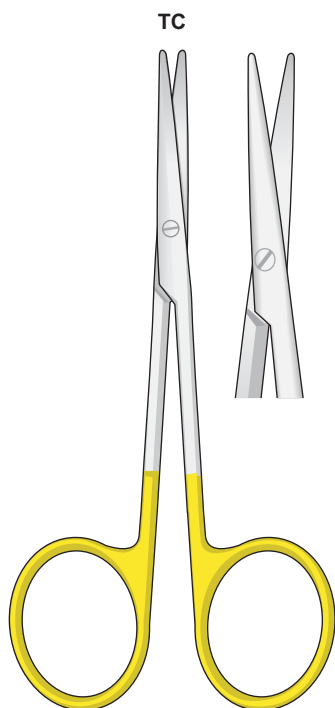

FM-118
115 mm

FM-119
115 mm

TC
TUNGSTEN
CARBIDE

Tungsten-Carbide Inserts
 Mit Hartmetalleinsätzen
 Plaquettes en carbure de tungstène
 Plaquetas de carburo de tungsteno
 Inserti in carburo di tungsteno

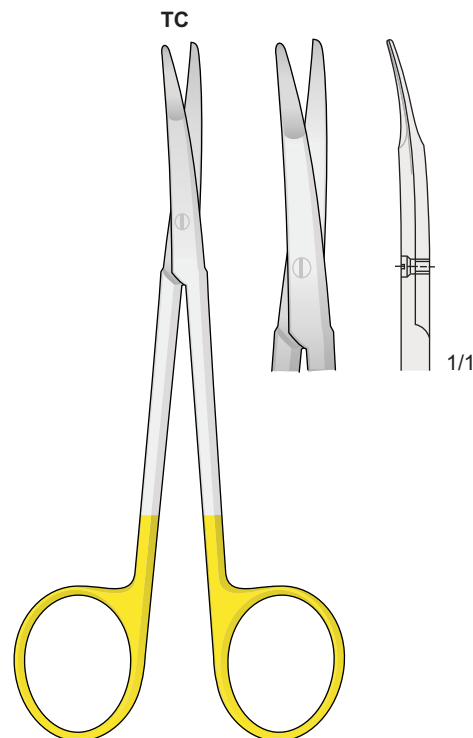
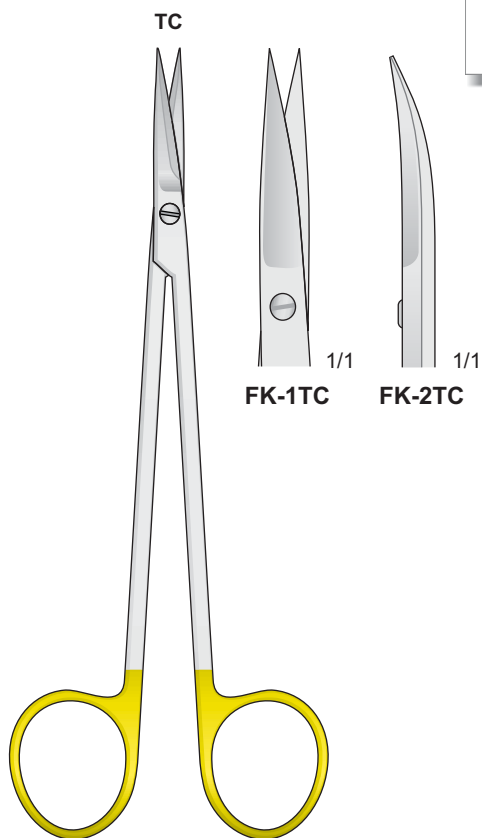

KELLY
FK-1TC/FK-2TC
160 mm

KILNER (RAGNELL)
FM-350
125 mm

Con punta al carburo di tungsteno - Tungsten-carbide scissors
Mit Hartmetalleinsätzen - Avec plaquettes en carbure de tungstène - Tijeras de tungsteno

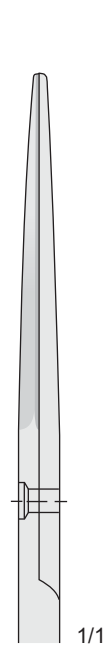
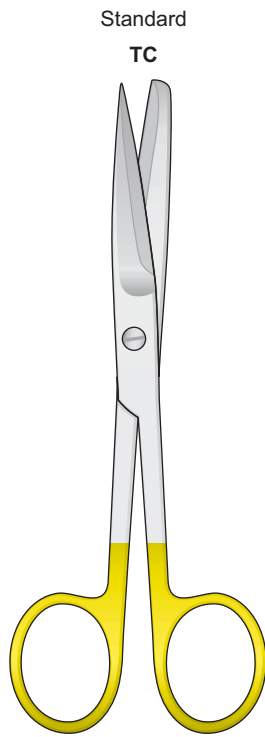

FM-50
130 mm

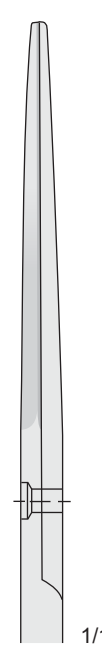

FM-51
145 mm

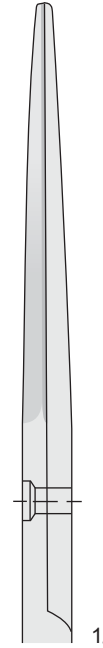

FM-52
165 mm

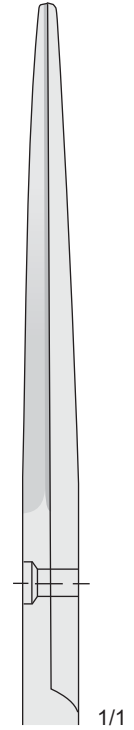

FM-53
185 mm

FM-50/FM-53



Tungsten-Carbide Inserts
Mit Hartmetalleinsätzen
Plaquettes en carbure de tungstène
Plaquetas de carburo de tungsteno
Inserti in carburo di tungsteno

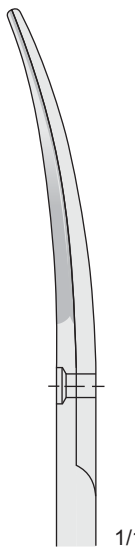
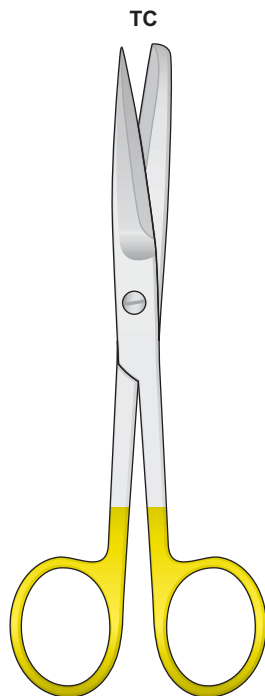

FM-148
130 mm

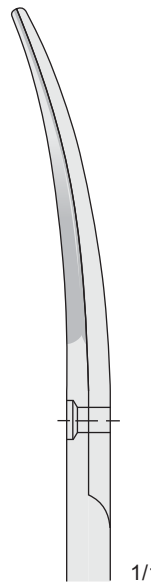

FM-149
145 mm

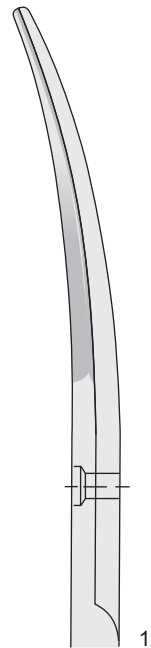

FM-150
165 mm

FM-148/FM-150

03



Con punta al carburo di tungsteno - Tungsten-carbide scissors
 Mit Hartmetalleinsätzen - Avec plaquettes en carbure de tungstène - Tijeras de tungsteno

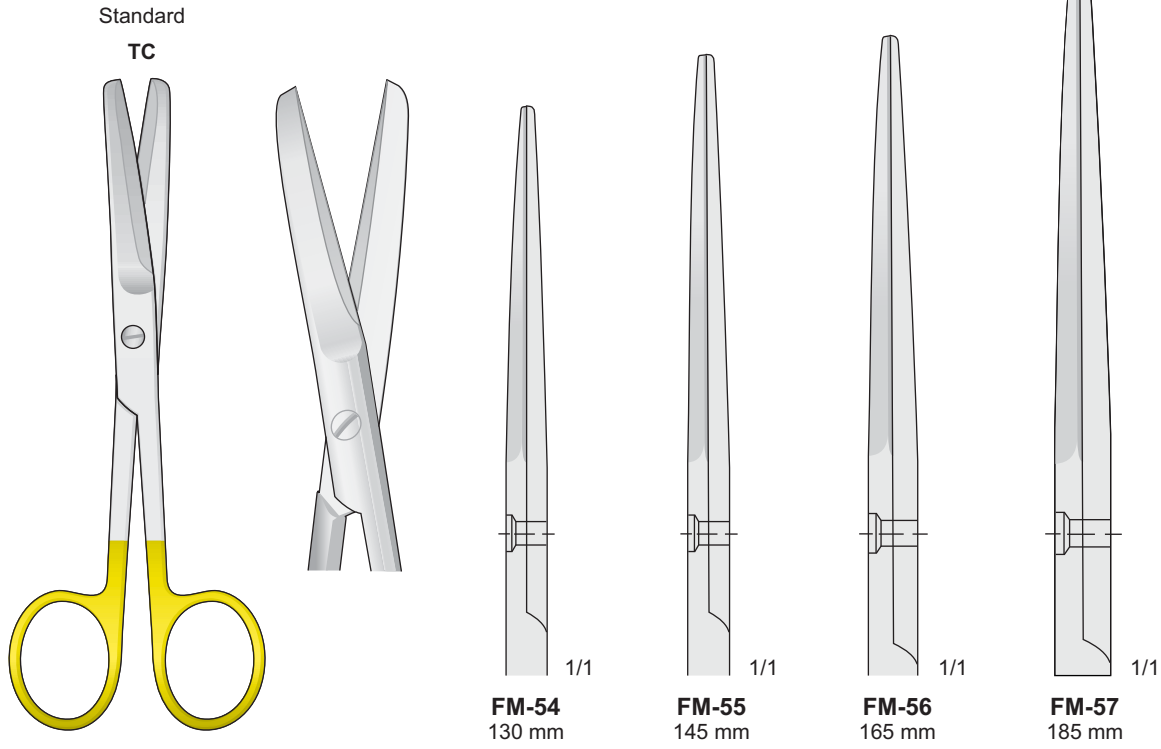

FM-54/FM-57



FM-151/FM-153

Con punta al carburo di tungsteno - Tungsten-carbide scissors
Mit Hartmetalleinsätzen - Avec plaquettes en carbure de tungstène - Tijeras de tungsteno

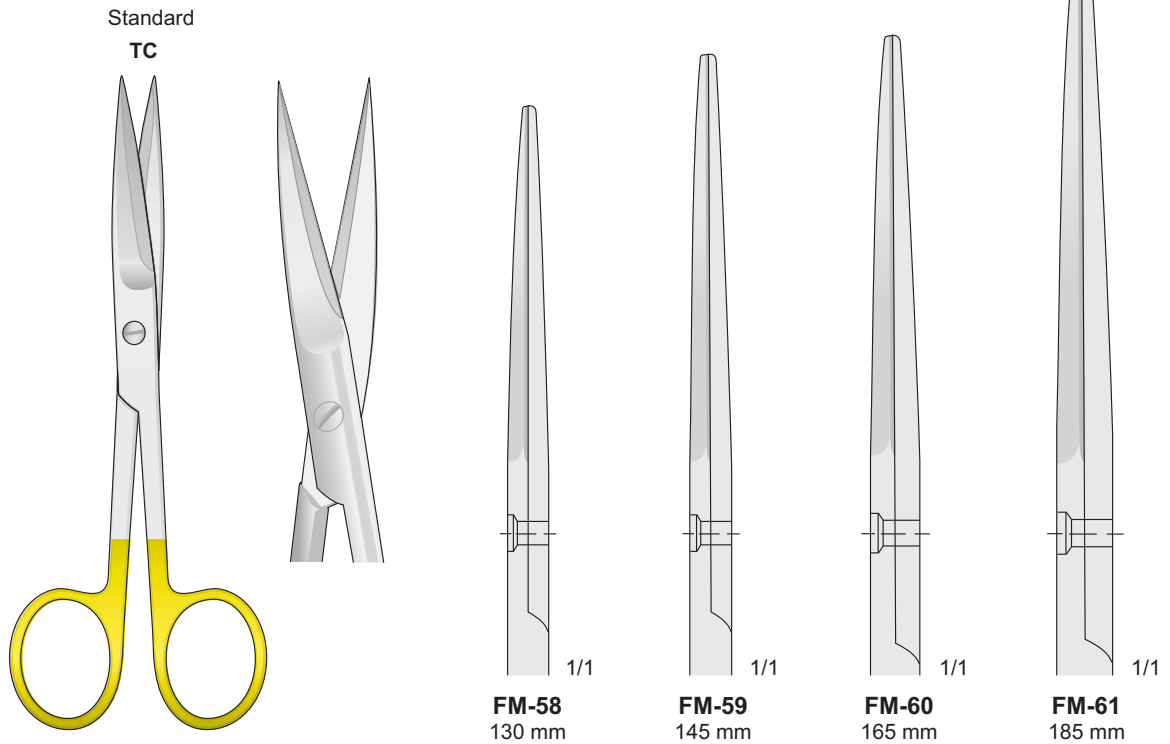

FM-58/FM-61



Tungsten-Carbide Inserts
Mit Hartmetalleinsätzen
Plaquettes en carbure de tungstène
Plaquetas de carburo de tungsteno
Inserti in carburo di tungsteno



FM-145/FM-147

Con punta al carburo di tungsteno - Tungsten-carbide scissors
 Mit Hartmetalleinsätzen - Avec plaquettes en carbure de tungstène - Tijeras de tungsteno

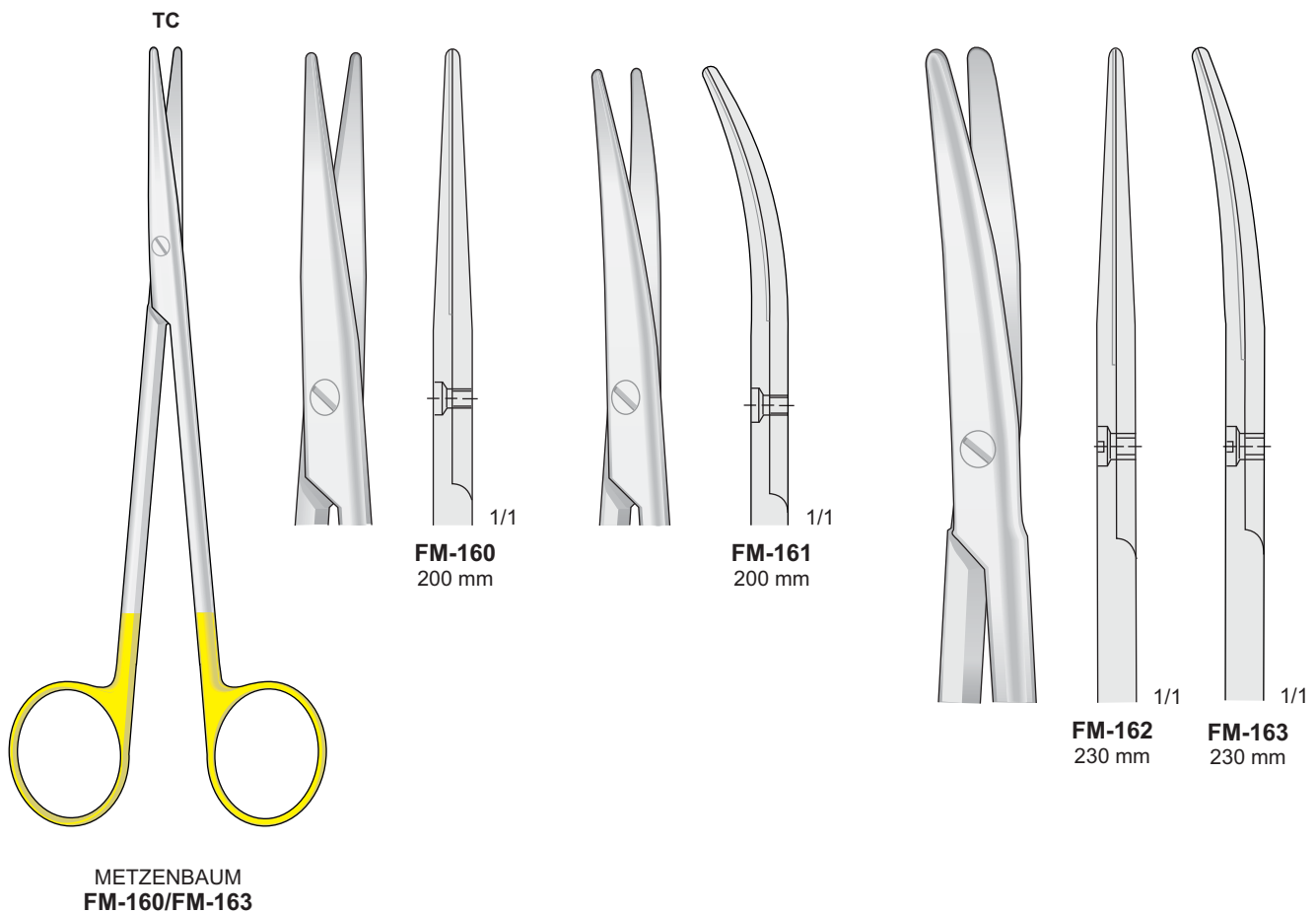
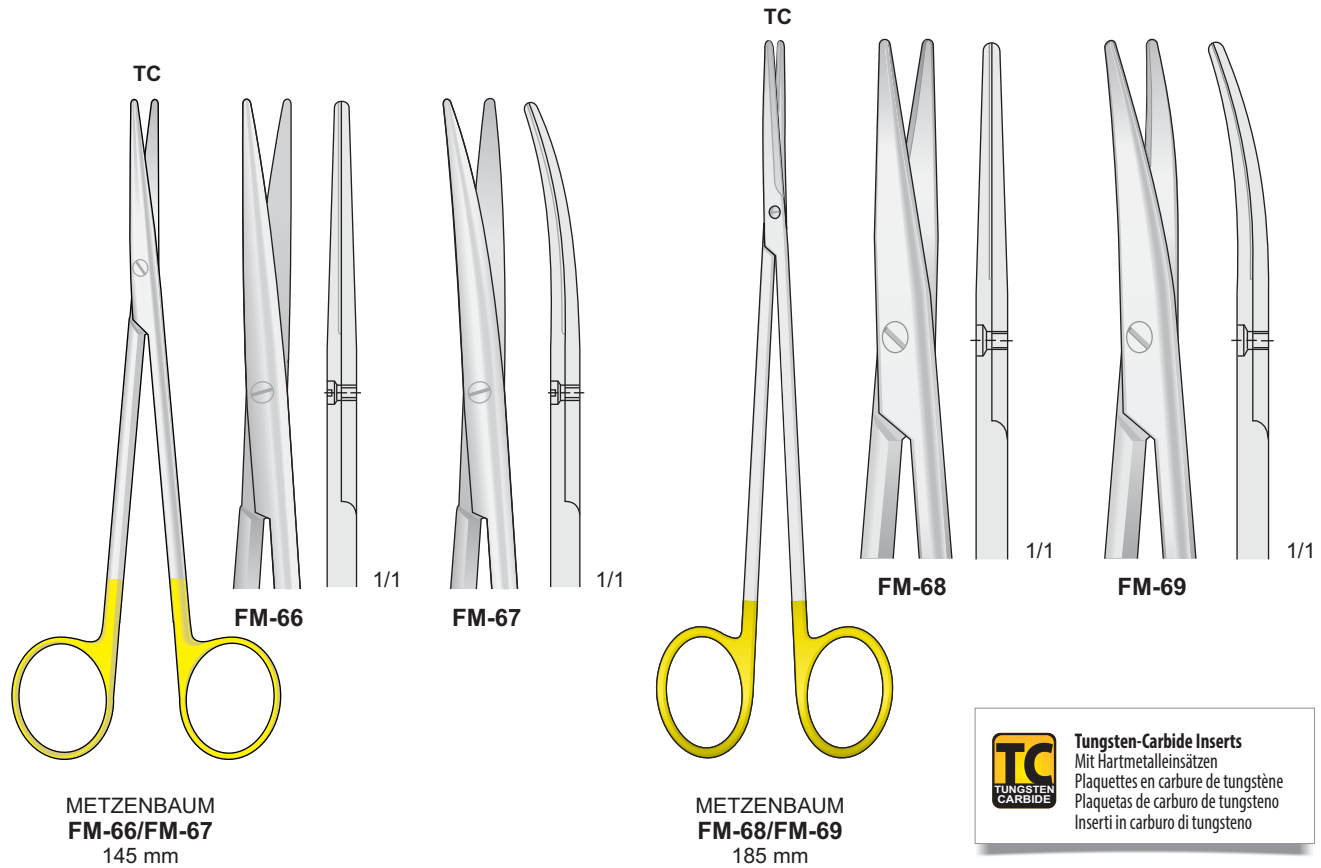

Con punta al carburo di tungsteno - Tungsten-carbide scissors
Mit Hartmetalleinsätzen - Avec plaquettes en carbure de tungstène - Tijeras de tungsteno

TC

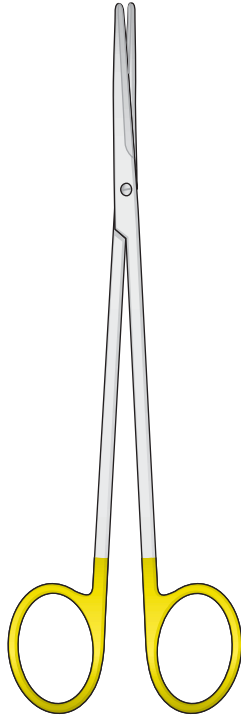

METZENBAUM-FINO
FM-201/FM-205

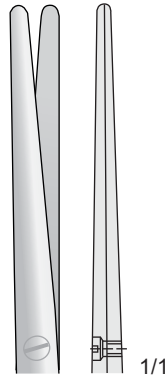

FM-201
140 mm

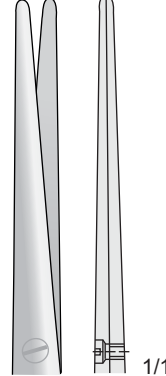

FM-203
180 mm

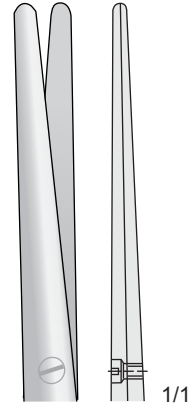

FM-205
200 mm



Tungsten-Carbide Inserts
Mit Hartmetalleinsätzen
Plaquettes en carbure de tungstène
Plaquetas de carburo de tungsteno
Inserti in carburo di tungsteno

TC

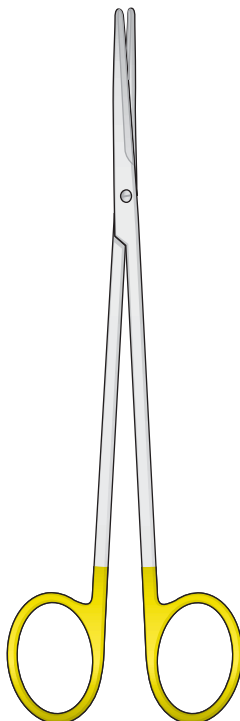

METZENBAUM-FINO
FM-207/FM-211

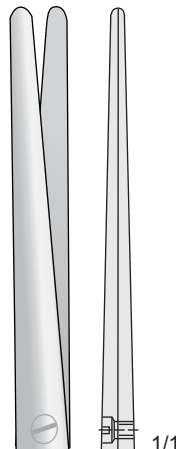

FM-207
230 mm

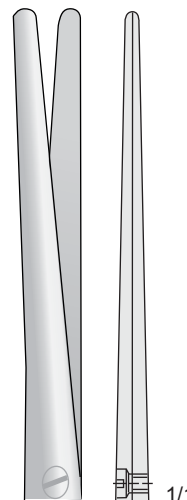

FM-209
250 mm

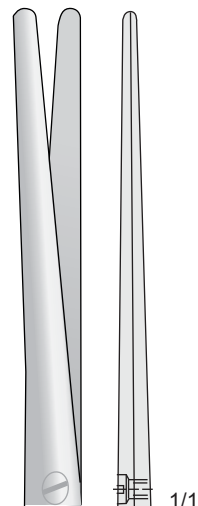

FM-211
280 mm

Con punta al carburo di tungsteno - Tungsten-carbide scissors
 Mit Hartmetalleinsätzen - Avec plaquettes en carbure de tungstène - Tijeras de tungsteno

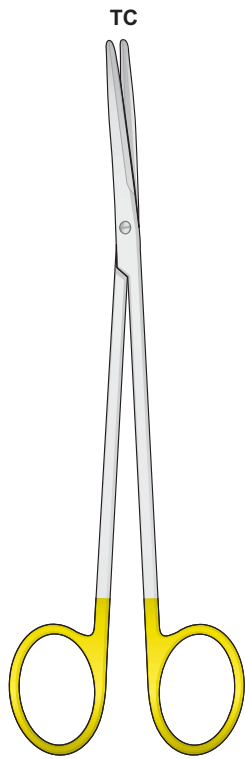

METZENBAUM-FINO
 FM-202/FM-206

TC

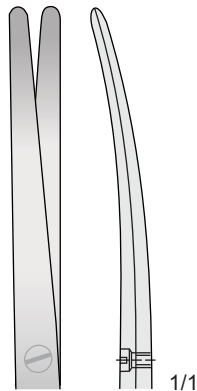

FM-202
 140 mm



FM-204
 180 mm

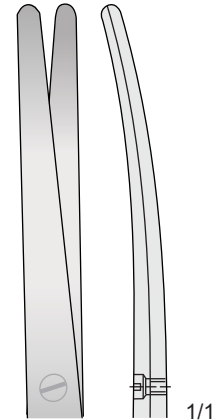

FM-206
 200 mm

Tungsten-Carbide Inserts
 Mit Hartmetalleinsätzen
 Plaquettes en carbure de tungstène
 Plaquetas de carburo de tungsteno
 Inserti in carburo di tungsteno

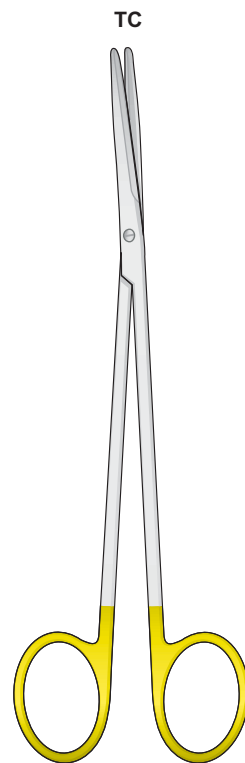

METZENBAUM-FINO
 FM-208/FM-212

TC



FM-208
 230 mm

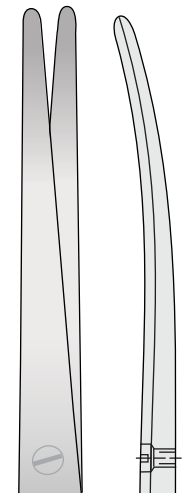

FM-210
 250 mm

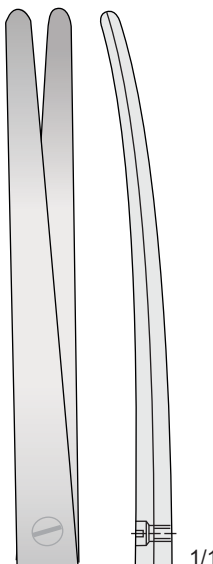

FM-212
 280 mm

Con punta al carburo di tungsteno - Tungsten-carbide scissors
Mit Hartmetalleinsätzen - Avec plaquettes en carbure de tungstène - Tijeras de tungsteno

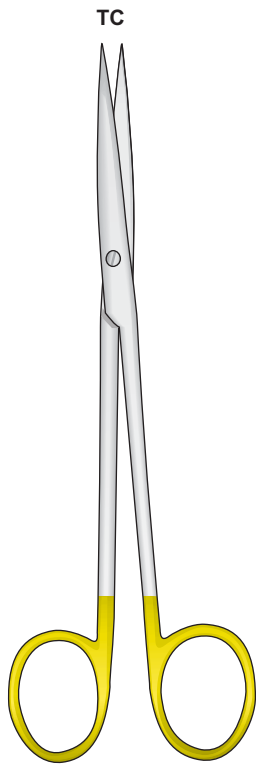

METZENBAUM-FINO
FM-96/FM-99

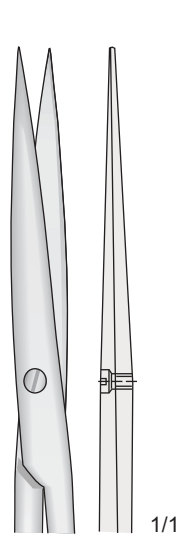

FM-96
140 mm

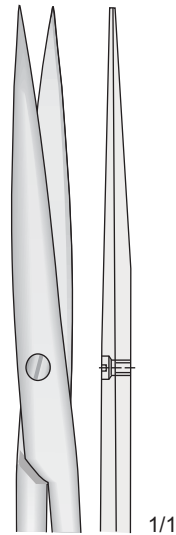

FM-97
180 mm

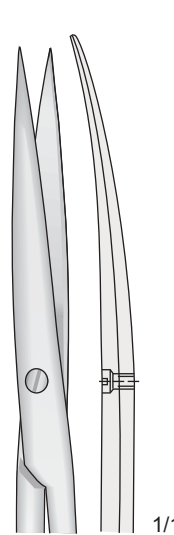

FM-98
140 mm

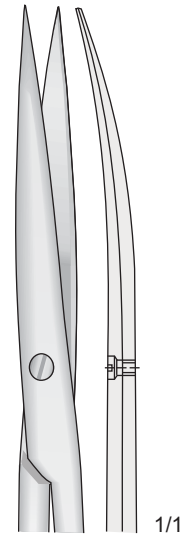

FM-99
180 mm

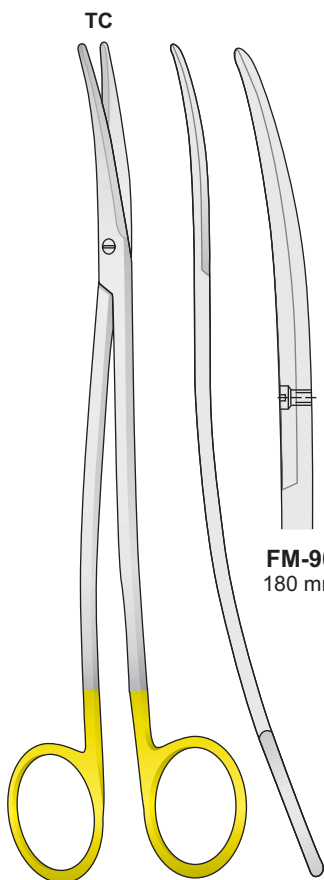
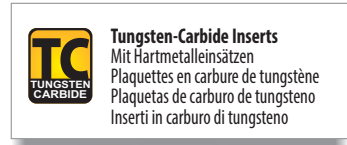

METZENBAUM-FINO
FM-90/FM-94

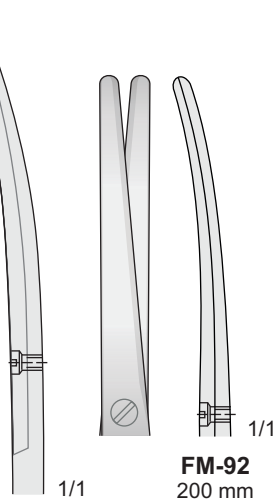

FM-90
180 mm

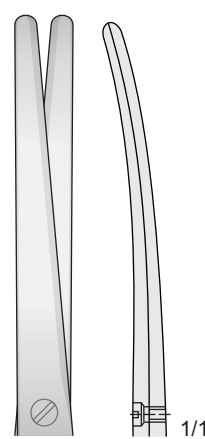

FM-92
200 mm

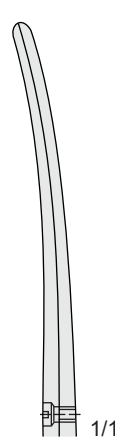

FM-94
230 mm

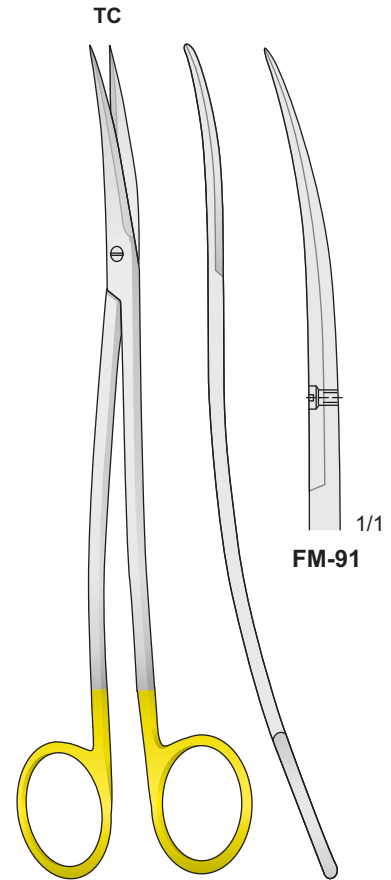

METZENBAUM-FINO
FM-91
180 mm

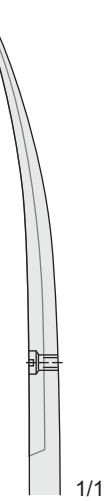

FM-91

03



Con punta al carburo di tungsteno - Tungsten-carbide scissors
 Mit Hartmetalleinsätzen - Avec plaquettes en carbure de tungstène
 Tijeras de tungsteno

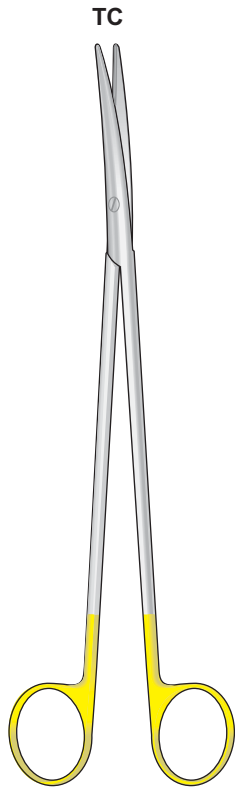

NELSON-METZENBAUM
FM-154/FM-155

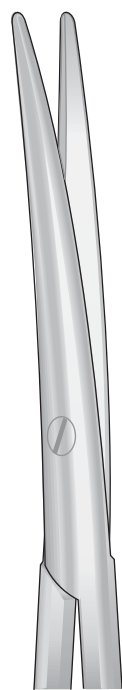

FM-154
 260 mm

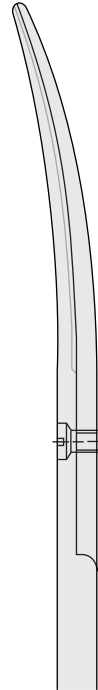

1/1

FM-155
 280 mm



Tungsten-Carbide Inserts
 Mit Hartmetalleinsätzen
 Plaquettes en carbure de tungstène
 Plaquetas de carburo de tungsteno
 Inserti in carburo di tungsteno

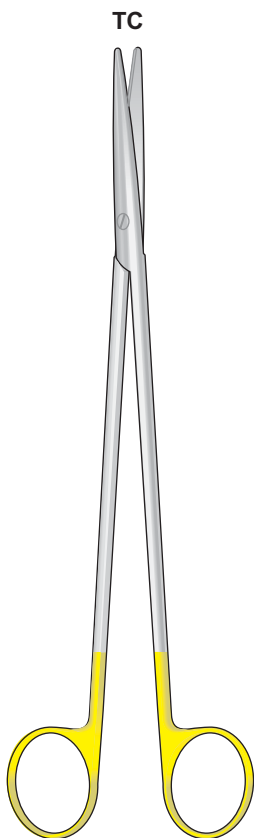

NELSON-METZENBAUM
FM-156/FM-159

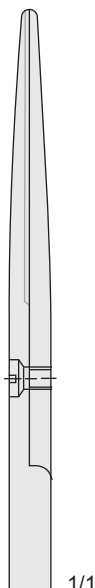

FM-156
 230 mm

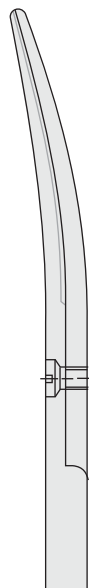
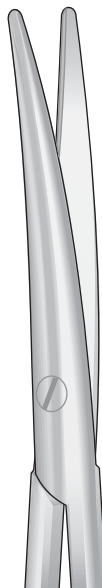

FM-157
 230 mm



1/1

FM-159
 300 mm

TC Con punta al carburo di tungsteno - Tungsten-carbide scissors
Mit Hartmetalleinsätzen - Avec plaquettes en carbure de tungstène - Tijeras de tungsteno

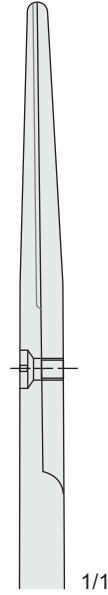
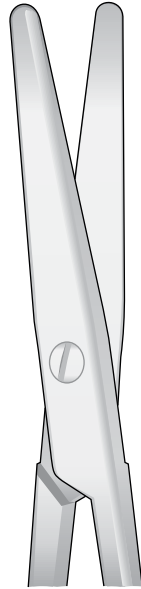

FM-130
140 mm

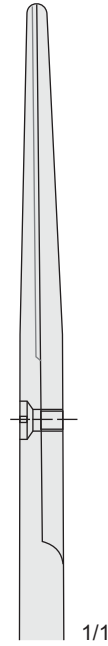

FM-131
170 mm

MAYO-STILLE
FM-130/FM-131
TC



Tungsten-Carbide Inserts
Mit Hartmetalleinsätzen
Plaquettes en carbure de tungstène
Plaquetas de carburo de tungsteno
Inserti in carburo di tungsteno

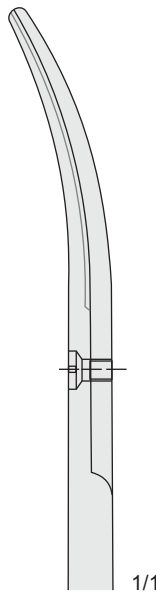
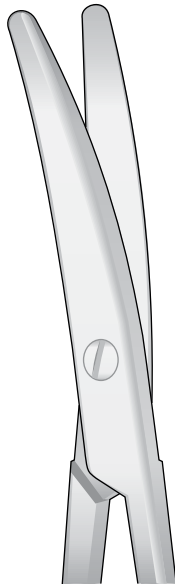
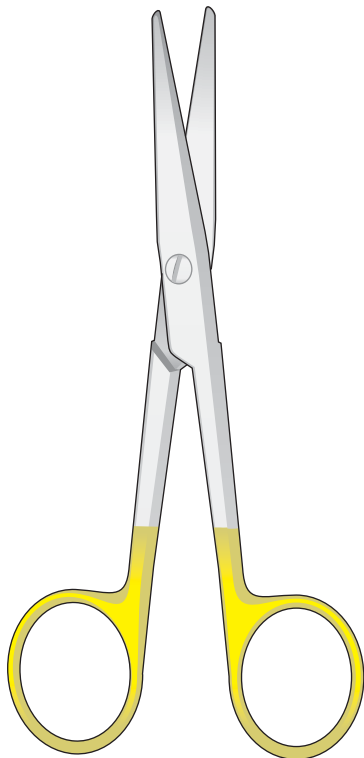

FM-132
140 mm

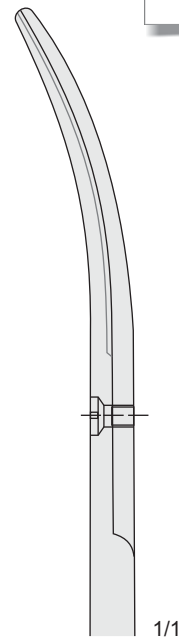

FM-133
170 mm

MAYO-STILLE
FM-132/FM-133

03



Con punta al carburo di tungsteno - Tungsten-carbide scissors
 Mit Hartmetalleinsätzen - Avec plaquettes en carbure de tungstène - Tijeras de tungsteno

TC

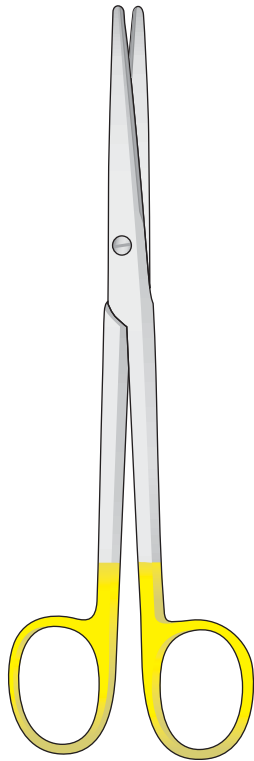

LEXER
 FM-134/FM-135
 TC

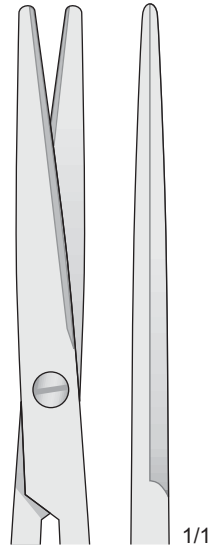

FM-134
 160 mm

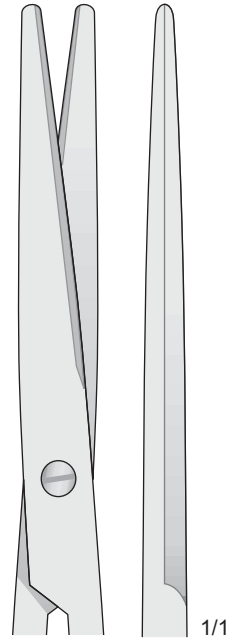

FM-135
 210 mm



Tungsten-Carbide Inserts
 Mit Hartmetalleinsätzen
 Plaquettes en carbure de tungstène
 Plaquetas de carburo de tungsteno
 Inserti in carburo di tungsteno

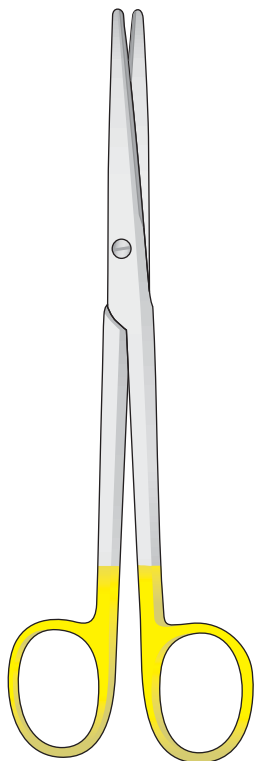

LEXER
 FM-136/FM-137

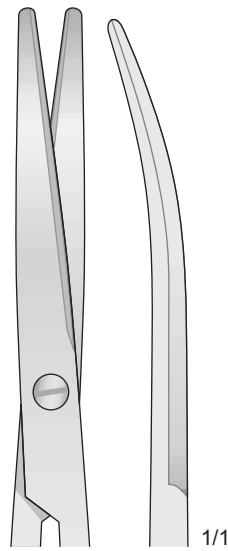

FM-136
 160 mm

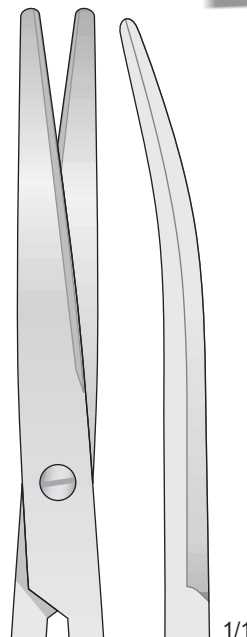

FM-137
 210 mm

Con punta al carburo di tungsteno - Tungsten-carbide scissors
Mit Hartmetalleinsätzen - Avec plaquettes en carbure de tungstène - Tijeras de tungsteno

TC

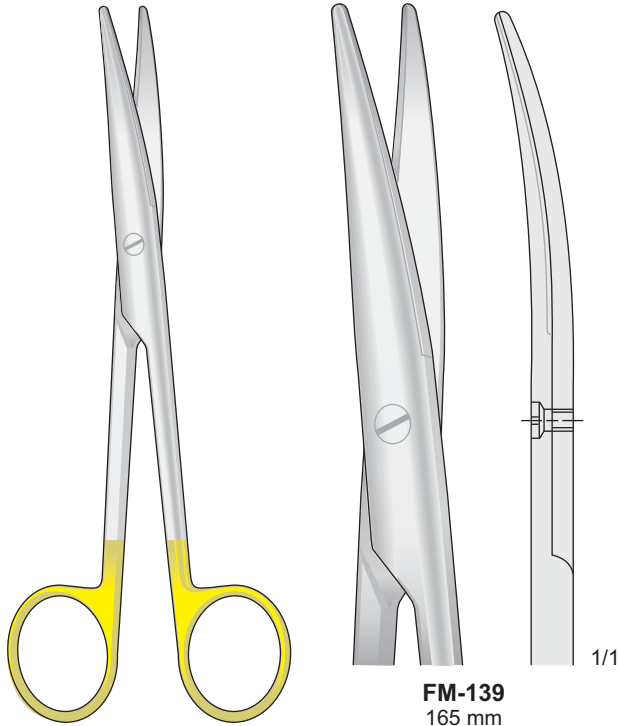

FM-139
165 mm

MAYO-LEXER
FM-139
165 mm

TC
TUNGSTEN
CARBIDE

Tungsten-Carbide Inserts
Mit Hartmetalleinsätzen
Plaquettes en carbure de tungstène
Plaquetas de carburo de tungsteno
Inserti in carburo di tungsteno

TC

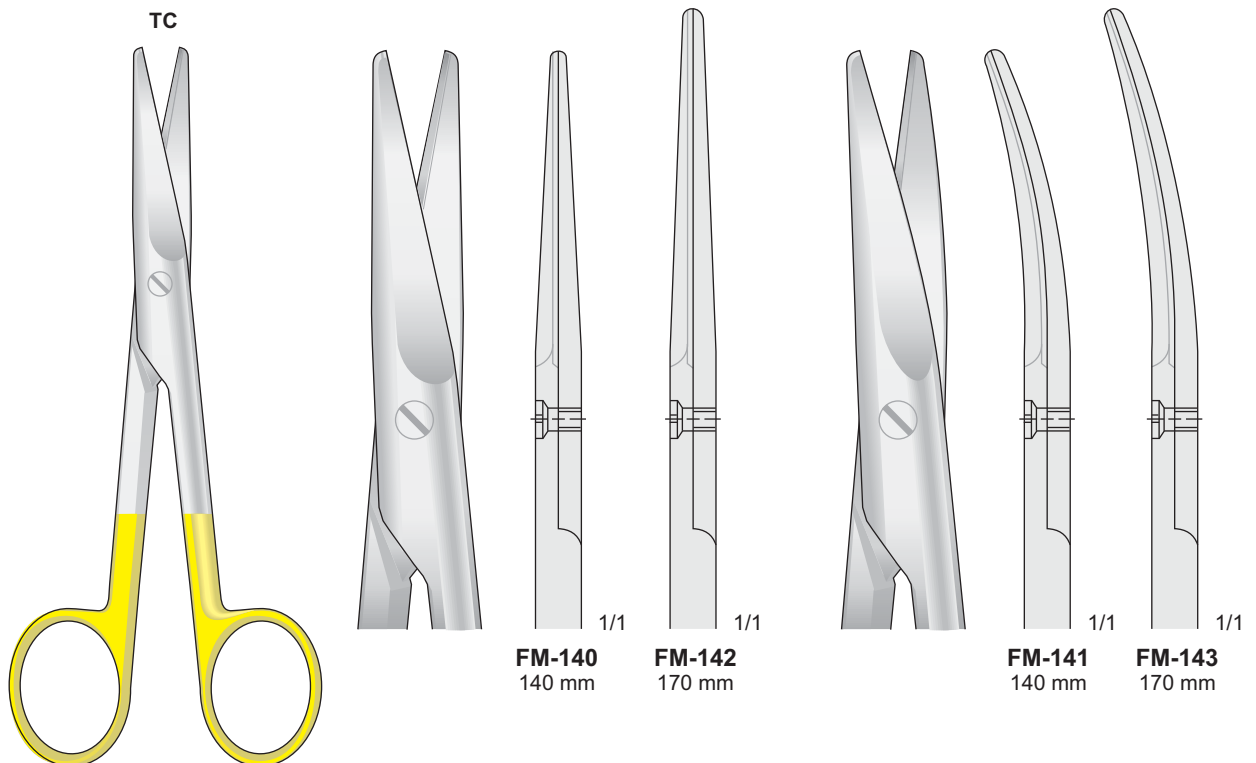

FM-140
140 mm

FM-142
170 mm

FM-141
140 mm

FM-143
170 mm

MAYO
FM-140/FM-143

Con punta al carburo di tungsteno - Tungsten-carbide scissors
 Mit Hartmetalleinsätzen - Avec plaquettes en carbure de tungstène - Tijeras de tungsteno

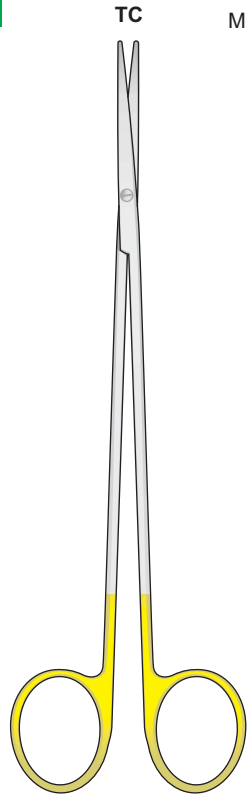

TOENNIS-ADSON
FG-63/FG-64
 180 mm

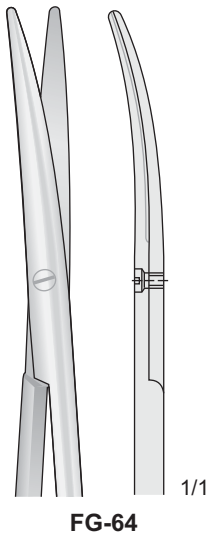
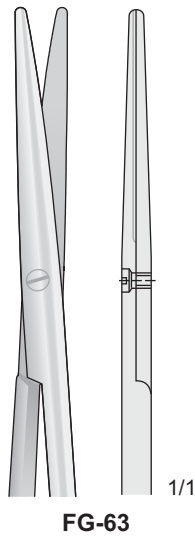

Tungsten-Carbide Inserts
 Mit Hartmetalleinsätzen
 Plaquettes en carbure de tungstène
 Plaquetas de carburo de tungsteno
 Inserti in carburo di tungsteno

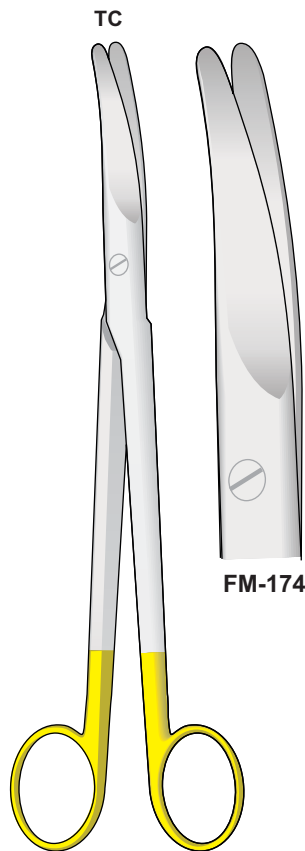

PARAMETRIUM-PARAMETRIO
FM-174
 225 mm

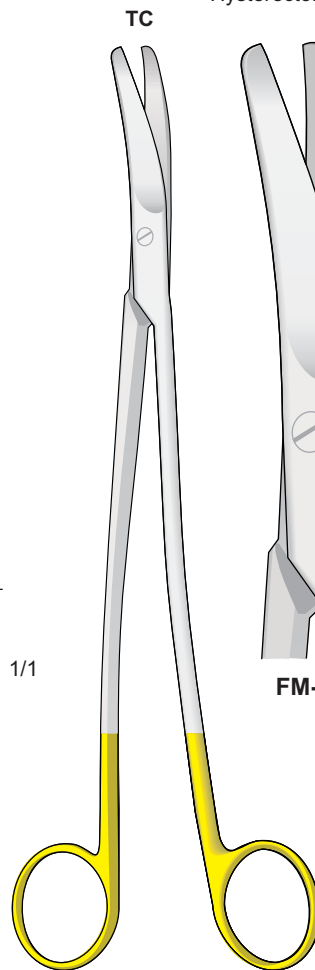
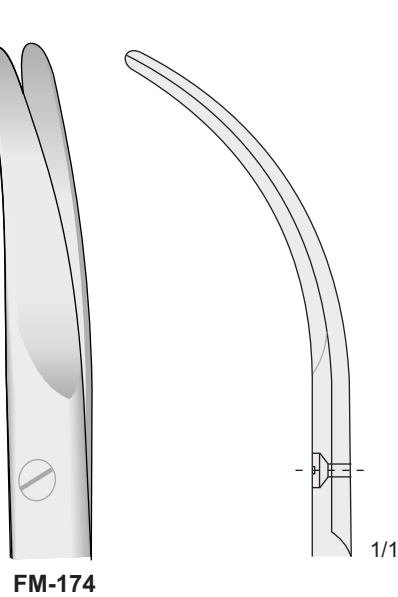

FM-193
 250 mm

Forbice per isterectomia - Hysterectomy Scissors
 Hysterectomie Scheren - Ciseaux à Hystérérectomie
 Tijera para Histerectomia

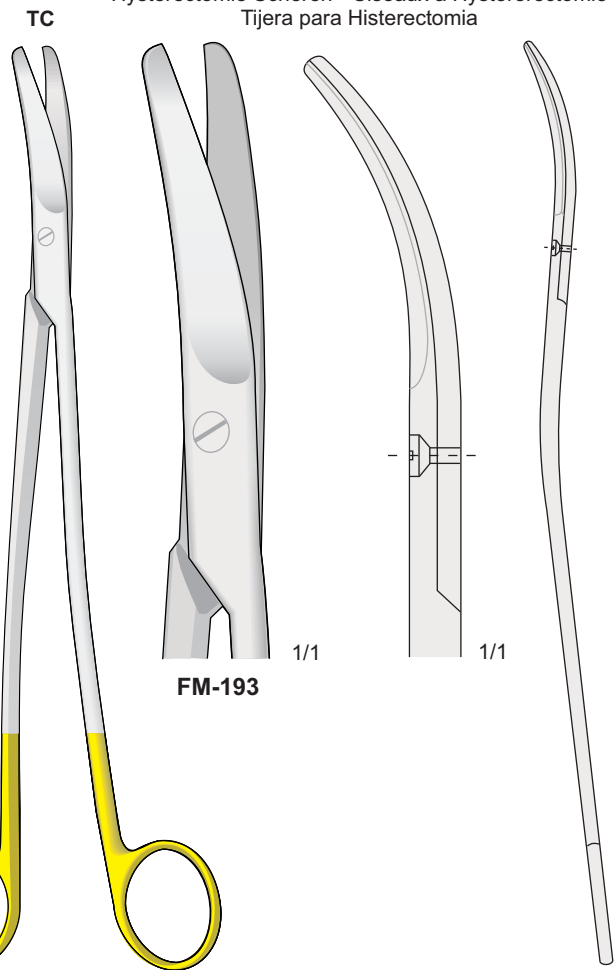

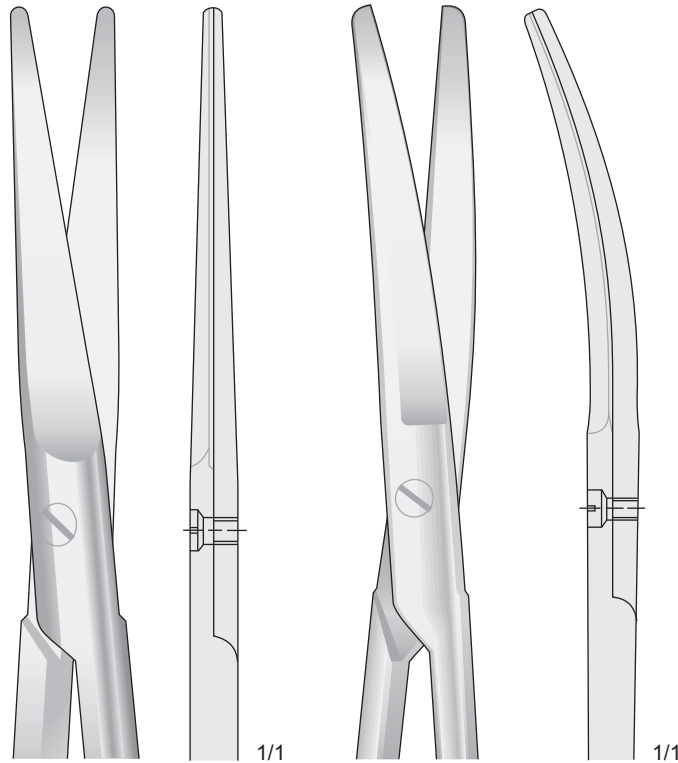

FM-190

FM-194-TC

Con punta al carburo di tungsteno
Tungsten-carbide scissors
Mit Hartmetalleinsätzen
Avec plaquettes en carbure de tungstène
Tijeras de tungsteno



Tungsten-Carbide Inserts
Mit Hartmetalleinsätzen
Plaquettes en carbure de tungstène
Plaquetas de carburo de tungsteno
Inserti in carburo di tungsteno

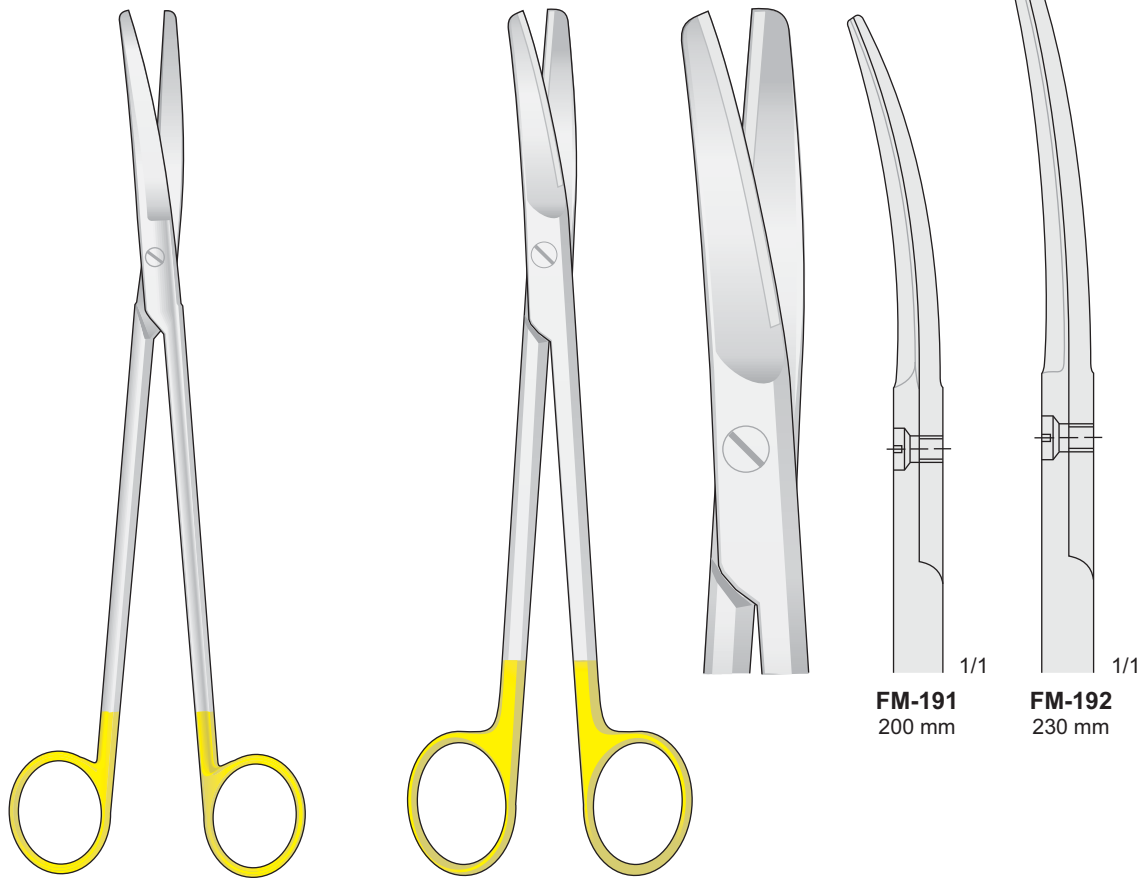

WERTHEIM
FM-190/FM-194
230 mm

SIMS
FM-191/FM-192

FM-191
200 mm

FM-192
230 mm

Forbici con taglio ondulato su una lama
 Scissors cut one serrated cutting edge
 Scheren mit wellenschliff auf einer Schnittfläche
 Ciseaux avec affutage spécial ont une lame dentée



Tungsten-Carbide Inserts
 Mit Hartmetalleinsätzen
 Plaquettes en carbure de tungstène
 Plaquetas de carburo de tungsteno
 Inserti in carburo di tungsteno

Wellenschliff
 TC

Wellenschliff
 TC

Wellenschliff
 TC

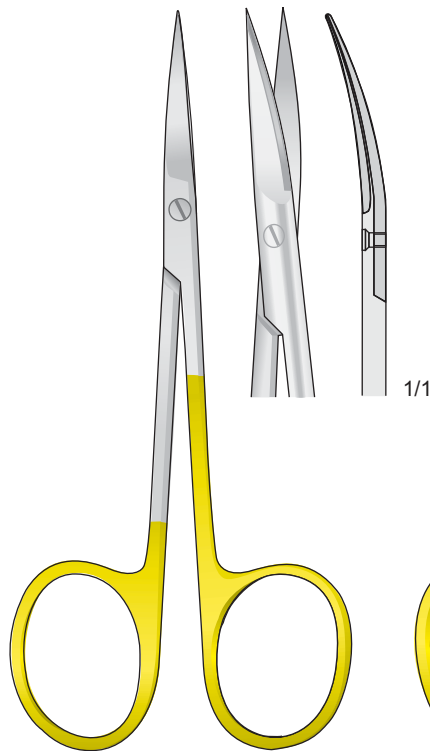

IRIS
FM-100
 110 mm

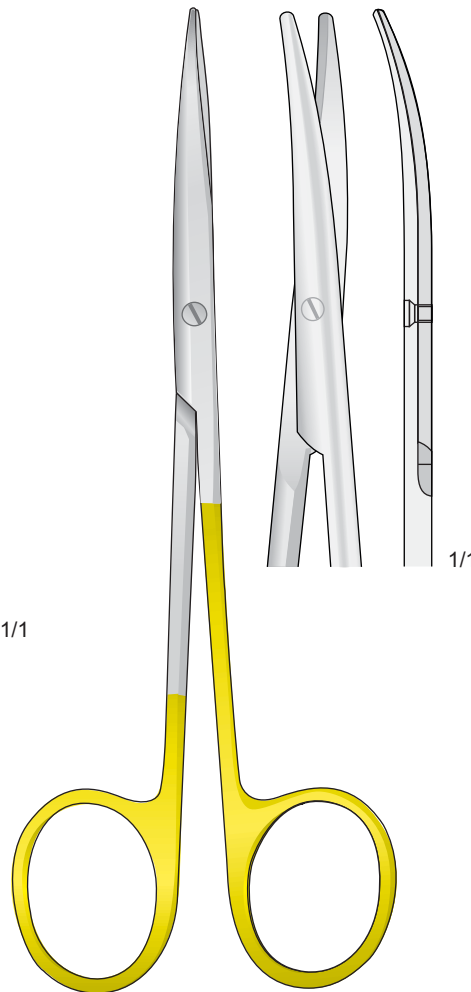

METZENBAUM
FM-102
 145 mm

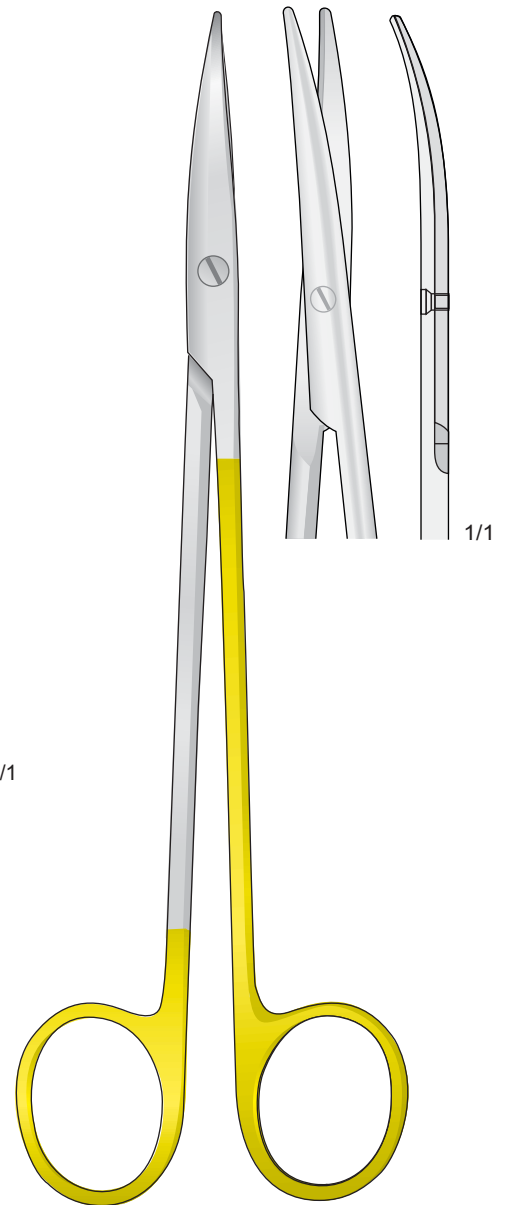

METZENBAUM
FM-104
 185 mm

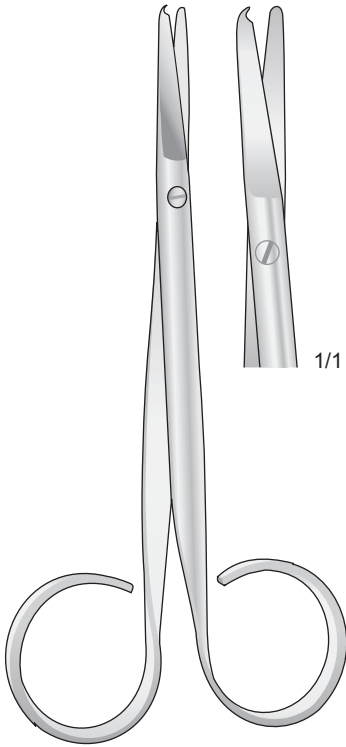

SPENCER
SC-1
110 mm

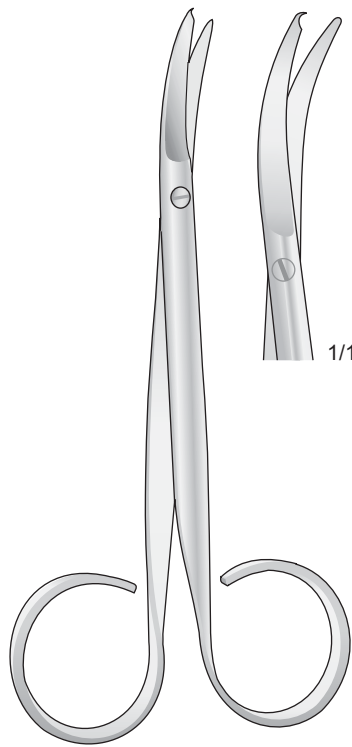

SPENCER
SC-5
110 mm

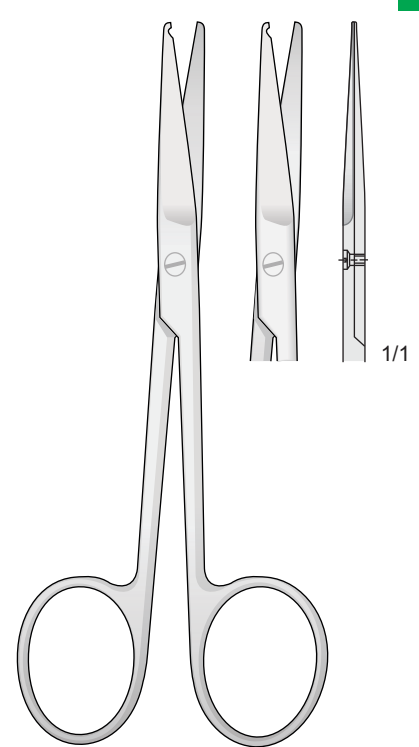

SC-12
115 mm

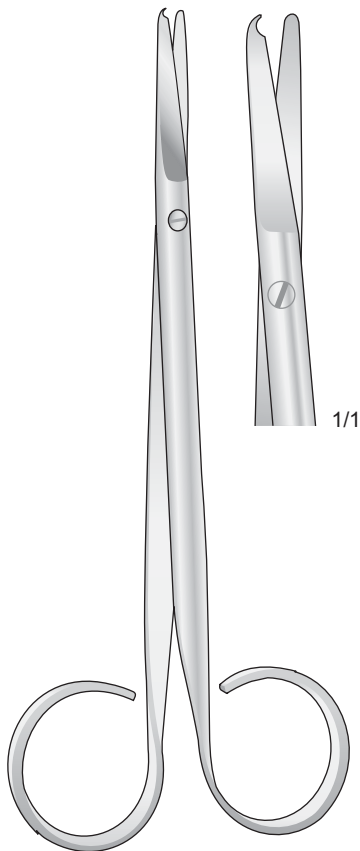

SPENCER
SC-2
145 mm

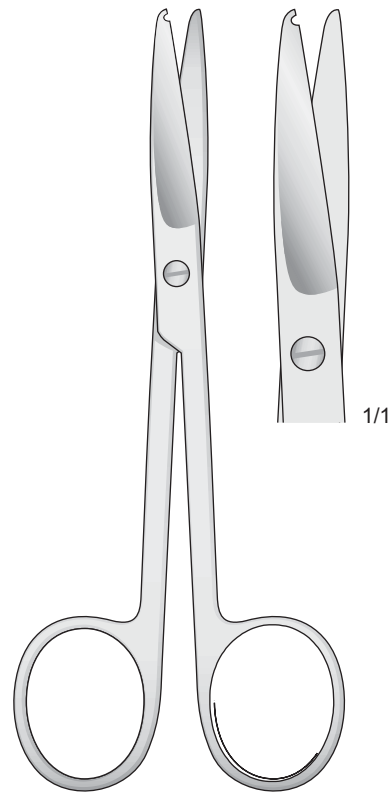

SPENCER
SC-10
135 mm

03

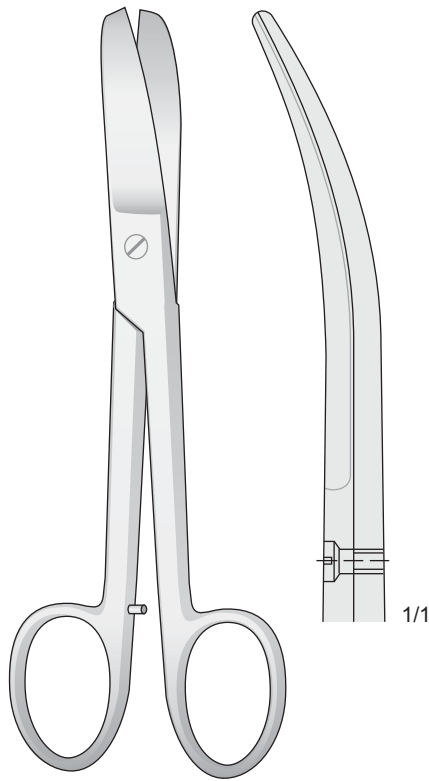

LORENZ
FG-150
230 mm



BRUNS
FG-181
240 mm

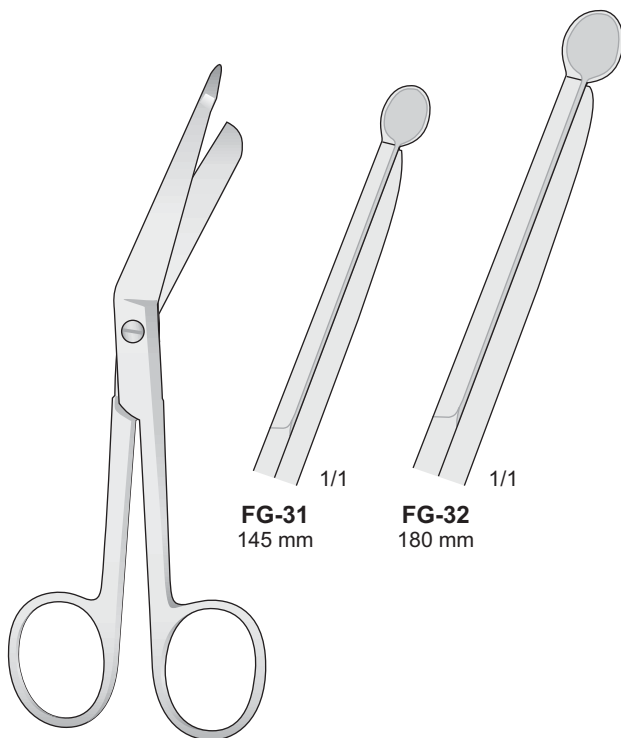

LISTER
FG-31/FG-32



ESMARCH
FG-33

FG-31
145 mm

FG-32
180 mm

FG-33
200 mm

Forbice universale dentellata
Draht- und Blehschere gezahnt
Wire cutting scissor serrated
Coupe-fils dentelés
Tijeras para cortar hilo de acero dentadas

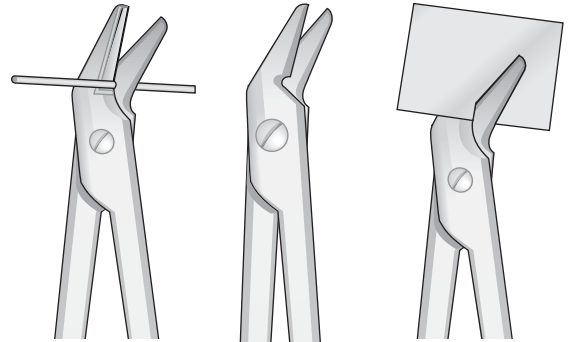

TC
TUNGSTEN
CARBIDE

Tungsten-Carbide Inserts
Mit Hartmetalleinsätzen
Plaquettes en carbure de tungstène
Plaquetas de carburo de tungsteno
Inserti in carburo di tungsteno

Con punta al carburo di tungsteno
Tungsten-carbide scissors
Mit Hartmetalleinsätzen
Avec plaquettes en carbure de tungstène
Tijeras de tungsteno

Wire Cutter
TC

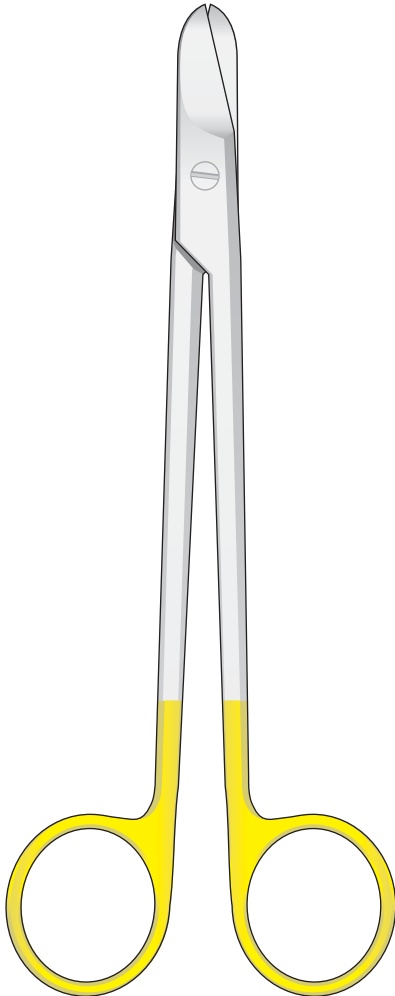

**SMITH
FG-160**
160 mm

Wire Cutter
TC

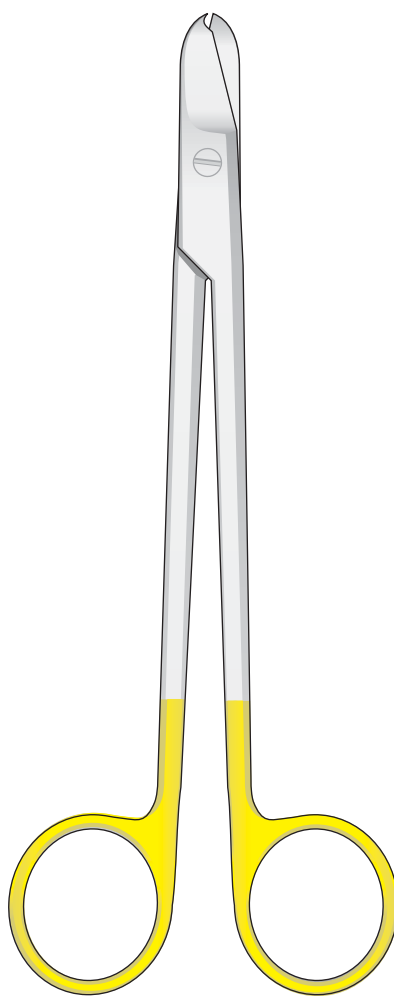

**SMITH
FG-161**
160 mm

DP-90
120 mm

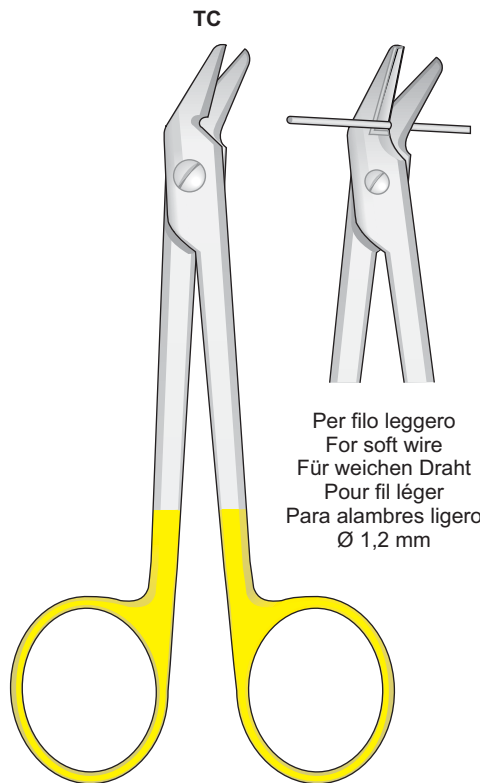

DP-120
120 mm

Per filo leggero
For soft wire
Für weichen Draht
Pour fil léger
Para alambres ligero
Ø 1,2 mm

Smusse - Blunt - Stumpf - Mousses - Romas

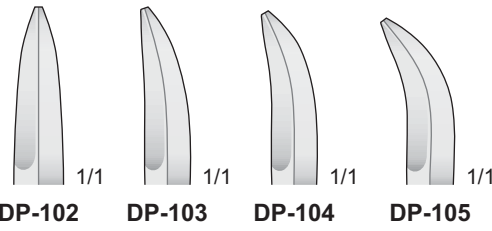
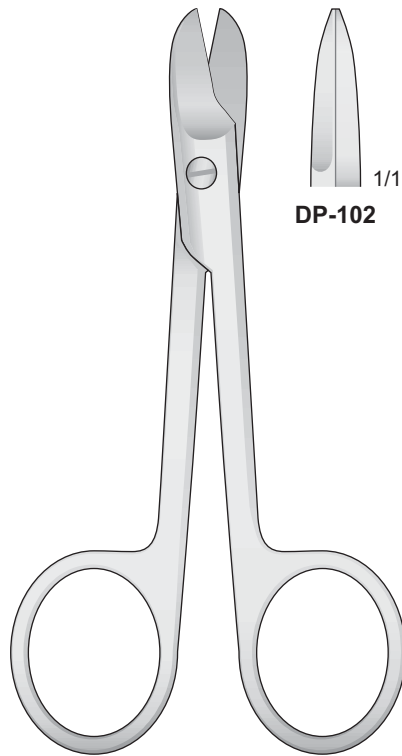

BEEBE
DP-102/DP-105
110 mm

Acute - Sharp - Spitz - Pointus - Agudas

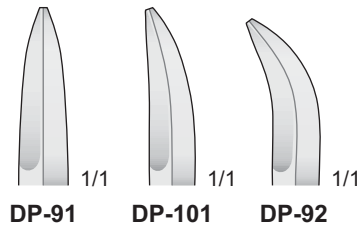
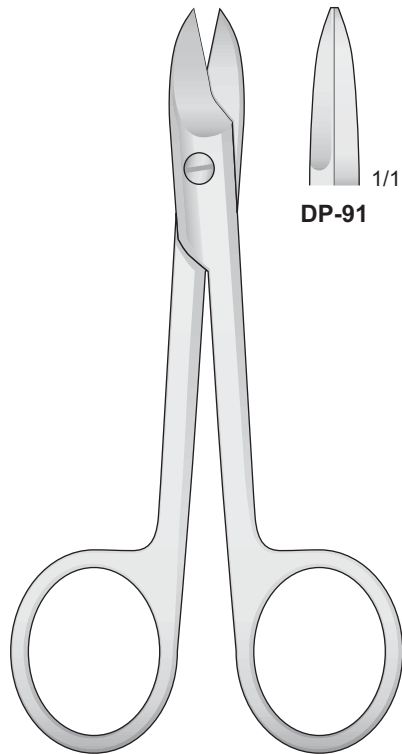

BEEBE
DP-91/DP-101
110 mm

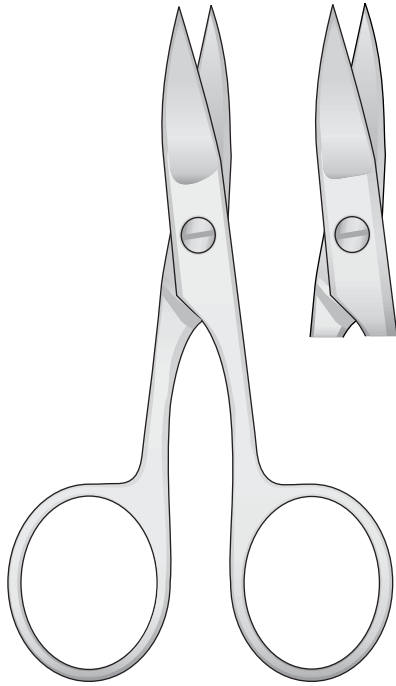

GS-23/GS-26

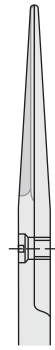

1/1

GS-23
90 mm



1/1

GS-24
90 mm



1/1

GS-25
100 mm



1/1

GS-26
110 mm



GS-27/GS-29

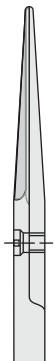

1/1

GS-27
95 mm

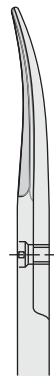

1/1

GS-28
95 mm



1/1

GS-29
105 mm

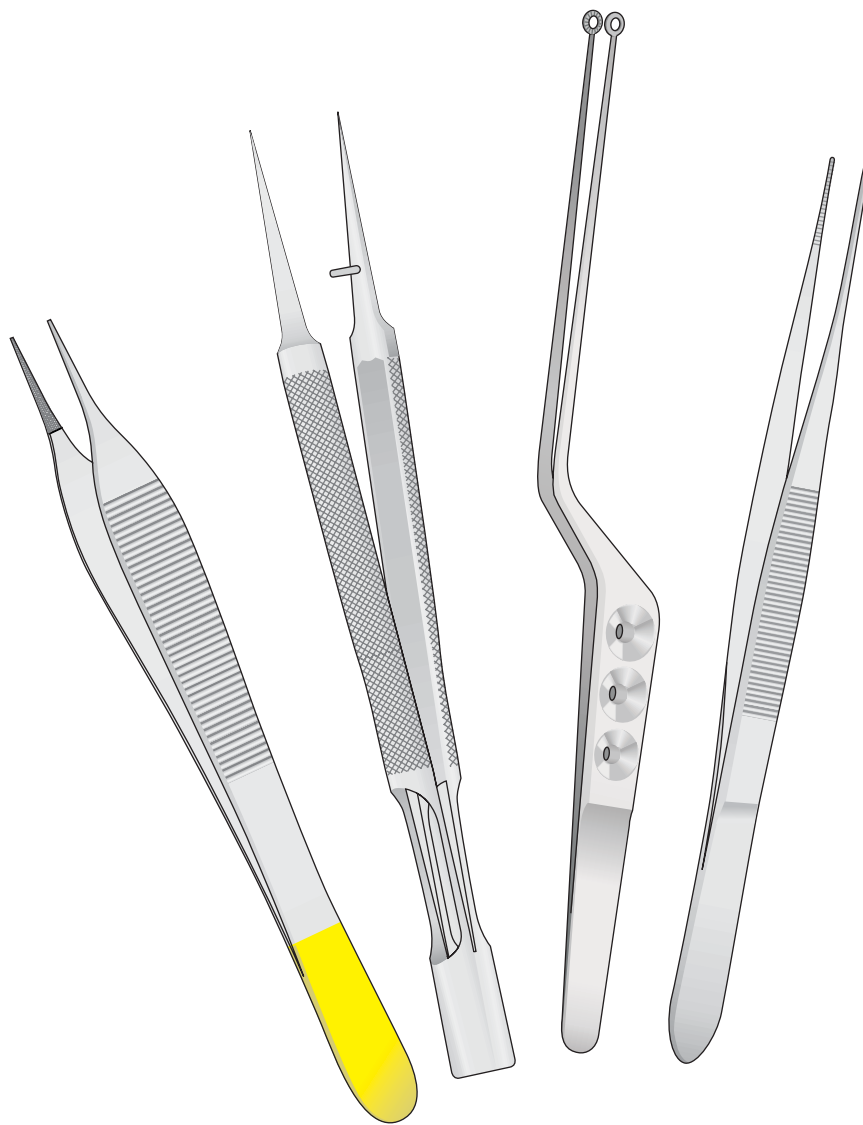

04 |

Tissue and Dressing Forceps
Chirurgische und Anatomische Pinzetten
Pinces à tissu et à pansement
Pinzas quirúrgicas y anatómicas
Pinzette chirurgiche e anatomiche

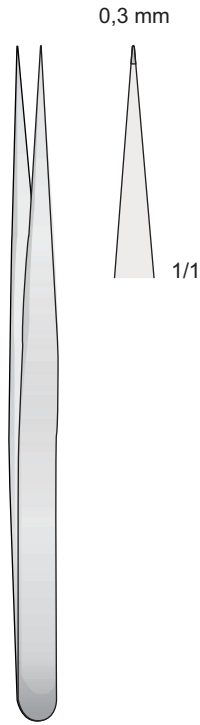

BD-235
120 mm

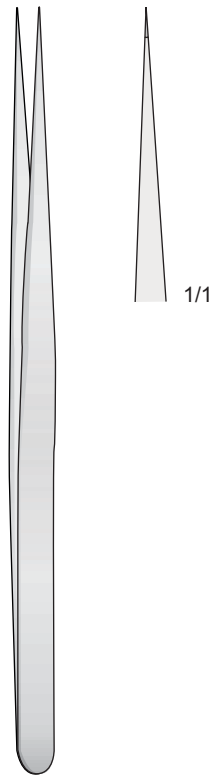

**WISE
BD-236**
135 mm

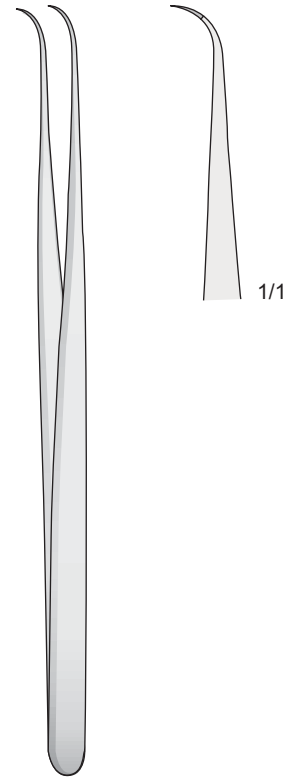

**WISE
BD-237**
135 mm

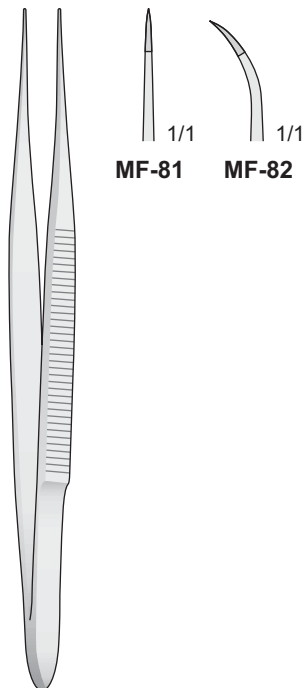

MF-81/MF-82
125 mm

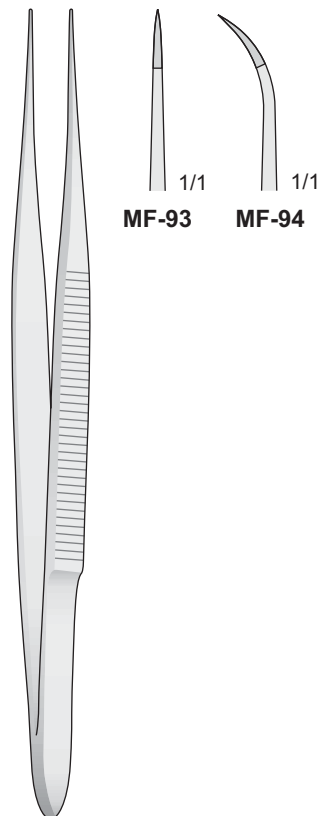

MF-93/MF-94
150 mm

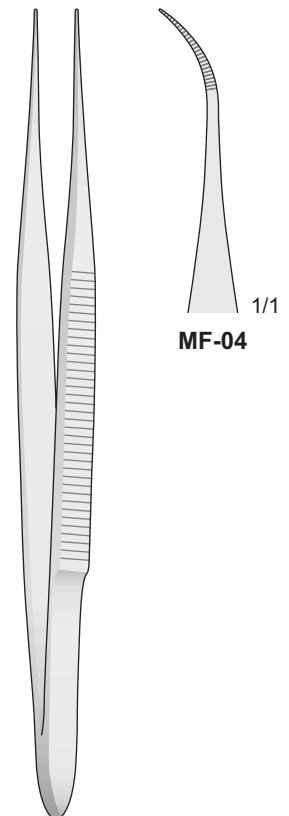

MF-04
150 mm

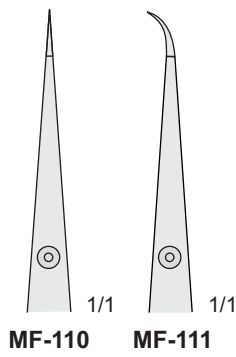
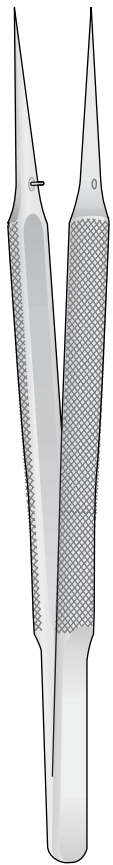

MF-110/MF-111
120 mm

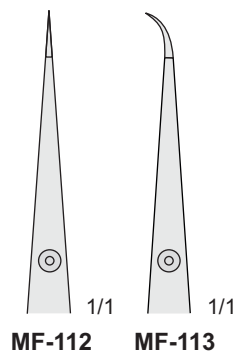
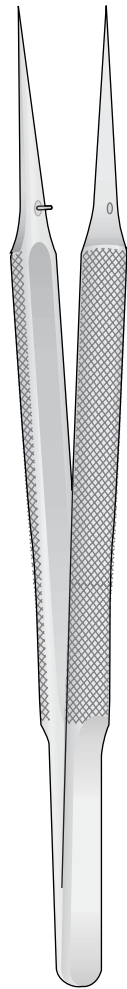

MF-112/MF-113
150 mm

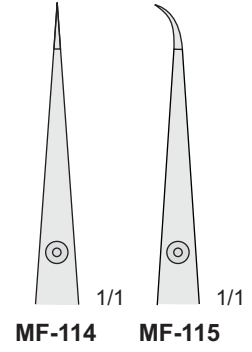
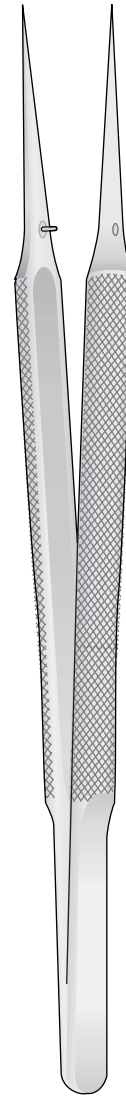

MF-114/MF-115
180 mm

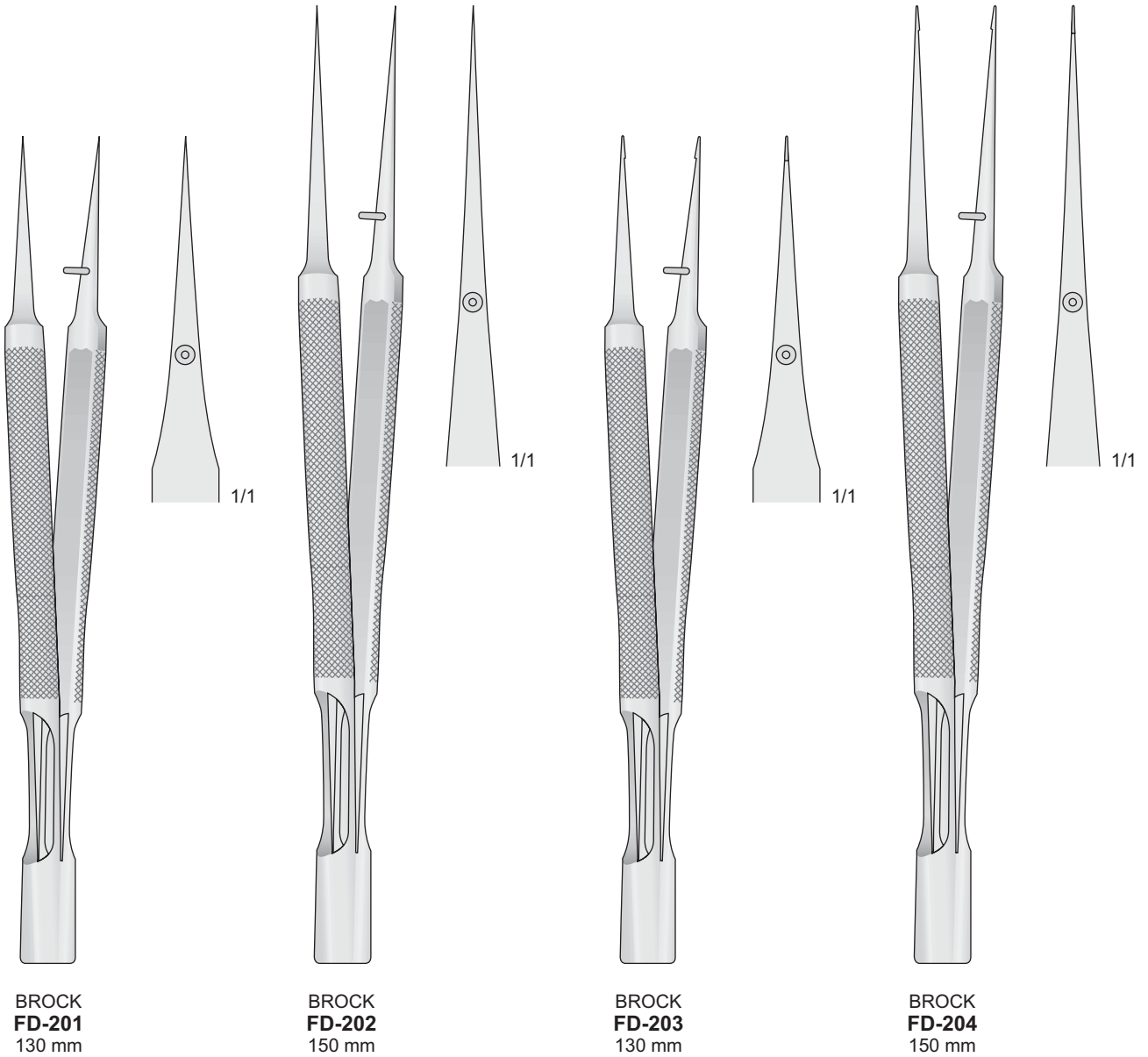
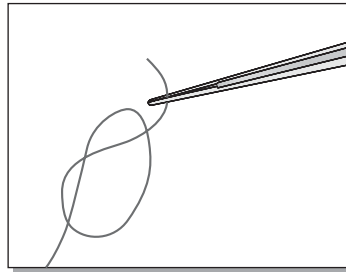

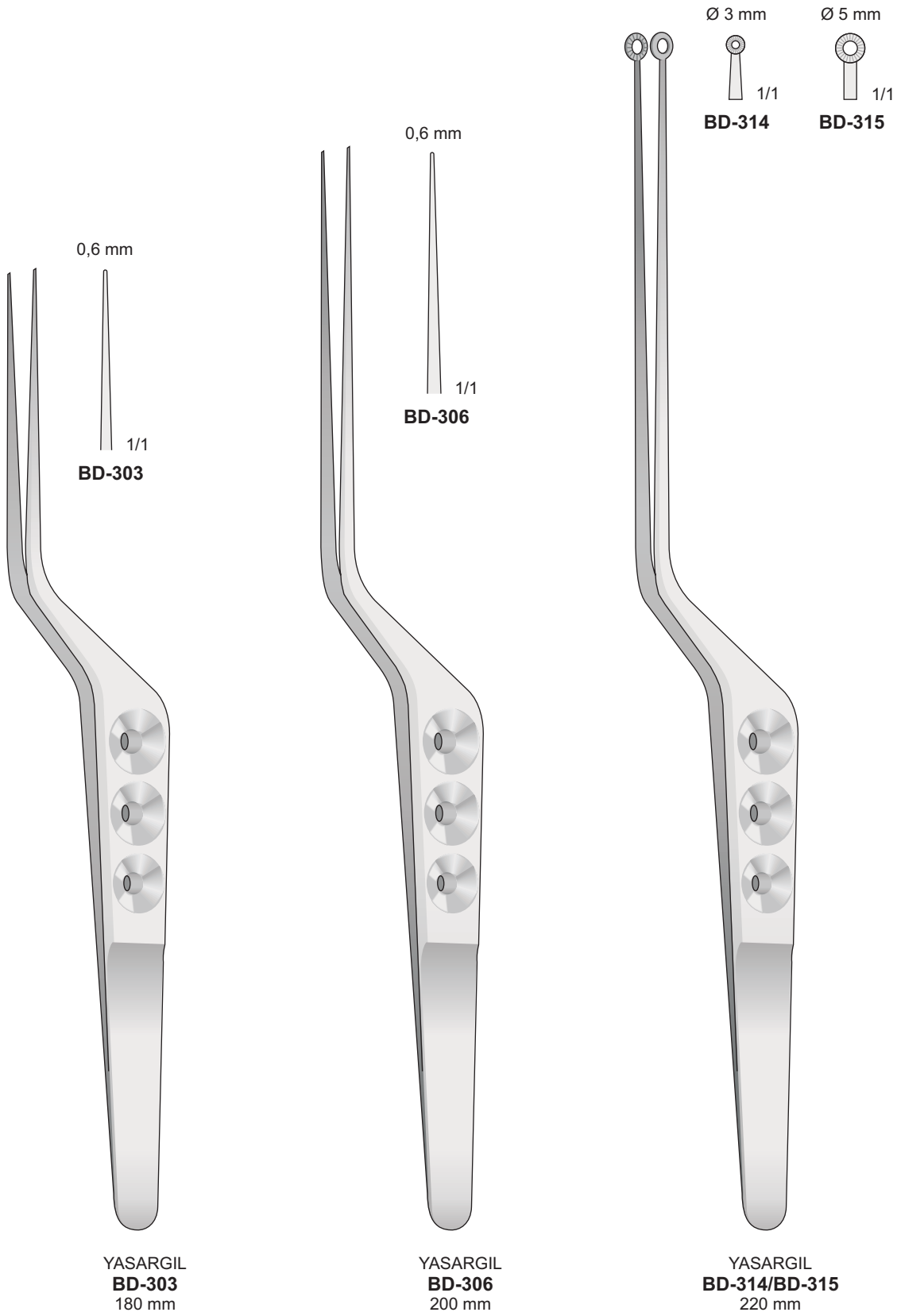





MF-124/MF-149

Ø 1 mm



MF-124 - 150 mm
MF-125 - 180 mm
MF-126 - 210 mm
MF-148 - 230 mm

Ø 2 mm



MF-127 - 150 mm
MF-128 - 180 mm
MF-129 - 210 mm
MF-149 - 230 mm



MF-142 T/MF-147 T

Titanio - Titan - Titane
 Ø 1 mm



MF-142 T - 150 mm
MF-143 T - 180 mm
MF-144 T - 210 mm

Ø 2 mm



MF-145 T - 150 mm
MF-146 T - 180 mm
MF-147 T - 210 mm

04

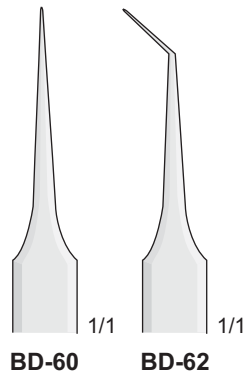
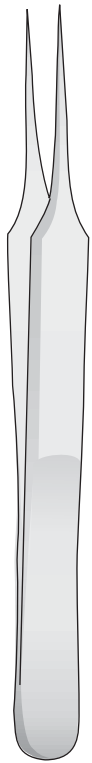

BD-60

BD-62

BD-60/BD-62
110 mm

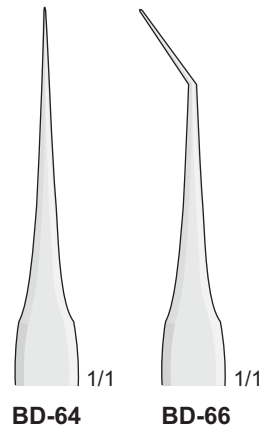
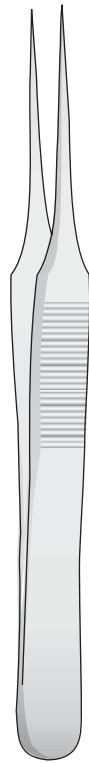

BD-64

BD-66

BD-64/BD-66
110 mm

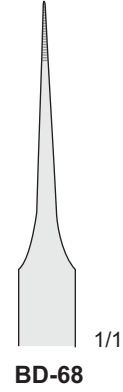

BD-68

BD-68
90 mm

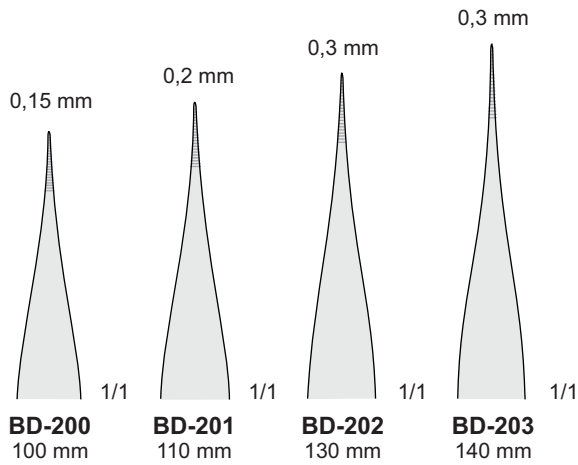
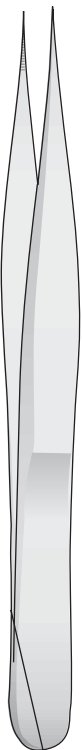

BD-200
100 mm

BD-201
110 mm

BD-202
130 mm

BD-203
140 mm

BD-200/BD-203



BD-205
115 mm



BD-206
115 mm

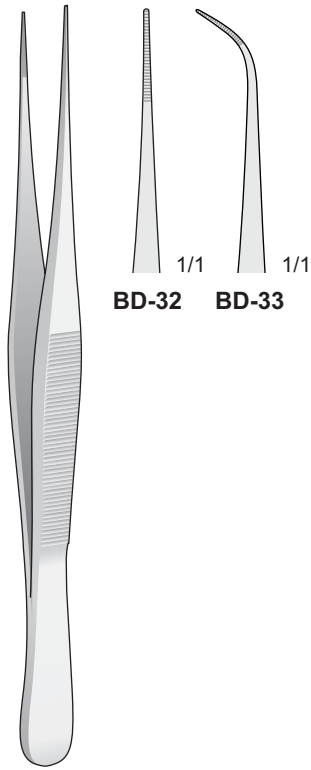

BD-32 **BD-33**

BD-32/BD-33
100 mm

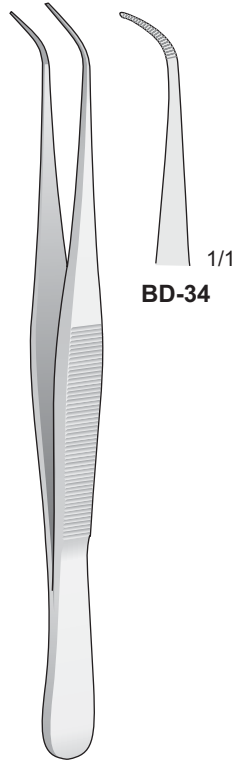

BD-34

BD-34
100 mm

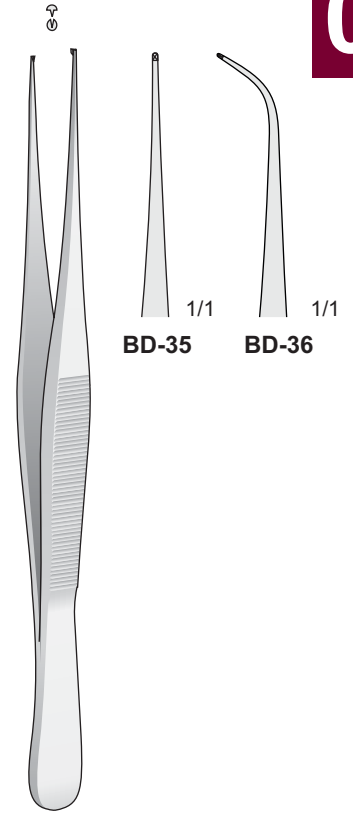

BD-35 **BD-36**

BD-35/BD-36
100 mm

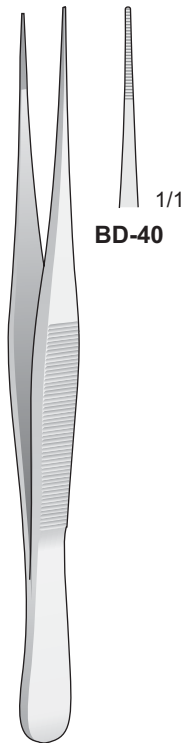

BD-40

BD-40
110 mm

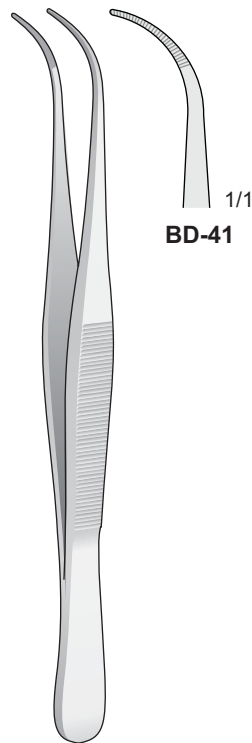

BD-41

BD-41
110 mm

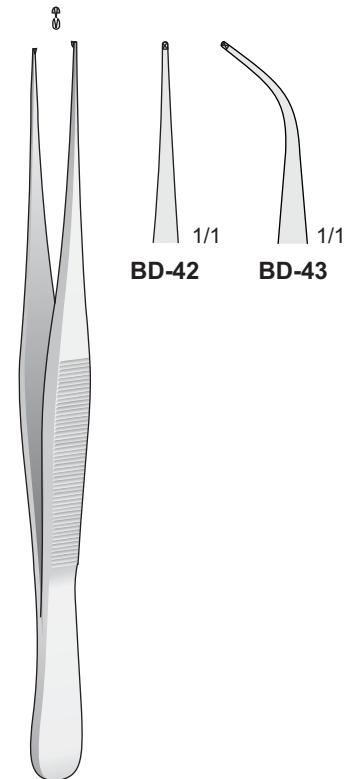

BD-42 **BD-43**

BD-42/BD-43
110 mm

04



GRAEFE
BD-04/BD-07
100 mm

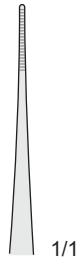

BD-04

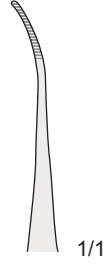

BD-96

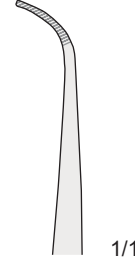

BD-07



GRAEFE
BD-194/BD-196
100 mm



BD-194



BD-195

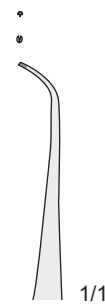

BD-196

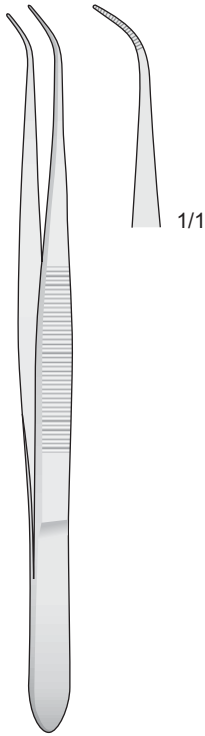

PERRY
BD-05
125 mm

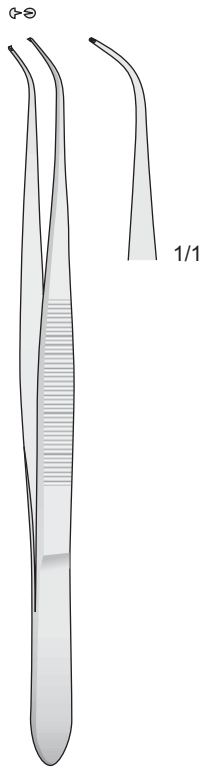

PERRY
BD-06
125 mm



BD-238/BD-239

1x2 denti
0,2 mm
1/1
BD-238
95 mm

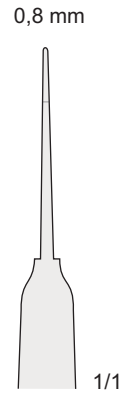

AUSTIN
BD-239
140 mm

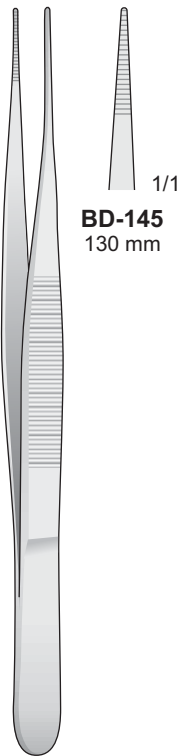

BD-145
130 mm

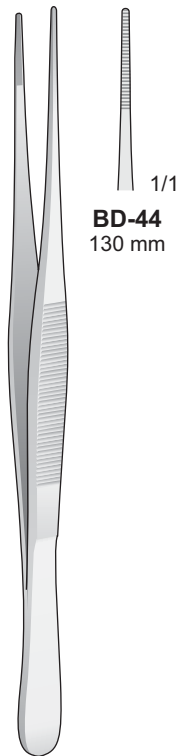

SEMKEN
BD-44
130 mm

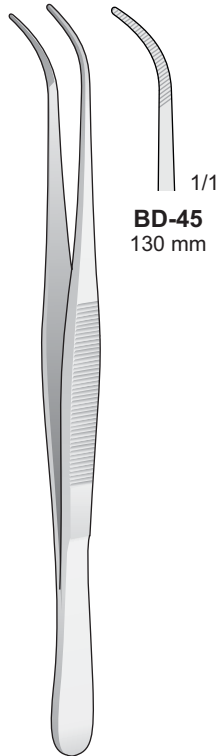

SEMKEN
BD-45
130 mm

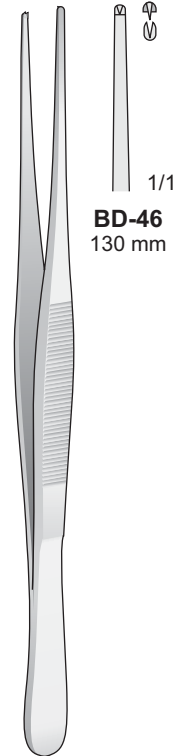

SEMKEN
BD-46
130 mm

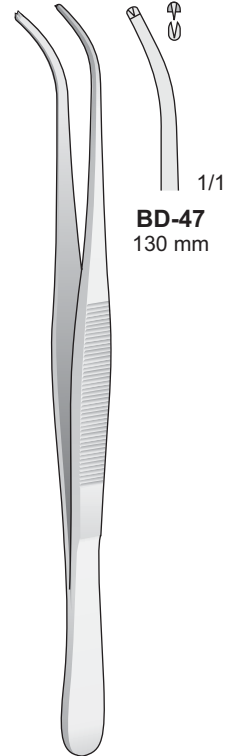

SEMKEN
BD-47
130 mm

04

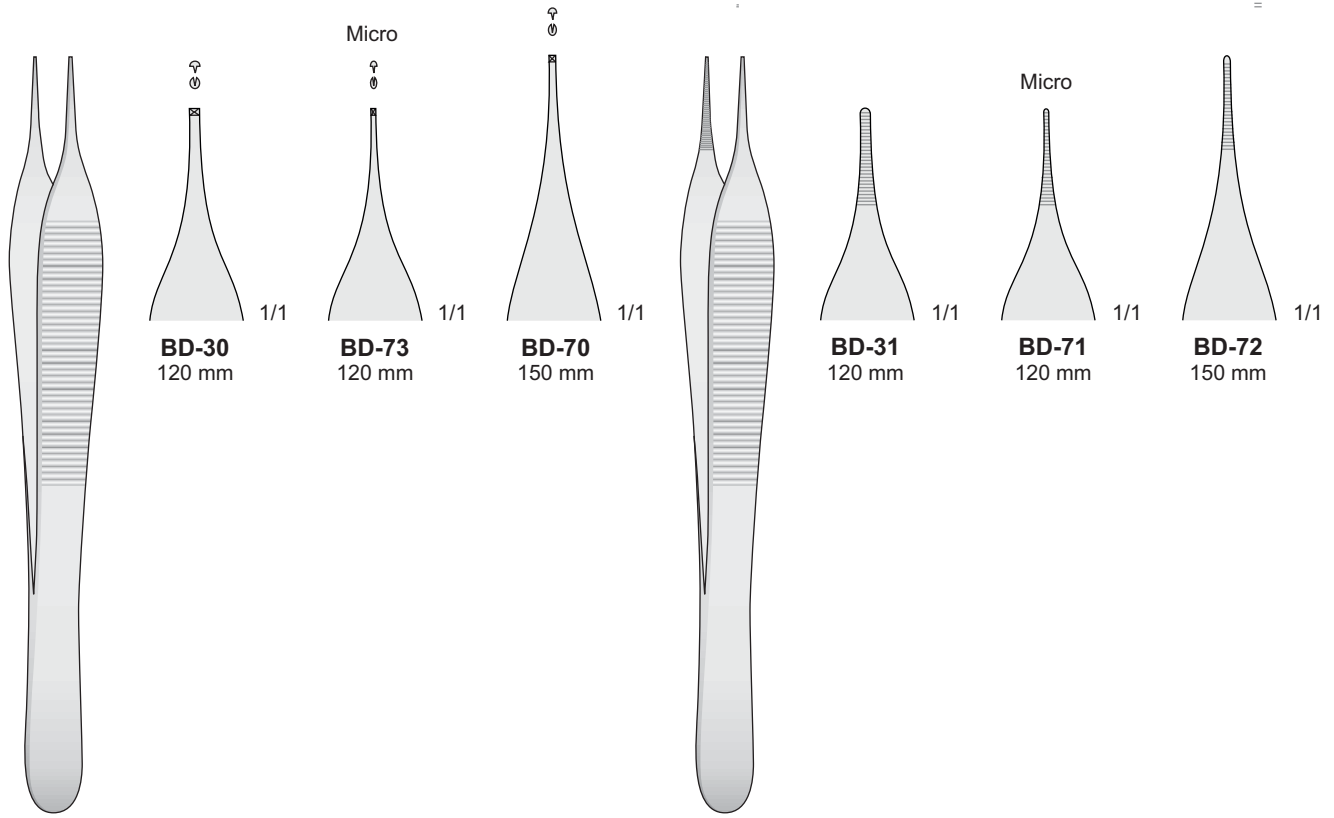

ADSON
BD-30/BD-73

ADSON
BD-31/BD-72

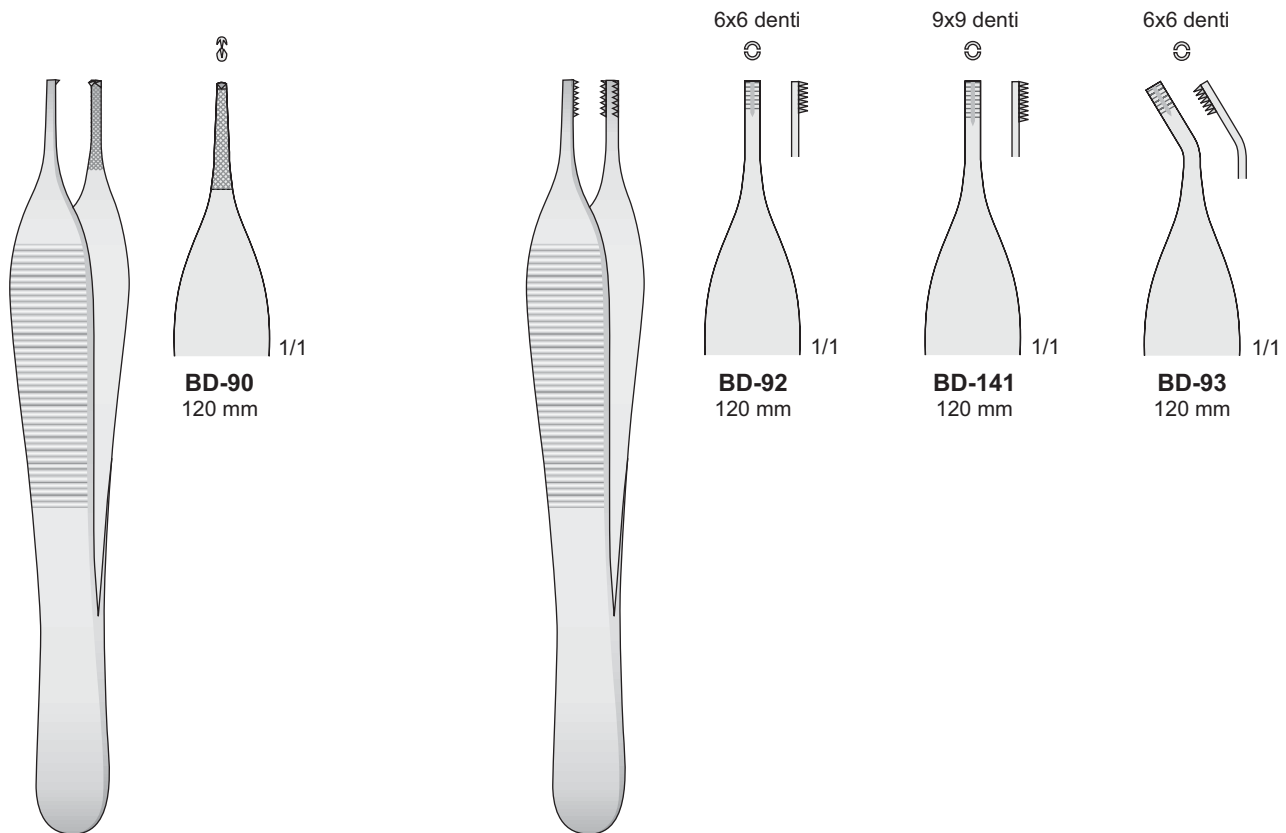

ADSON
BD-90
120 mm

ADSON-BROWN
BD-92/BD-141
120 mm

Standard

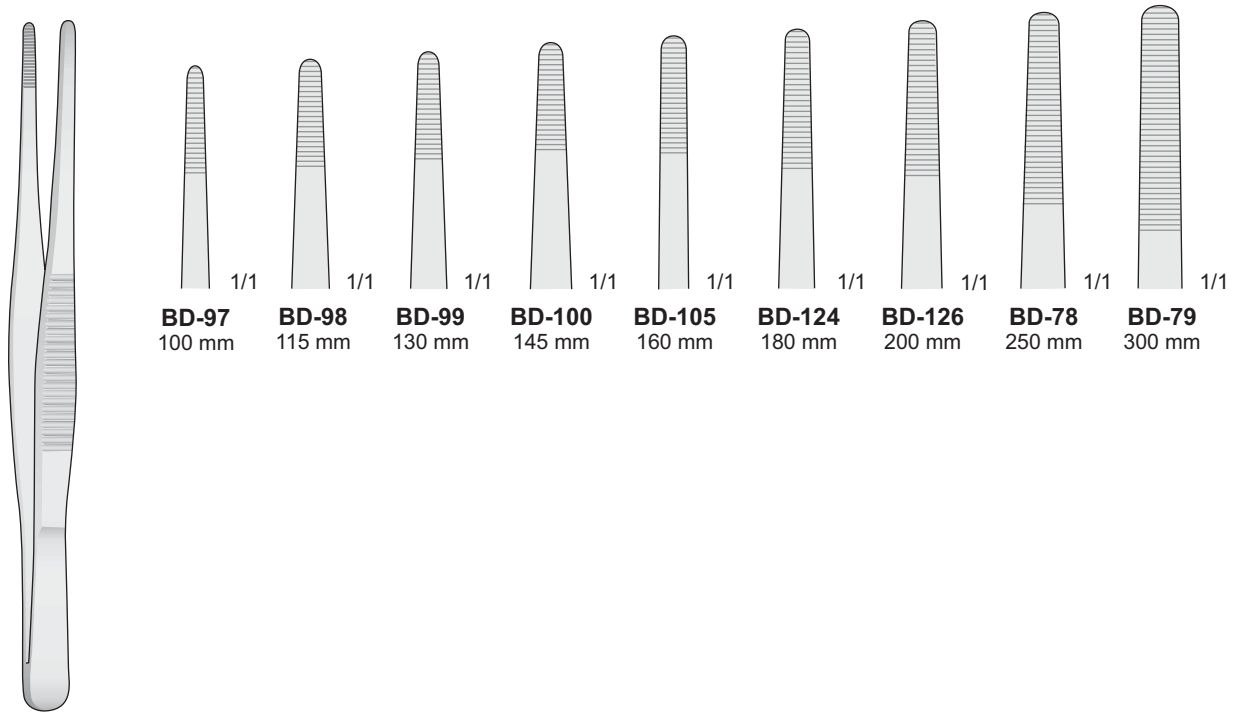

BD-78/BD-126

Mod. Fine

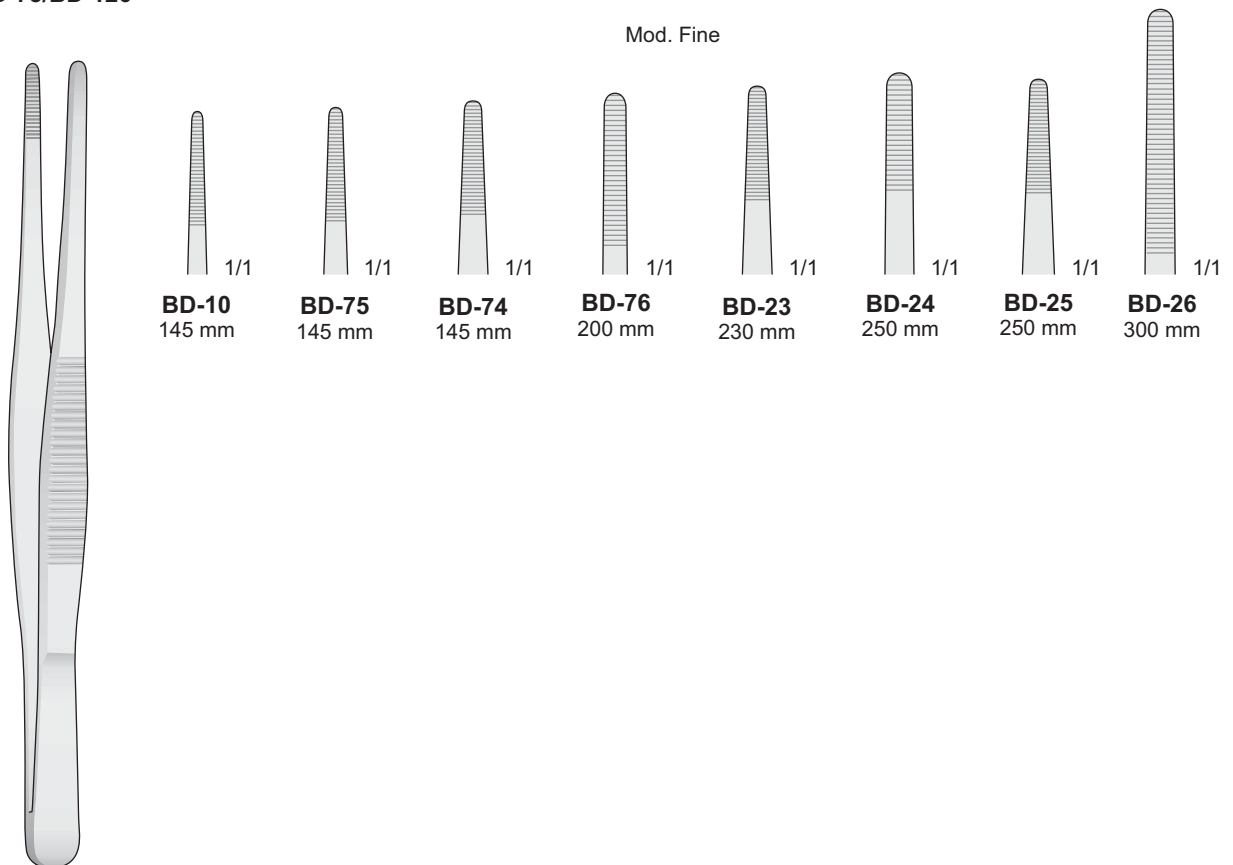

BD-10/BD-76

04

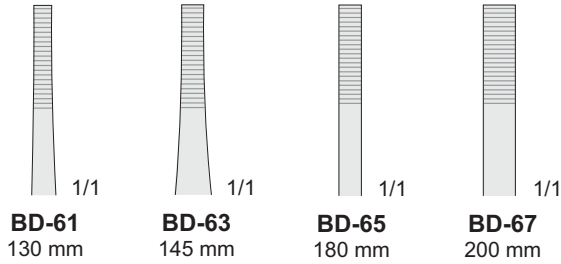

STILLE
BD-61/BD-67

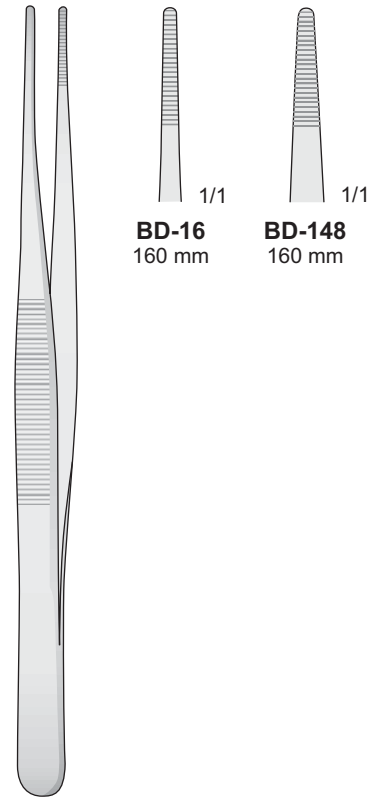

BD-16/BD-148
160 mm

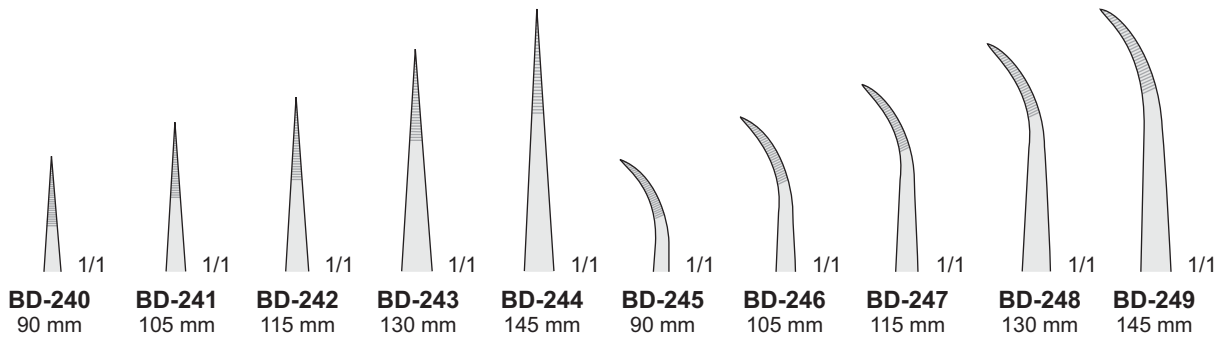

BD-240/BD-249

1 x 2 Denti - 1 x 2 Teeth - 1 x 2 Zähne - 1 x 2 Dents - 1 x 2 Dientes



Standard

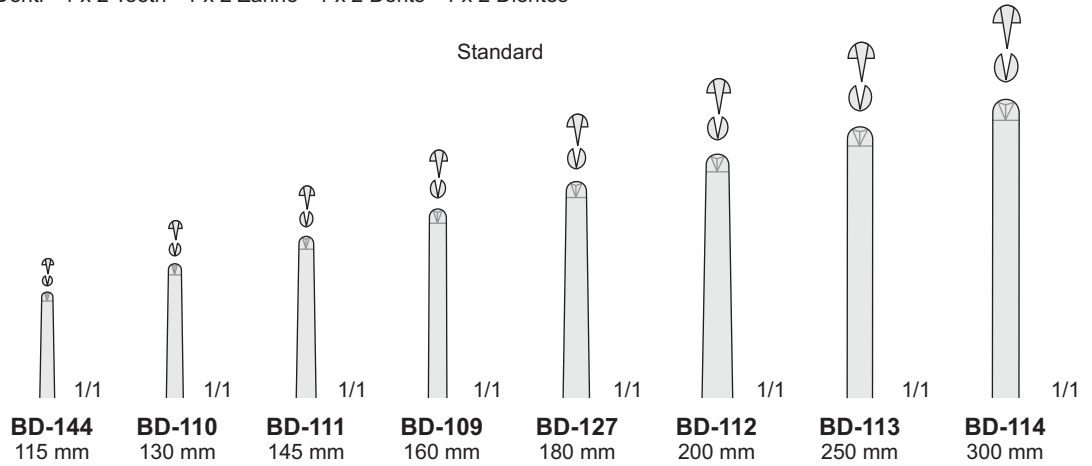

BD-109/BD-144

1 x 2 Denti - 1 x 2 Teeth - 1 x 2 Zähne - 1 x 2 Dents - 1 x 2 Dientes



Strette - Schmal - Narrow - Étroites - Estrechas

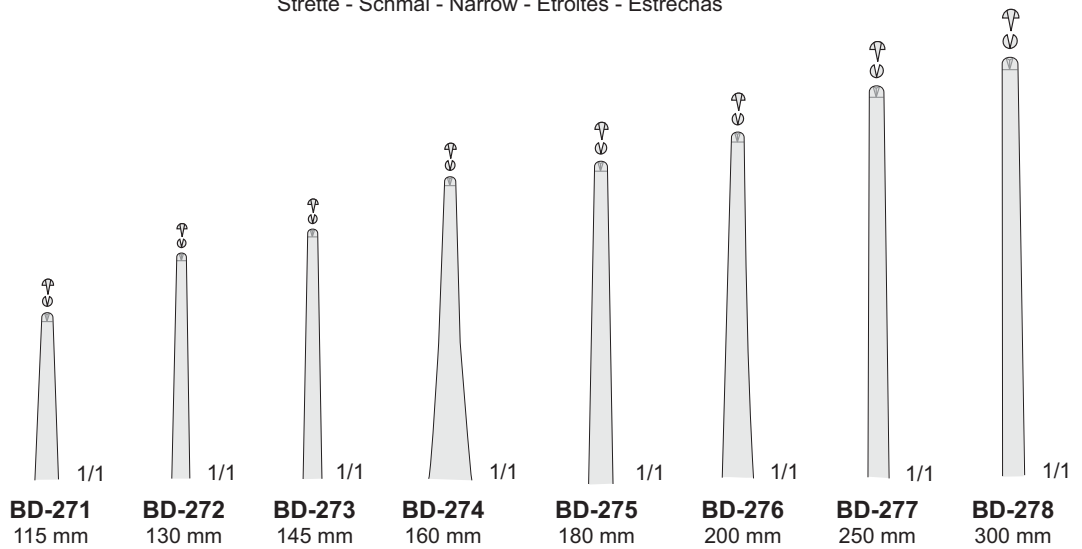

BD-271/BD-278

Strette - Schmal - Narrow - Étroites - Estrechas

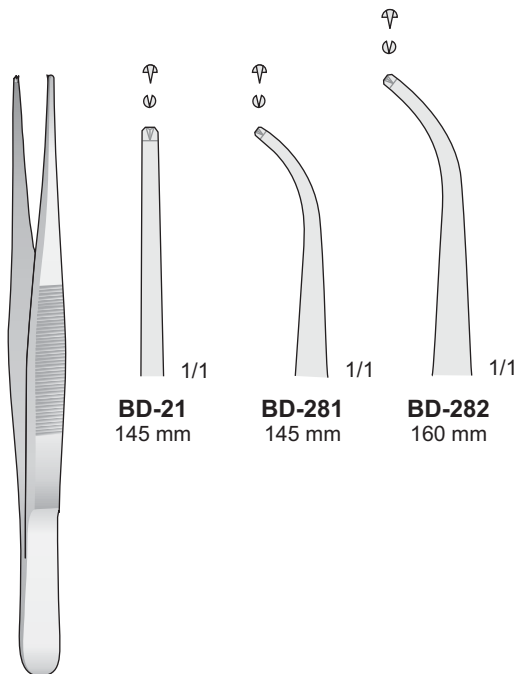

BD-21
145 mm

BD-281
145 mm

BD-282
160 mm

Fine - Delicate - Fein - Fines - Finas

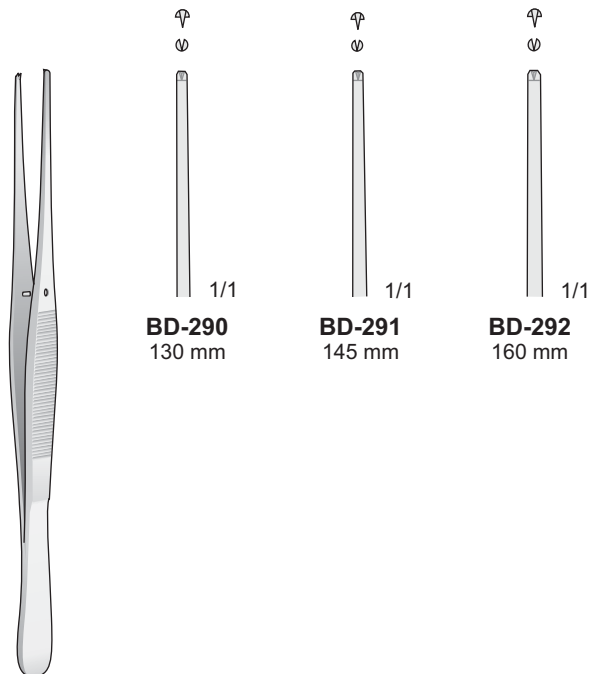

BD-290
130 mm

BD-291
145 mm

BD-292
160 mm

BD-21/BD-282

- 1 x 2 Denti
- 1 x 2 Teeth
- 1 x 2 Zähne
- 1 x 2 Dents
- 1 x 2 Dientes

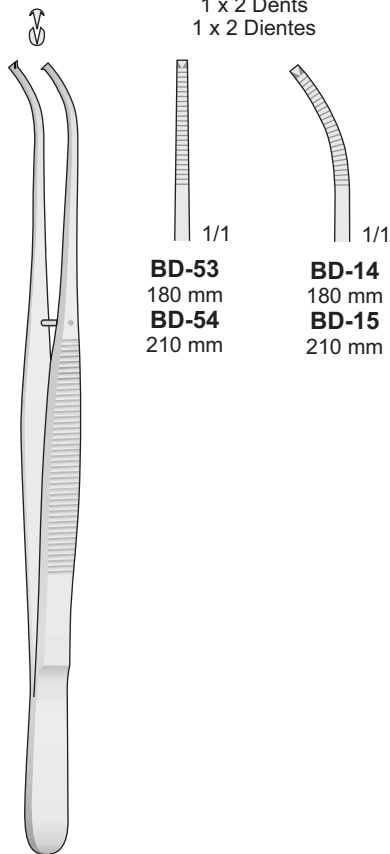

BD-53
180 mm
BD-54
210 mm

BD-14
180 mm
BD-15
210 mm

BD-290/BD-292

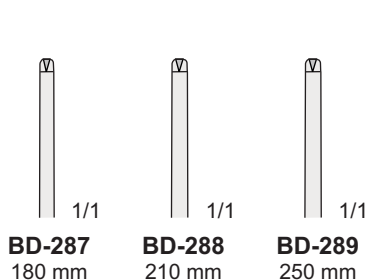

BD-287
180 mm

BD-288
210 mm

BD-289
250 mm

- 1 x 2 Denti
- 1 x 2 Teeth
- 1 x 2 Zähne
- 1 x 2 Dents
- 1 x 2 Dientes

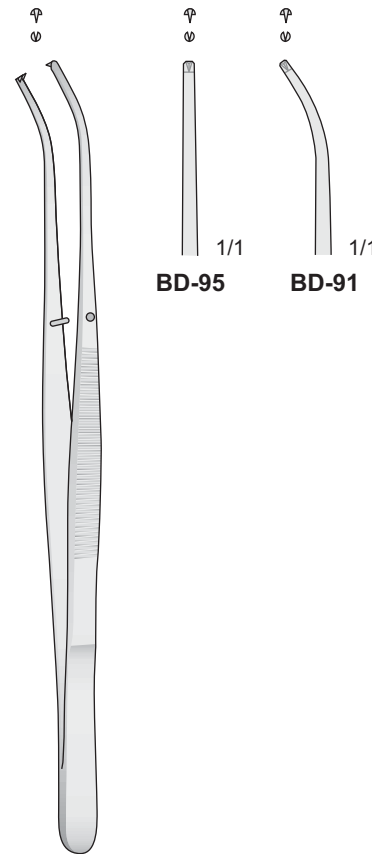

BD-95
1/1

BD-91
1/1

POTTS-SMITH
BD-14/BD-54

POTTS-SMITH
BD-287/BD-289

SEMKEN
BD-91/BD-95
150 mm

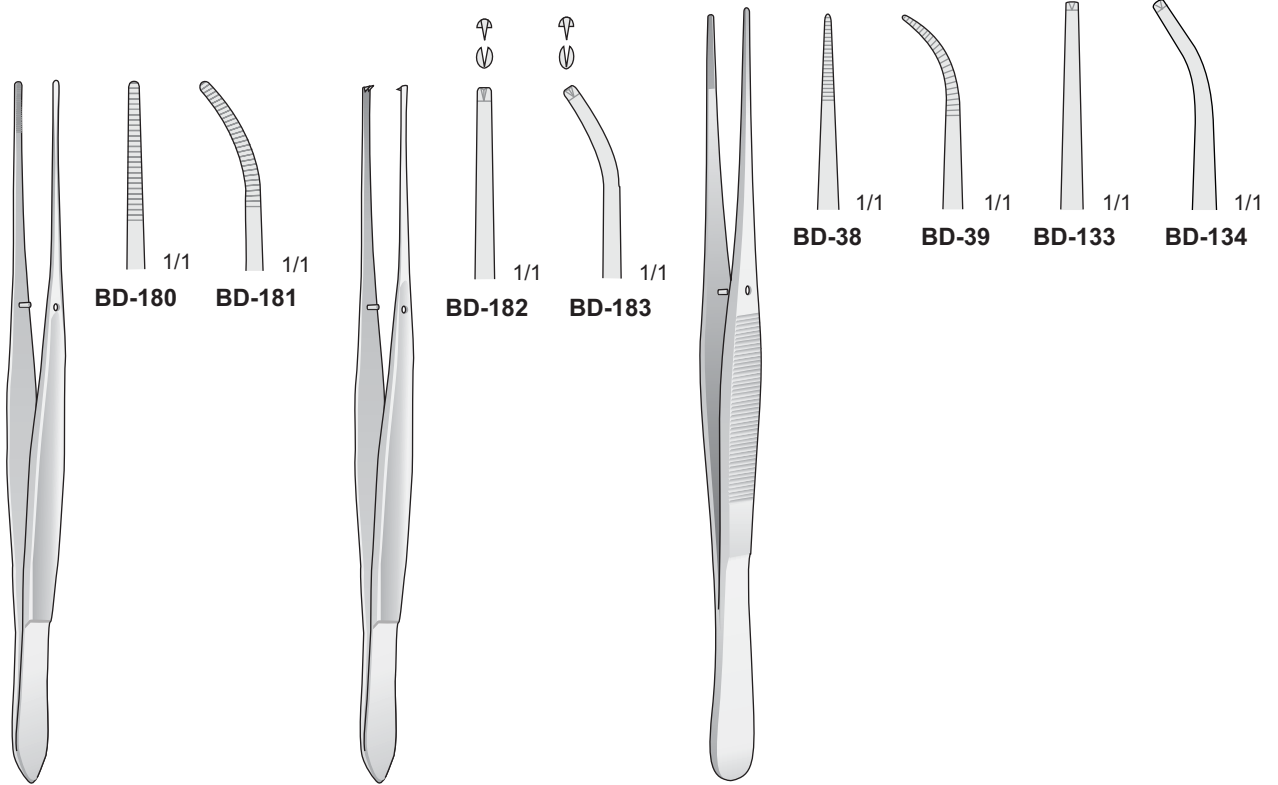

CUSHING
BD-180/BD-181
175 mm

CUSHING
BD-182/BD-183
175 mm

BD-38/BD-134
200 mm

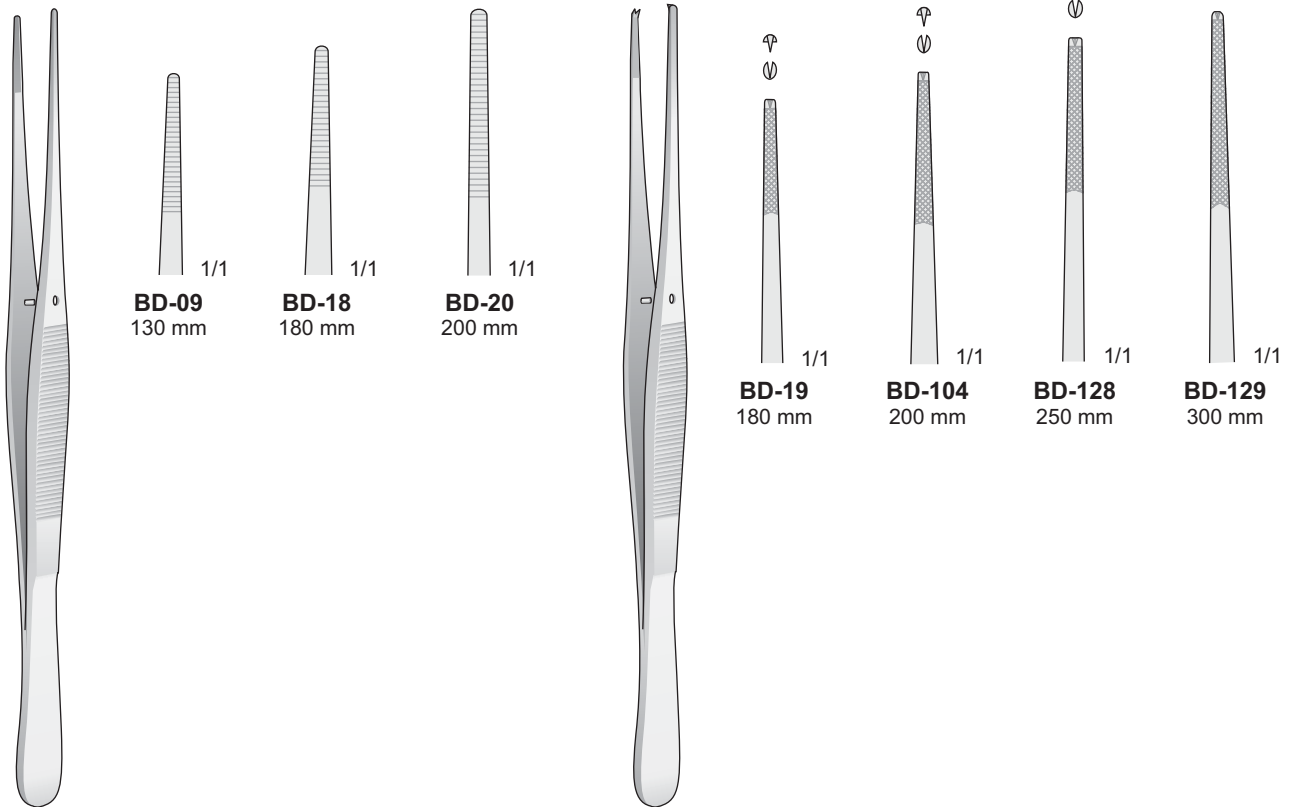





BD-09/BD-20

BD-19/BD-129

2 x 3 Denti - 2 x 3 Teeth - 2 x 3 Zähne
2 x 3 Dents - 2 x 3 Dientes







- 
 1/1
BD-106
 115 mm
- 
 1/1
BD-138
 145 mm
- 
 1/1
BD-107
 160 mm
- 
 1/1
BD-139
 180 mm
- 
 1/1
BD-108
 200 mm

BD-106/BD-139

3 x 4 Denti - 3 x 4 Teeth - 3 x 4 Zähne
3 x 4 Dents - 3 x 4 Dientes





- 
 1/1
BD-115
 145 mm
- 
 1/1
BD-119
 160 mm
- 
 1/1
BD-116
 200 mm
- 
 1/1
BD-117
 250 mm

BD-115/BD-119

4 x 5 Denti
4 x 5 Teeth
4 x 5 Zähne
4 x 5 Dents
4 x 5 Dientes



- 
 1/1
BD-118
 145 mm
- 
 1/1
BD-149
 160 mm

BD-118/BD-149

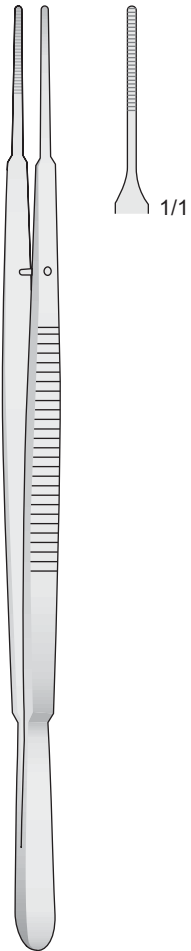

GERALD
MF-101
180 mm

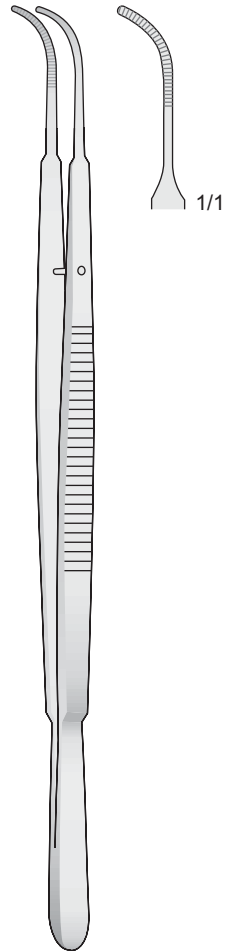

GERALD
MF-102
180 mm

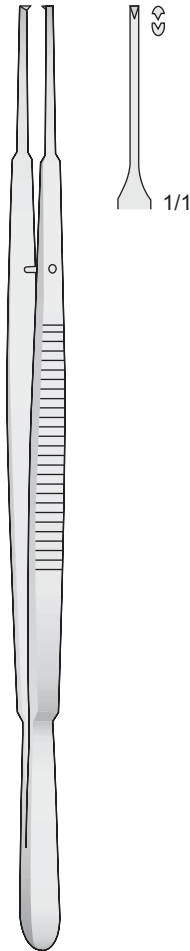

GERALD
MF-103
180 mm

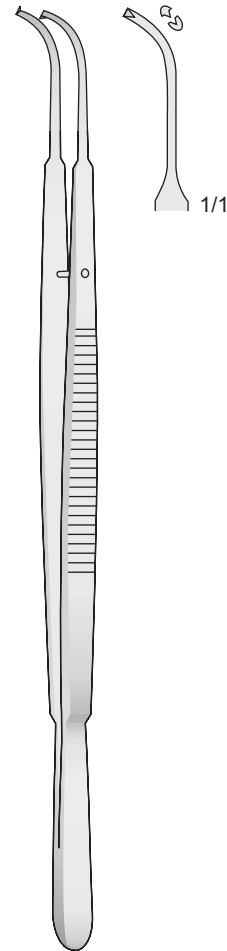

GERALD
MF-104
180 mm

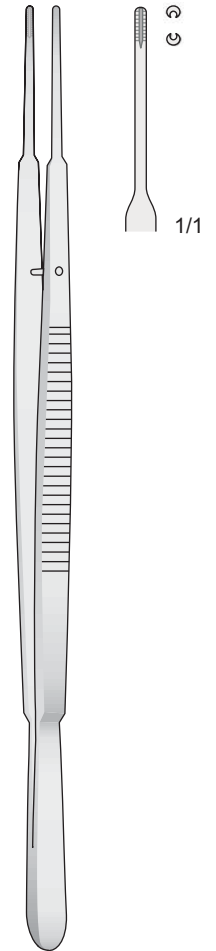

GERALD-BROWN
MF-105
180 mm

Pinzette per vasi e per tumori
Pinces vasculaires et pour tumeurs

3 x 4 Denti
3 x 4 Teeth
3 x 4 Zähne
3 x 4 Dents
3 x 4 Dientes

4 x 5 Denti
4 x 5 Teeth
4 x 5 Zähne
4 x 5 Dents
4 x 5 Dientes

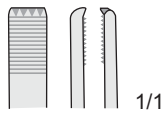

1/1

2 x 3 Denti
2 x 3 Teeth
2 x 3 Zähne
2 x 3 Dents
2 x 3 Dientes

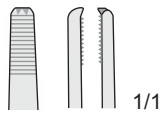

1/1



1/1

BD-17
180 mm



1/1

BD-184
200 mm



1/1

BD-185
250 mm

ADLERKREUTZ
BD-28 - 150 mm
BD-155 - 200 mm
BD-156 - 250 mm

ADLERKREUTZ
BD-153 - 150 mm
BD-154 - 200 mm

STILLE-BARRAYA
BD-17/BD-185



DURANTE
BD-151/BD-152

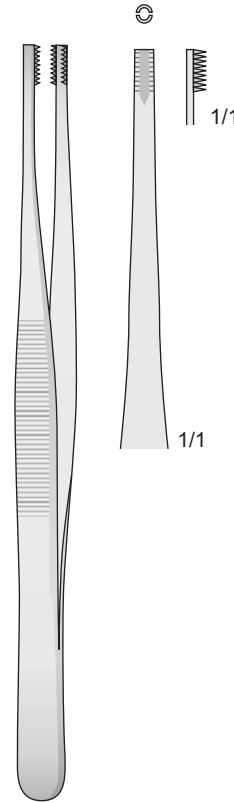
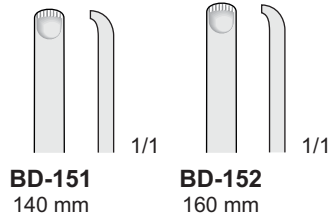

BROWN
BD-94
150 mm

8 x 8 Denti
8 x 8 Teeth
8 x 8 Zähne
8 x 8 Dents
8 x 8 Dientes

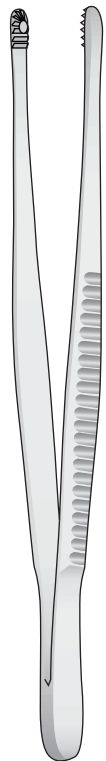

RUSSIAN
BD-27/BD-176

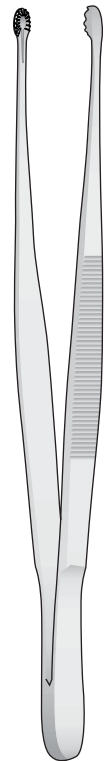
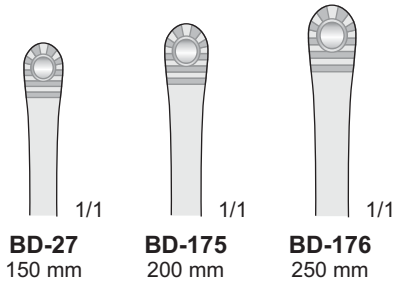

SELMAN
BD-157
150 mm



SINGLEY-TUTTLE
BD-29
230 mm

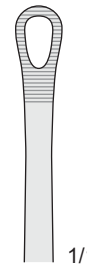

MAYO-RUSSIAN
BD-37
230 mm

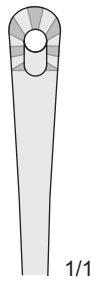

04

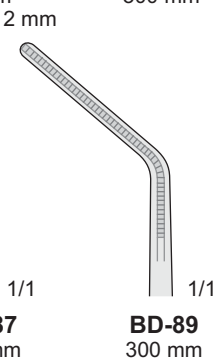
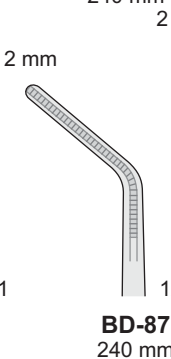
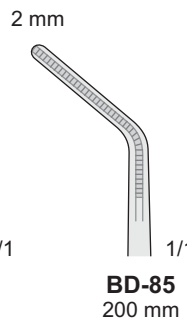
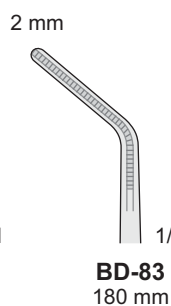
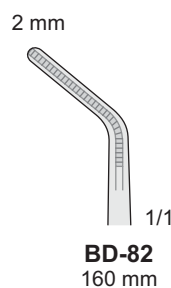
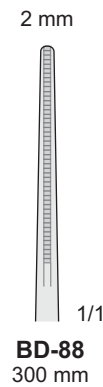
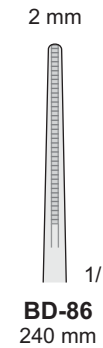
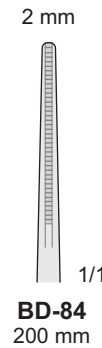
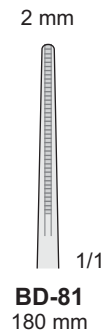
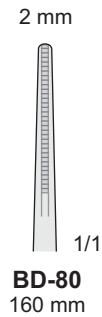
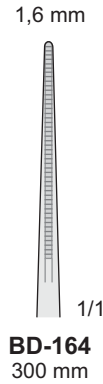
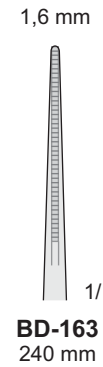
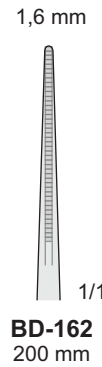
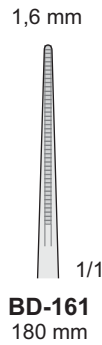
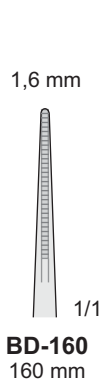
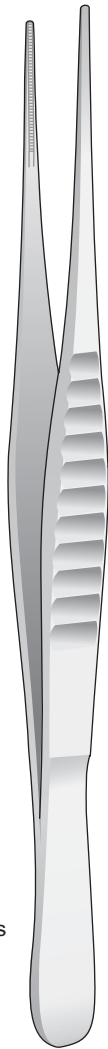
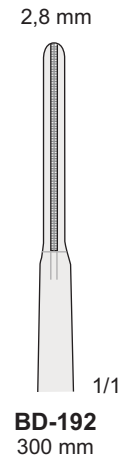
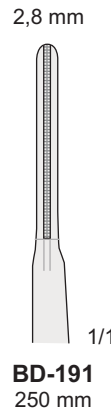
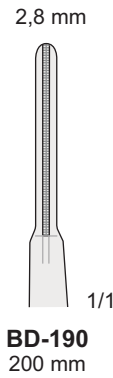
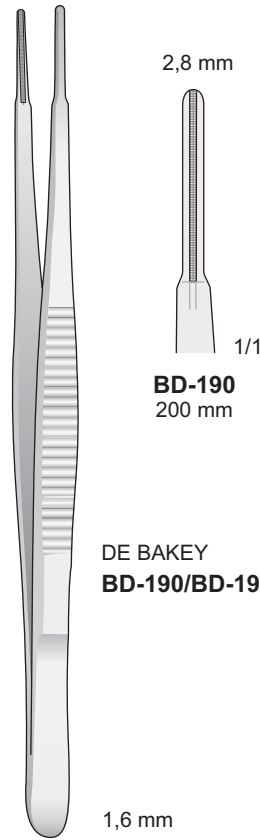
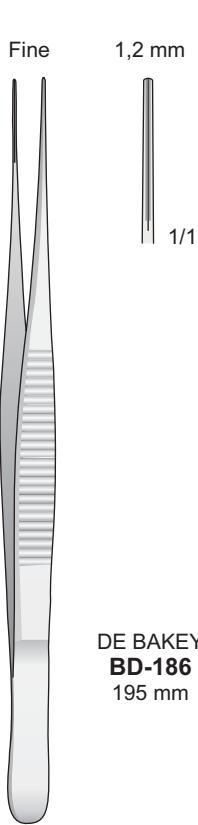

Pinzette atraumatiche
Non-traumatic vascular tissue forceps
Atraumatische pinzetten
Pincas atraumaticas
Pinzas atraumaticas

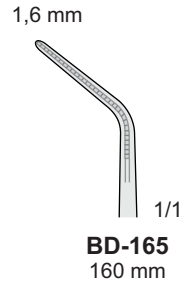

Pinzette atraumatiche
Atraumatische pinzetten
Atraumatic vascular tissue forceps
Pincés atraumatiques
Pinzas atraumaticas

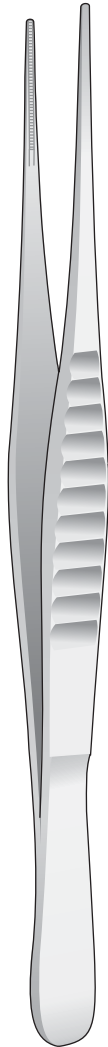

DE BAKEY
BD-165/BD-173

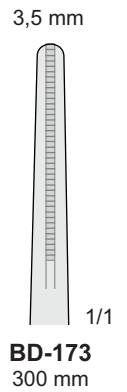
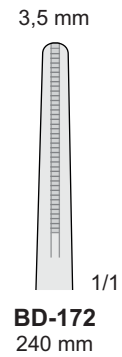
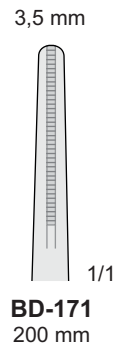
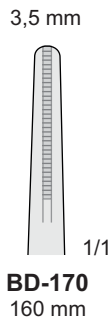
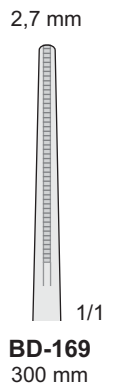
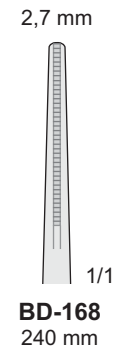
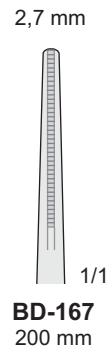
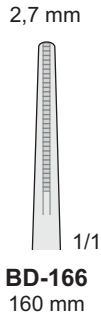

Pinze da Fissazione-oftalmica - Fixier und fasspinzetten
Fixation and Grasping forceps - Pinzas de fijación y de aprehensión

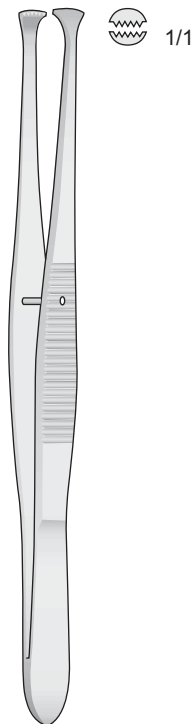

GRAEFE
BD-135
110 mm

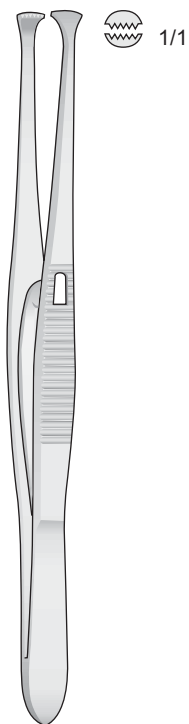

GRAEFE
BD-136
110 mm

Pinzetta-Columella
con stop

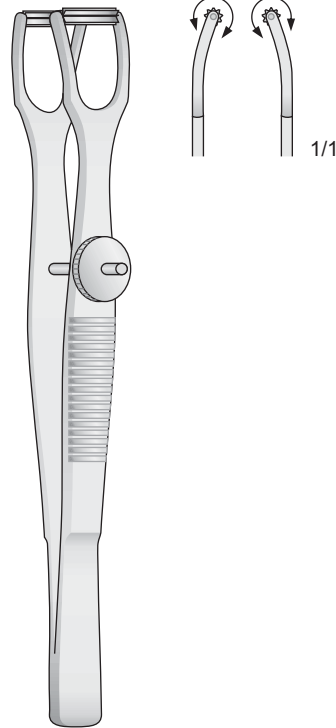

COTTLE
BD-140
100 mm

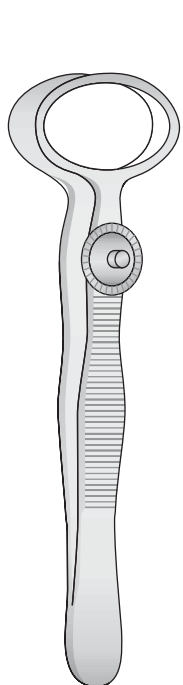

DESMARRES
BD-130/BD-132
90 mm

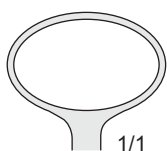

BD-130
20 mm

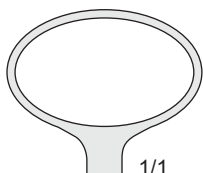

BD-131
26 mm

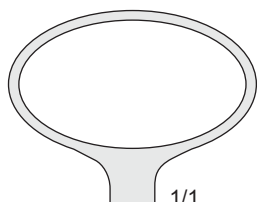

BD-132
31 mm

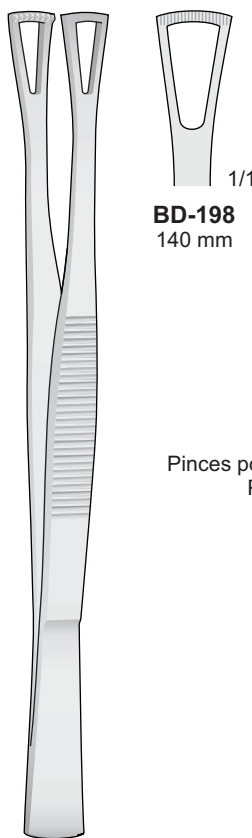

DUVAL
BD-198/BD-199

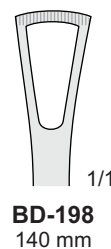

BD-198
140 mm

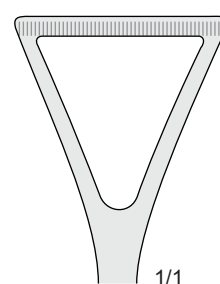

BD-199
200 mm

Pinze intestinali
Intestinal forceps
Darmpinzetten
Pincés pour préhension de l'intestin
Pinzas intestinales



Con punta al carburo di tungsteno - Tungsten-carbide forceps
Mit Hartmetalleinsätzen - Avec plaquettes en carbure de tungstène - Pinzas con tungsteno

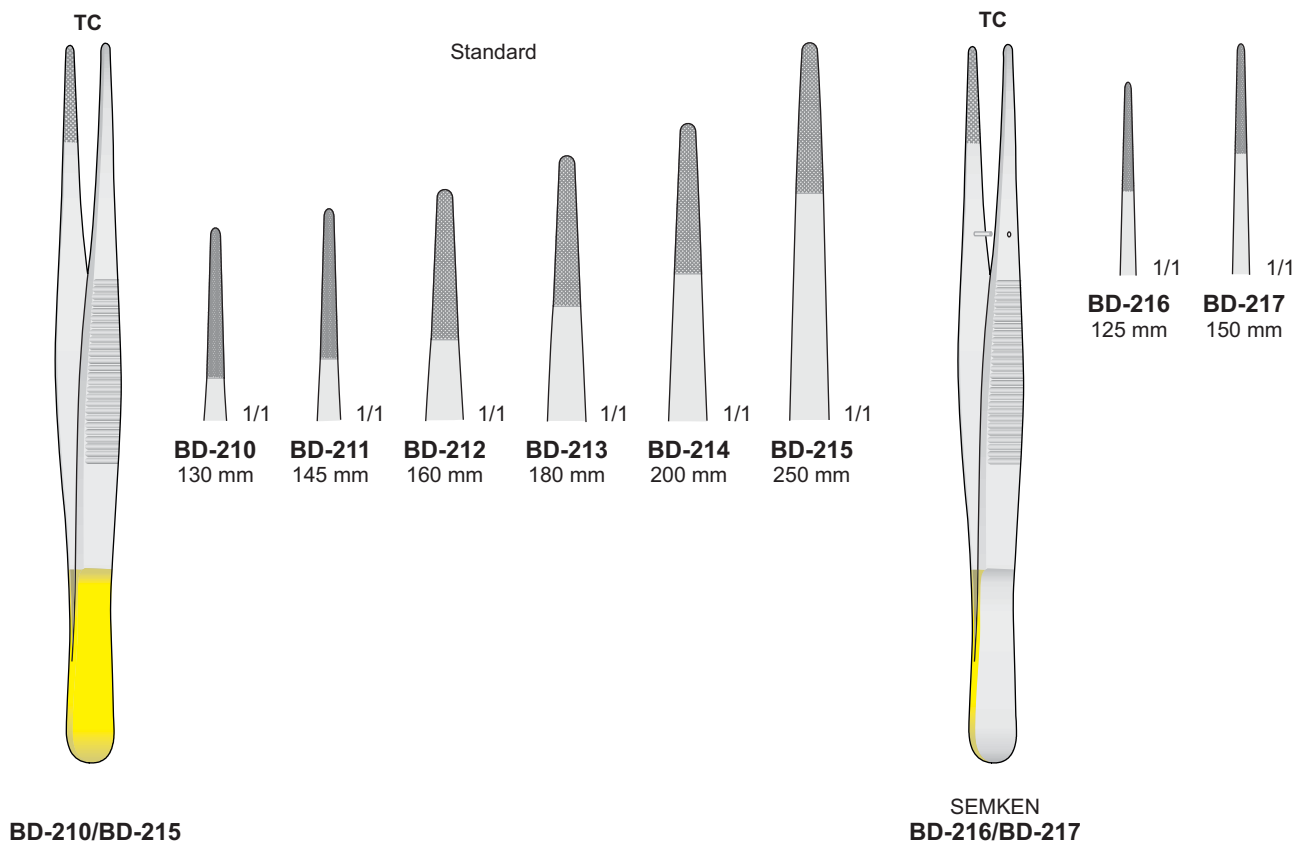
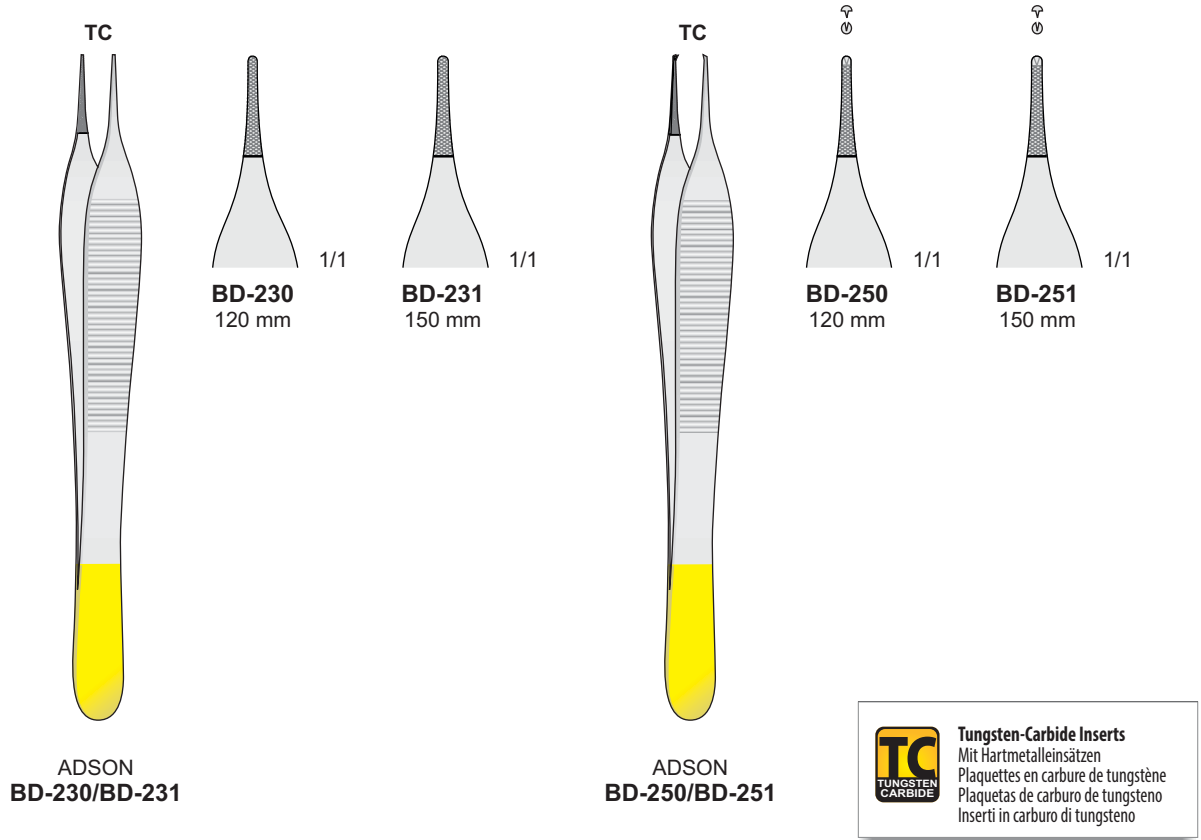

TC

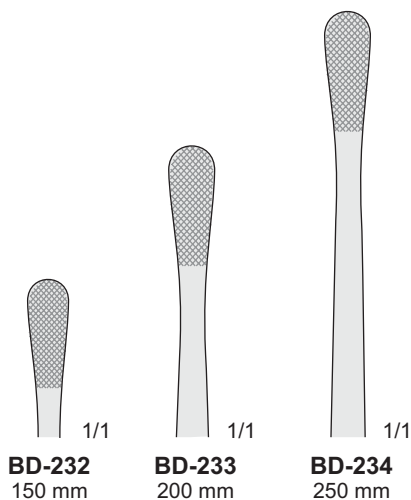

BD-232
150 mm

BD-233
200 mm

BD-234
250 mm

TC
TUNGSTEN CARBIDE
Tungsten-Carbide Inserts
Mit Hartmetalleinsätzen
Plaquettes en carbure de tungstène
Plaquetas de carburo de tungsteno
Inserti in carburo di tungsteno

WANGENSTEEN
BD-232/BD-234

TC

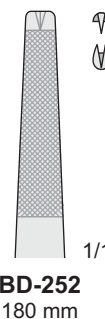

BD-252
180 mm

BONNEY
BD-252
180 mm

TC

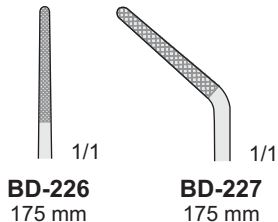

BD-226
175 mm

BD-227
175 mm

Con dissettore
With Dissector End
Mit Dissektor-Ende
Avec bout disecteur
Con cabo disecador

CUSHING
BD-226/BD-227
175 mm

TC

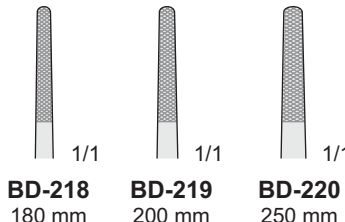

BD-218
180 mm

BD-219
200 mm

BD-220
250 mm

Con dissettore
With Dissector End
Mit Dissektor-Ende
Avec bout disecteur
Con cabo disecador

POTTS-SMITH
BD-218/BD-220

TC

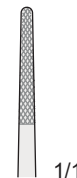

Con dissettore
With Dissector End
Mit Dissektor-Ende
Avec bout disecteur
Con cabo disecador

TAYLOR
BD-228
185 mm

Con punta al carburo di tungsteno
 Tungsten-carbide forceps
 Mit hartmetalleinsätzen
 Avec plaquettes en carbure de tungstène
 Pinzas con tungsteno

TC

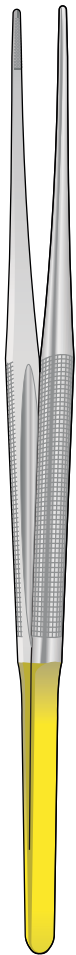

DE BAKEY
MF-320
 180 mm

TC



BD-221/BD224

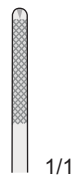

BD-221
 145 mm

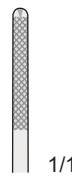

BD-222
 160 mm

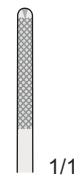

BD-223
 180 mm

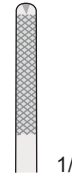

BD-224
 200 mm

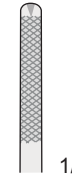

BD-225
 250 mm

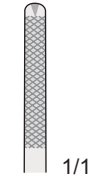

BD-229
 300 mm



Tungsten-Carbide Inserts
 Mit Hartmetalleinsätzen
 Plaquettes en carbure de tungstène
 Plaquetas de carburo de tungsteno
 Inserti in carburo di tungsteno

04

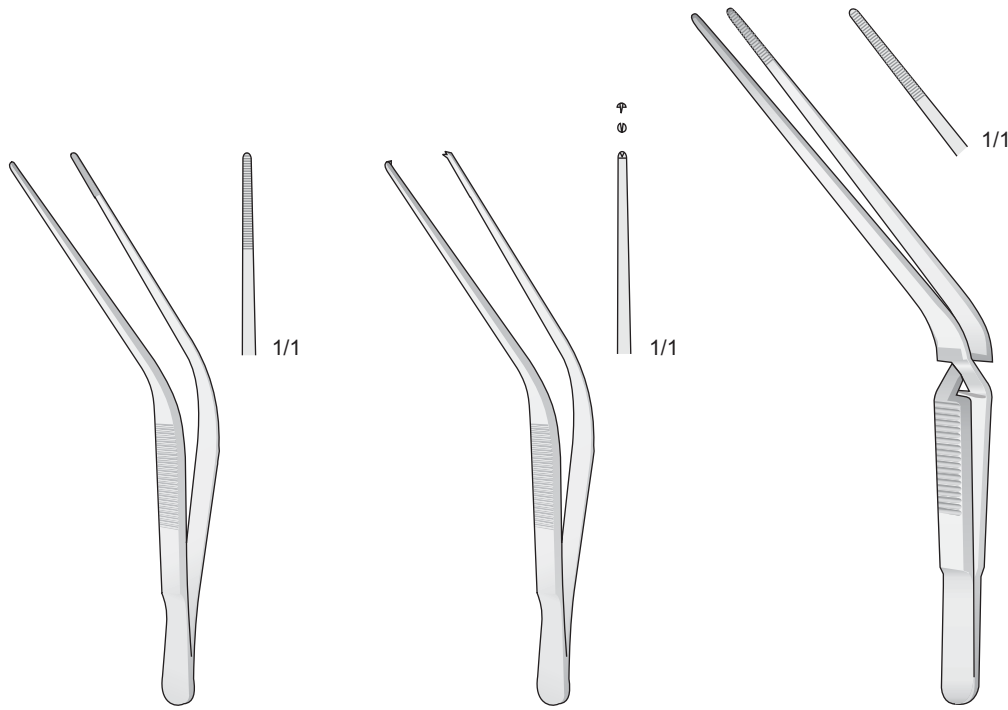

TROELTSCH
BD-22
110 mm

TROELTSCH
BD-146
110 mm

TROELTSCH
BD-179
130 mm

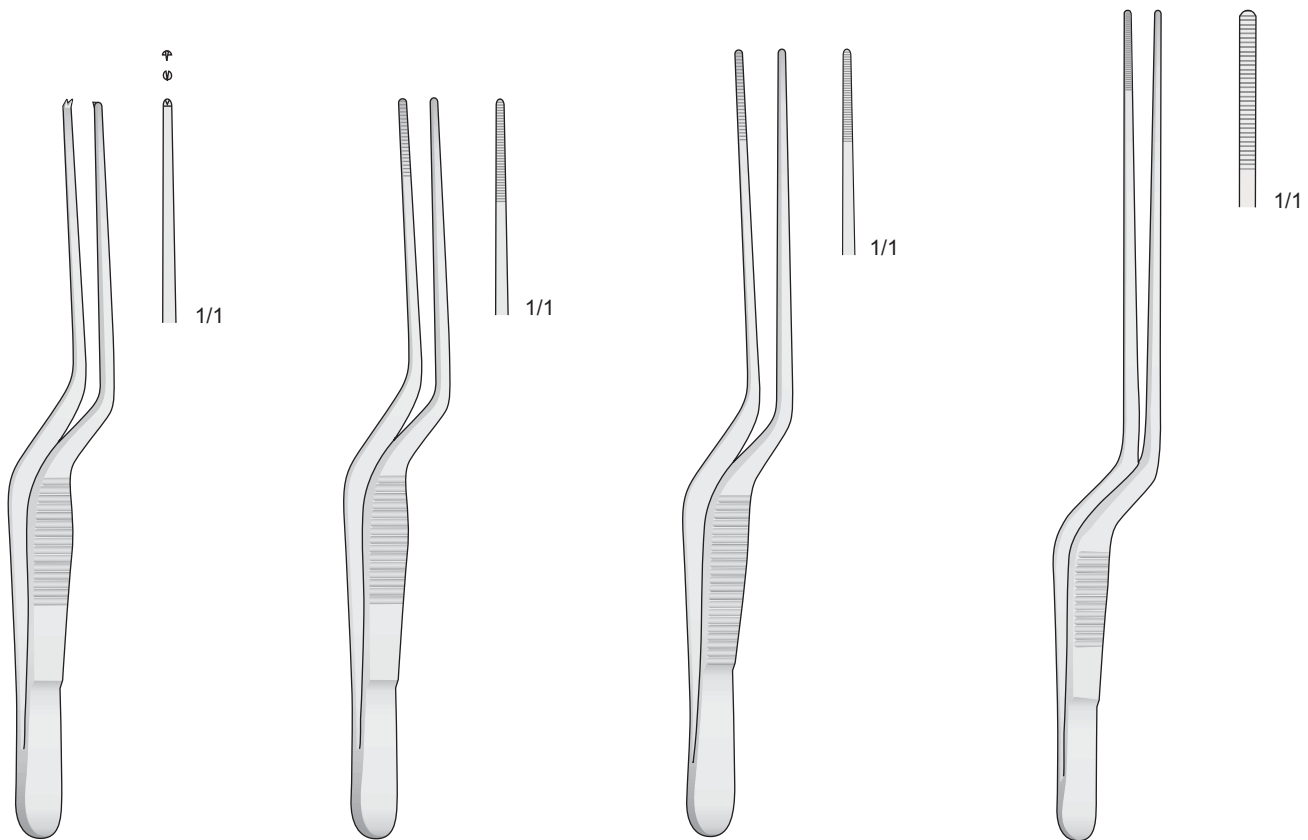

LUCAE
BD-147
140 mm

LUCAE
BD-101
140 mm

JANSEN
BD-102
160 mm

GRÜNWARD
BD-193
200 mm



HUNTER
BD-120/BD-174



BD-120
105 mm



BD-174
105 mm



FEICHENFELD
BD-121
75 mm

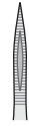

1/1



FEICHENFELD
BD-122
90 mm



1/1



FEICHENFELD
BD-123
115 mm

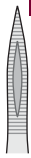

1/1

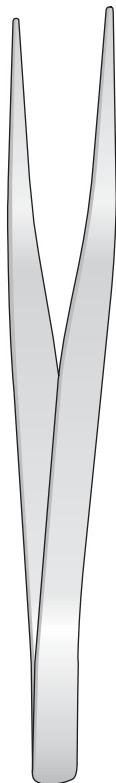

BD-50
150 mm

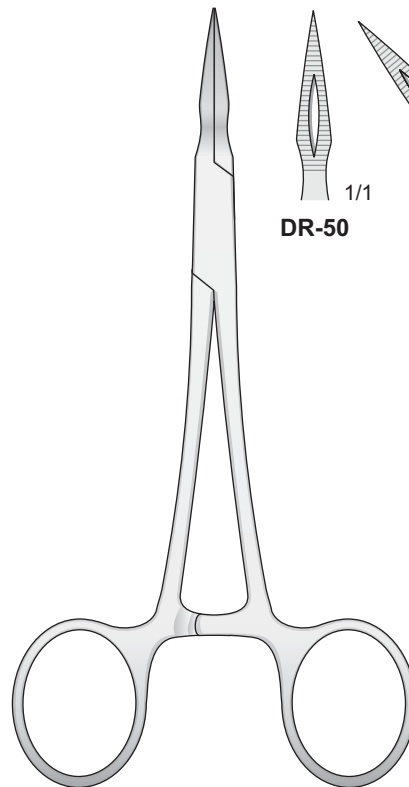

STIEGLITZ
DR-50/DR-60
140 mm



DR-50
1/1

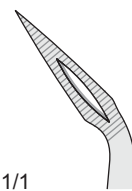

DR-60
1/1

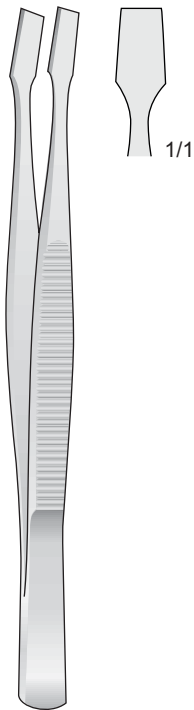

KÜHNE
ES-44
105 mm

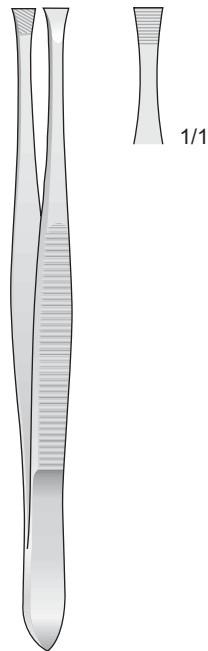

LITTAUER
ES-64
85 mm

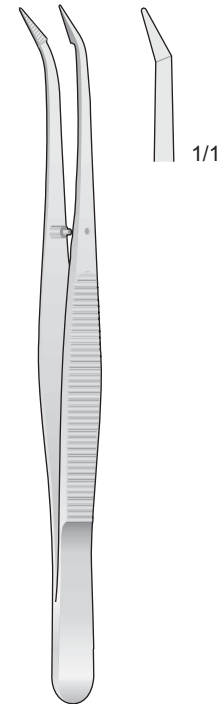

BARRAQUER
ES-65
105 mm

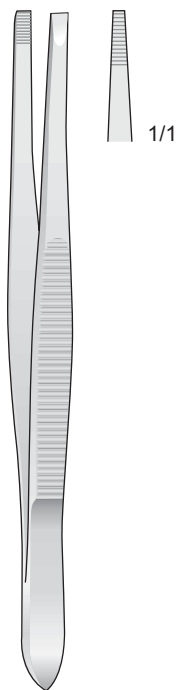

ES-45
90 mm

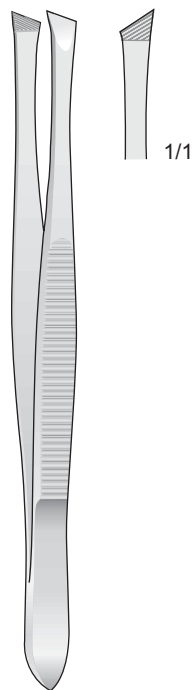

ES-46
90 mm

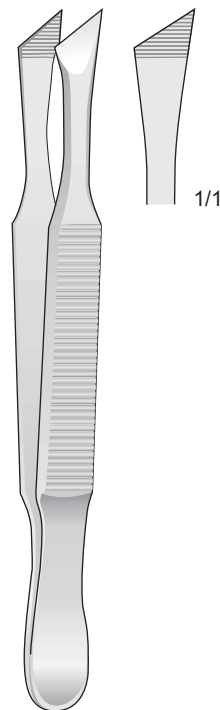

BERGH
ES-47
105 mm

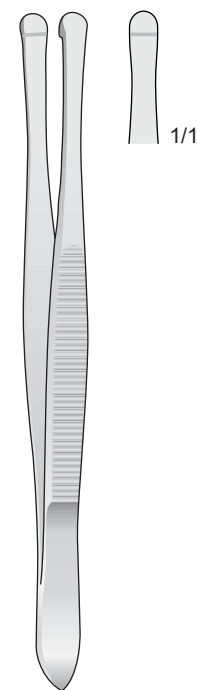

BEER
ES-48
90 mm

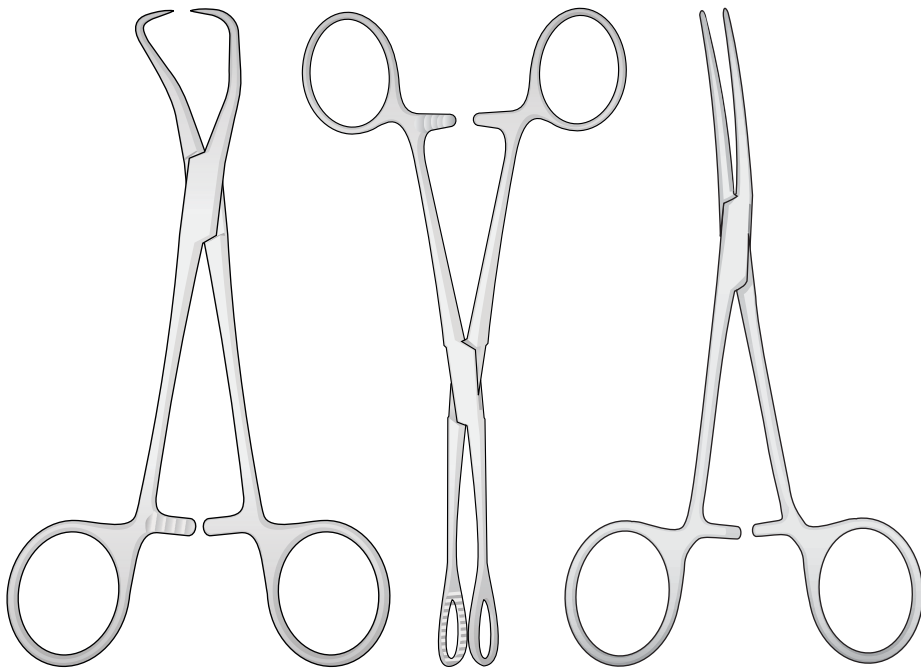

05

Hemostatic Forceps | Towel Clamps
Arterienklemmen | Tuchklemmen
Pincés hémostatiques | Pincés à champs
Pinzas hemostáticas | Pinzas de campo
Pinzette emostatiche | Fissateli

05



Pinze Sinus
Sinus forceps
Sinus klemmen
Pinces à Sinus
Pinzas para seno

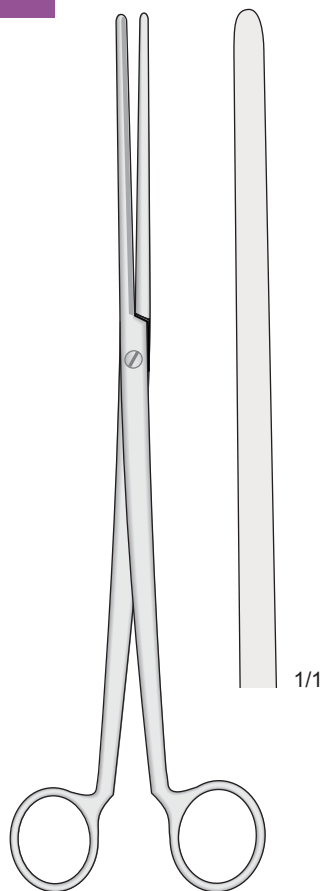

**COLLIN
BF-03**
260 mm

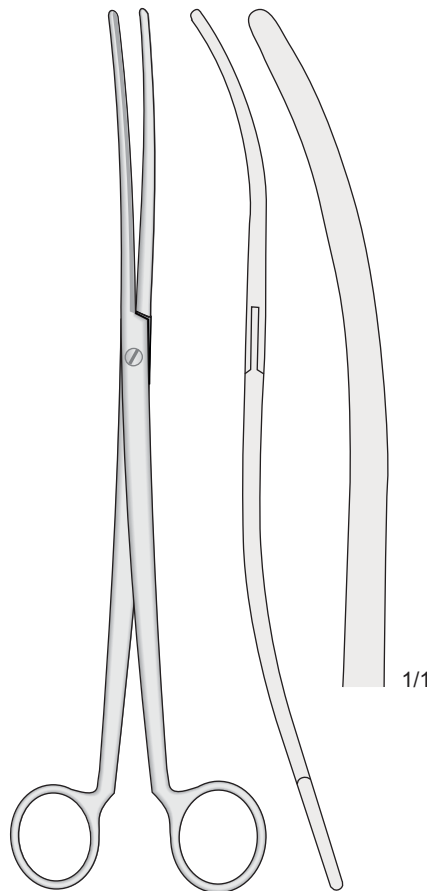

**COLLIN
BF-04**
260 mm

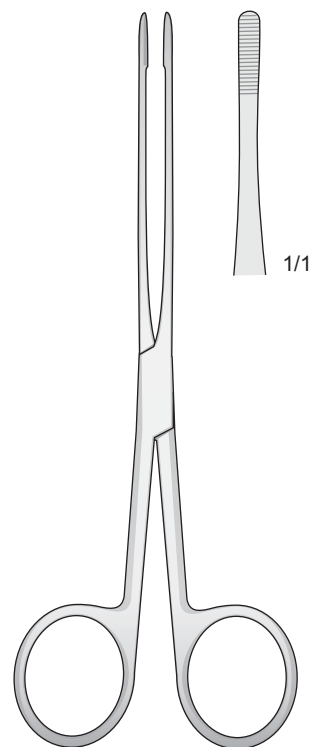

**LISTER
BF-20**
150 mm

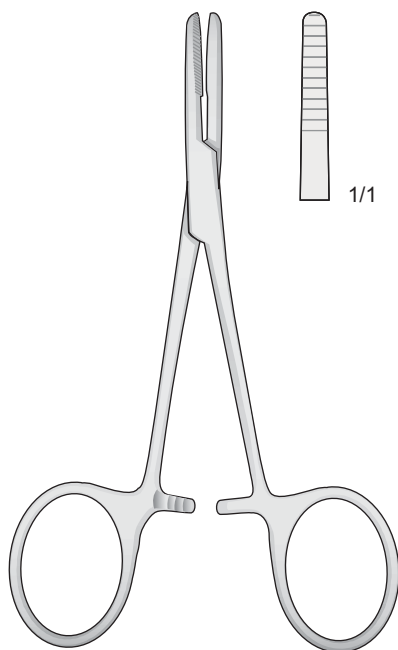

**TERRIER
P-60**
130 mm

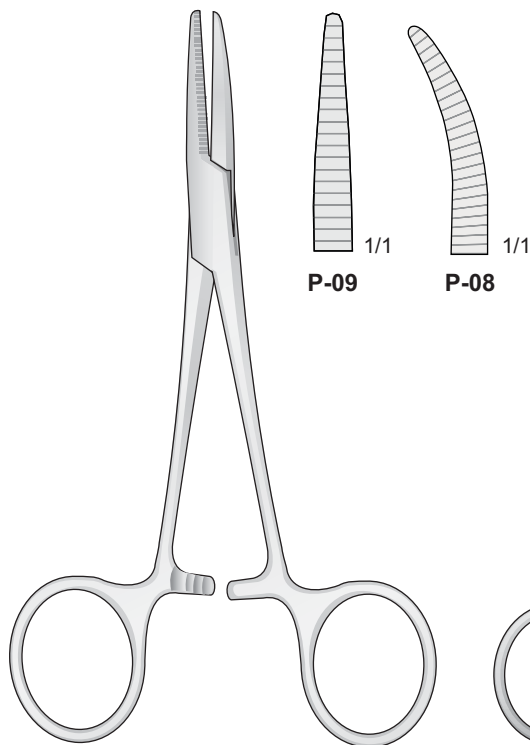

**JONES
P-09/P-08**
150 mm

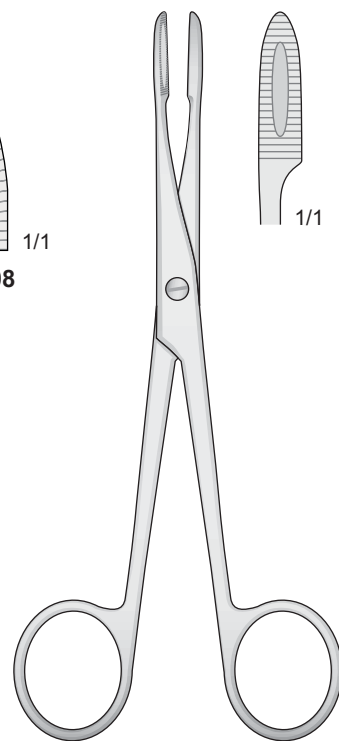

**GROSS
BF-10 - 130 mm
BF-12 - 160 mm**

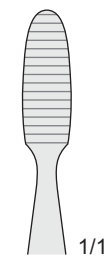
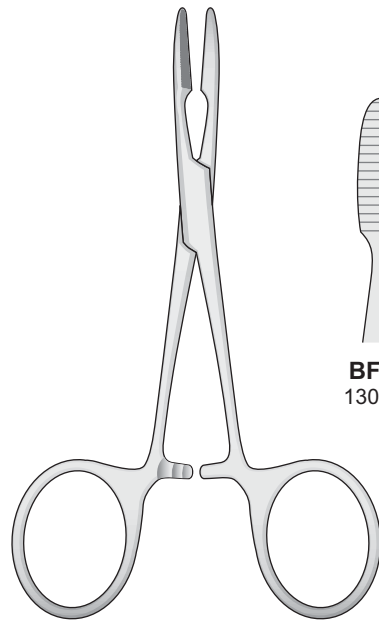

BF-22
130 mm

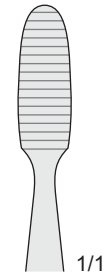

BF-24
140 mm

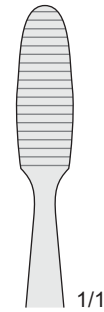

BF-26
150 mm

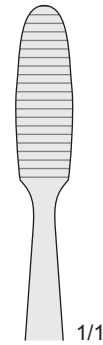

BF-28
160 mm

PEAN-MURPHY
BF-22/BF-28

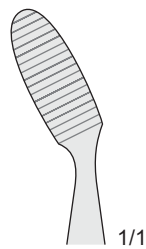
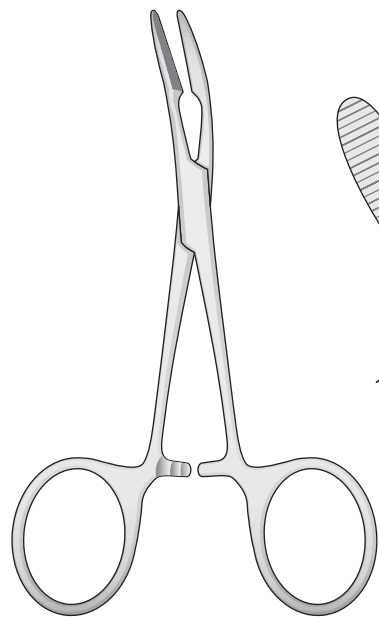

BF-23
130 mm

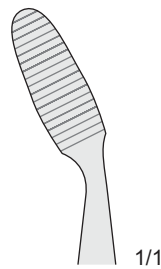

BF-25
140 mm

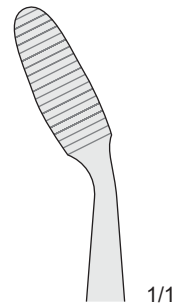

BF-27
150 mm

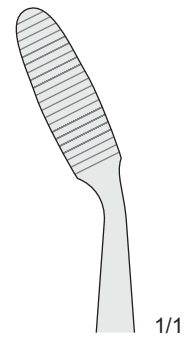

BF-29
160 mm

PEAN-MURPHY
BF-23/BF-29

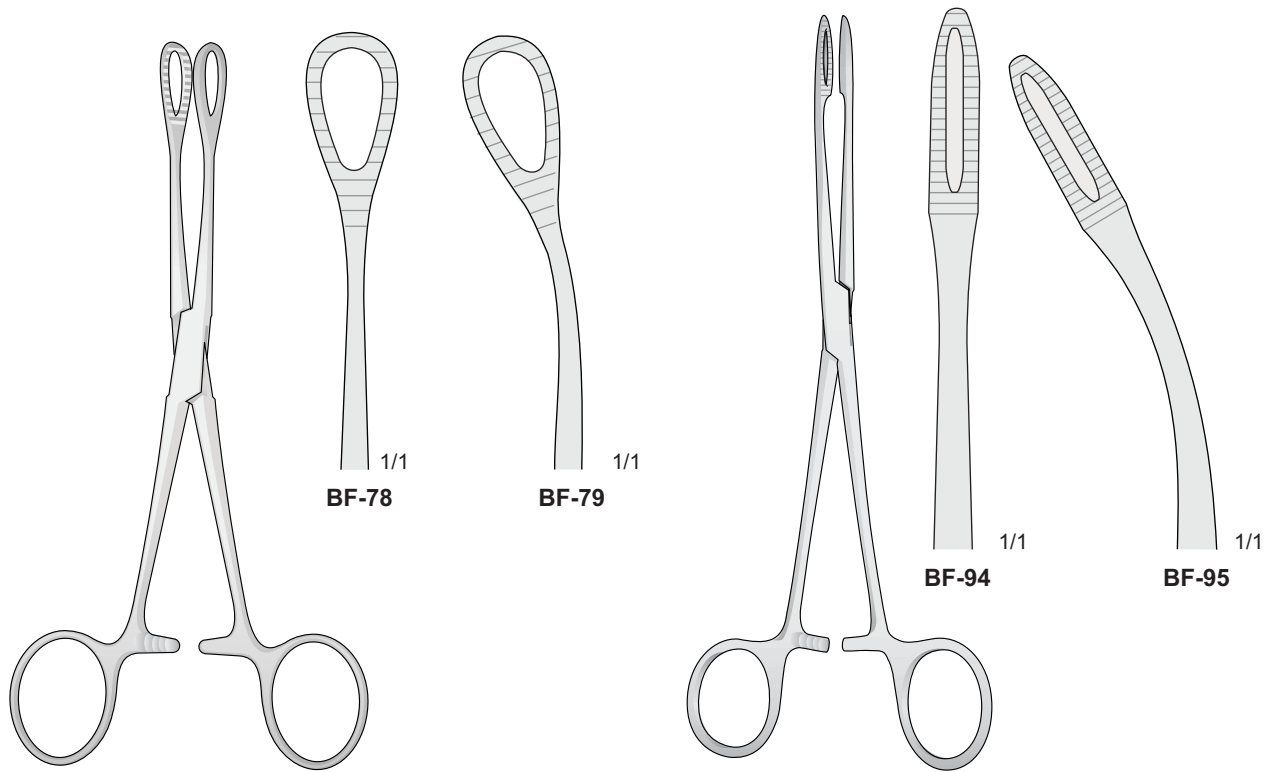

FOERSTER-BALLENGER
BF-78/BF-79
180 mm

GROSS
BF-94/BF-95
200 mm

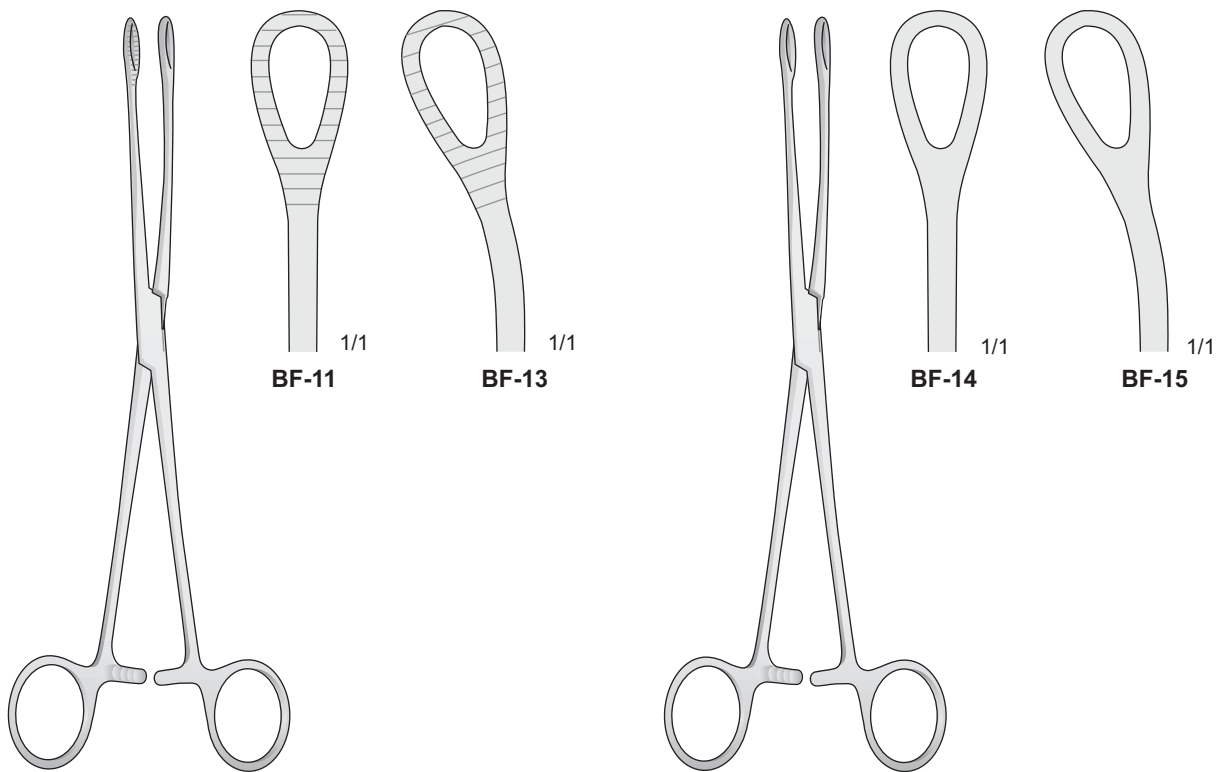

FOERSTER-BALLENGER
BF-11/BF-13
240 mm

FOERSTER-BALLENGER
BF-14/BF-15
240 mm

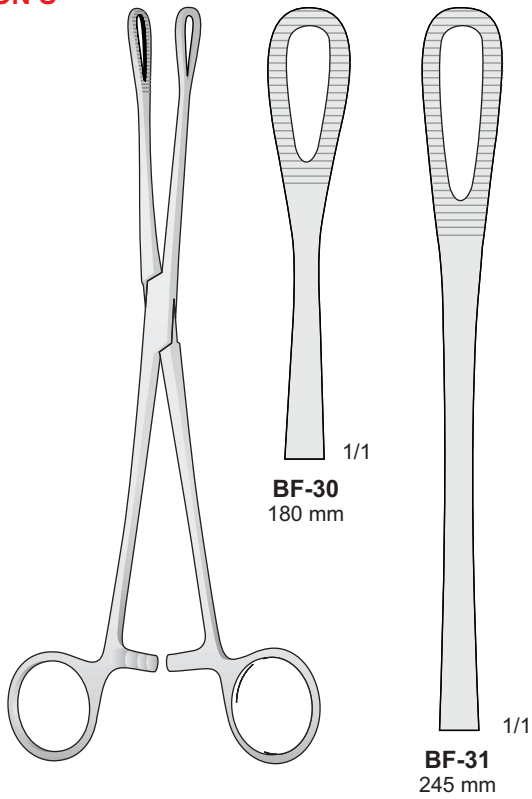

RAMPLEY
BF-30/BF-31

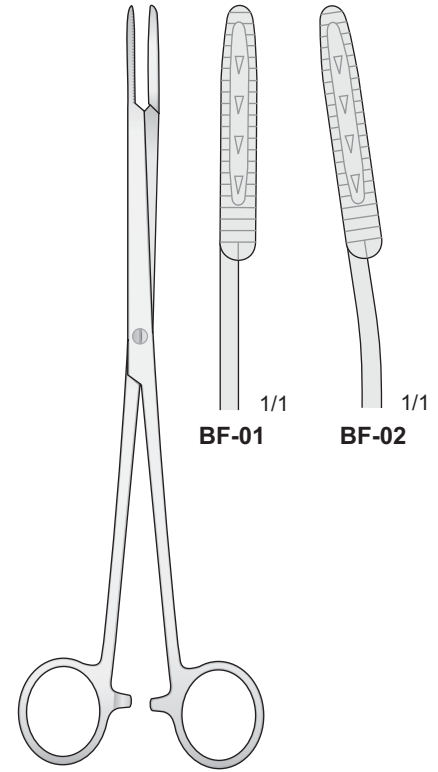

MAIER
BF-01/BF-02
245 mm

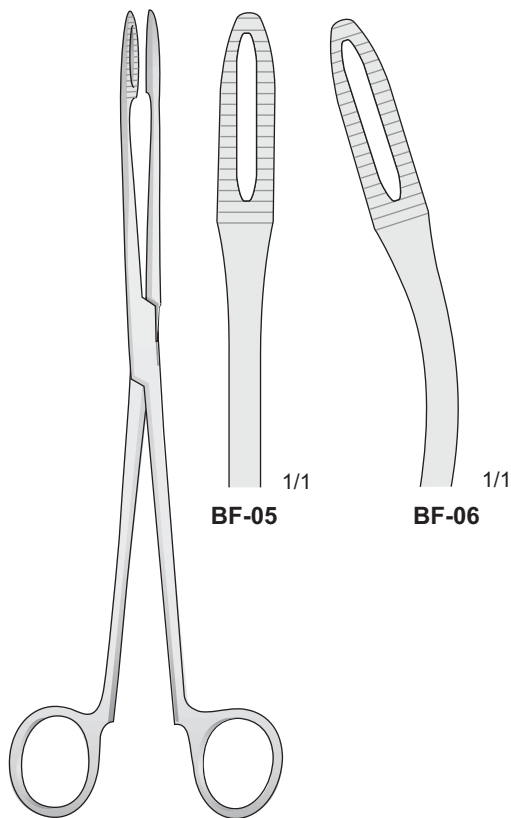

MAIER
BF-05/BF-06
265 mm

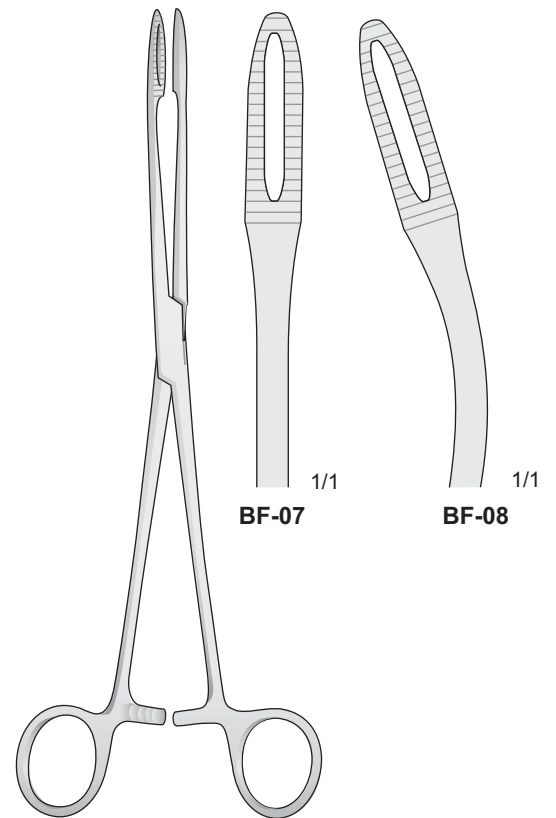

MAIER
BF-07/BF-08
265 mm

Gommini di ricambio 2 pezzi - Pair, Rubber jaws, only
 Paar, Gummipolster, Allein - Paire, mors en caotchouc, seuls
 Par, Bocas de goma, sueltas

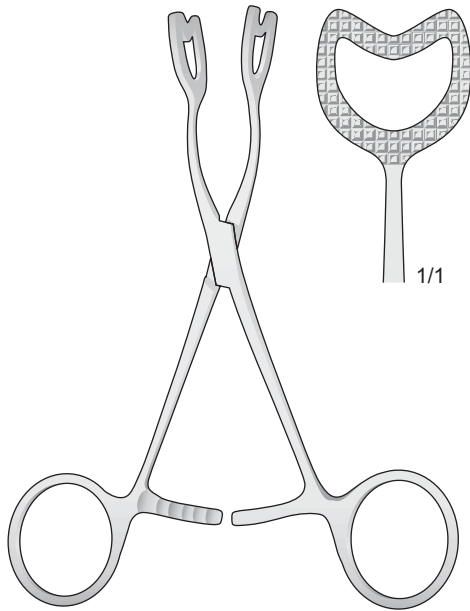

OM-11
140 mm

Gommini di ricambio 2 pezzi - Pair, Rubber jaws, only
 Paar, Gummipolster, Allein - Paire, mors en caotchouc, seuls
 Par, Bocas de goma, sueltas

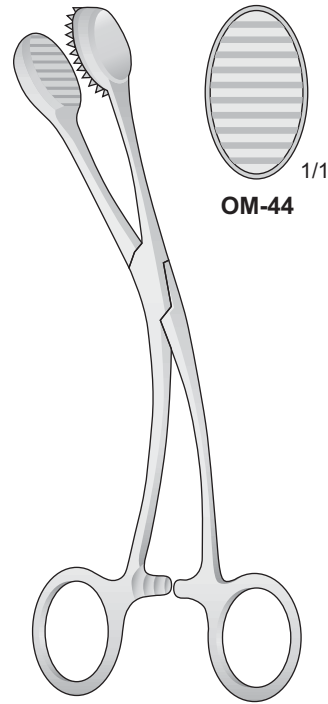

YOUNG OM-45
160 mm

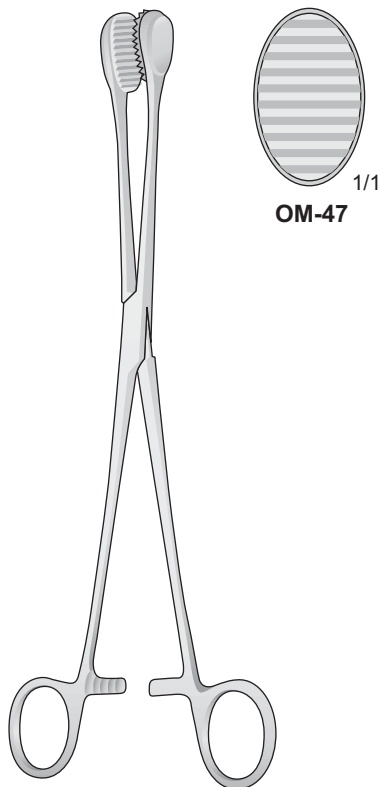

CHILD OM-46

240 mm

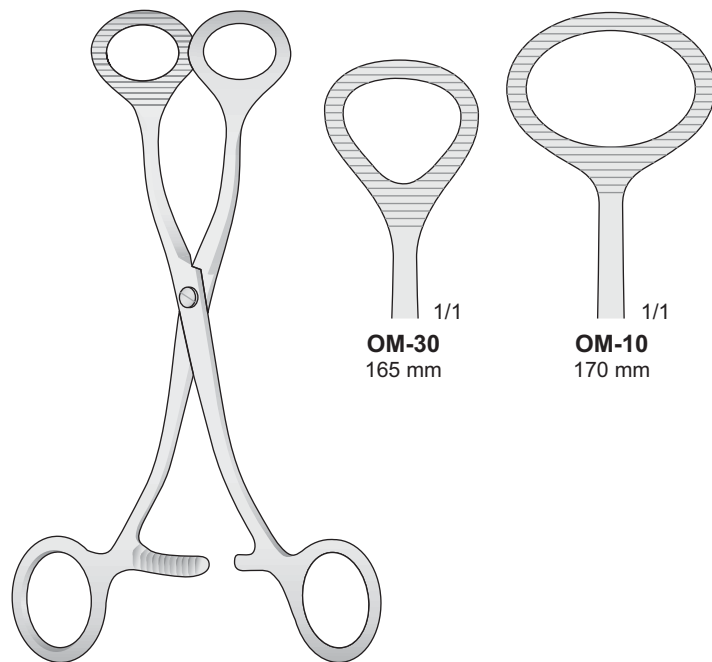

COLLIN OM-10/OM-30

Pinza per batuffoli e tamponi
Cotton swab-sponge holding forceps
Tupfer-Schwammzangen - Pinces à tampons et éponges
Pinzas para tampones porta esponjas

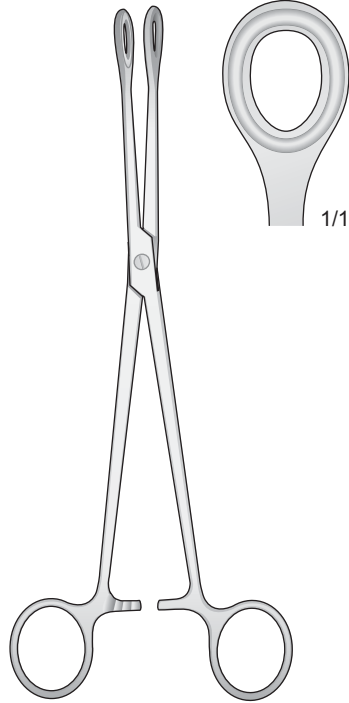

BF-16
230 mm

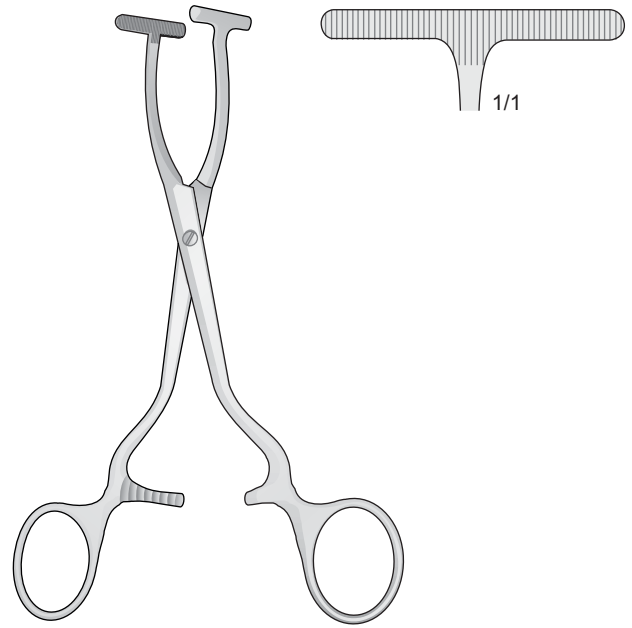

P-207
150 mm

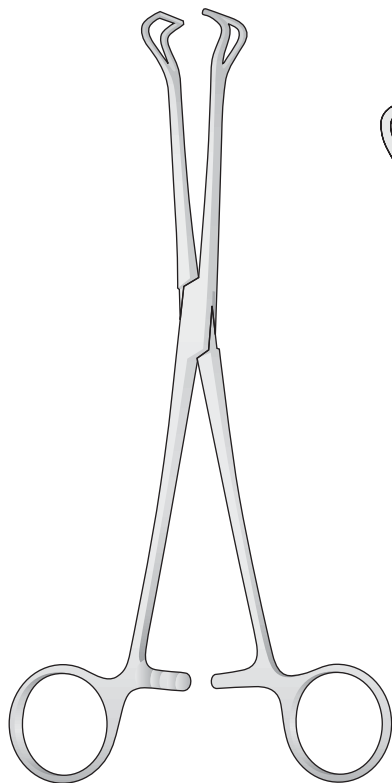

BABCOCK
P-103/P-114

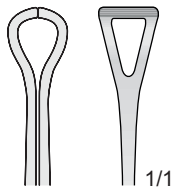

P-103
155 mm

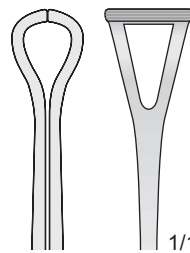

P-113
180 mm

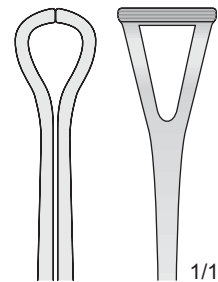

P-114
240 mm

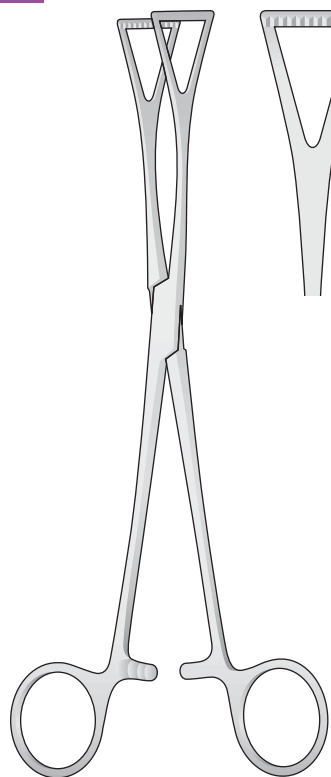

**DUVAL
P-99**
185 mm

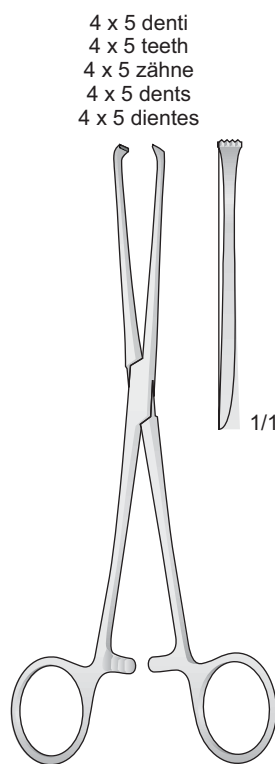
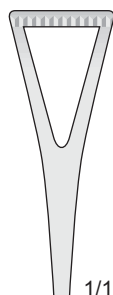

**BABY-ALLIS
P-100**
130 mm

4 x 5 denti
4 x 5 teeth
4 x 5 zähne
4 x 5 dents
4 x 5 dientes

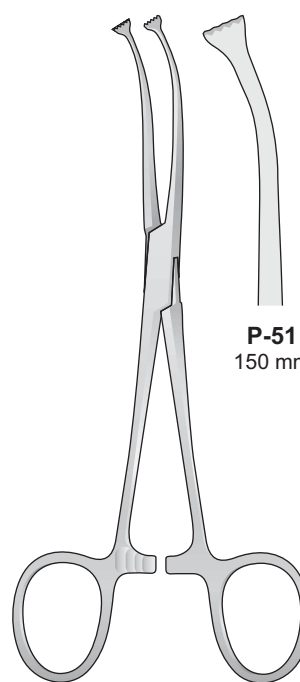

**ALLIS
P-51/P-53**

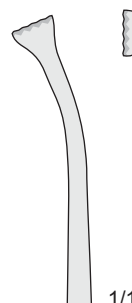

P-51
150 mm



P-53
145 mm

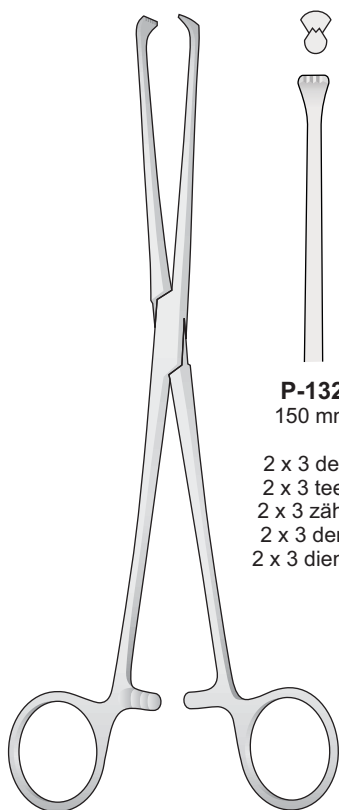

**ALLIS
P-50/P-118**

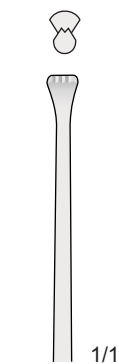

P-132
150 mm

2 x 3 denti
2 x 3 teeth
2 x 3 zähne
2 x 3 dents
2 x 3 dientes

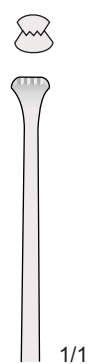

P-133
150 mm

3 x 4 denti
3 x 4 teeth
3 x 4 zähne
3 x 4 dents
3 x 4 dientes

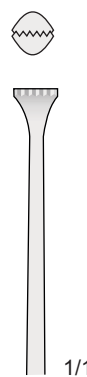

P-134
150 mm

4 x 5 denti
4 x 5 teeth
4 x 5 zähne
4 x 5 dents
4 x 5 dientes

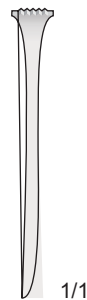

P-50
160 mm

5 x 6 denti
5 x 6 teeth
5 x 6 zähne
5 x 6 dents
5 x 6 dientes



P-115
200 mm

5 x 6 denti
5 x 6 teeth
5 x 6 zähne
5 x 6 dents
5 x 6 dientes

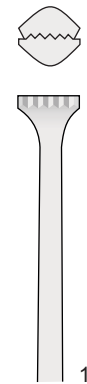

P-119
220 mm

5 x 6 denti
5 x 6 teeth
5 x 6 zähne
5 x 6 dents
5 x 6 dientes

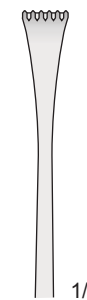

P-118
250 mm

5 x 6 denti
5 x 6 teeth
5 x 6 zähne
5 x 6 dents
5 x 6 dientes

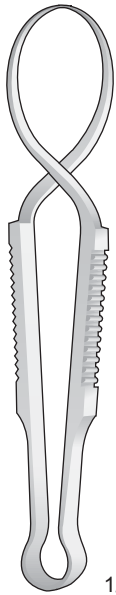

1/1

SCHAEFFEL
BF-38
85 mm

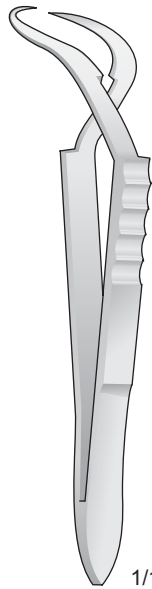

1/1

JONES
BF-48
90 mm

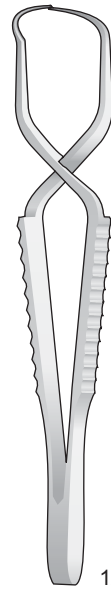

1/1

FAURE
BF-40
85 mm

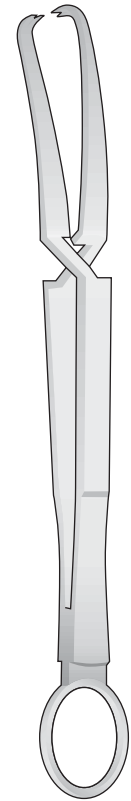

1/1

DOYEN
BF-36
180 mm

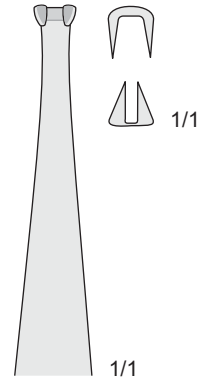

1/1

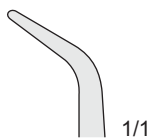

1/1

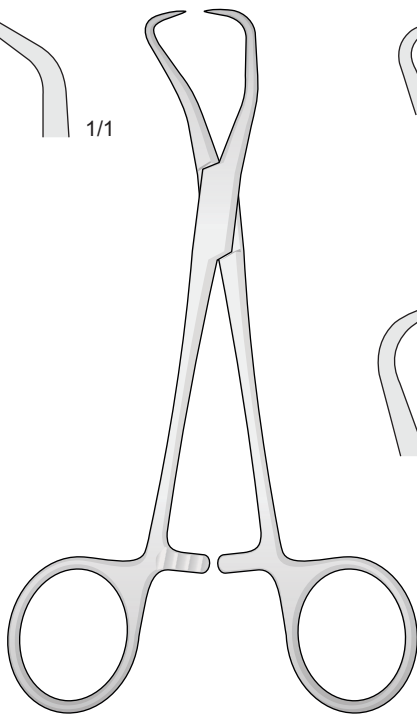

BACKHAUS
BF-42/BF-46

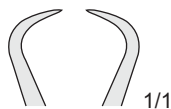

1/1

BF-42
90 mm

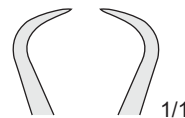

1/1

BF-41
100 mm

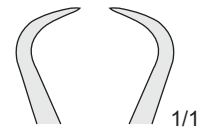

1/1

BF-44
110 mm

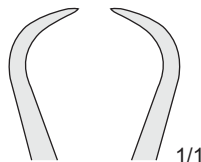

1/1

BF-46
130 mm

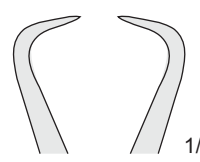

1/1

BF-43
135 mm

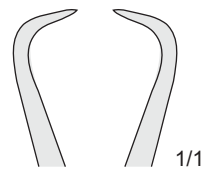

1/1

BF-45
140 mm

05

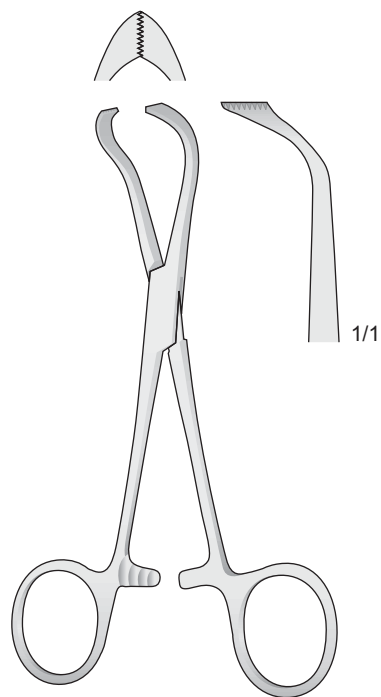

LORNA
BF-50
100 mm

Per teli di carta
For paper cloths
Für Papiertücher
Pour Champs en papier

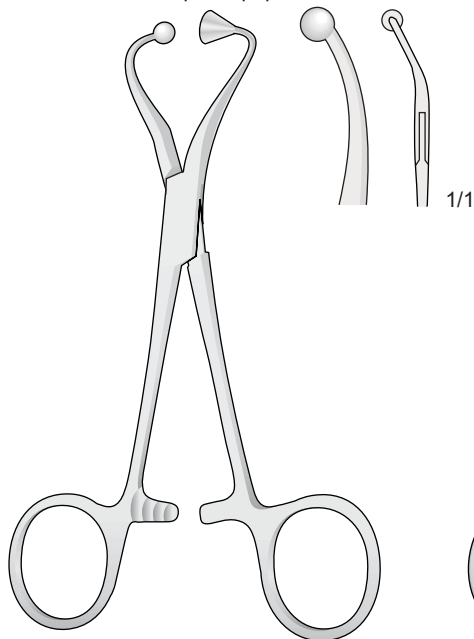

BF-74
115 mm

Per teli di carta
For paper cloths
Für Papiertücher
Pour Champs en papier

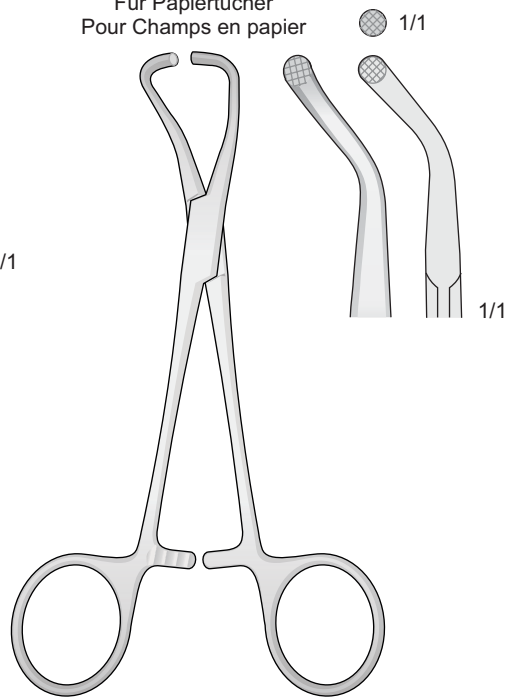

BF-52
130 mm

Per teli di carta
For paper cloths
Für Papiertücher
Pour Champs en papier

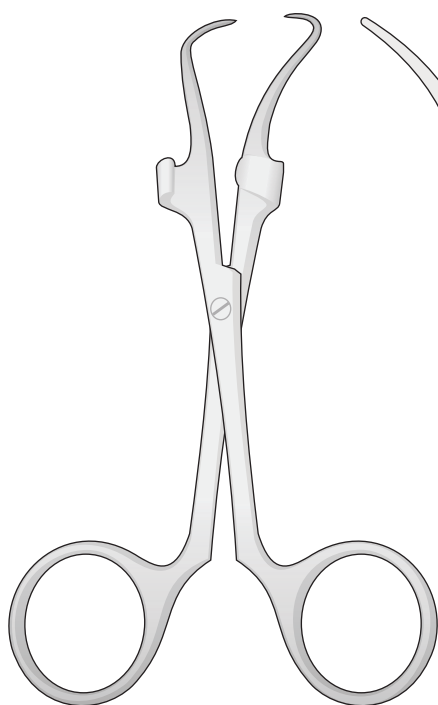

ROBIN
BF-72
140 mm

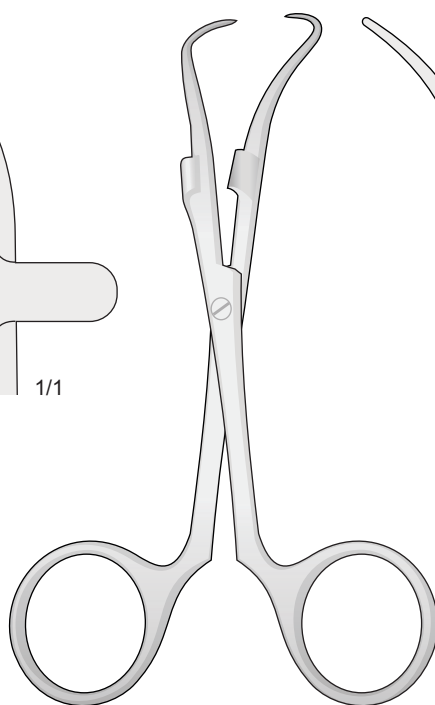

ROBIN
BF-73
140 mm

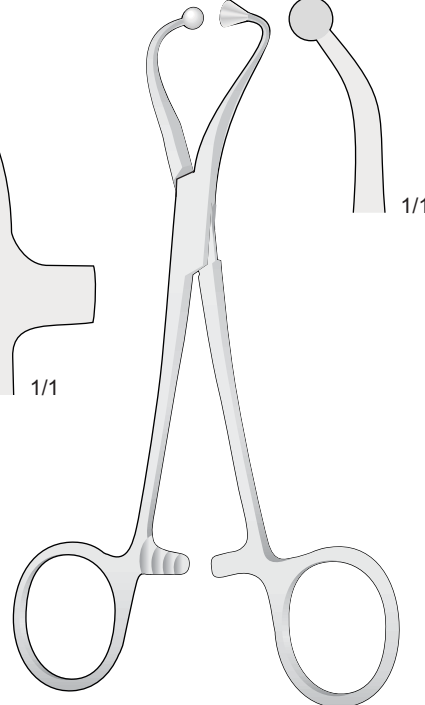

BF-75
140 mm

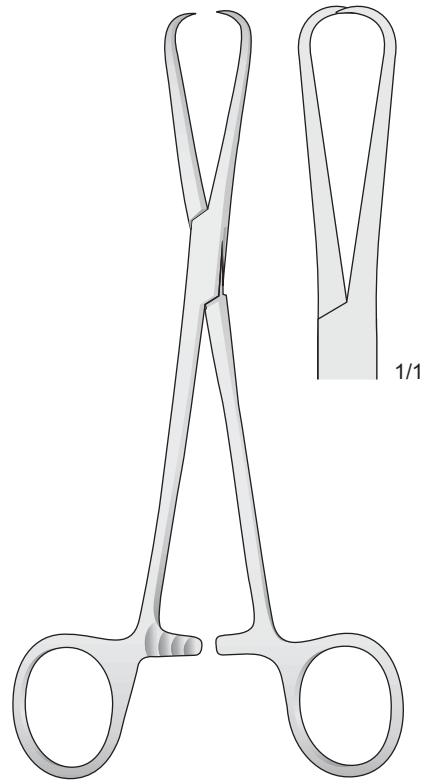

BERNHARD
BF-82
165 mm

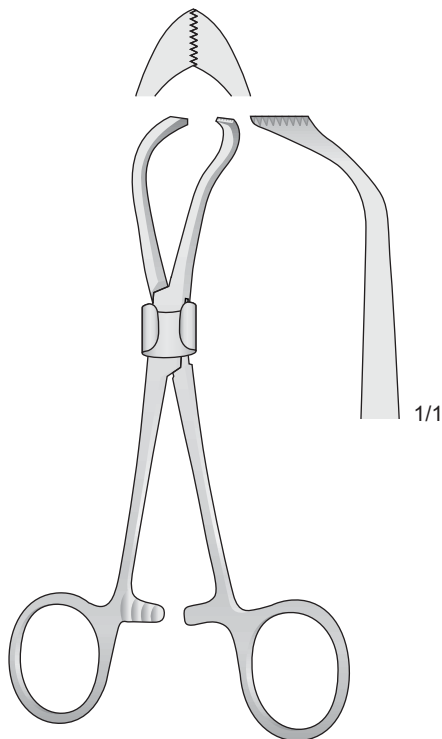

BF-85 Ø 9 mm **BF-86** Ø 12 mm
BF-87 Ø 14 mm **BF-88** Ø 17 mm
100 mm

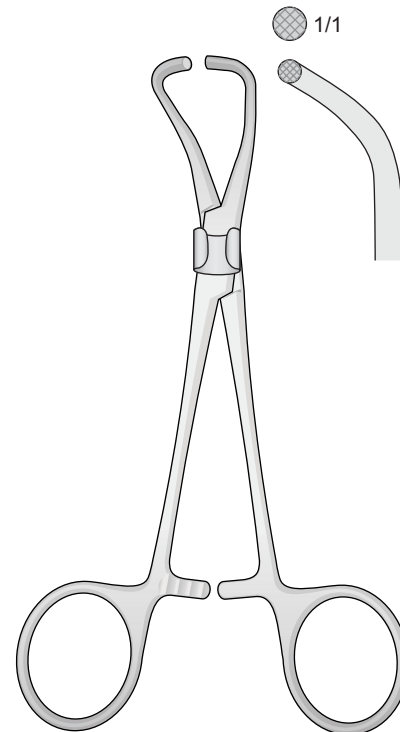

BF-90 Ø 9 mm **BF-91** Ø 12 mm
BF-92 Ø 14 mm **BF-93** Ø 17 mm
130 mm

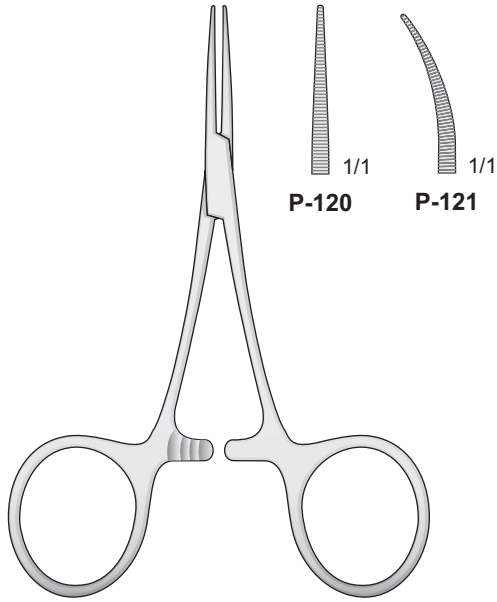

HARTMANN-BABY-MOSQUITO
P-120/P-121
95 mm

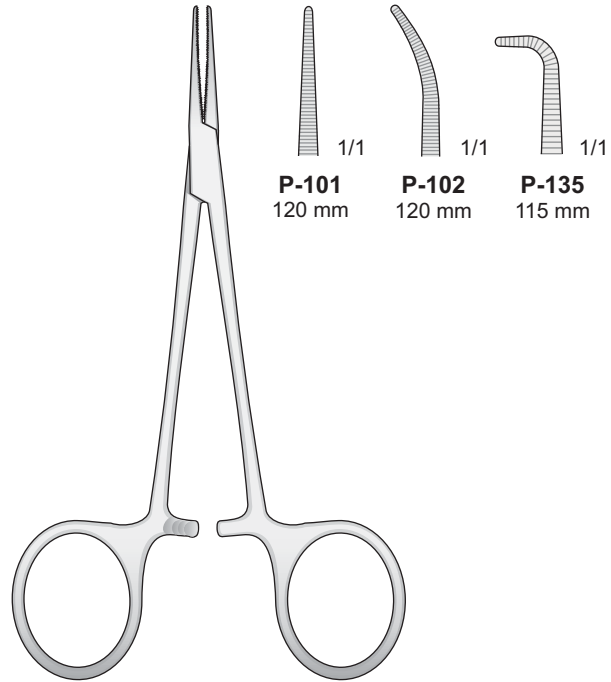

MICRO-HALSTED
P-101/P-135

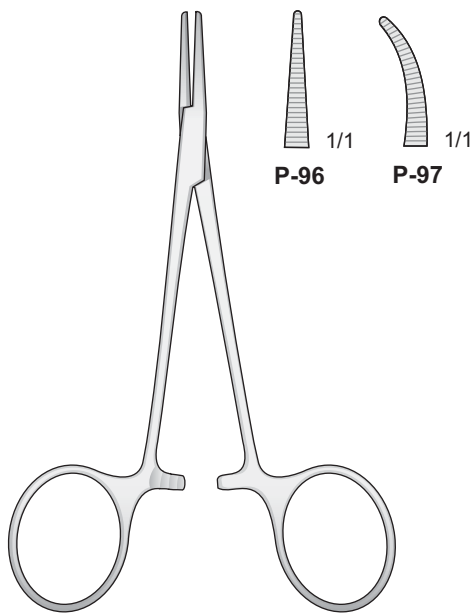

HALSTED-MOSQUITO
P-96/P-97
120 mm

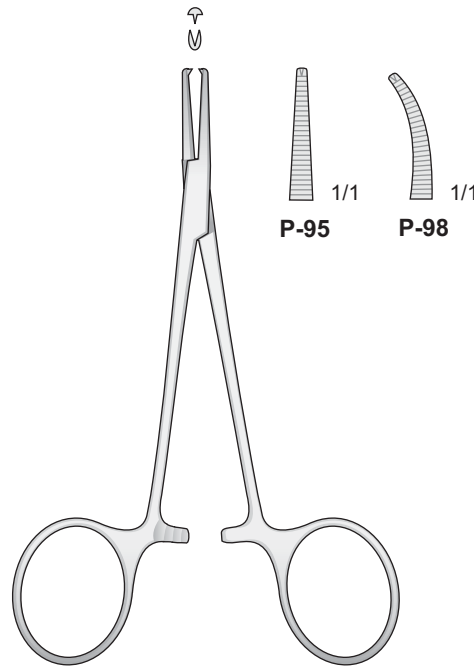

HALSTED-MOSQUITO
P-95/P-98
120 mm

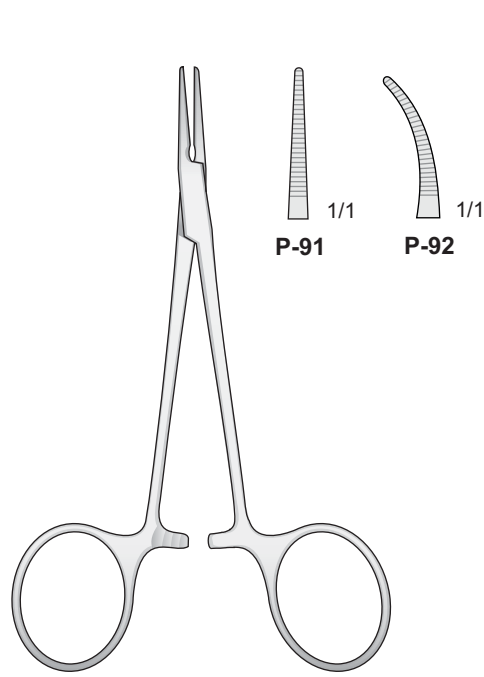

HALSTED
P-91/P-92
125 mm

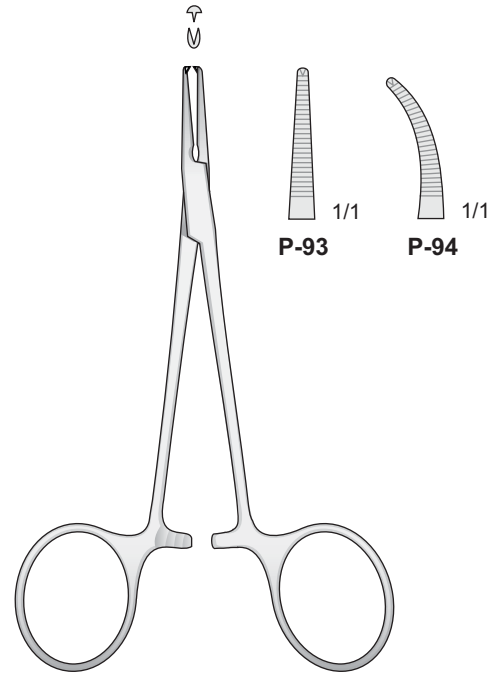

HALSTED
P-93/P-94
125 mm

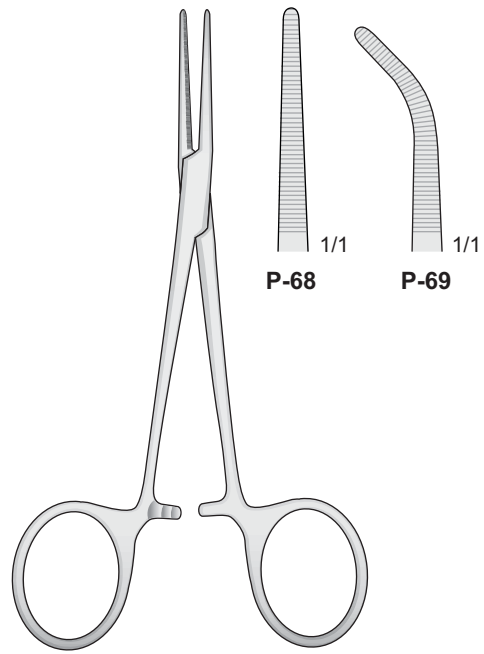

GIDEF
P-68/P-69
140 mm

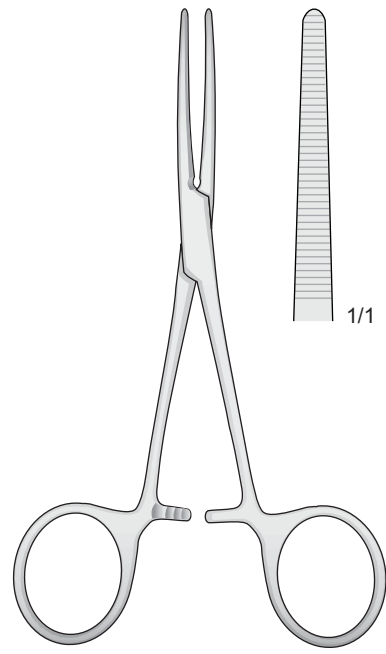

PEAN
P-17
140 mm

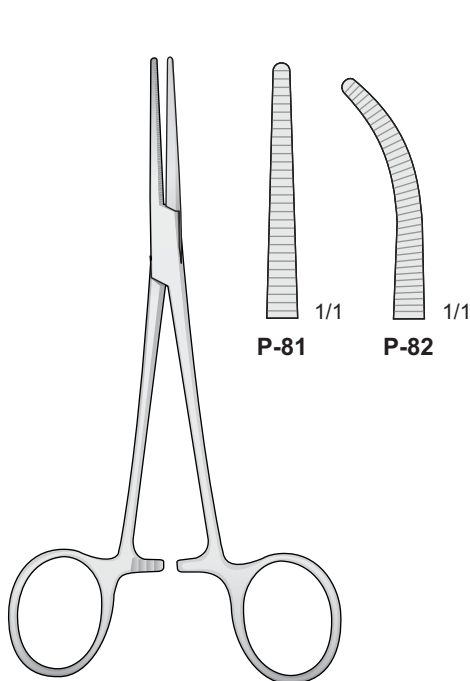

CRILE
P-81/P-82
140 mm

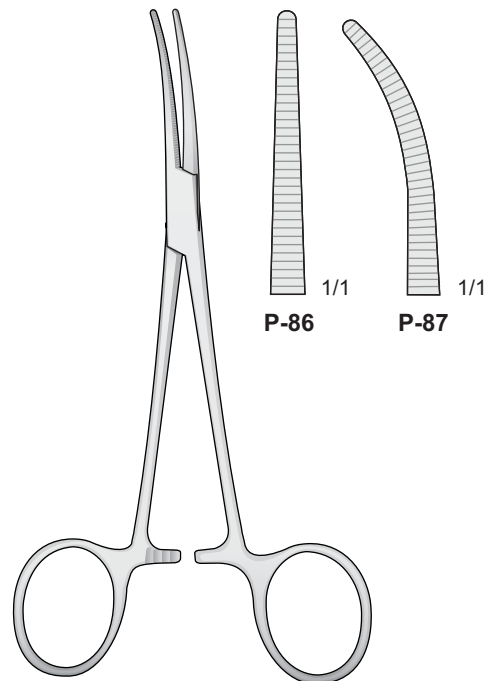

CRILE
P-86/P-87
160 mm

Curve sul lato
Curved to side
Seitwärts gebogen
Courbes latérales
Curvas laterales

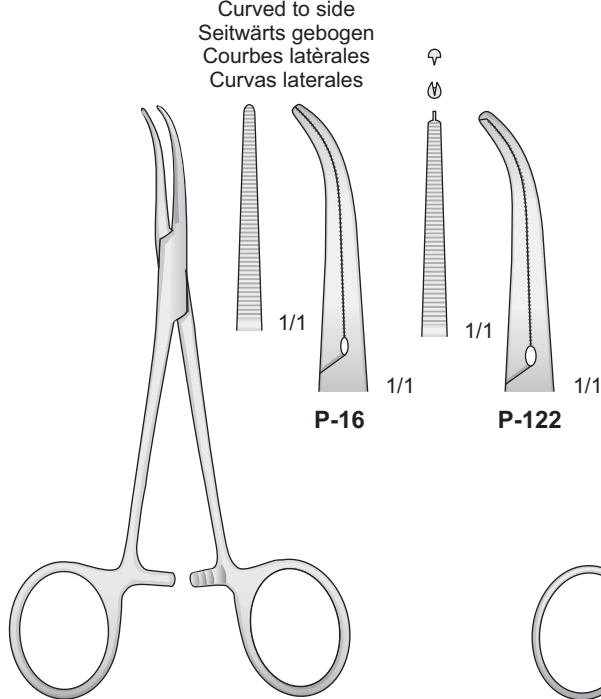

DANDY
P-16/P-122
140 mm

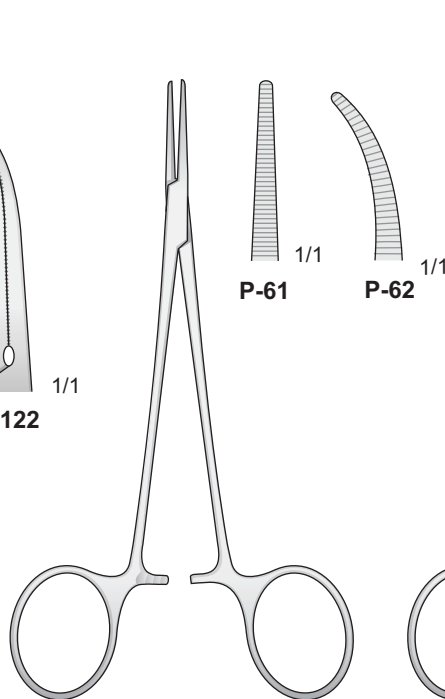

LERICHE
P-61/P-62
150 mm

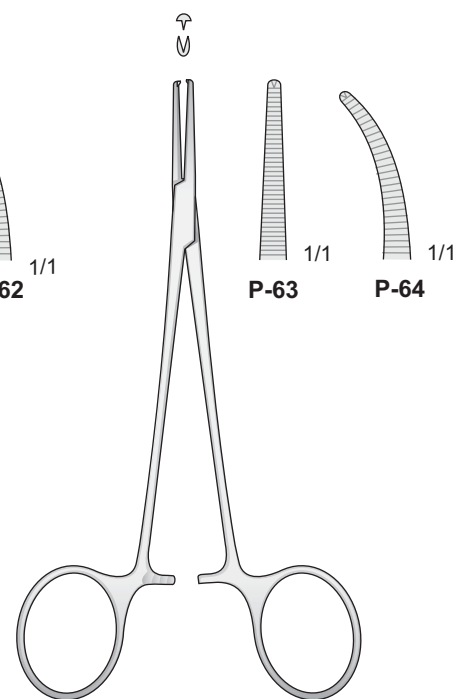

LERICHE
P-63/P-64
150 mm

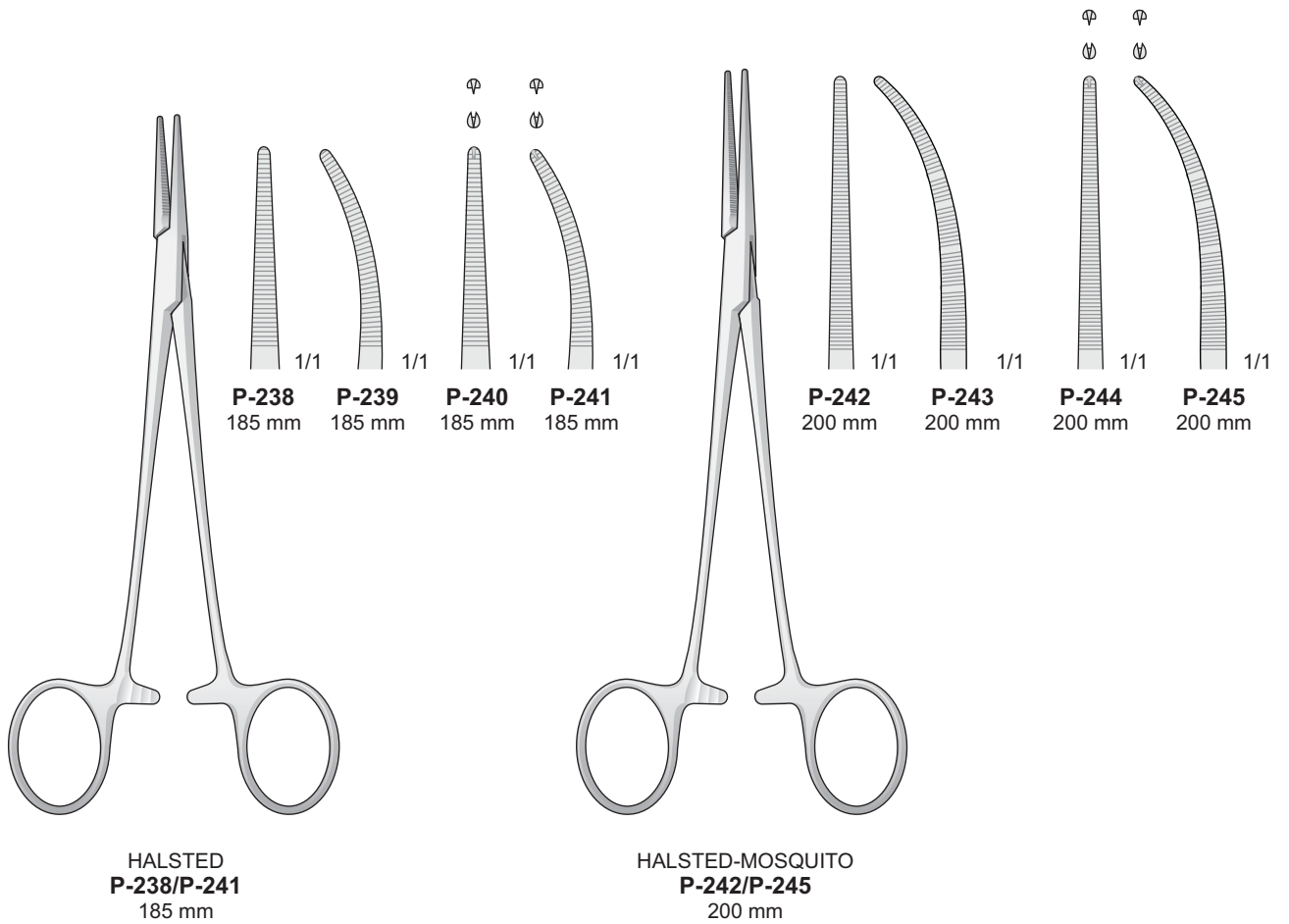
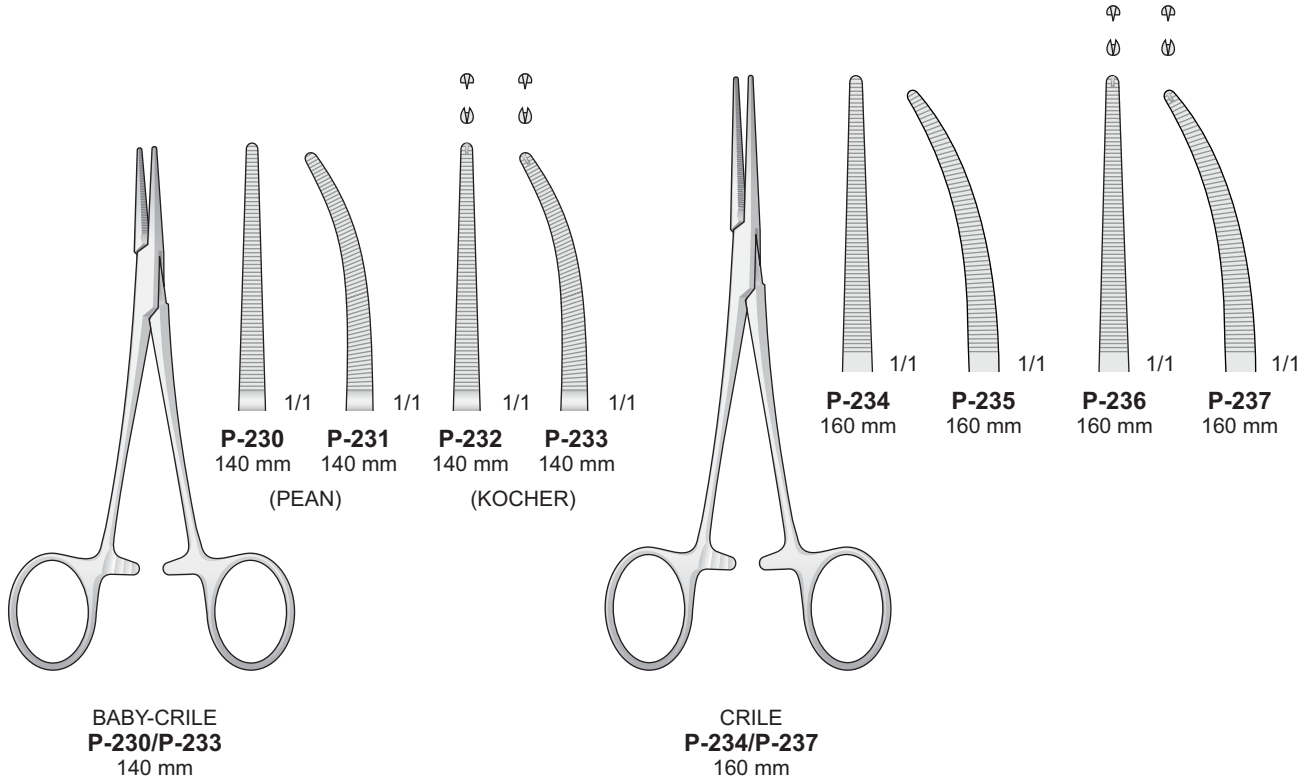

05

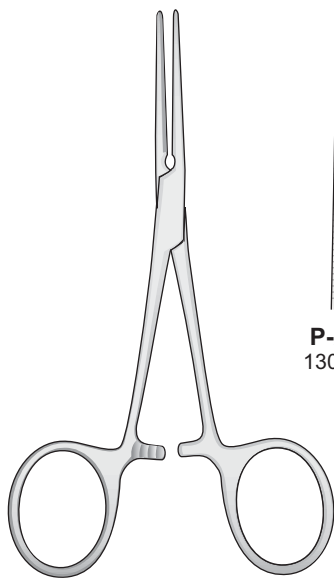

PEAN
P-250/P-255

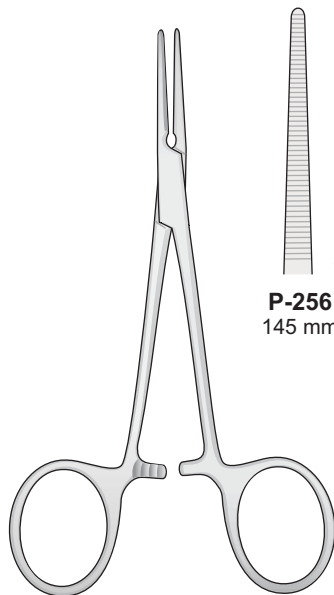
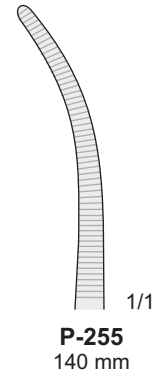
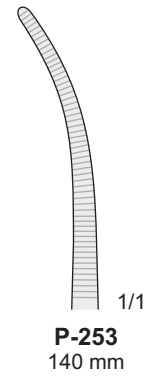
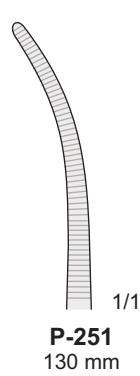
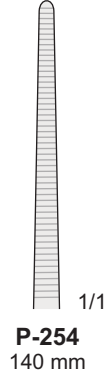
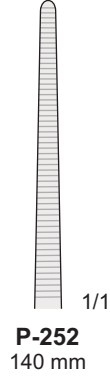
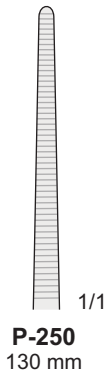

PEAN
P-256/P-259

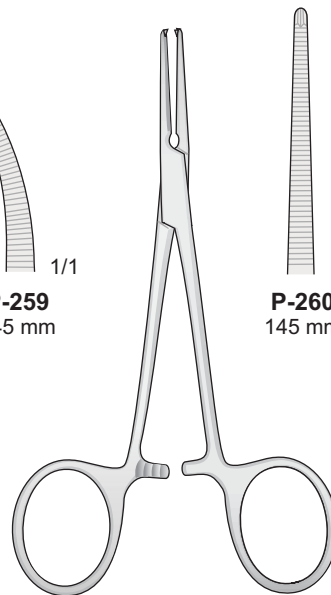
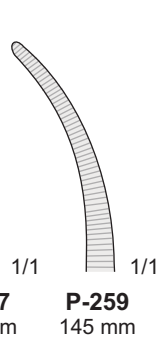
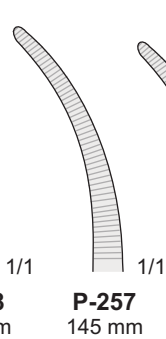
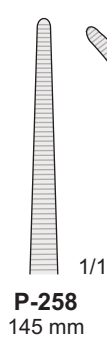
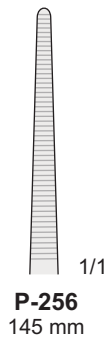

KOCHER
P-260/P-263

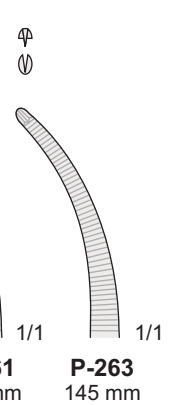
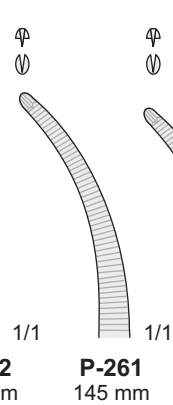
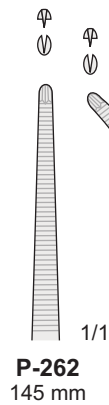
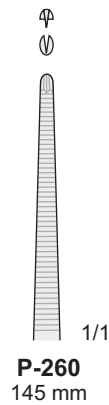

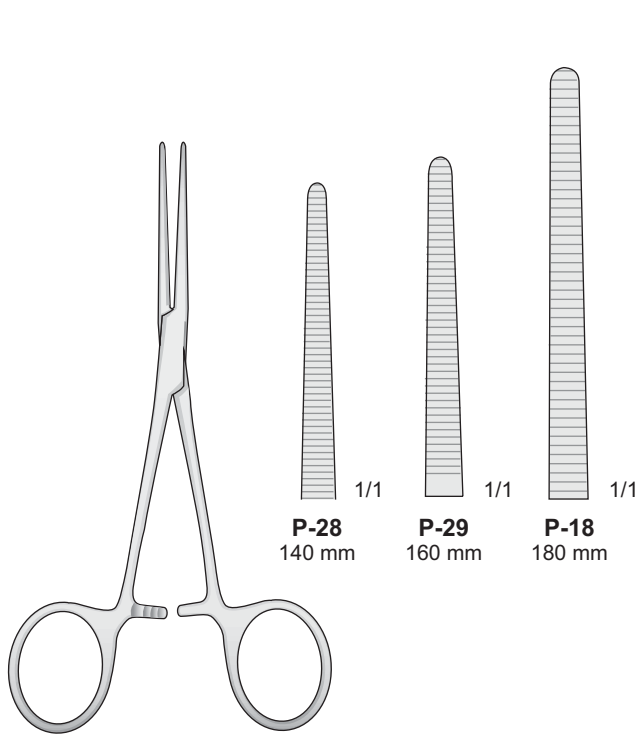

P-28
140 mm

P-29
160 mm

P-18
180 mm

ROCHESTER-PEAN
P-28/P-18

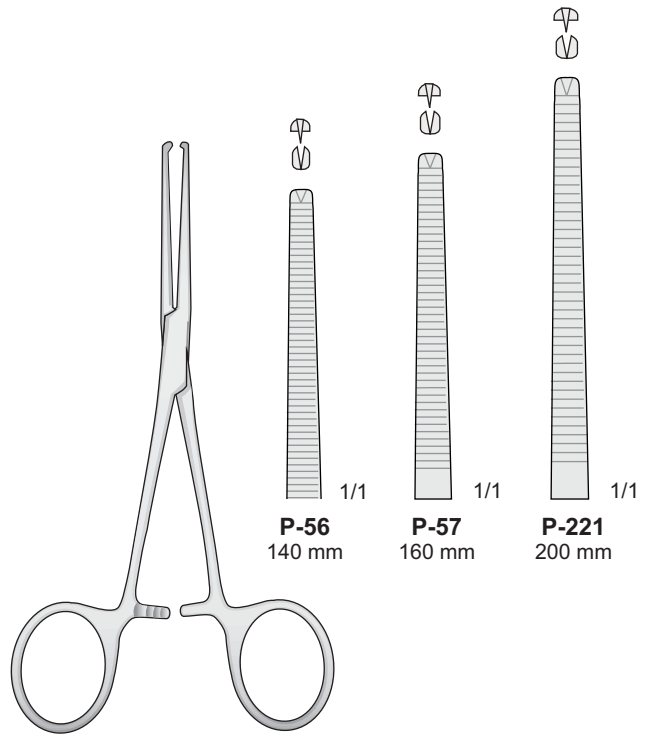

P-56
140 mm

P-57
160 mm

P-221
200 mm

KOCHER-OCHSNER
P-56/P-221

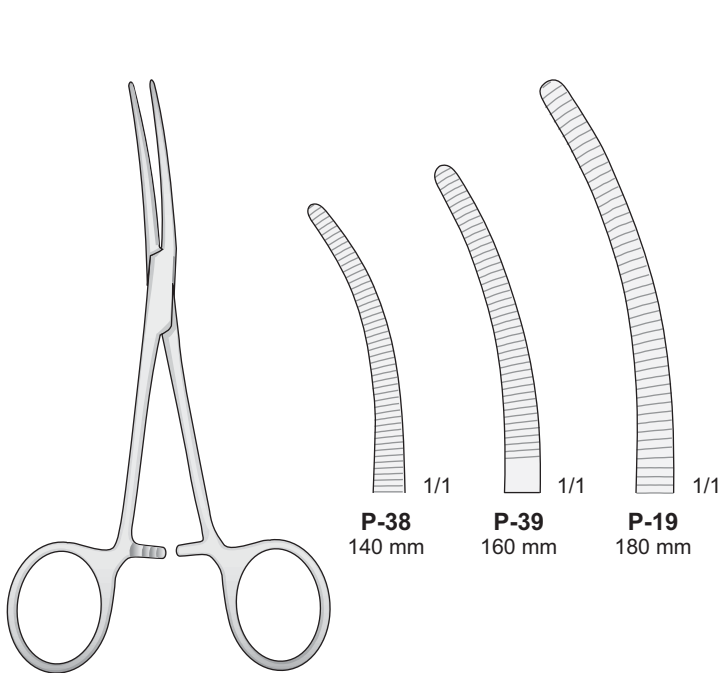

P-38
140 mm

P-39
160 mm

P-19
180 mm

ROCHESTER-PEAN
P-38/P-19

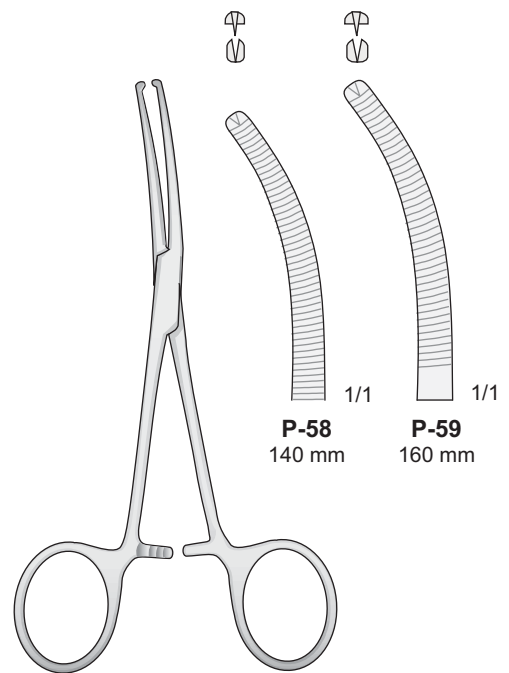

P-58
140 mm

P-59
160 mm

KOCHER-OCHSNER
P-58/P-59

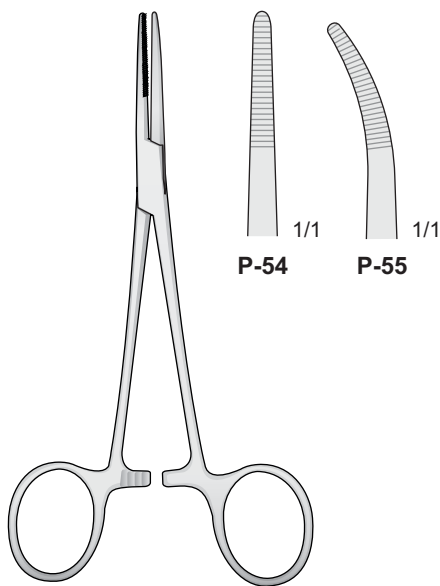

KELLY
P-54/P-55
140 mm

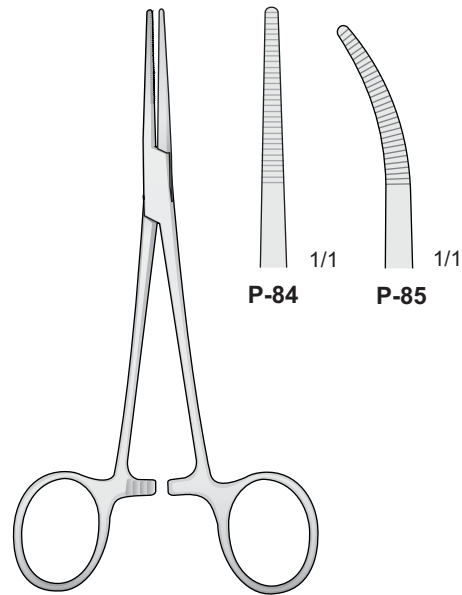

KELLY
P-84/P-85
140 mm

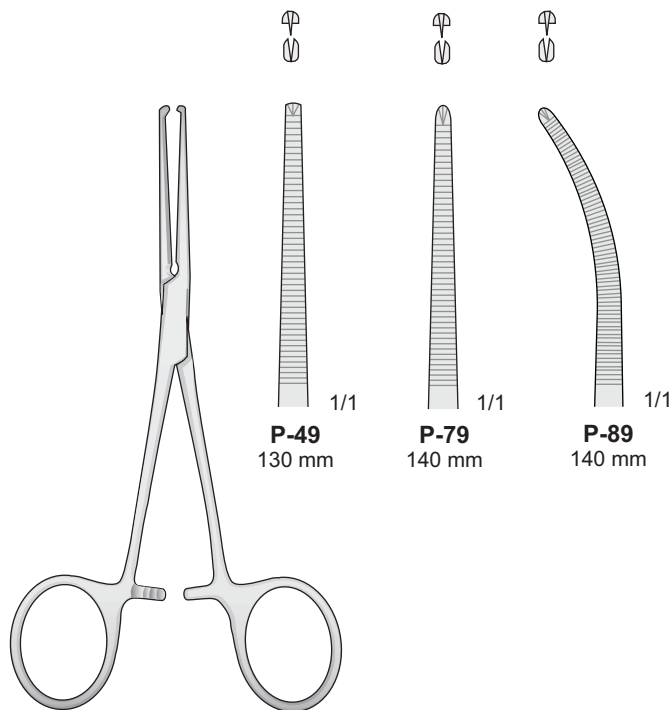

KOCHER
P-49/P-89

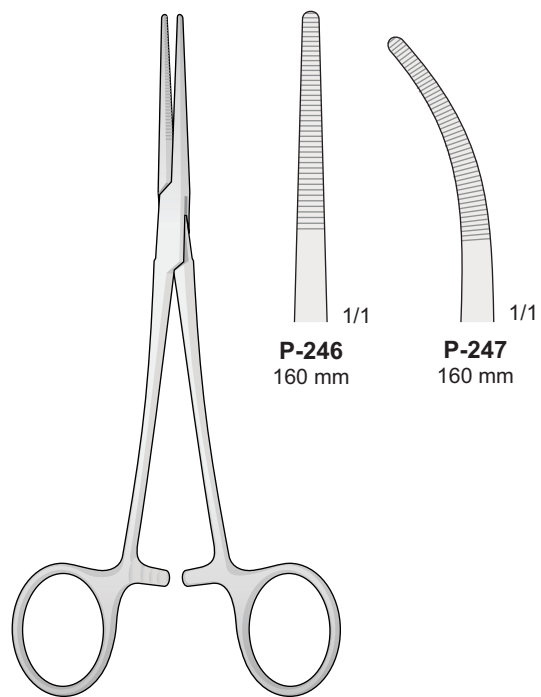

RANKIN
P-246/P-247

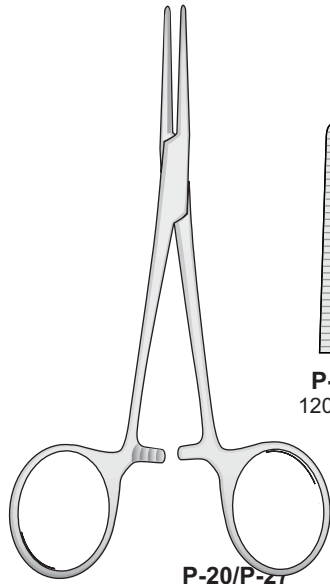

P-20/P-27

PEAN

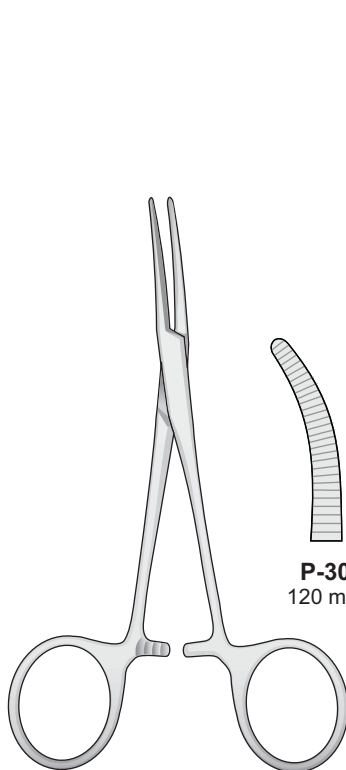
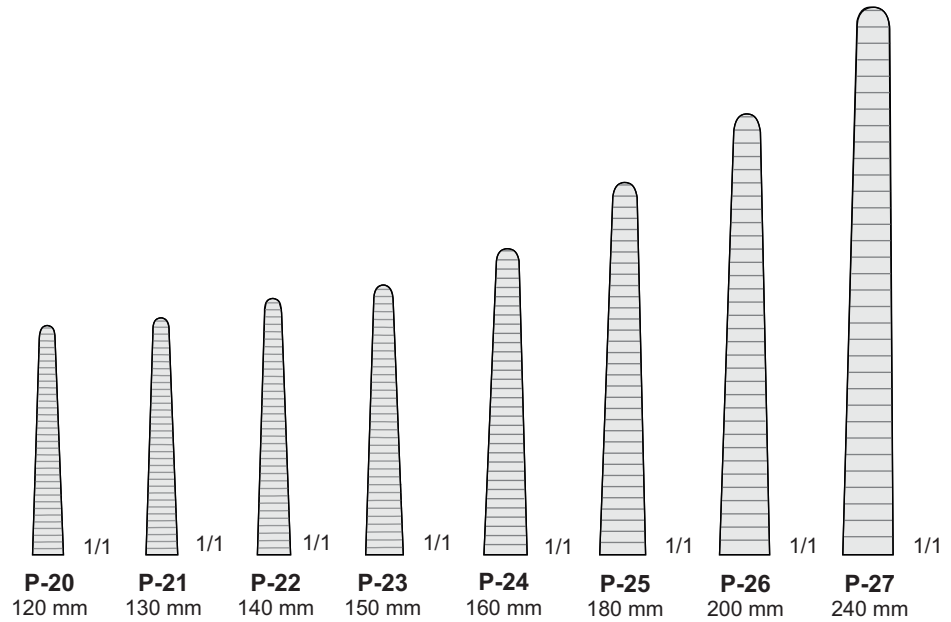

PEAN
P-30/P-37

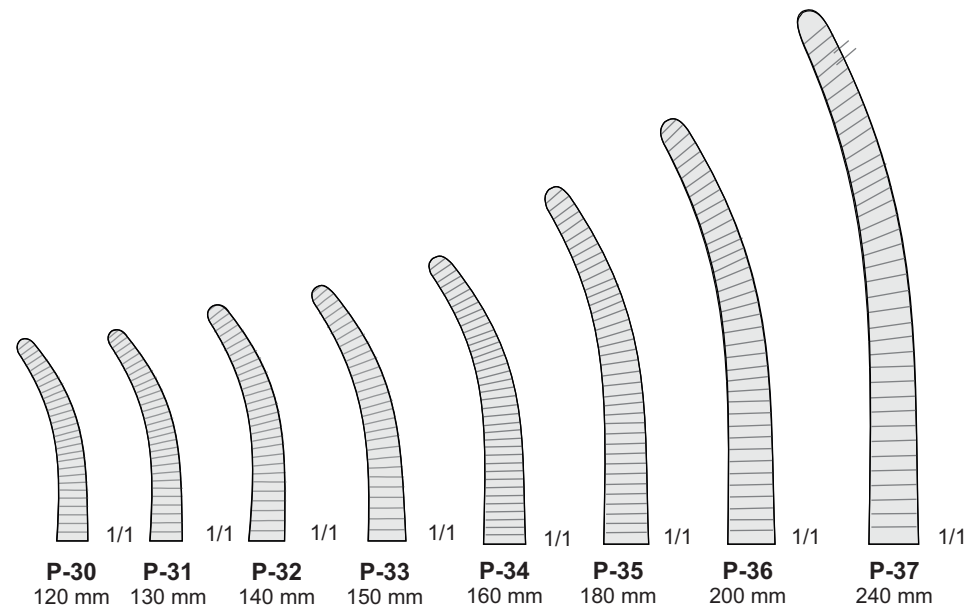

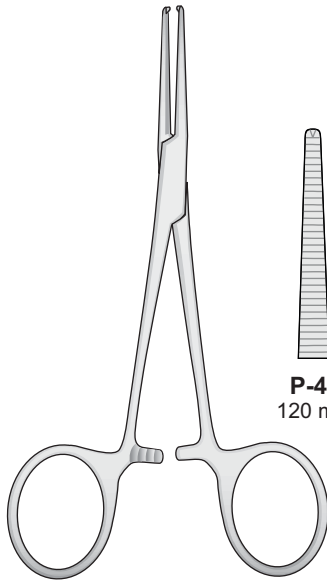

KOCHER
P-40/P-47

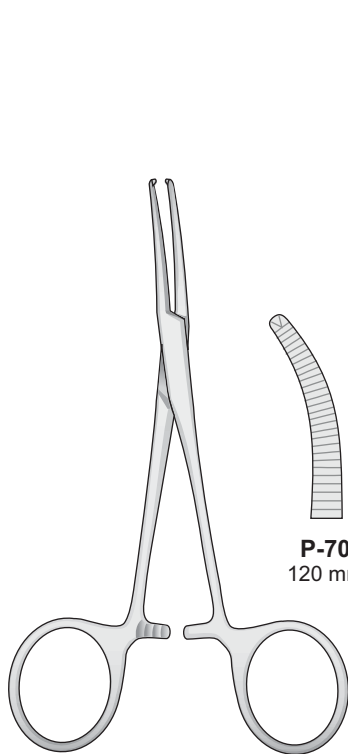
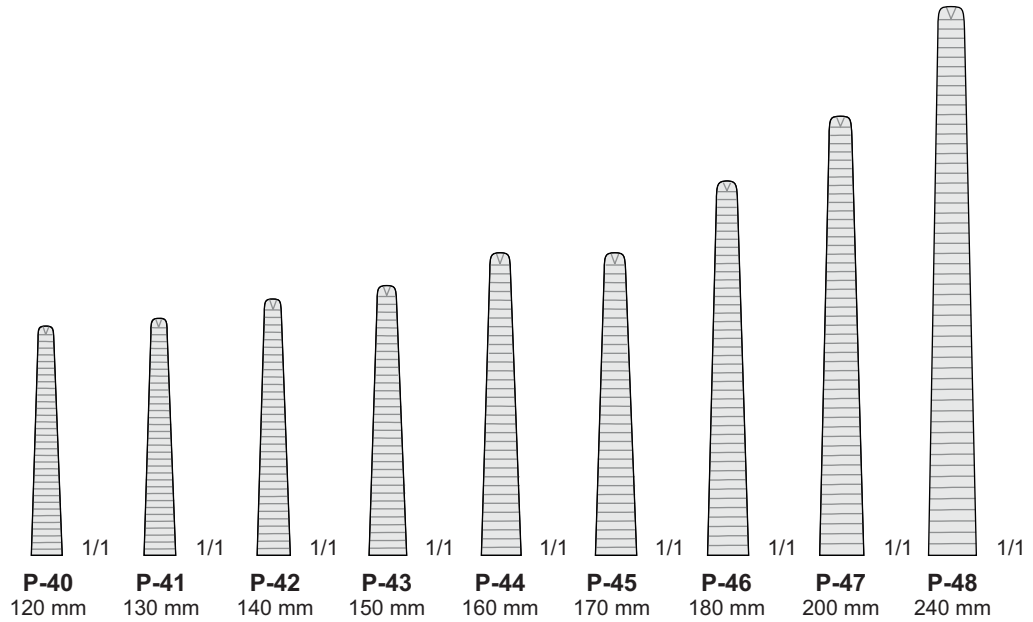

KOCHER
P-70/P-77

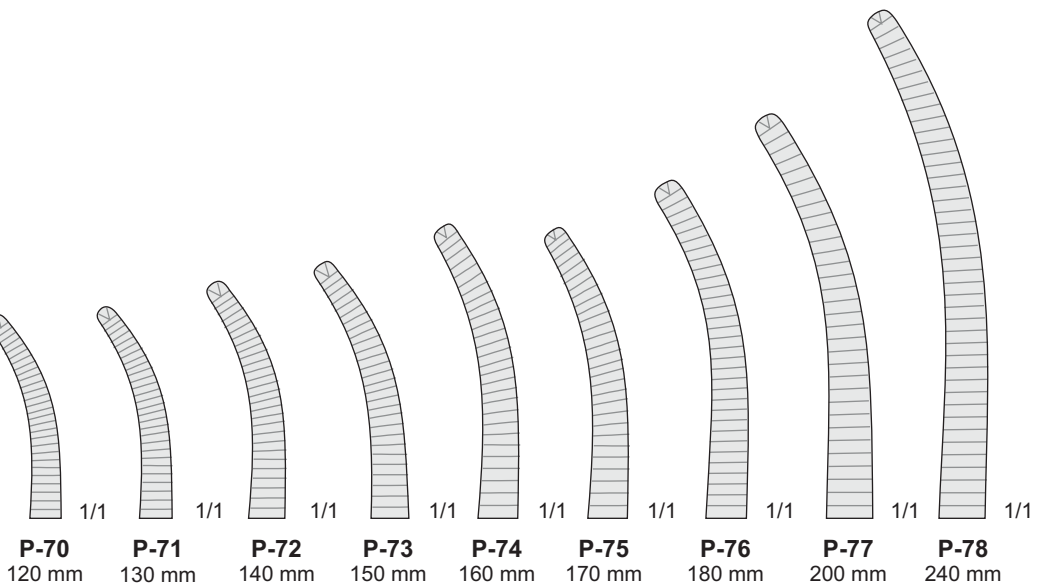

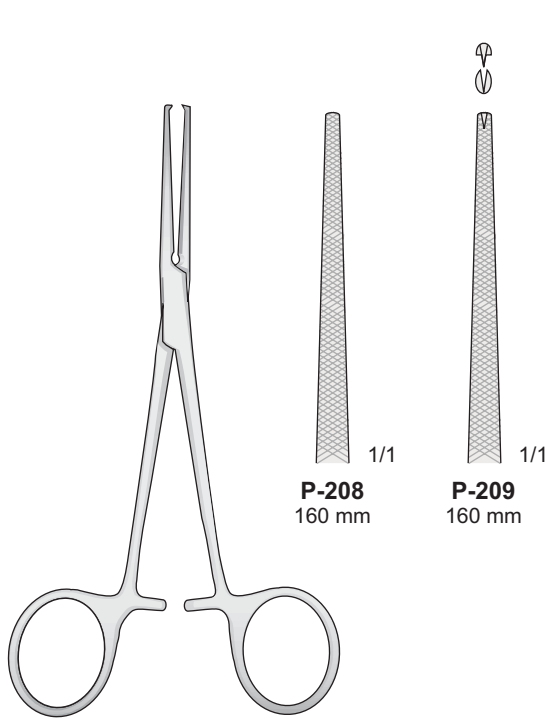

DIXON-LOVELACE
P-208/P-209

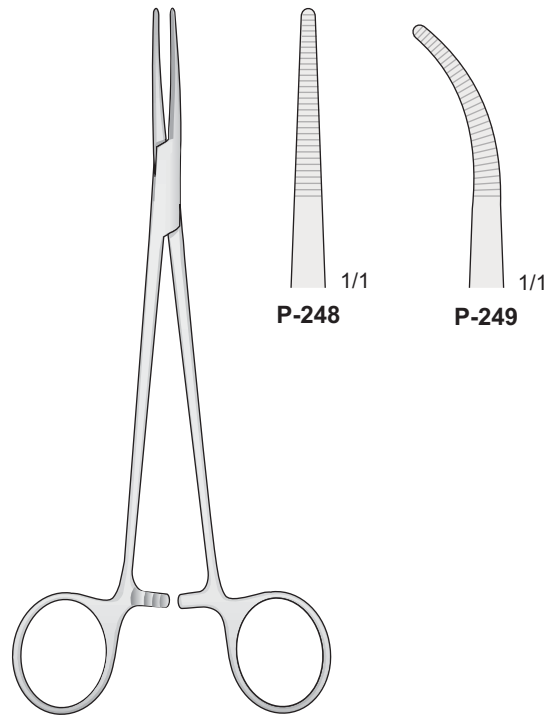

BIRKETT
P-248/P-249
180 mm

Pinza per peritoneo - Peritoneal clamps forceps
Pritoneum klemmen - Pincen-camps pour les péritoine
Pinzas-clamps para peritoneo

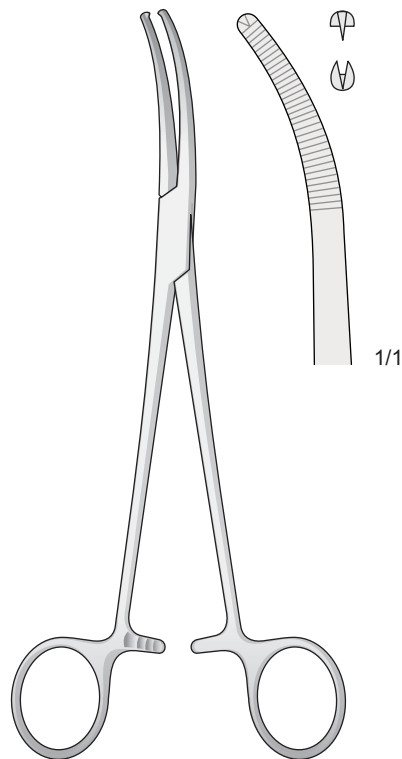

MIKULICZ
P-104
190 mm

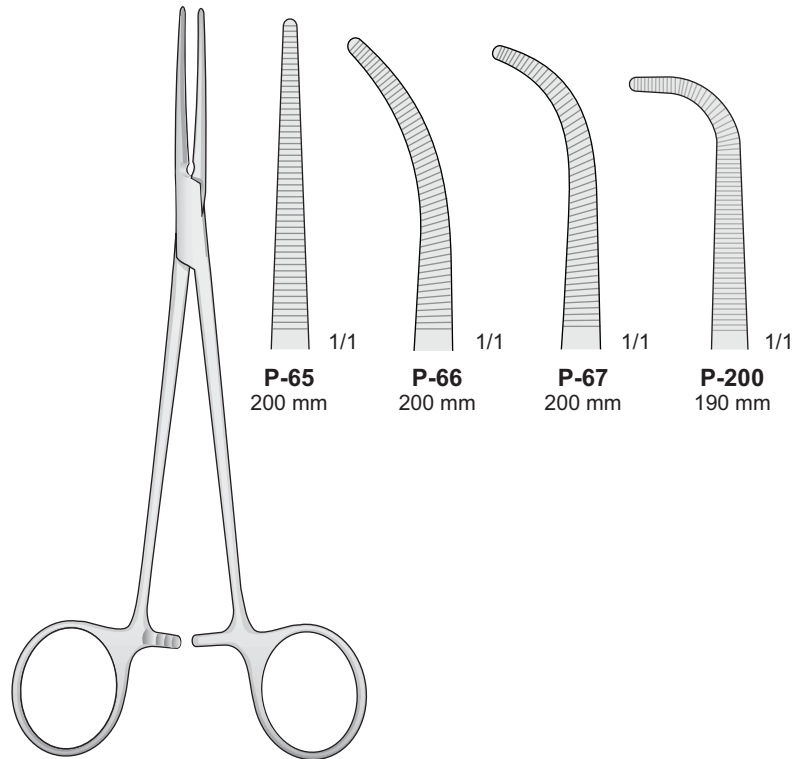

HEISS
P-65/P-200

05

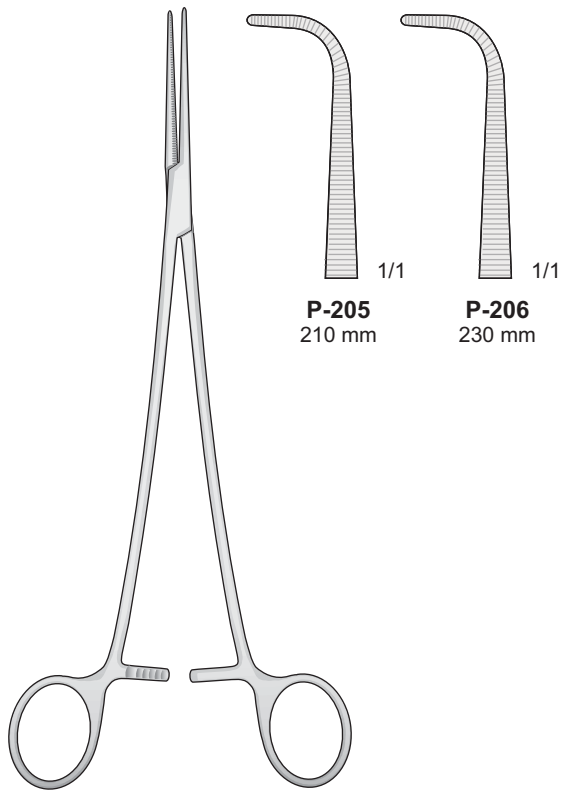

BENGOLEA
P-205/P-206

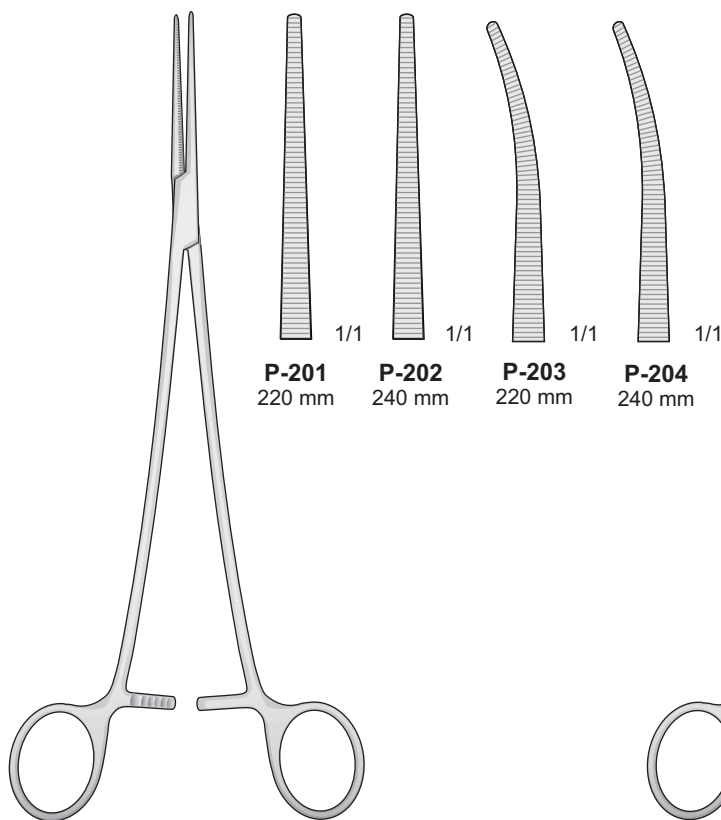

BENGOLEA
P-201/P-204

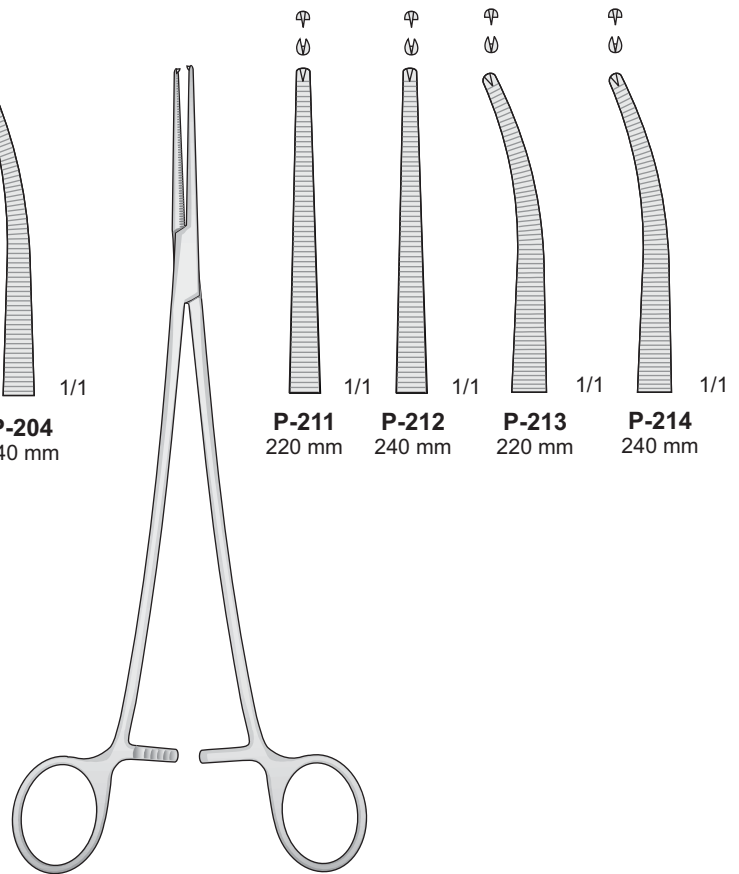

BENGOLEA
P-211/P-214

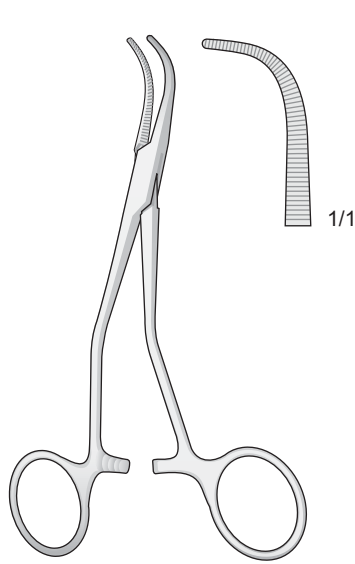

P-15
130 mm

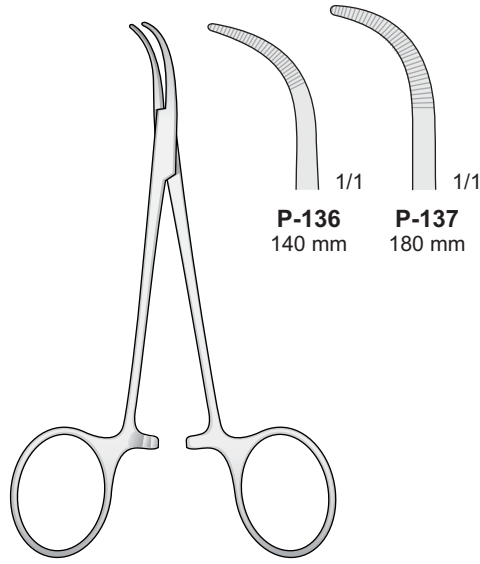

BABY-MIXTER
P-136/P-137

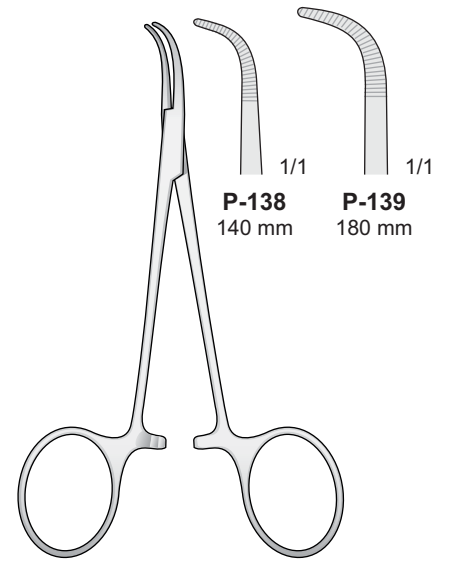

BABY-ADSON
P-138/P-139

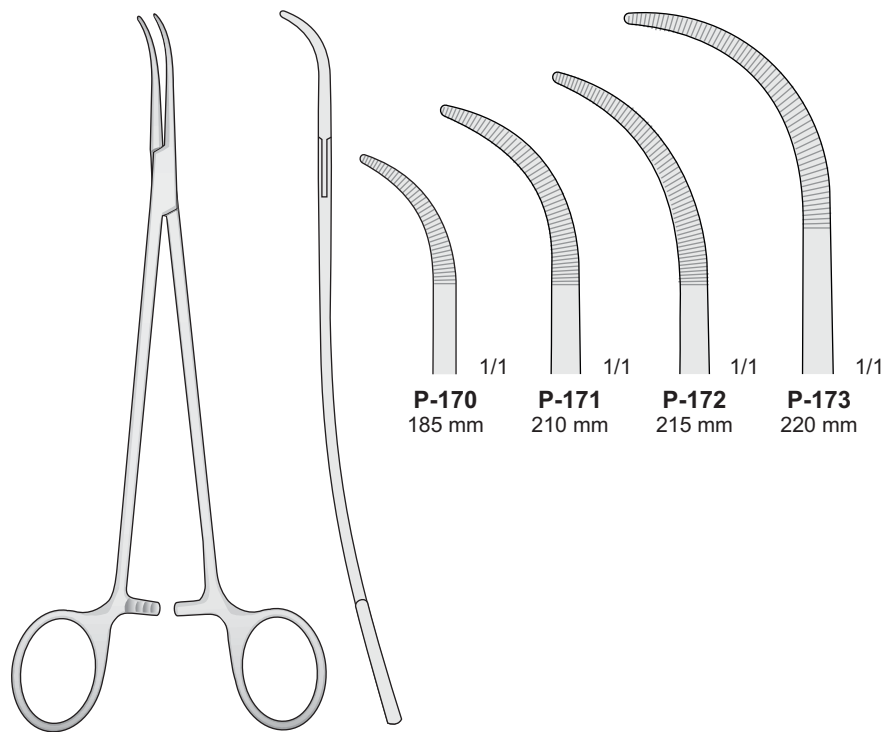

P-170/P-172

Passafilii

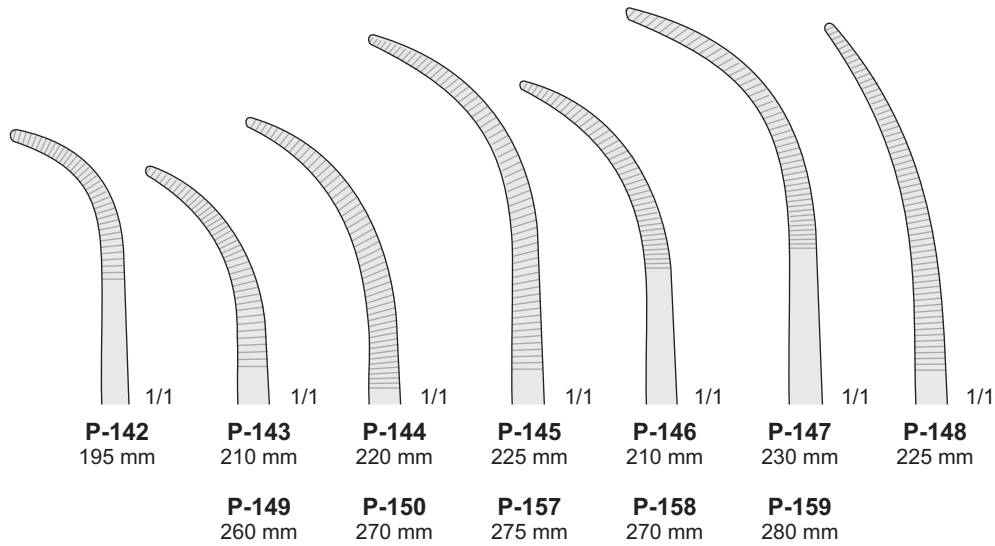
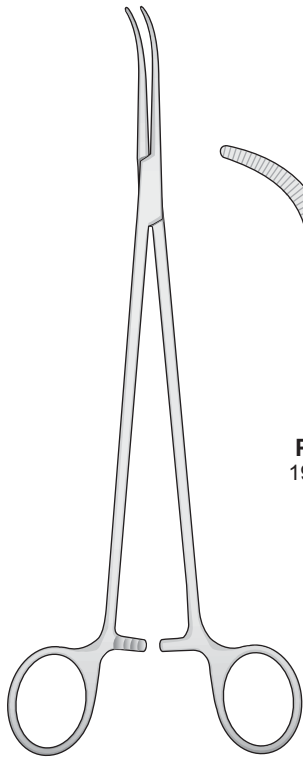

OVERHOLT-GEISSENDORFER
P-142/P-159

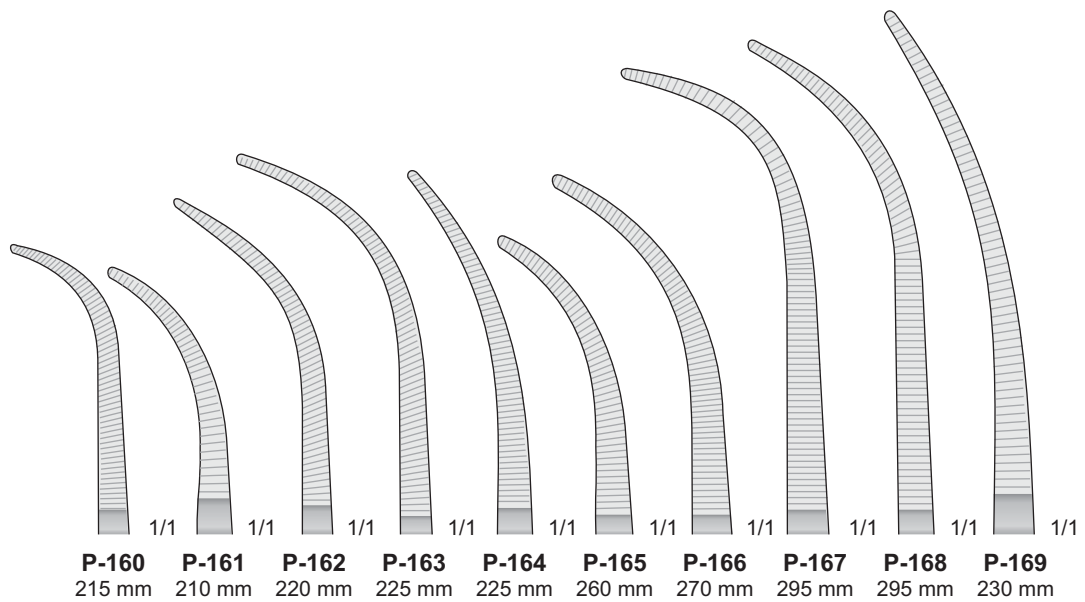
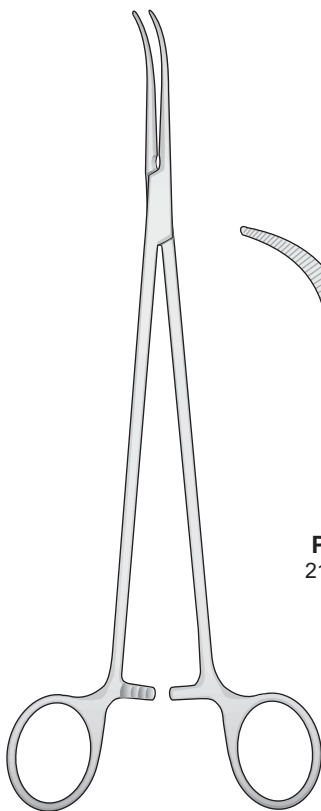

OVERHOLT
P-160/P-169

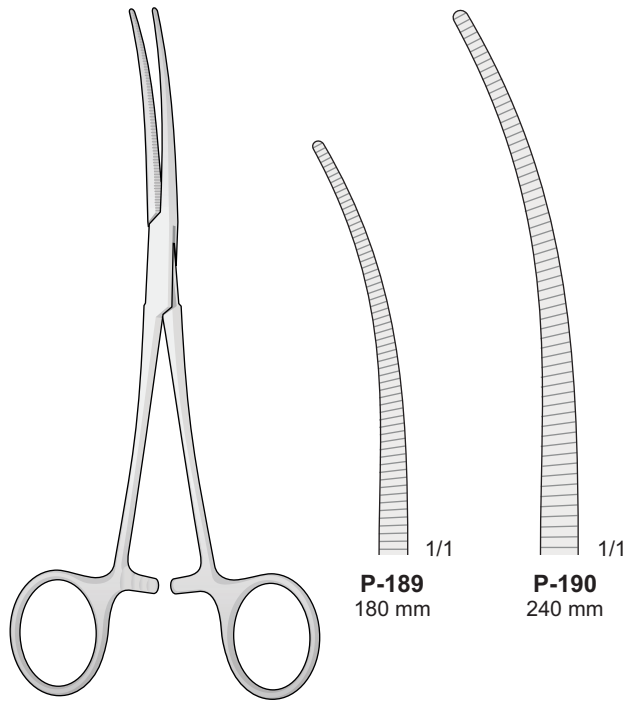

CRAFOORD
P-189/P-190

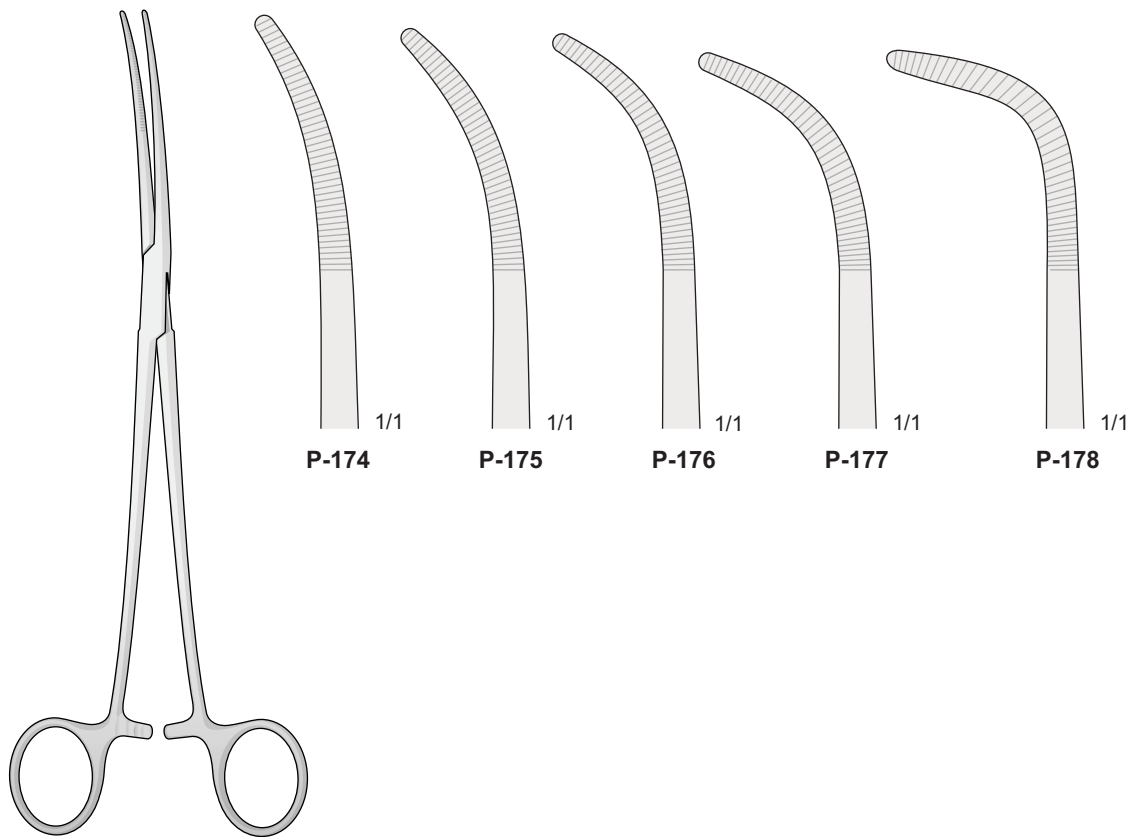

RUMEL
P-174/P-178
240 mm

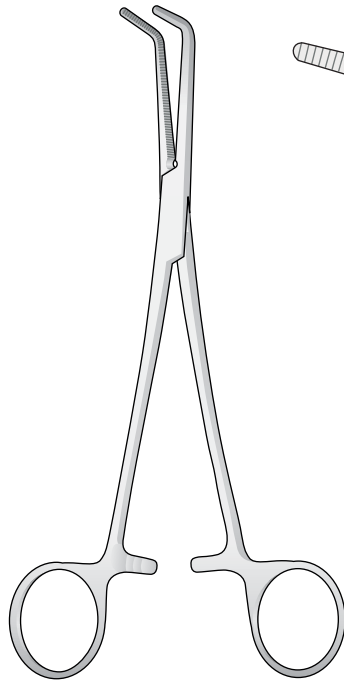

MIXTER
P-123/P-125

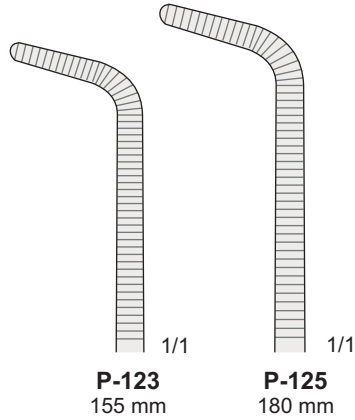

P-123
155 mm

P-125
180 mm

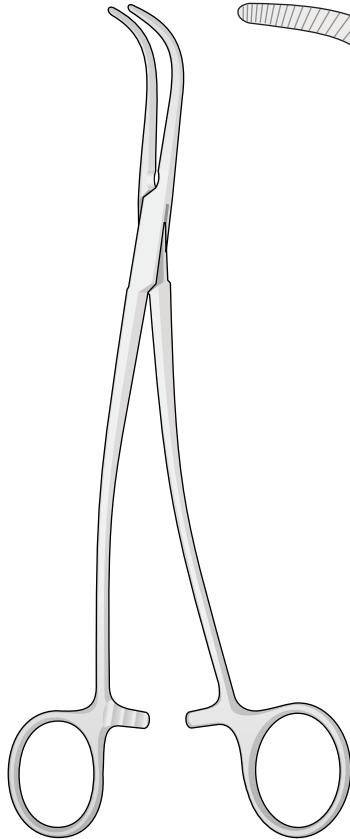

GRAY
P-179/P-180
220 mm

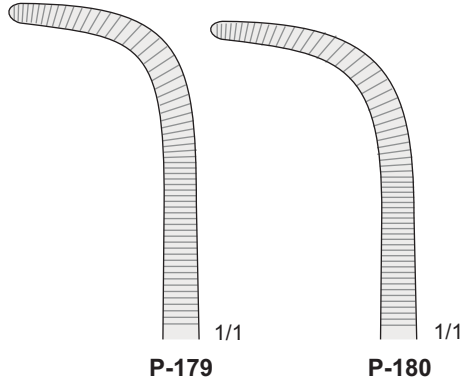

P-179

P-180

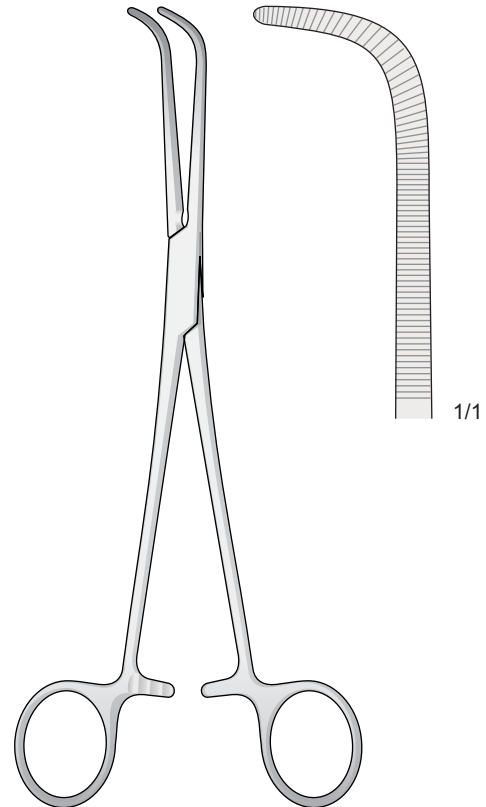

WIKSTROEM
P-181
205 mm

Pinze per tonsille
Tonsil forceps
Tonsillenklemmen
Pinces pour amygdales
Pinzas para amigdalas

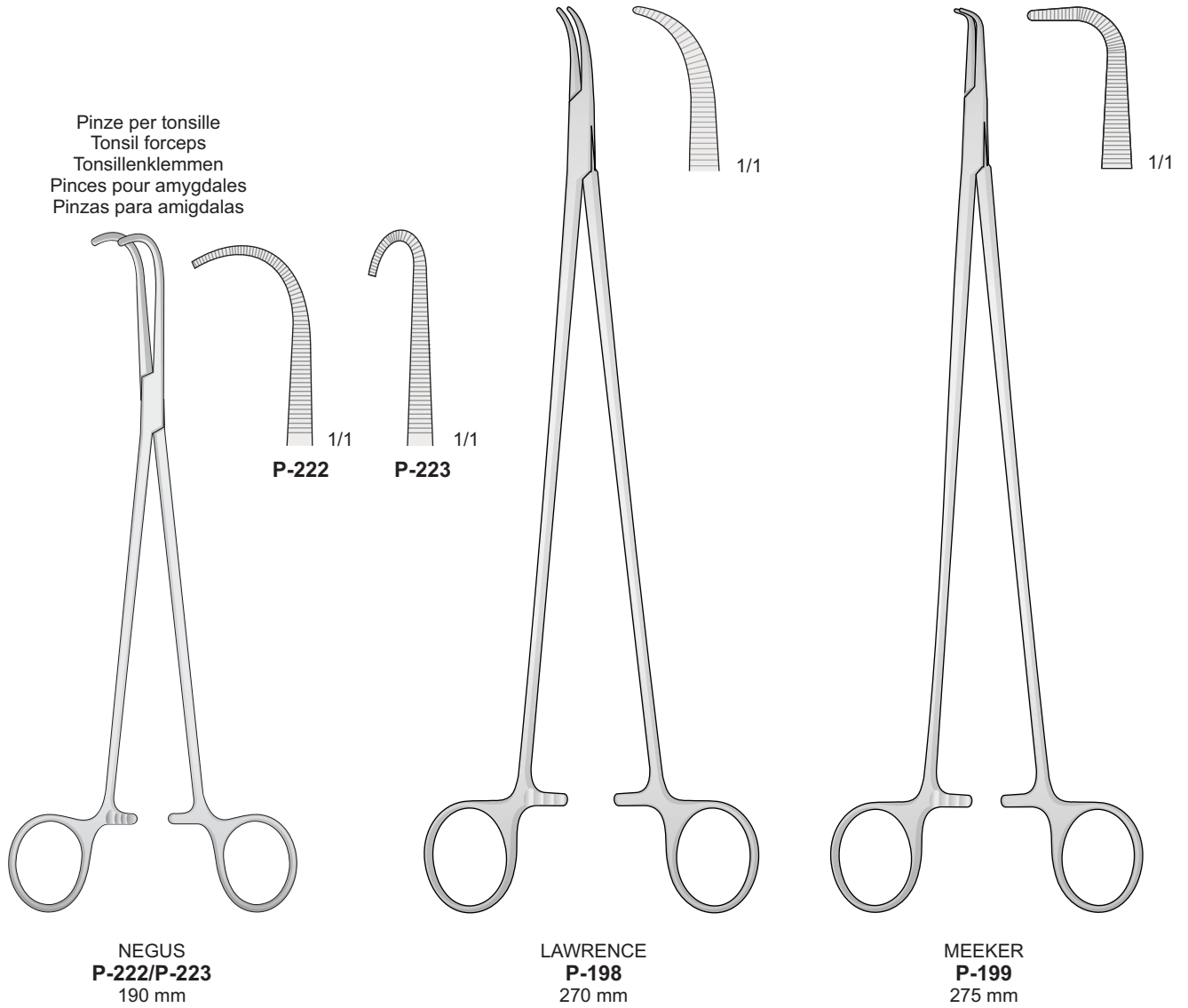

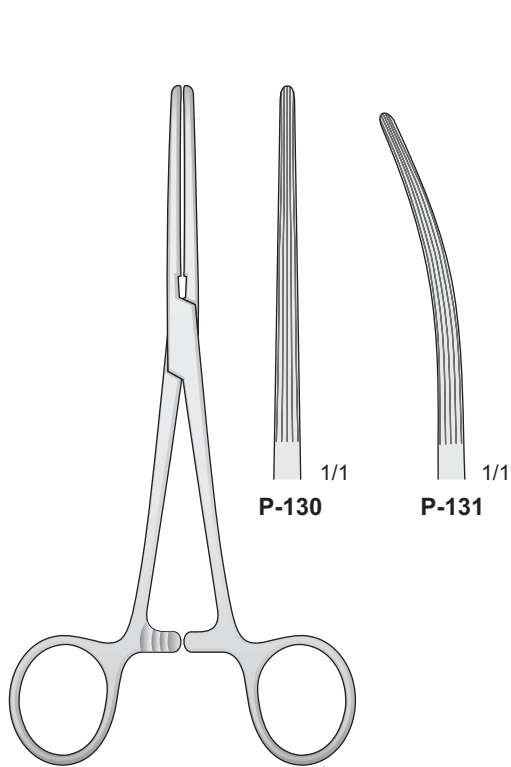

BAINBRIDGE
P-130/P-131
150 mm

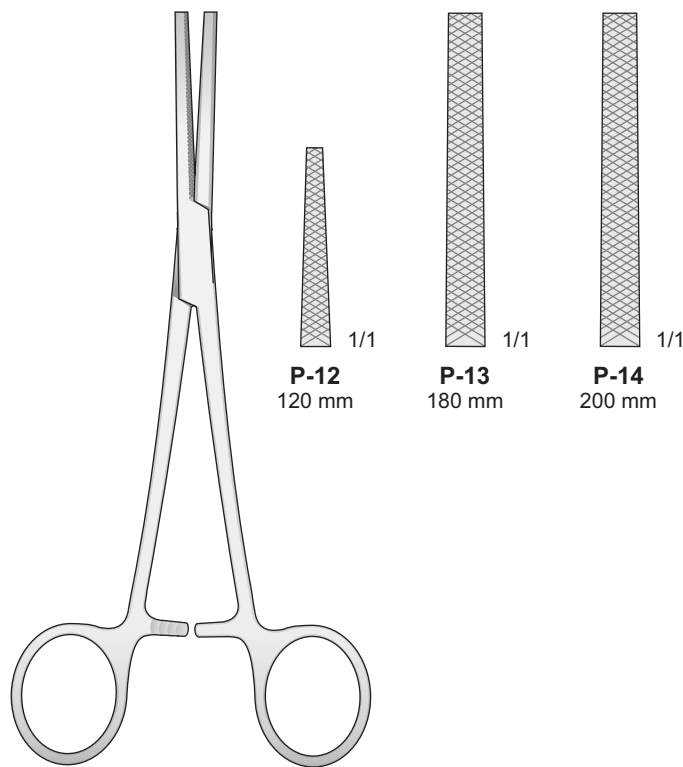

P-12/P-14

Angiotribe - Druckklemmen
Angiotribes - Pinzas-clamps para presión progresiva

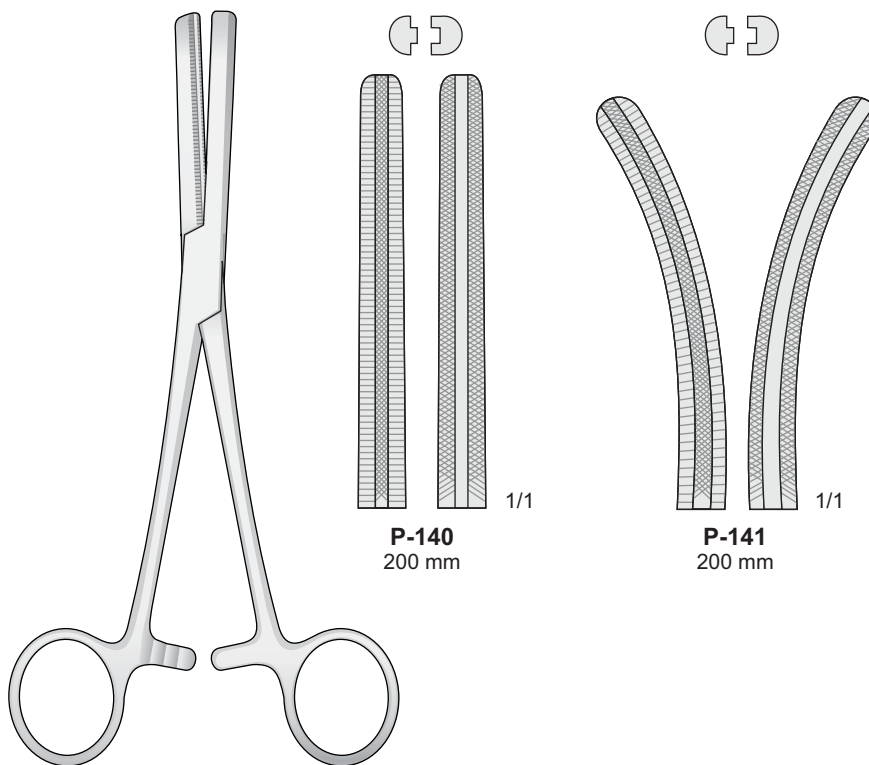

FERGUSON
P-140/P-141

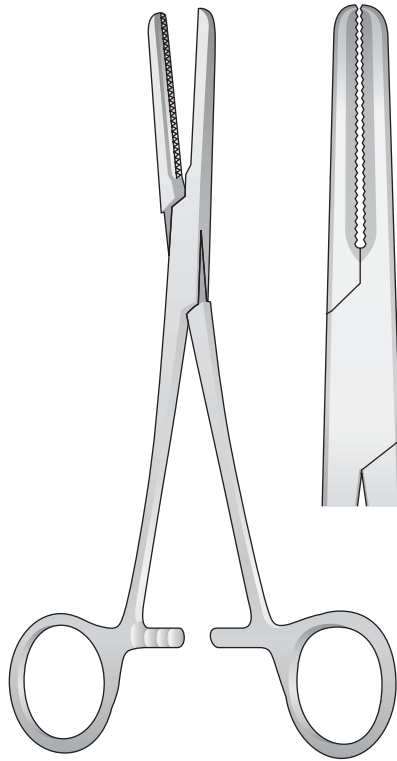

P-151/P-153

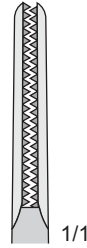

P-151
150 mm

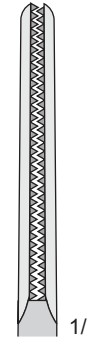

P-152
180 mm

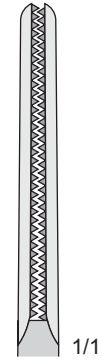

P-153
200 mm

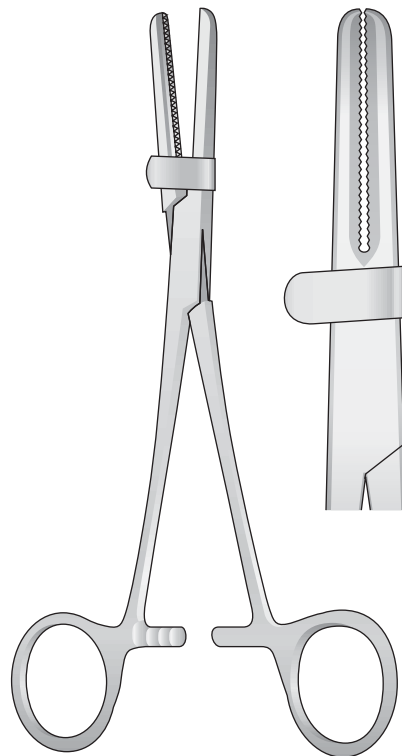

P-154/P-156

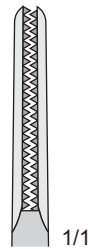

P-154
150 mm

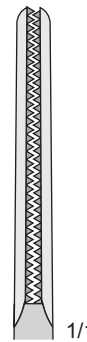

P-155
180 mm

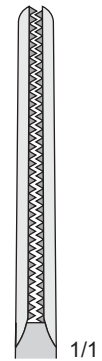

P-156
200 mm

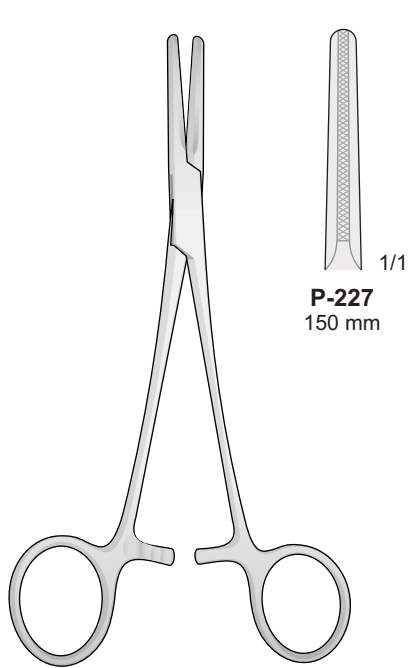

P-227
150 mm

P-228
180 mm

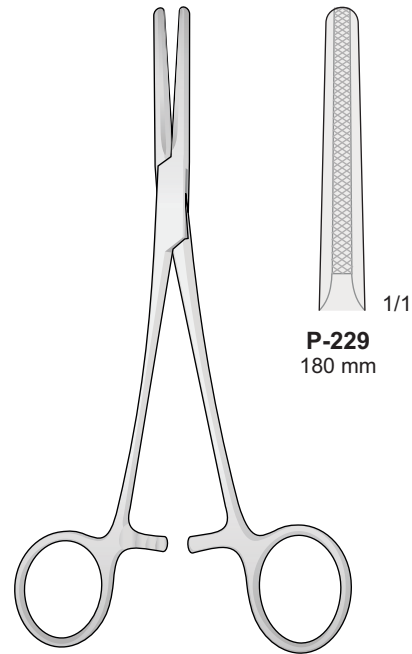

P-229
180 mm

P-227/P-228

P-229
180 mm

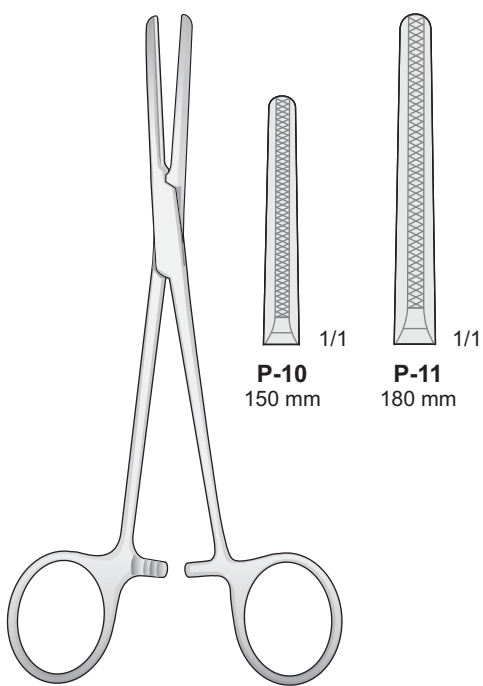

P-10
150 mm

P-11
180 mm

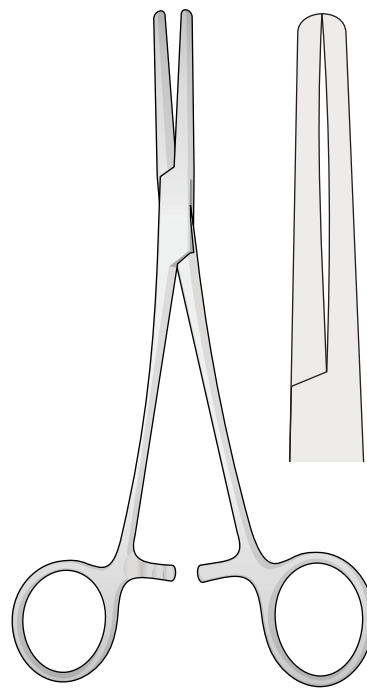

P-127
150 mm

P-128
180 mm

P-10/P-11

P-127/P-128

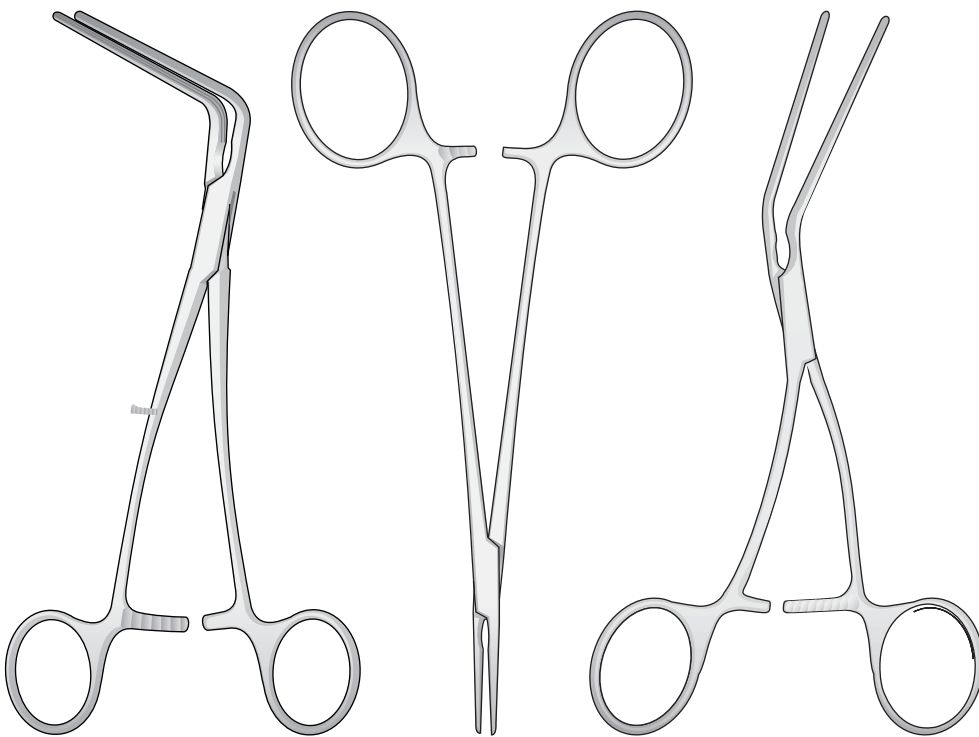

06 |

Atraumatic Vascular Clamps
Atraumatische Gefäßklemmen
Pinces vasculaires atraumatiques
Pinzas vasculares atraumáticas
Pinze vascolari atraumatiche

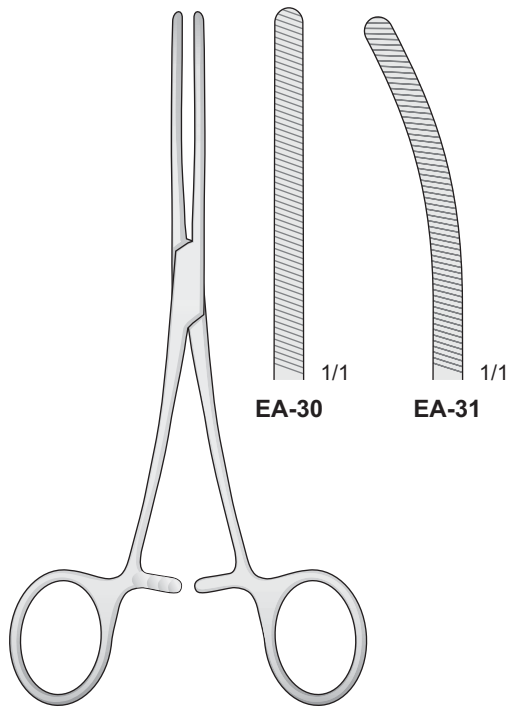

DOYEN
EA-30/EA-31
170 mm

Atraumatiche - Atraumatic
Atraumatische - Atraumatiques - Atraumáticas

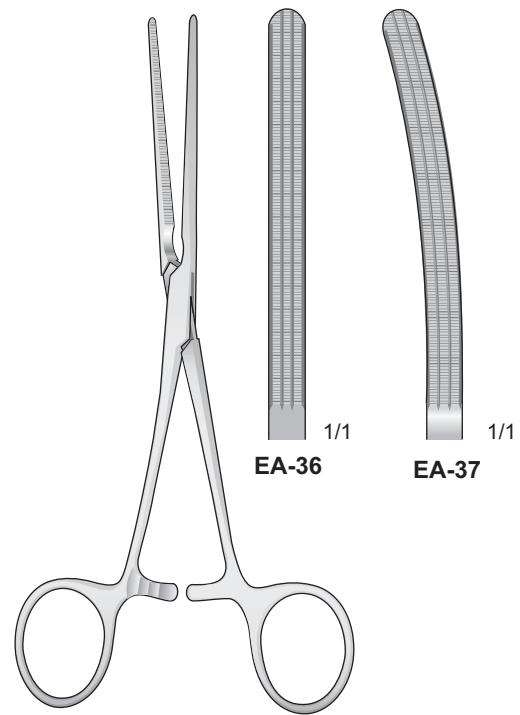

DOYEN
EA-36/EA-37
170 mm

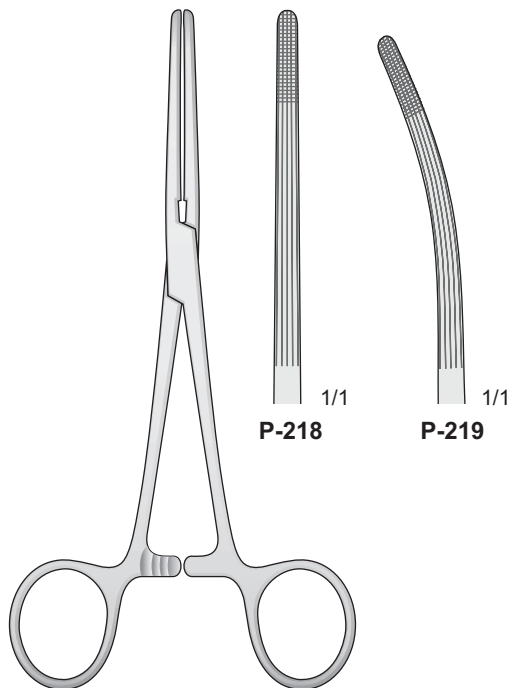

ROCHESTER-CARMALT
P-218/P-219
160 mm

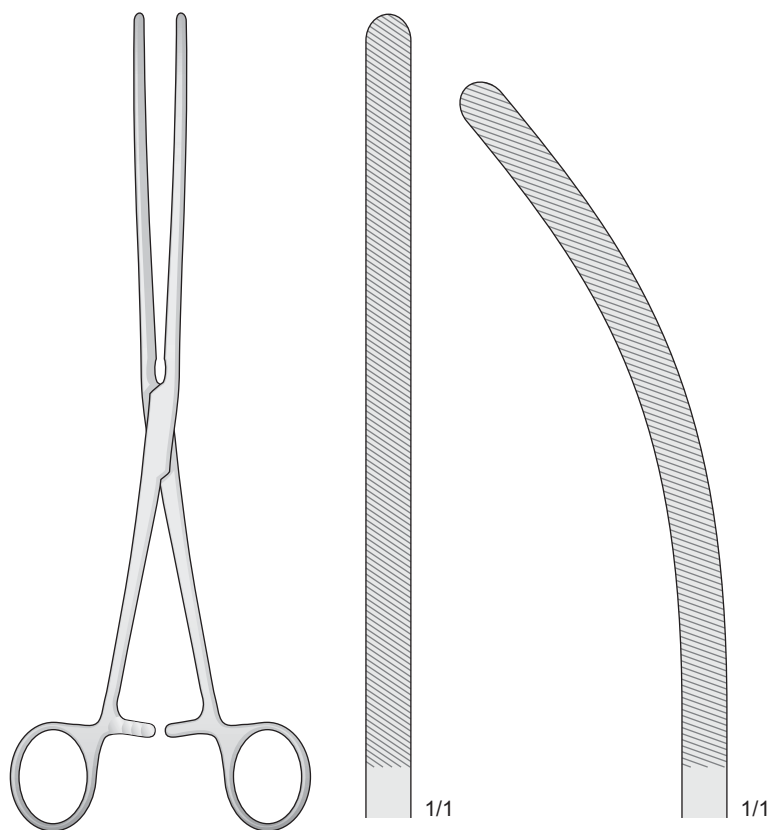

DOYEN
EA-32/EA-33
230 mm

Elastiche - Elastisch - Elastich - Elastic - Elasticas

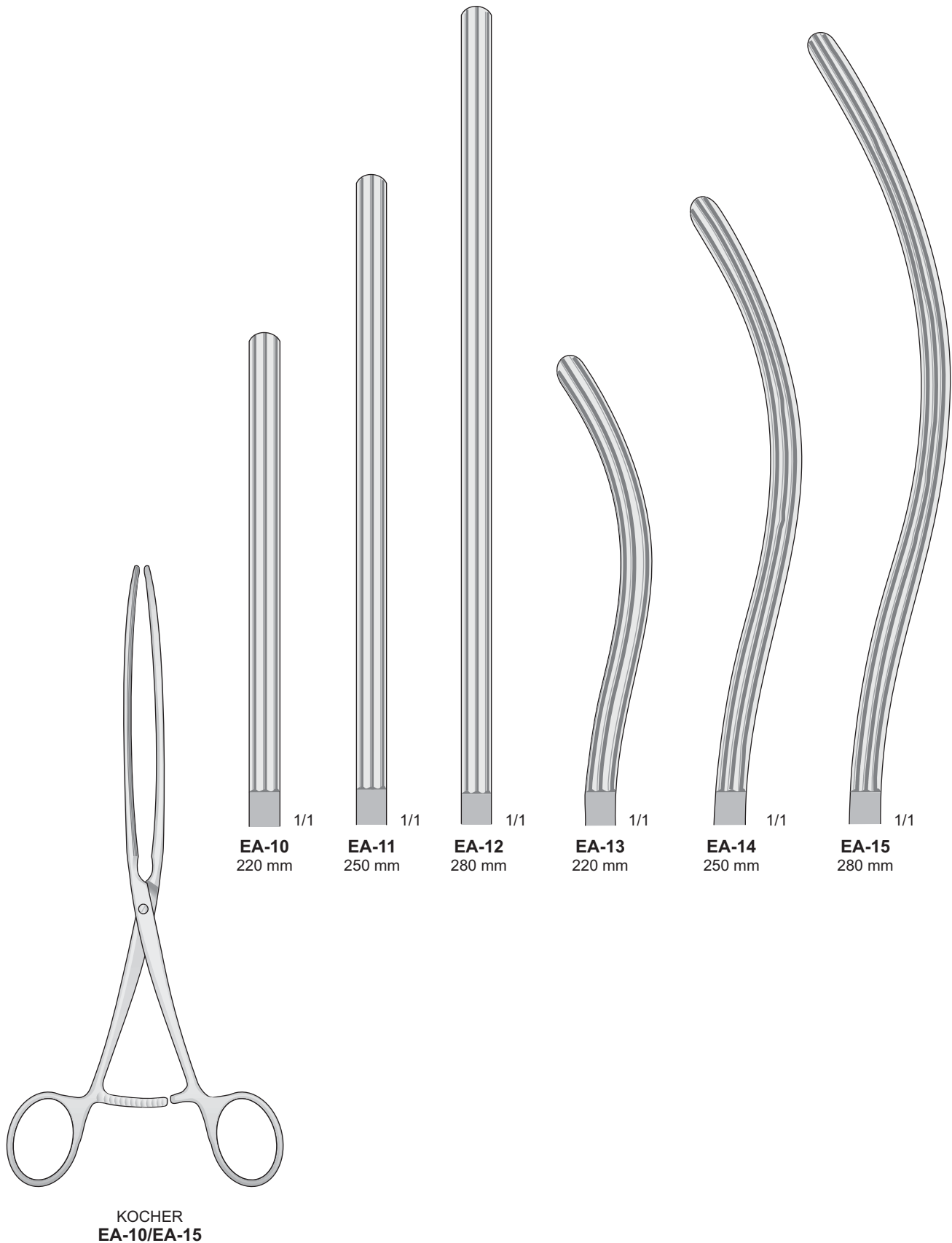

Atraumatiche - Atraumatic
Atraumatische - Atraumatiques - Atraumáticas

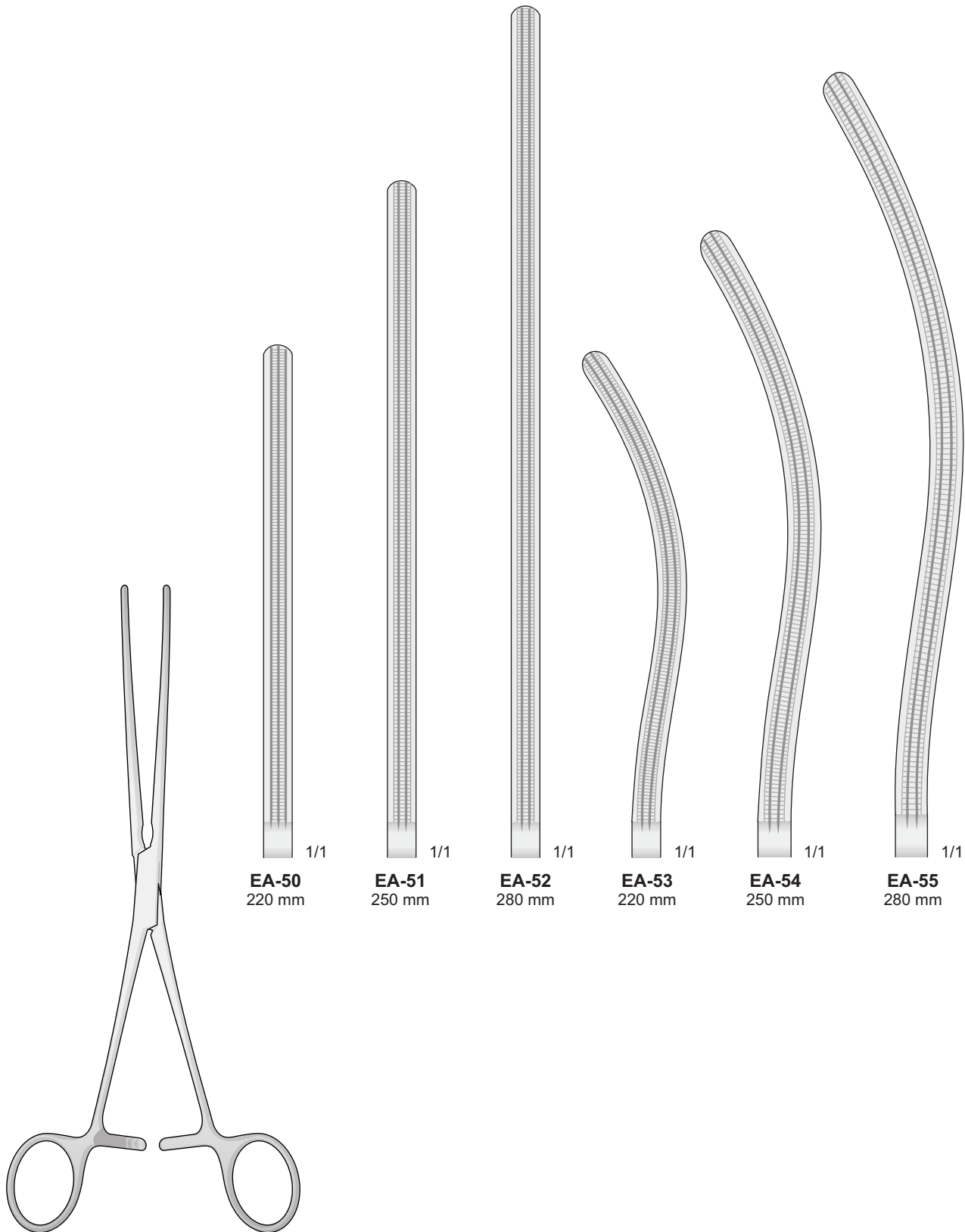

EA-50
220 mm

EA-51
250 mm

EA-52
280 mm

EA-53
220 mm

EA-54
250 mm

EA-55
280 mm

KOCHER
EA-50/EA55

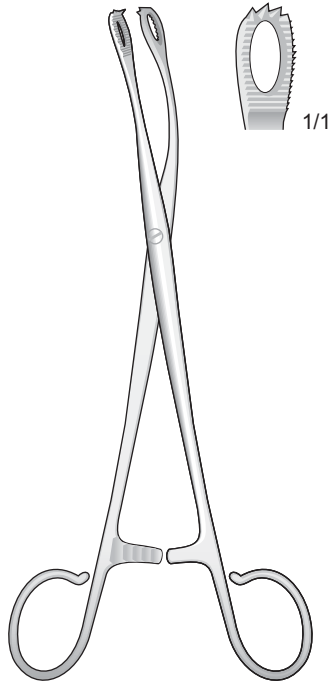

**BLOHMKE
P-220**
200 mm

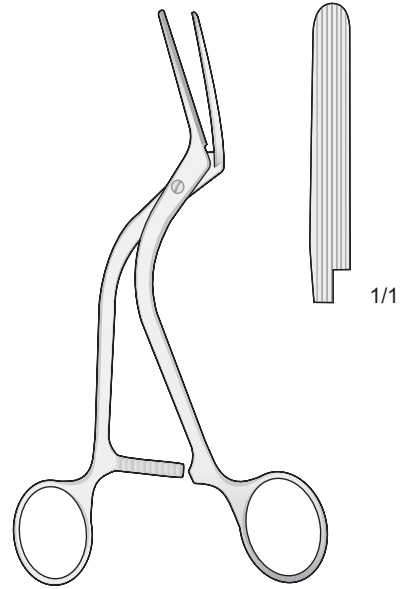

**HÖPFNER
P-07**
165 mm

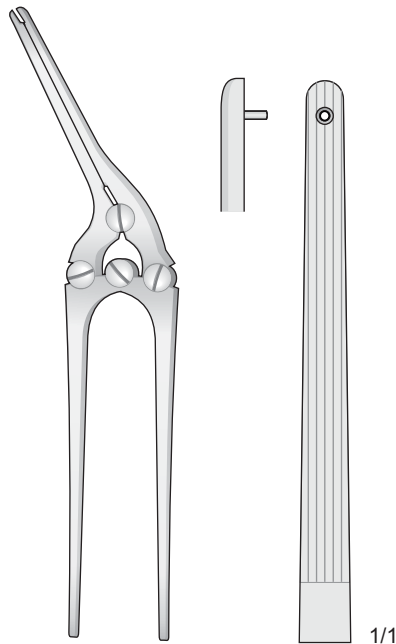

**PAYR
EA-20**
200 mm

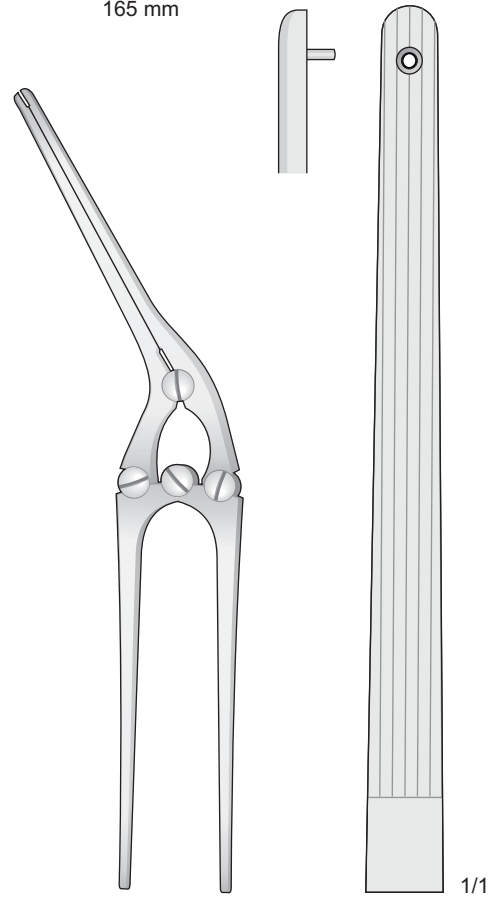

**PAYR
EA-21**
280 mm

06

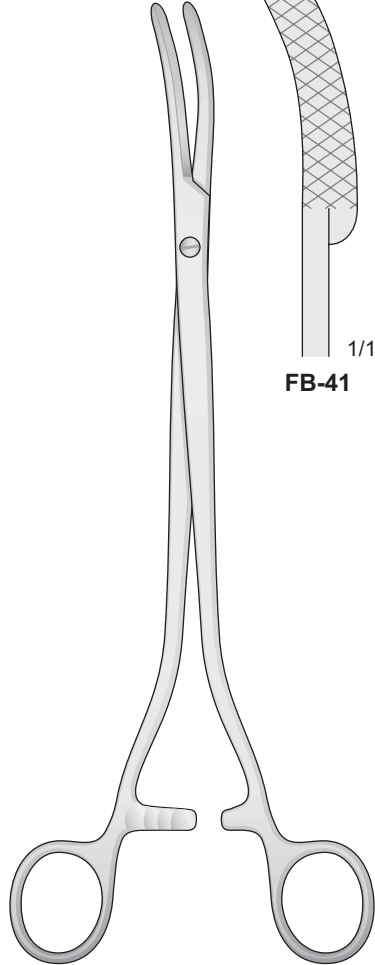

WERTHEIM
FB-41
260 mm

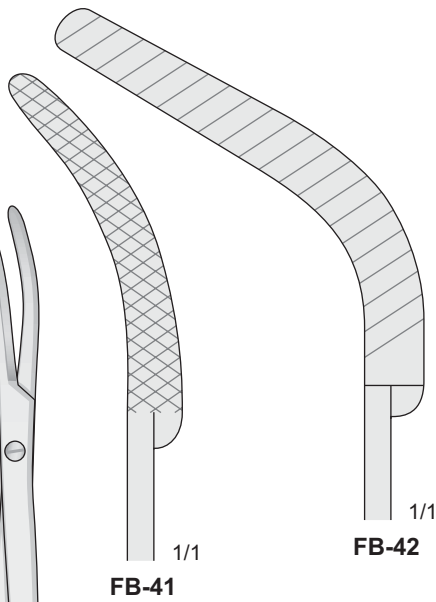

1/1
FB-41

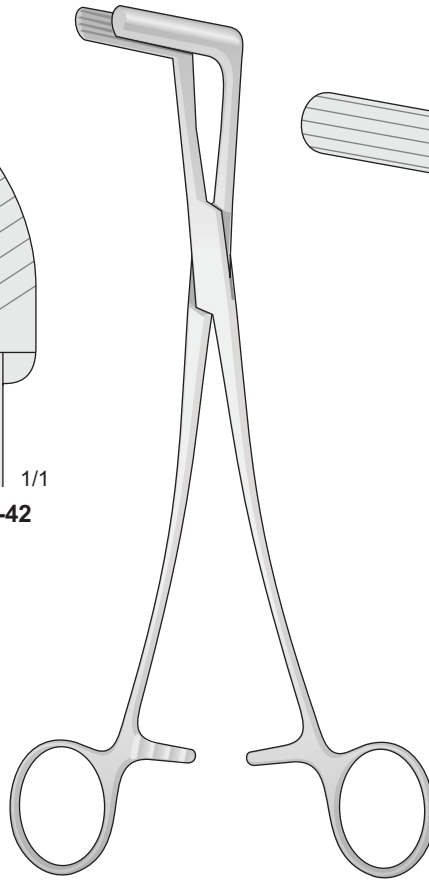

WERTHEIM
FB-42/FB-43
235 mm

1/1
FB-42

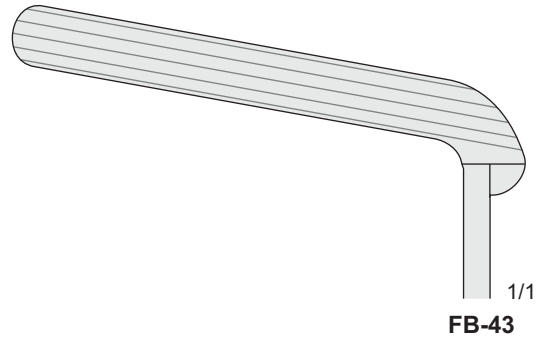

1/1
FB-43

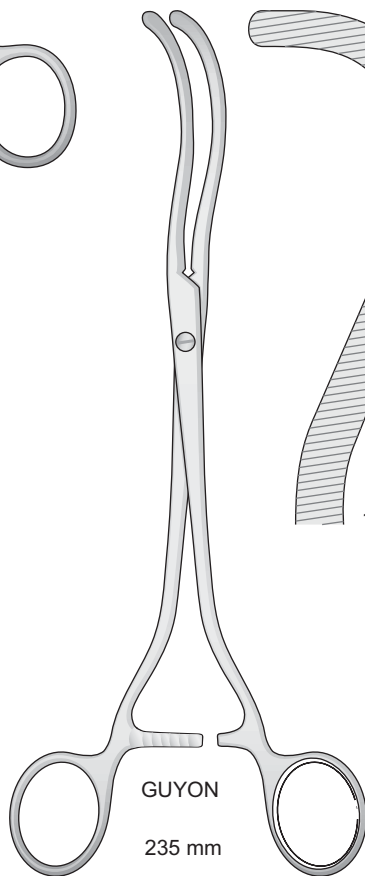

GUYON
235 mm

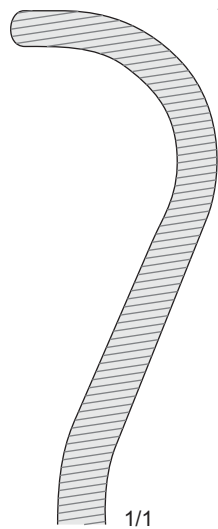

1/1

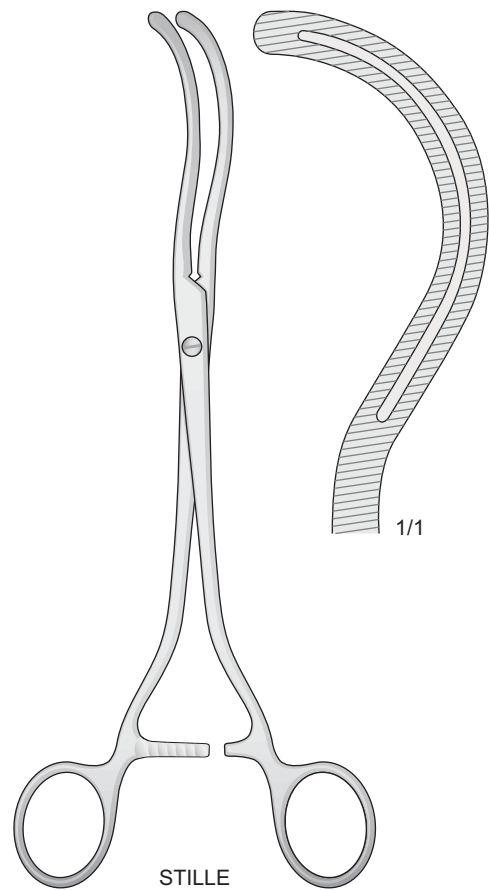

STILLE
EB-32
240 mm

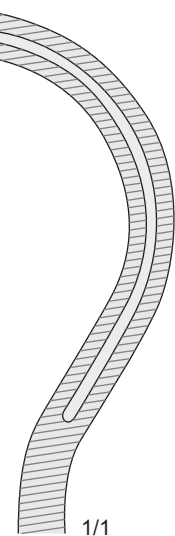

1/1

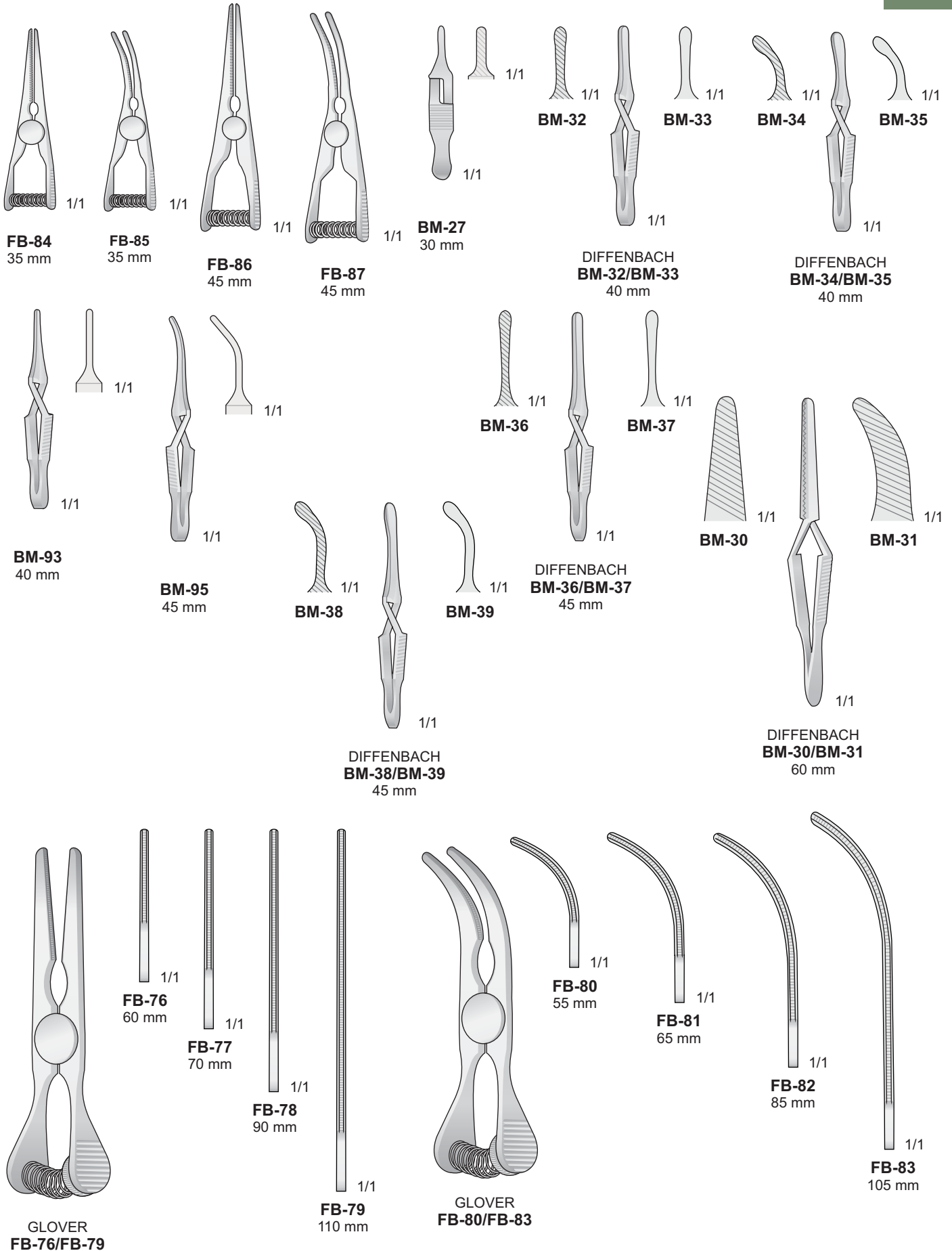

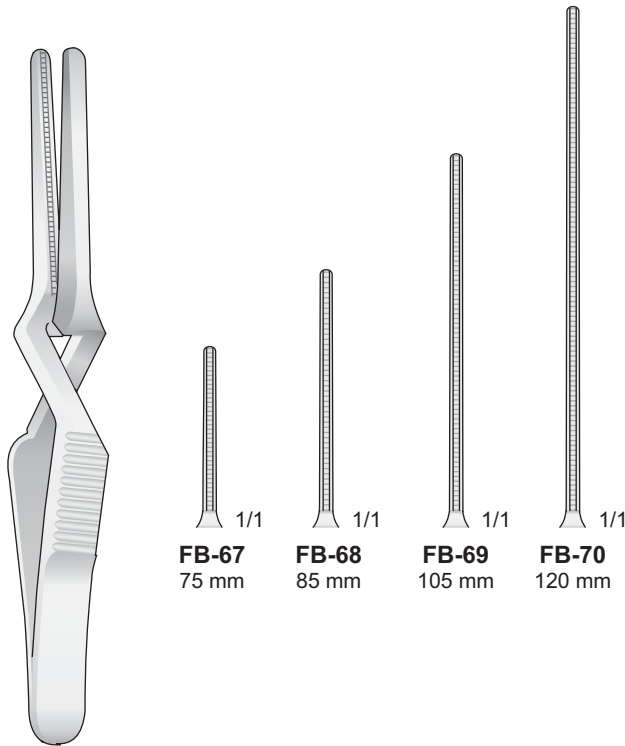

FB-67 75 mm
FB-68 85 mm
FB-69 105 mm
FB-70 120 mm

Pinza per applicare e rimuovere Bulldog clamps
Zange zum ansetzen der Bulldogklemmen
Forceps for applying and removing Bulldog clamps
Pinces pour applicateur clamps Bulldog
Pinzas de aplicación para pinzas Bulldog

FB-67/FB-70

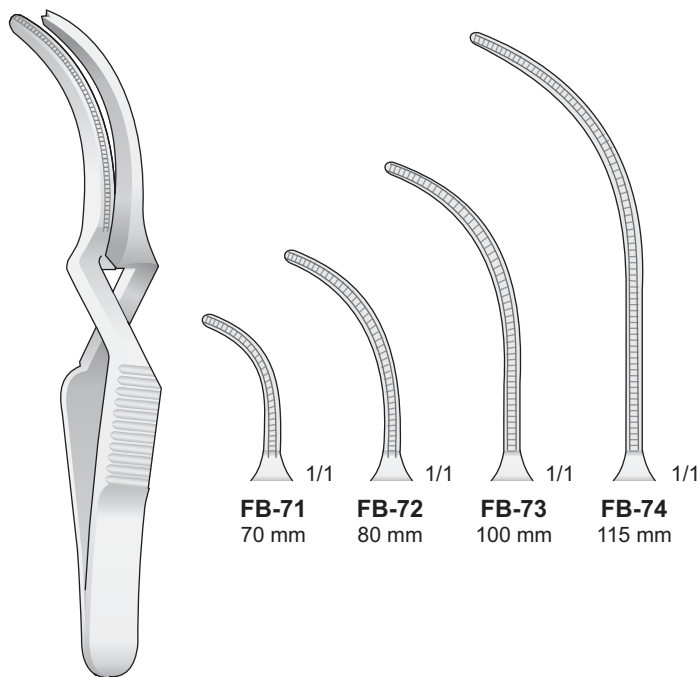

FB-71 70 mm
FB-72 80 mm
FB-73 100 mm
FB-74 115 mm

FB-71/FB-74

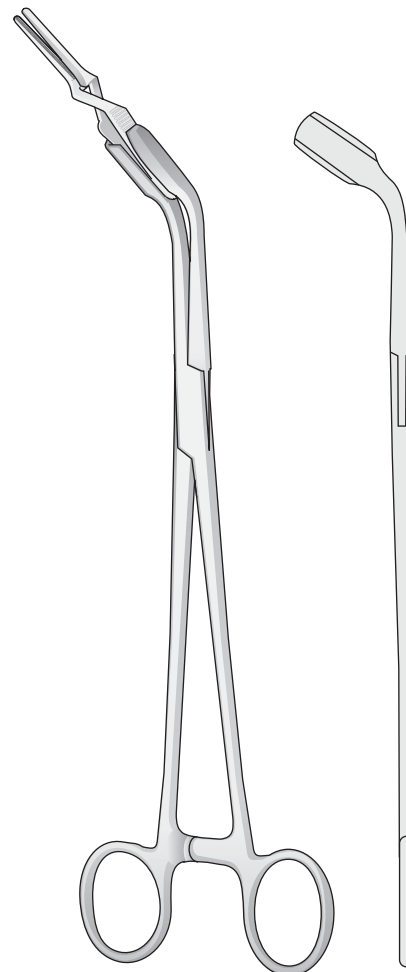

FB-75
230 mm

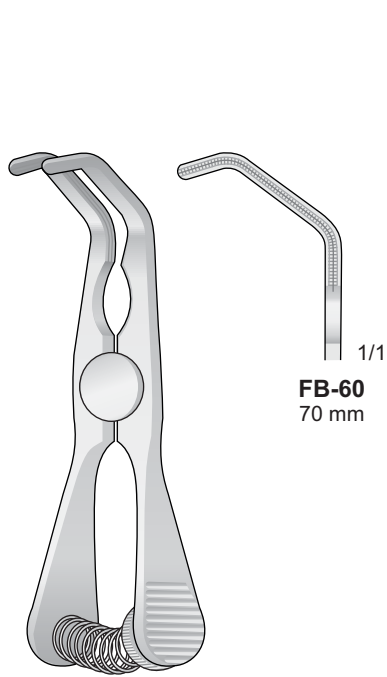

DE BAKEY-SATINSKY
FB-60
70 mm

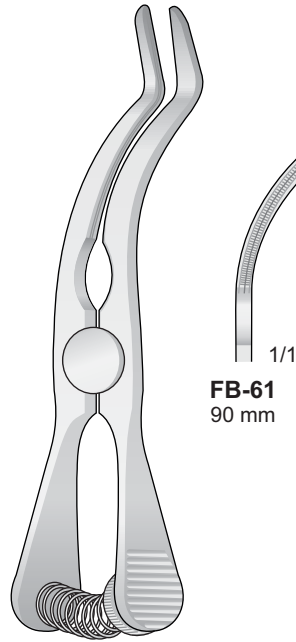

DE BAKEY-CAROTIS
FB-61
90 mm

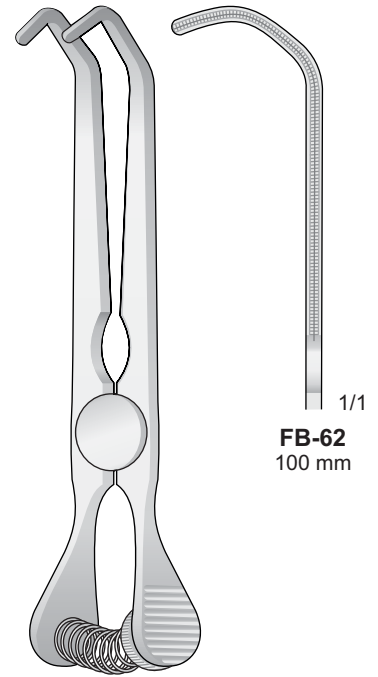

DE BAKEY-SATINSKY
FB-62
100 mm

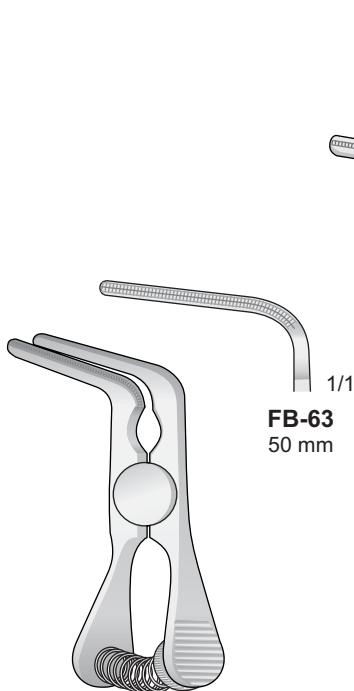

GLOVER
FB-63
50 mm

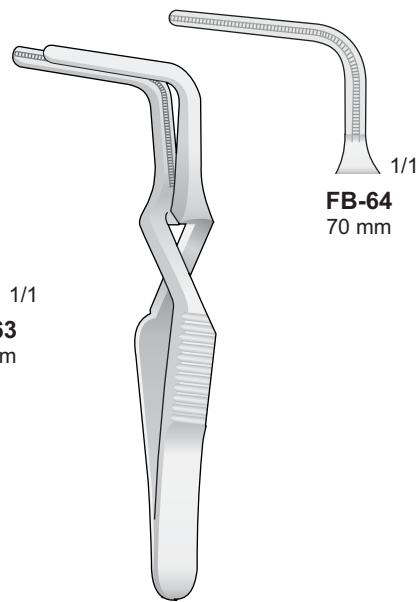

SANTULLI
FB-64
70 mm

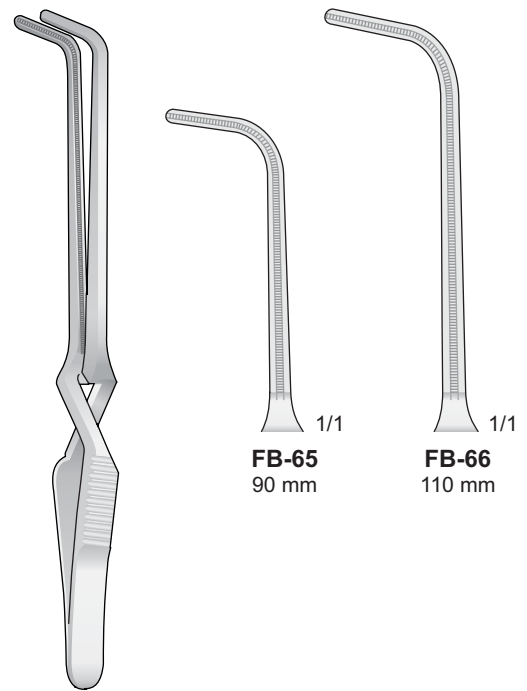

FB-65/FB-66

Pinze atraumatiche per neonati e bambini
Atraumatic Vessel clamps for babies and children
Atraumatische Gefäßklemmen für Säuglinge und Kinder
Pinces vasculaires atraumatiques pour enfants
Pinzas vasculares atraumáticas para niños

Modelli estremamente fini
Delicate - Fein - Fins - Finas

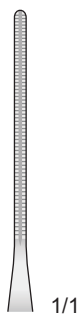

FB-241
140 mm

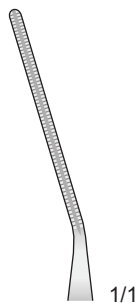

FB-242
140 mm

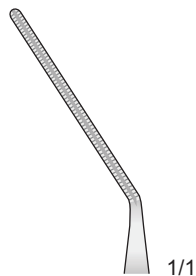

FB-243
140 mm

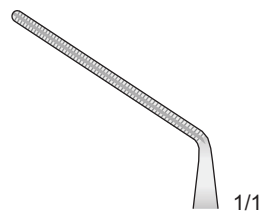

FB-244
130 mm

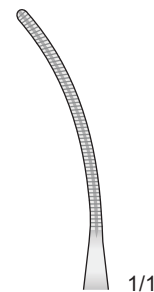

FB-245
140 mm

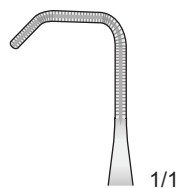

FB-246
130 mm



FB-247
130 mm

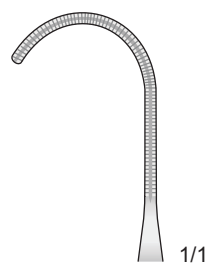

FB-248
140 mm

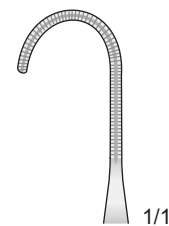

FB-249
135 mm

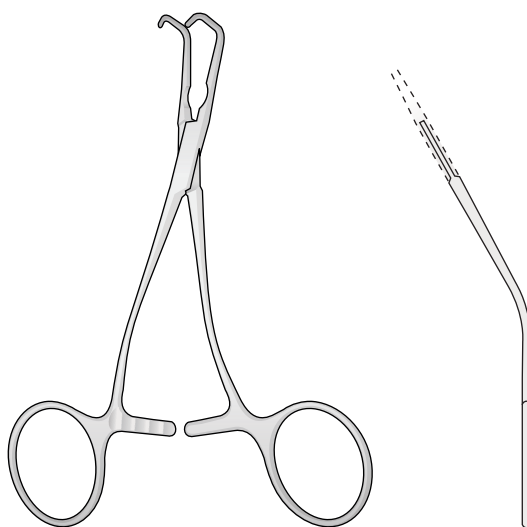

FB-241/FB249
130 mm

Atraumatiche
Atraumatic
Atraumatische
Atraumatiques
Atraumaticas

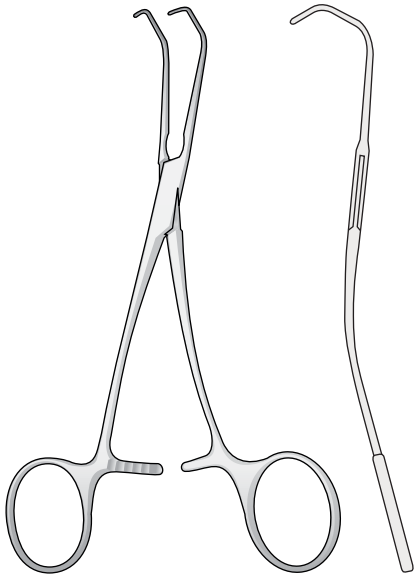

CASTANEDA
FB-236/FB-239
155 mm

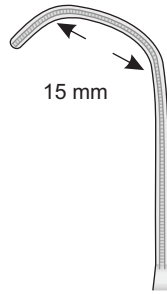

FB-236
48 mm

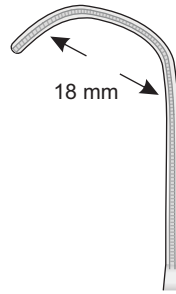

FB-237
52 mm

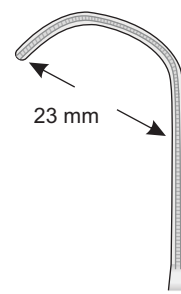

FB-238
56 mm

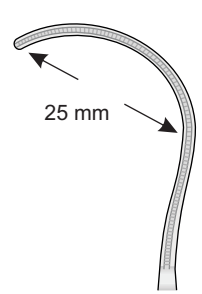

FB-239
50 mm

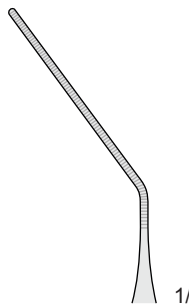

FB-251

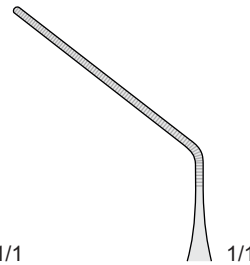

FB-252

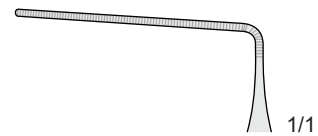

FB-253

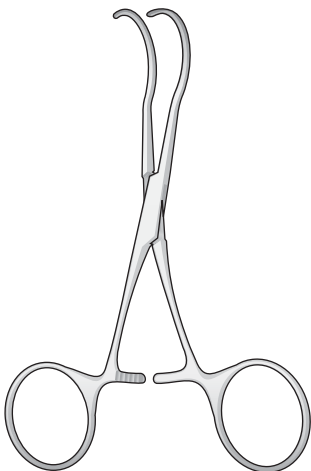

CASTANEDA
FB-251/FD-257
120 mm

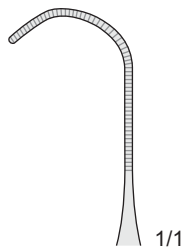

FB-254

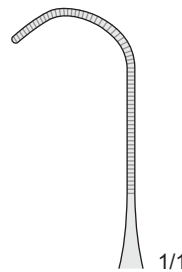

FB-255

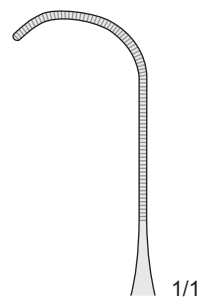

FB-256

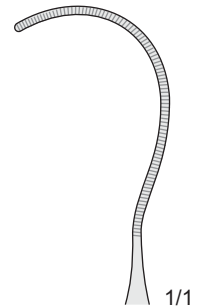

FB-257

Pinze per neonati e bambini
Atraumatic vessel clamps for babies and children
Säugling - und Kinderklemmen
Pinces-clamps pour nouveaux-nés et enfants
Pinzas vasculares atraumáticas para niños

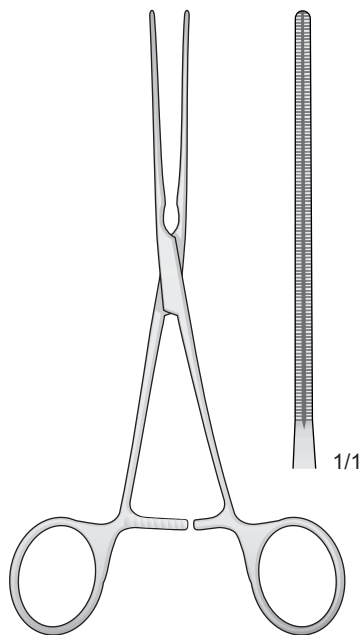

FB-211
165 mm

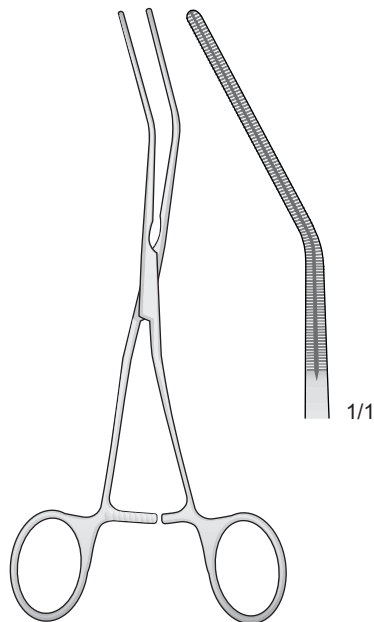

FB-212
160 mm

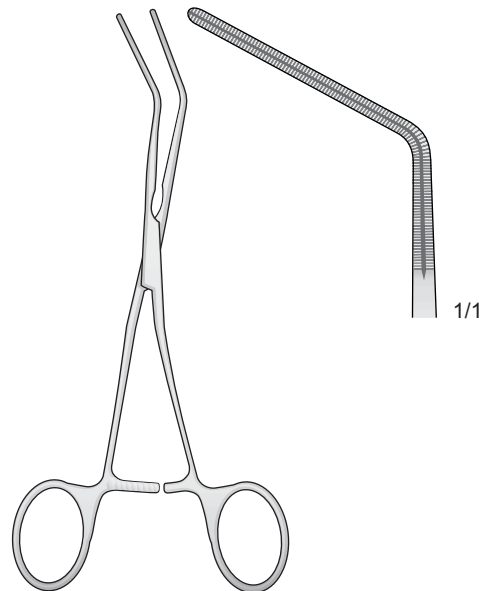

FB-213
150 mm

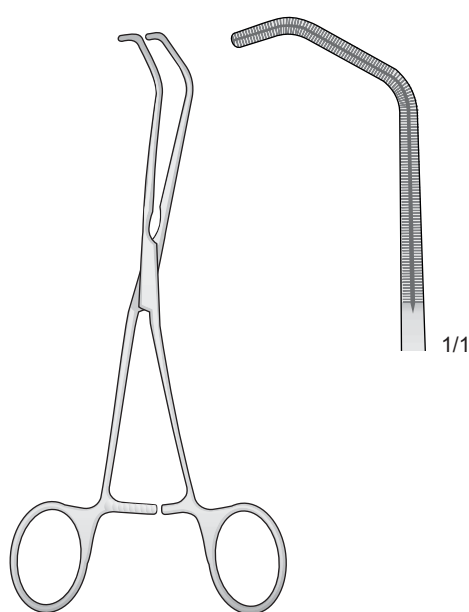

FB-214
150 mm

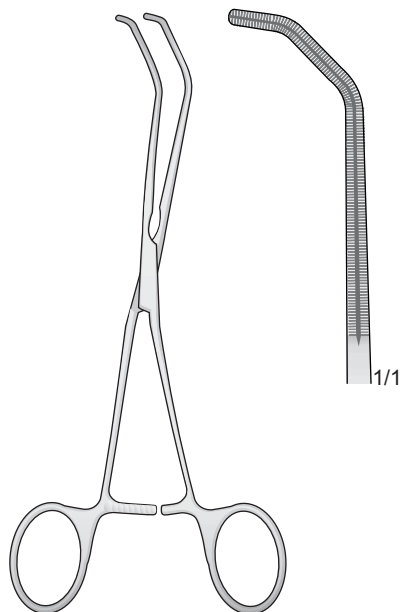

FB-215
155 mm

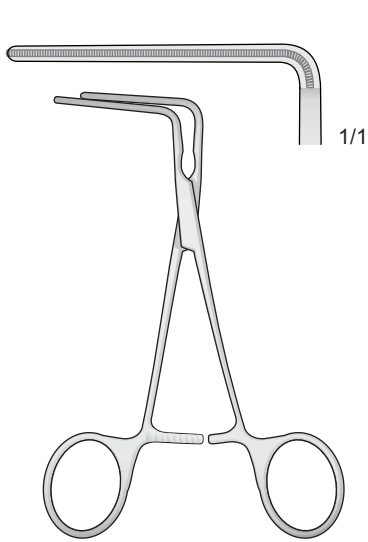

De BAKEY
FB-201
100 mm

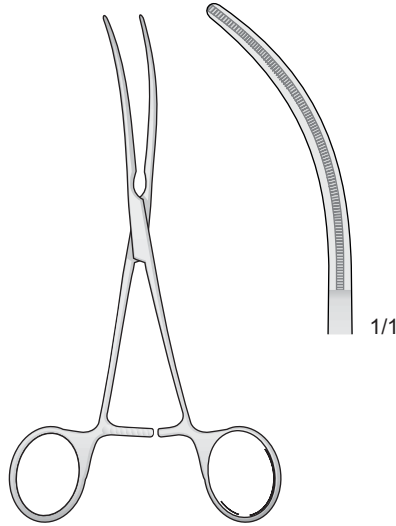

De BAKEY
FB-202
110 mm

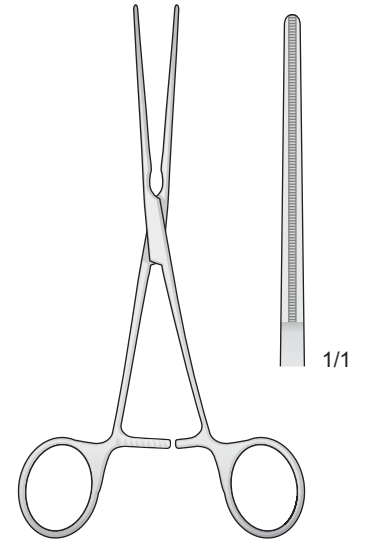

De BAKEY
FB-203
120 mm

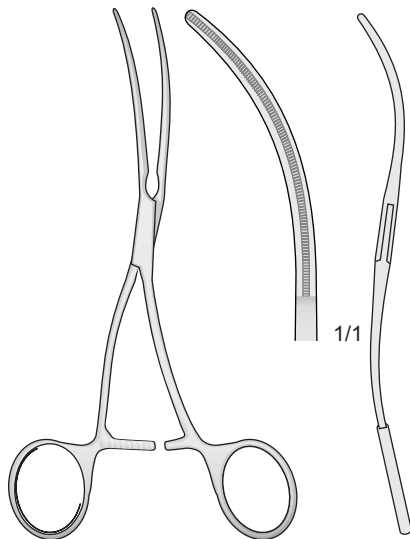

De BAKEY
FB-204
120 mm

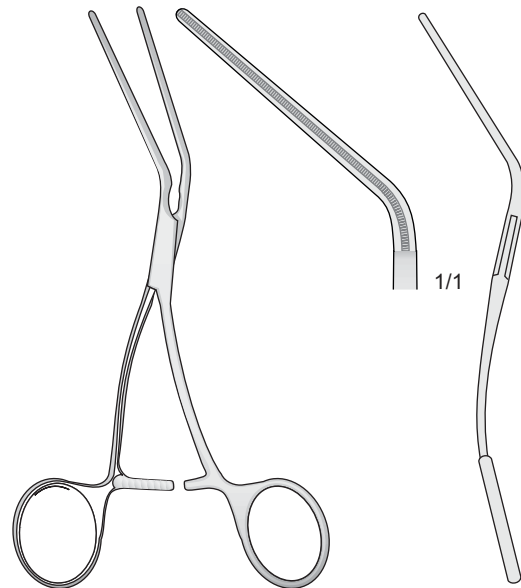

De BAKEY
FB-205
130 mm

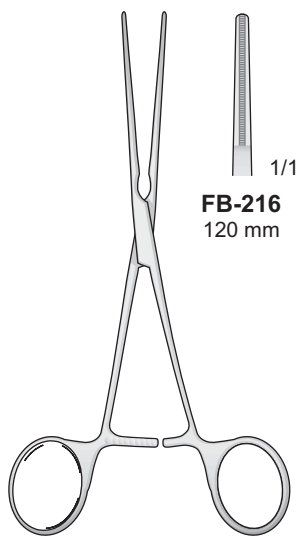

FB-216
120 mm

De BAKEY - MOSQUITO
FB-216
120 mm

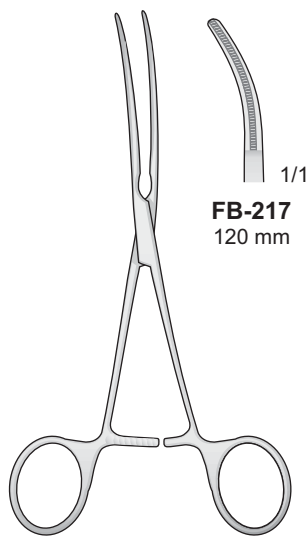

FB-217
120 mm

De BAKEY - MOSQUITO
FB-217
120 mm

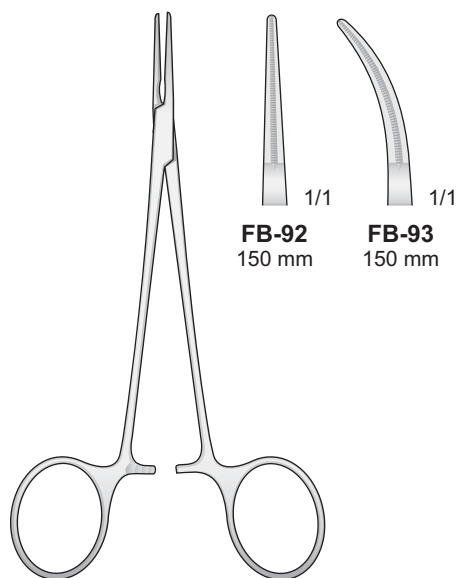

FB-92
150 mm

FB-93
150 mm

De BAKEY - MOSQUITO
FB-92/FB-93
150 mm

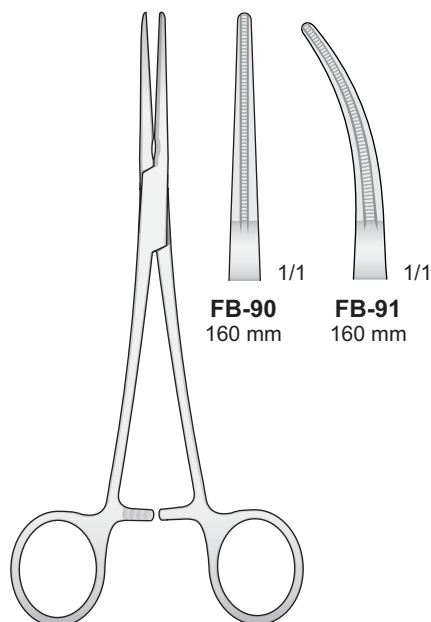

FB-90
160 mm

FB-91
160 mm

De BAKEY - RANKIN
FB-90/FB-91
160 mm

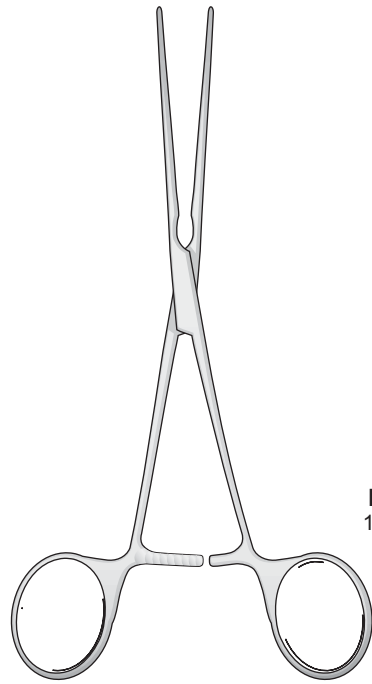

De BAKEY - PEAN
FB-45/FB-49

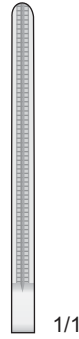

FB-45
140 mm

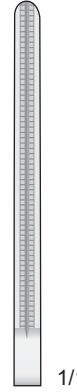

FB-47
160 mm

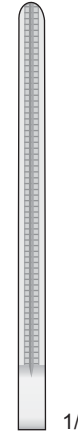

FB-48
180 mm

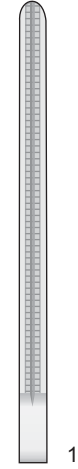

FB-49
200 mm

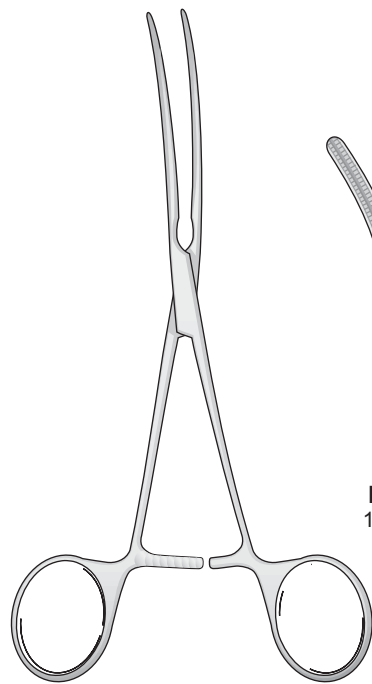

De BAKEY - PEAN
FB-55/FB-59

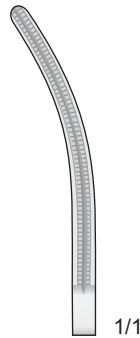

FB-55
140 mm

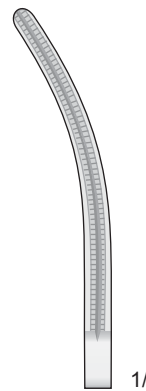

FB-57
160 mm

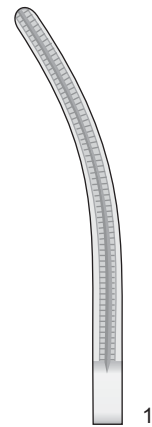

FB-58
180 mm

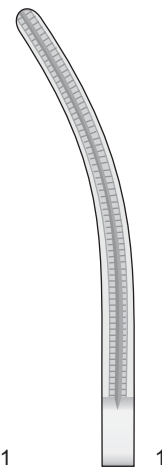

FB-59
200 mm

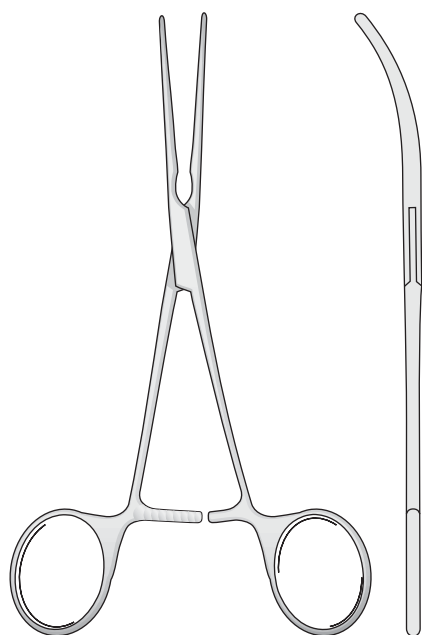

De BAKEY
FB-22/FB-23
165 mm

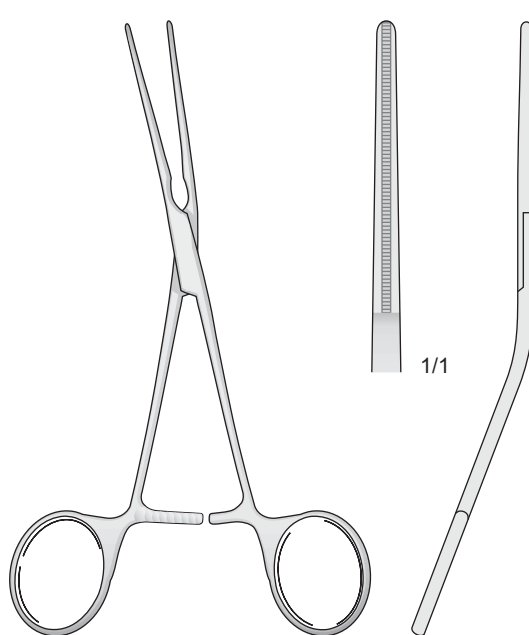
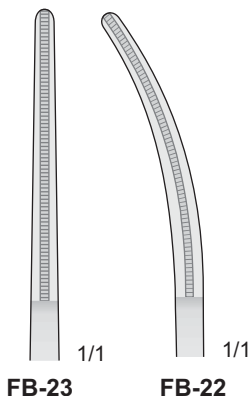

De BAKEY
FB-24
165 mm

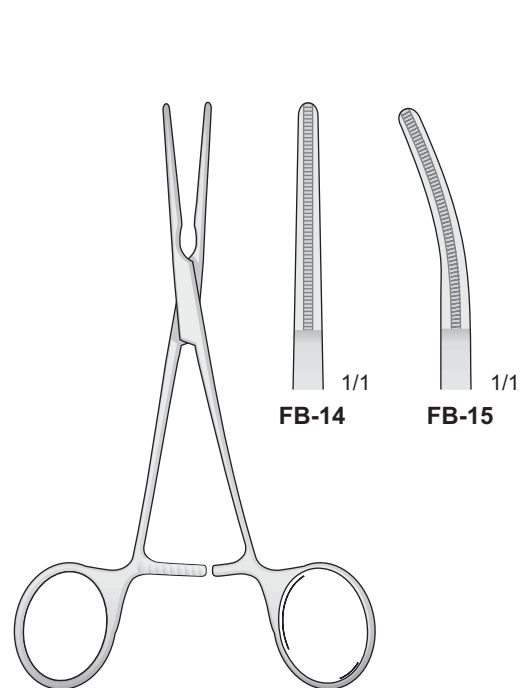

De BAKEY - BAINBRIDGE
FB-14/FB-15
155 mm

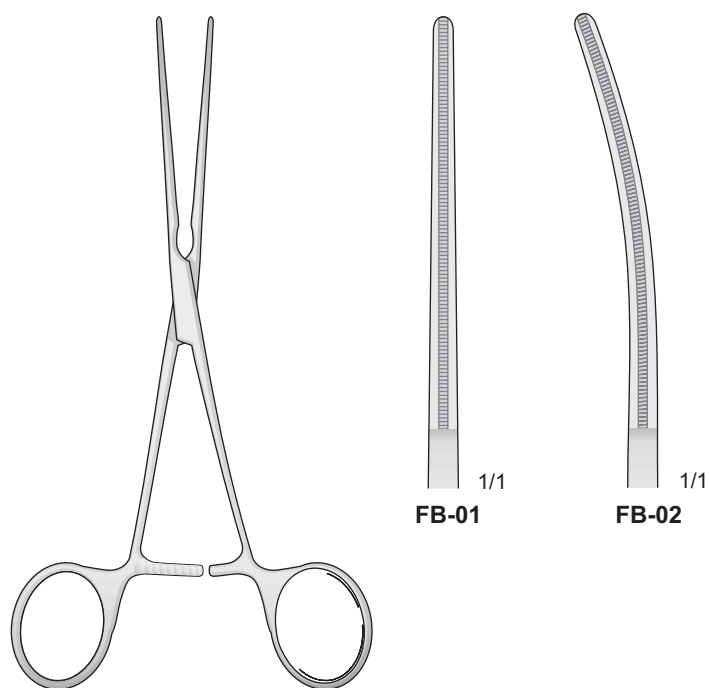
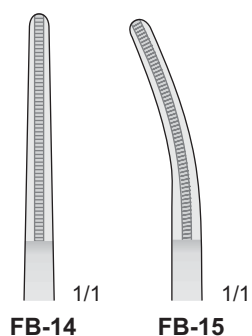

De BAKEY - BAINBRIDGE
FB-01/FB-02
180 mm

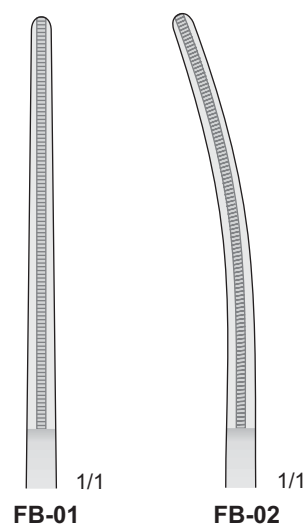

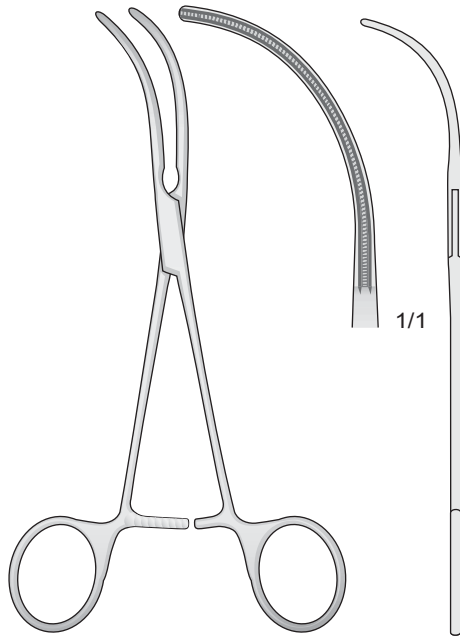

De BAKEY
FB-133
160 mm

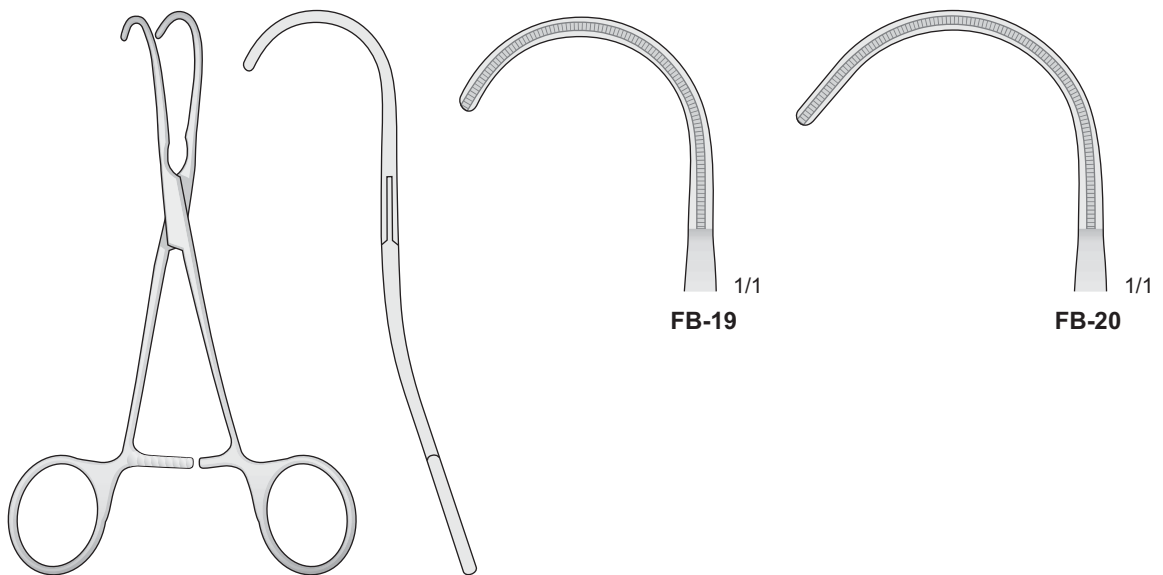

De BAKEY
FB-19/FB-20
150 mm

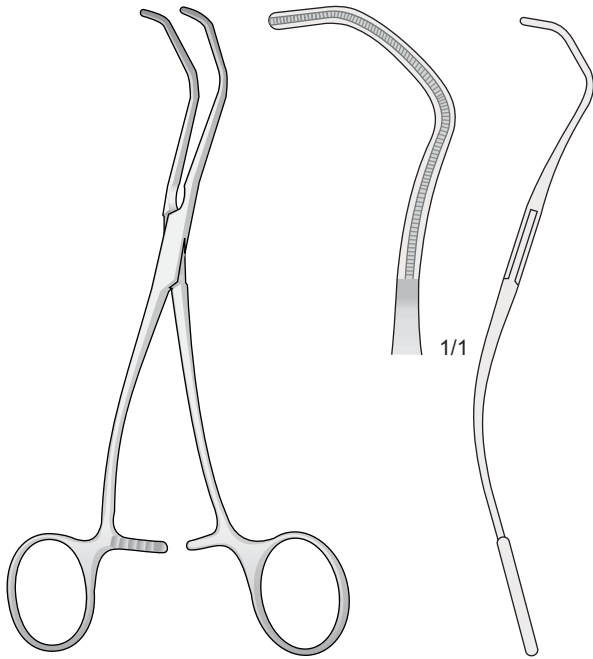

De-BAKEY
FB-191
170 mm

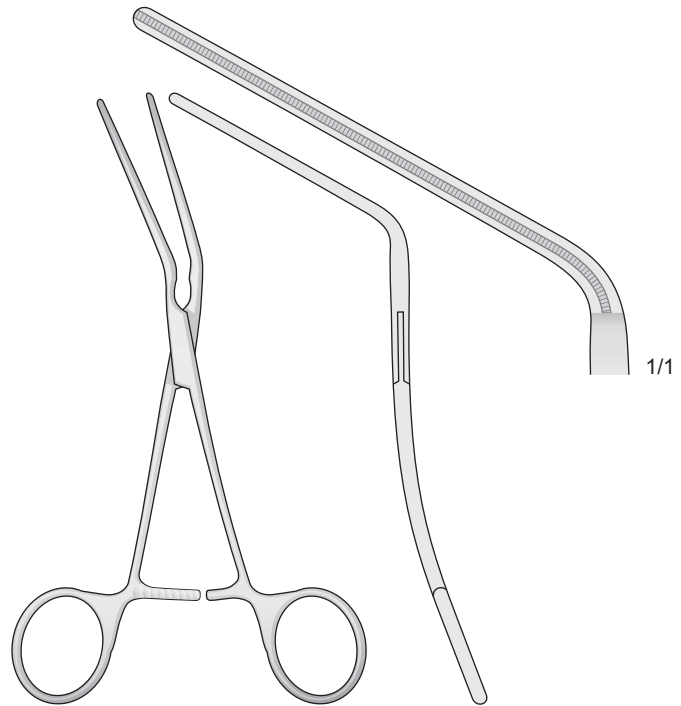

De BAKEY
FB-21
165 mm

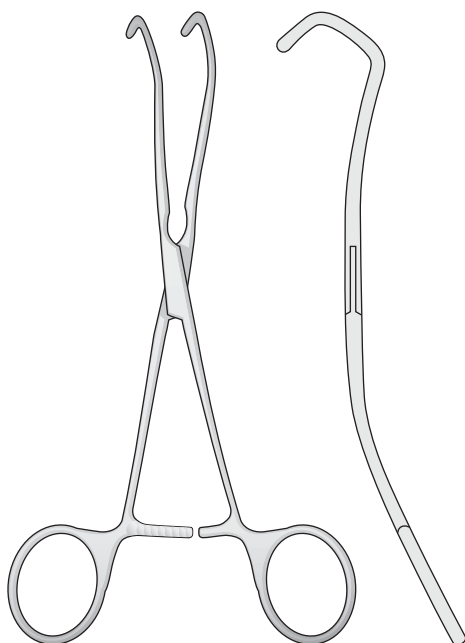

DERRA
FB-03/FB-04
170 mm

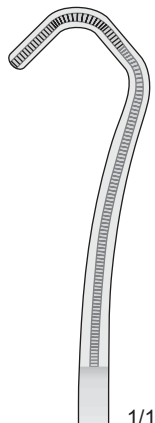

FB-03

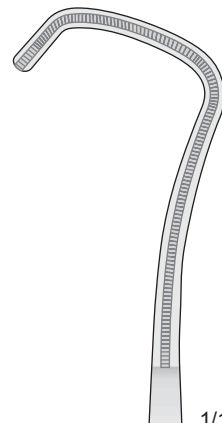

FB-04

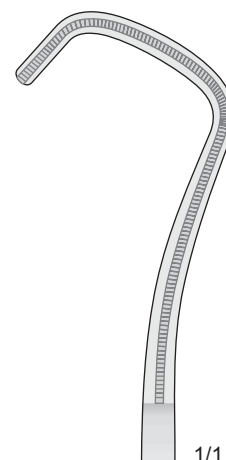

FB-05

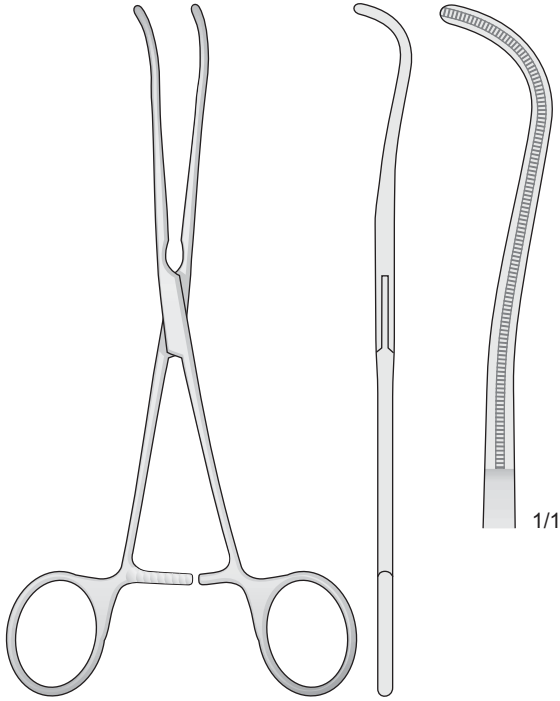

De BAKEY
FB-18
190 mm

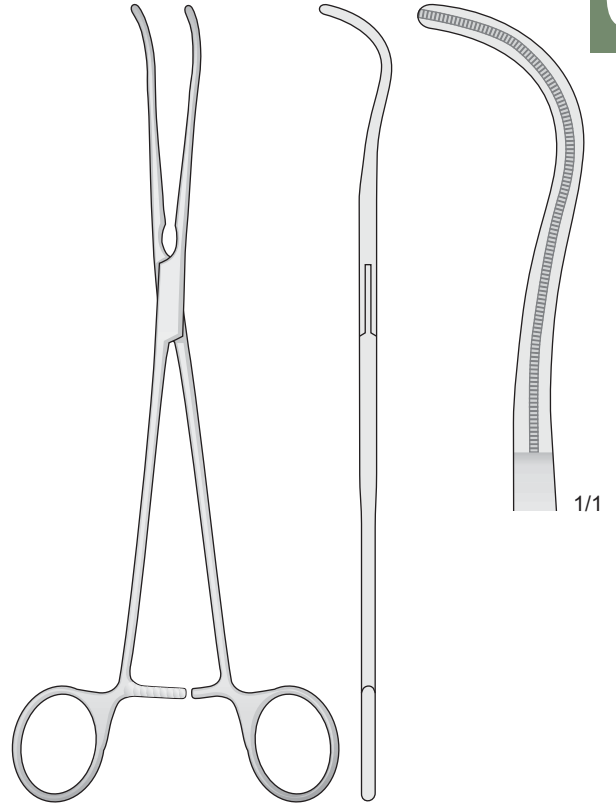

De BAKEY
FB-37
230 mm

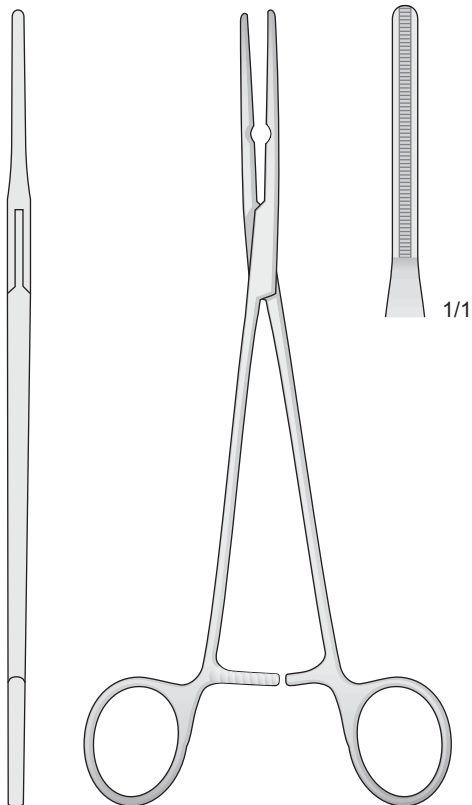

De BAKEY
FB-35
215 mm

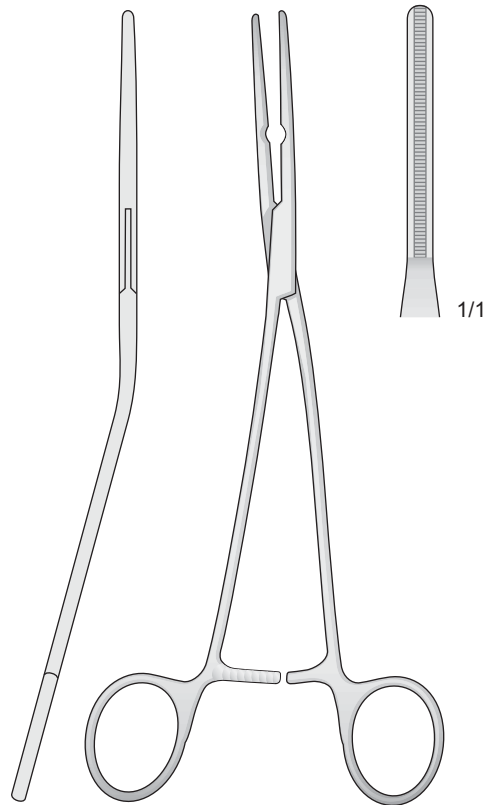

De BAKEY
FB-36
215 mm

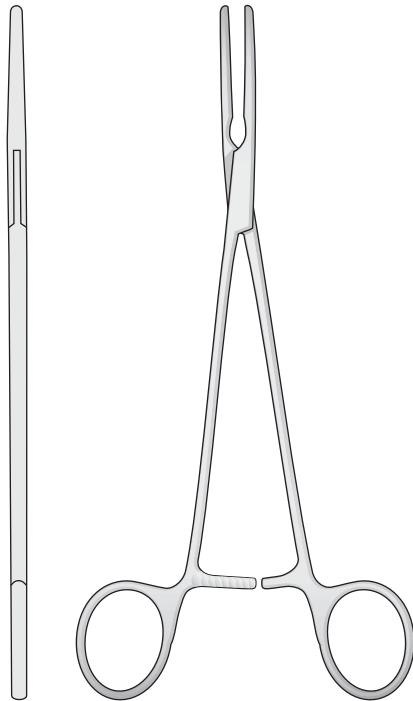

De BAKEY
FB-29/FB-31

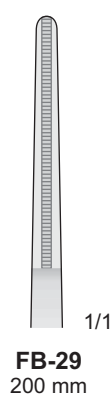

FB-29
200 mm

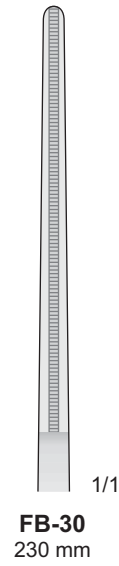

FB-30
230 mm

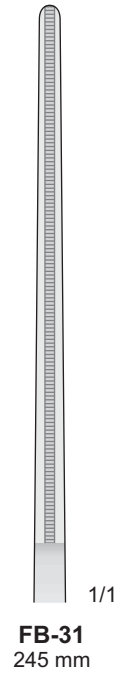

FB-31
245 mm

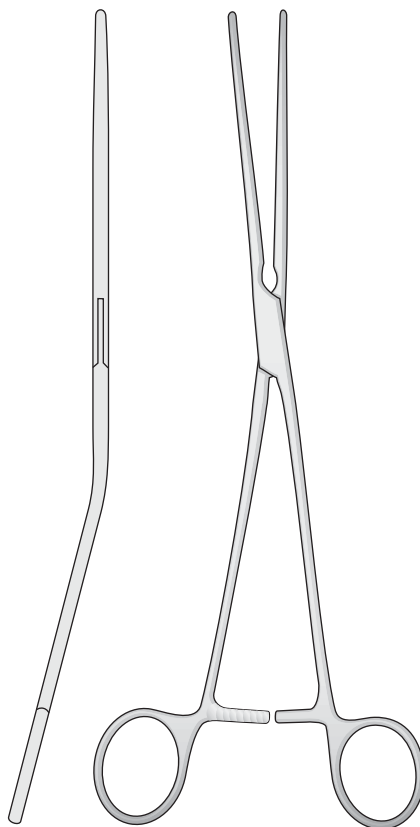

De BAKEY
FB-32/FB-34

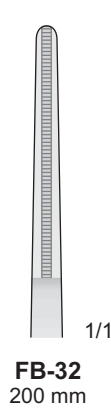

FB-32
200 mm

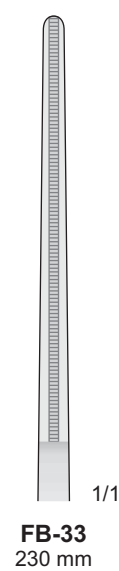

FB-33
230 mm

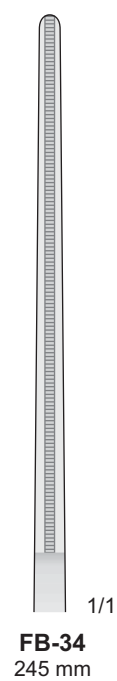

FB-34
245 mm

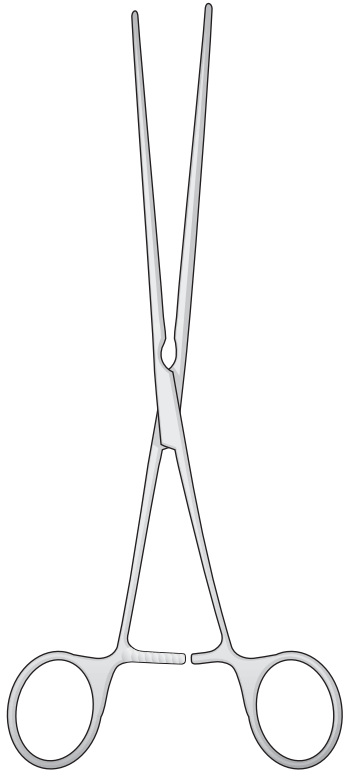

De BAKEY
FB-09
220 mm

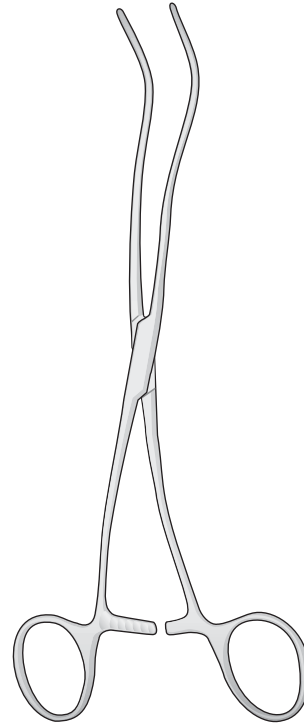
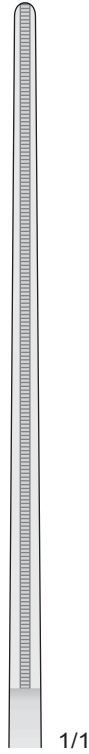

De BAKEY
FB-17
200 mm

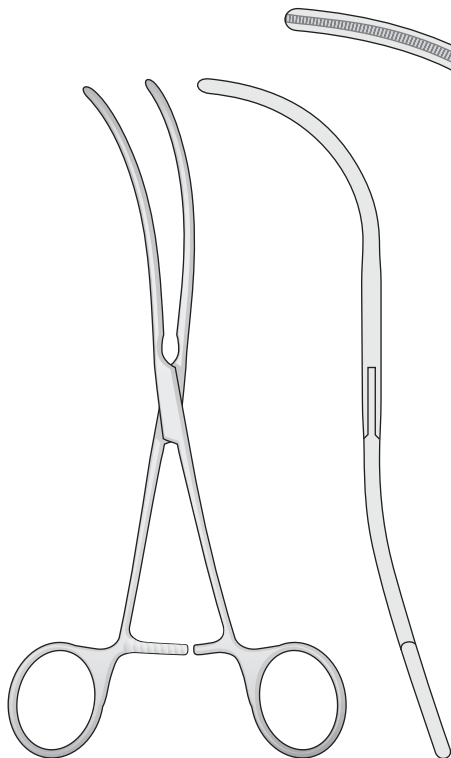
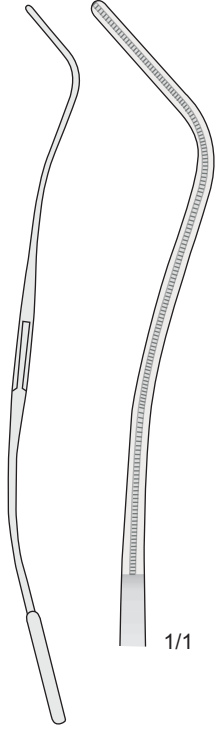

De BAKEY
FB-08
180 mm

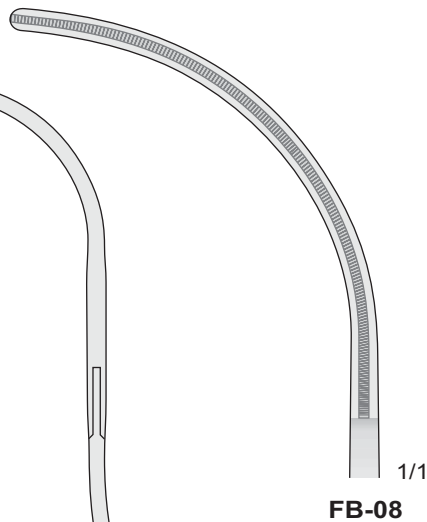

FB-08

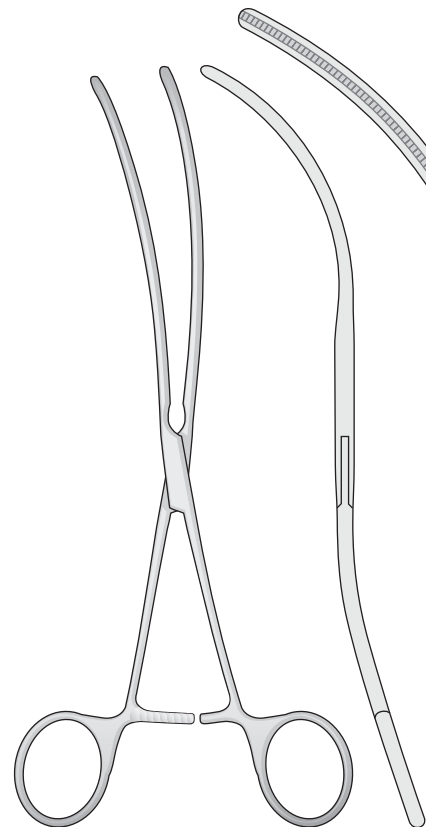

De BAKEY
FB-10
200 mm

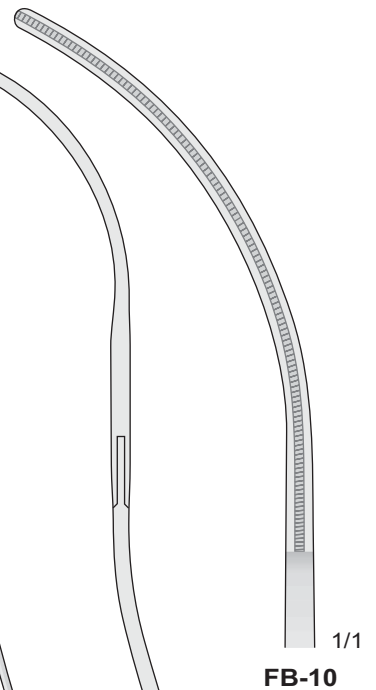

FB-10

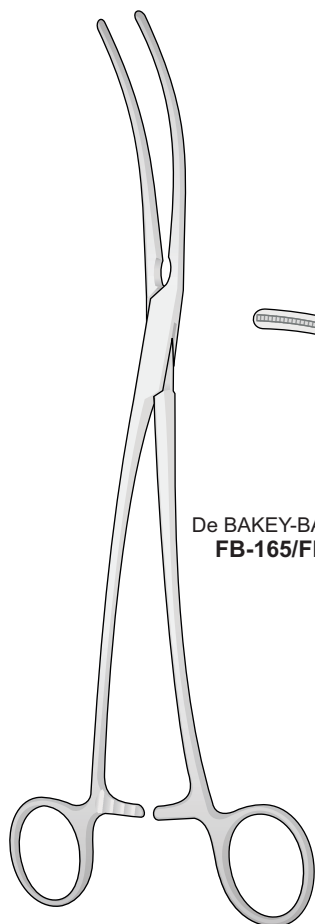

De BAKEY-BAHNSON
FB-165/FB-167

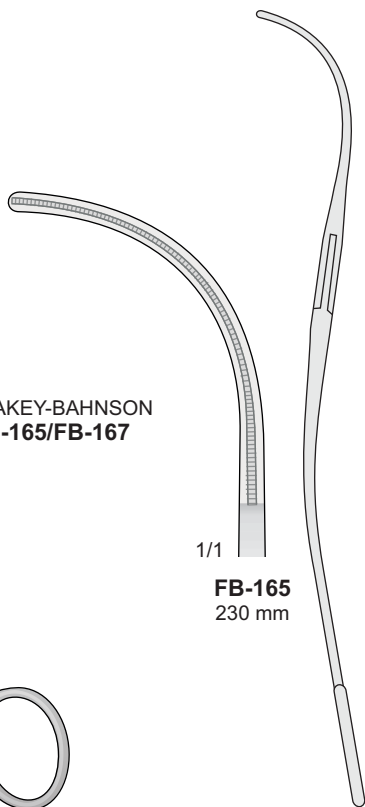

1/1
FB-165
230 mm

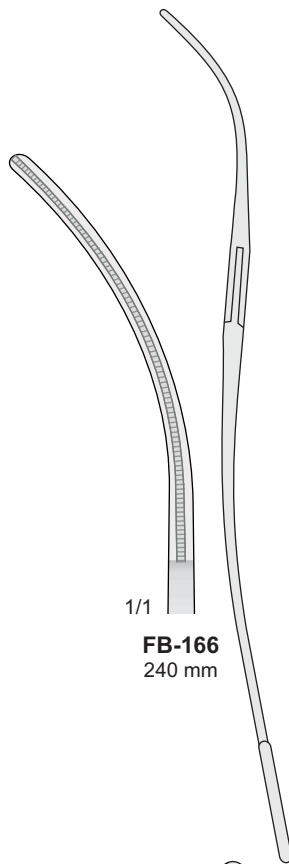

1/1
FB-166
240 mm

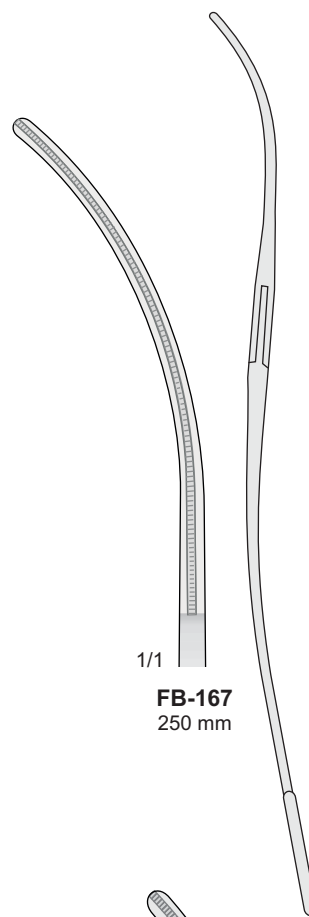

1/1
FB-167
250 mm

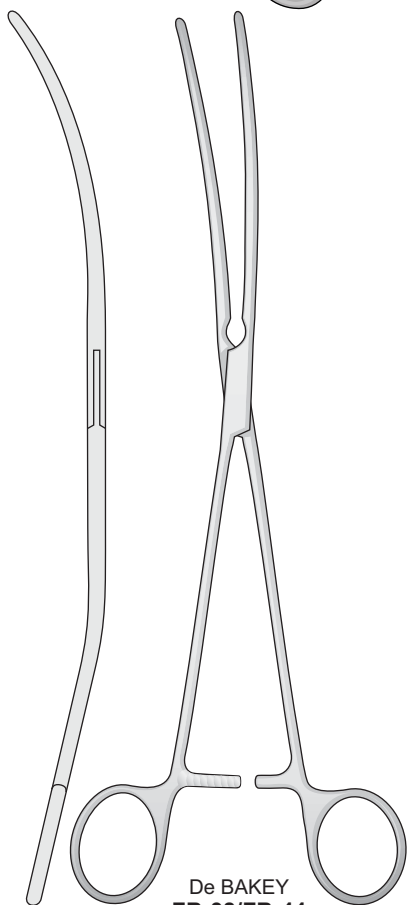

De BAKEY
FB-38/FB-44

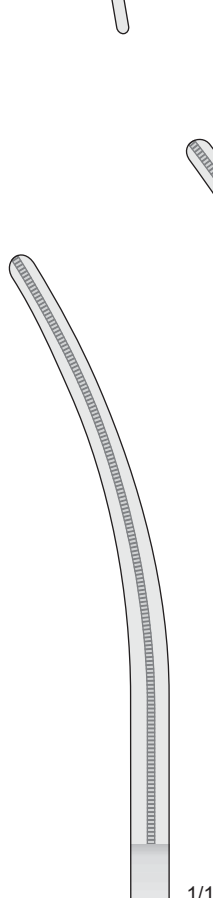

1/1
FB-38
250 mm

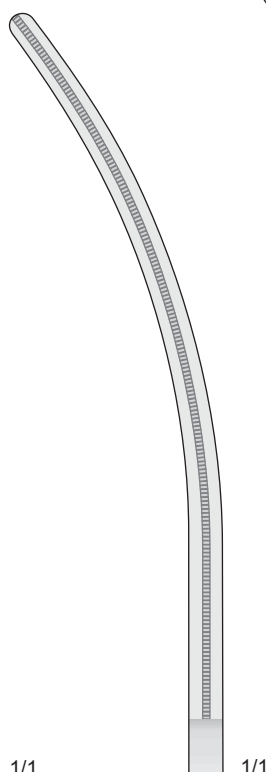

1/1
FB-39
270 mm

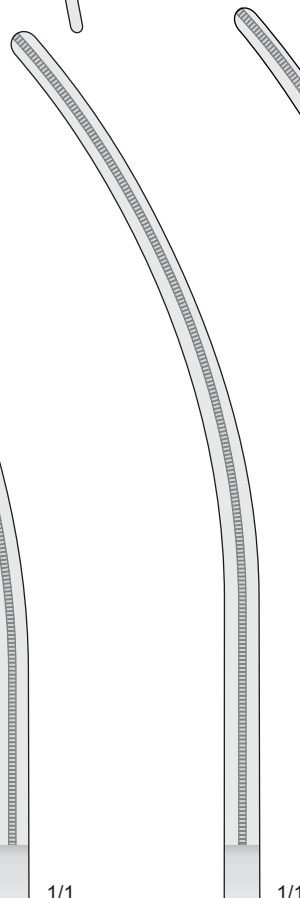

1/1
FB-40
280 mm

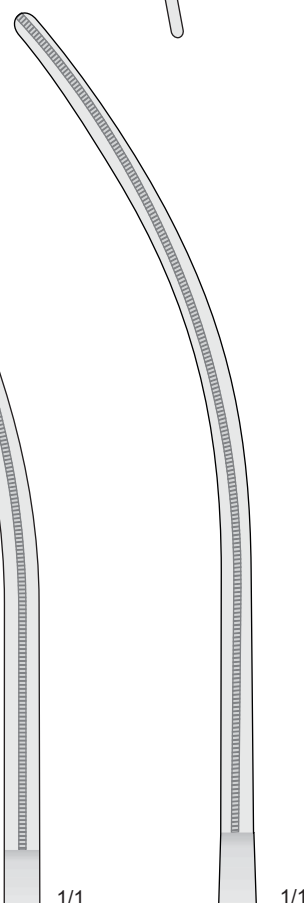

1/1
FB-44
330 mm

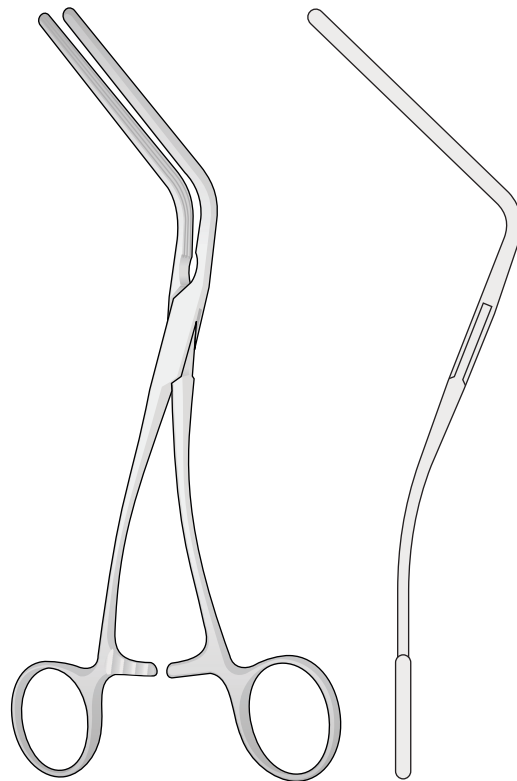
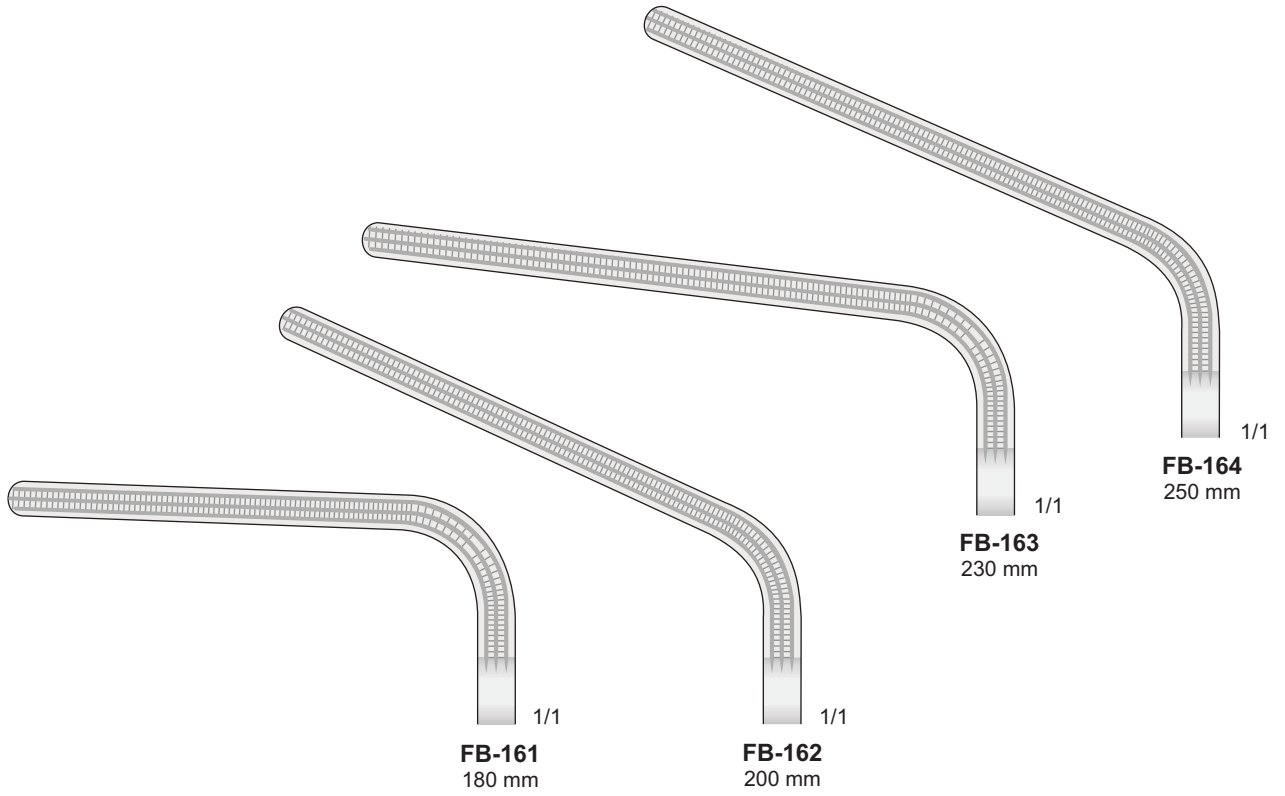

MORRIS-De BAKEY
FB-161/FB-164

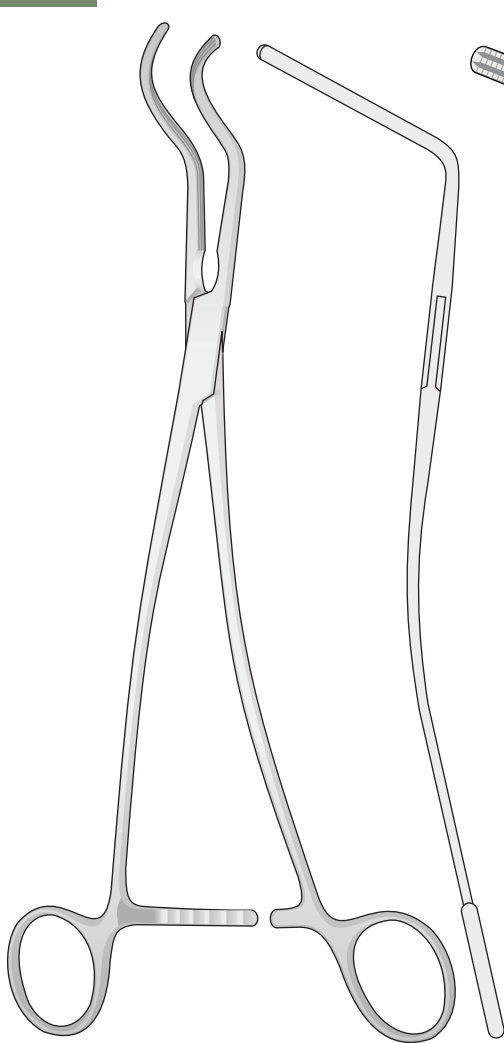

De BAKEY
FB-140
270 mm

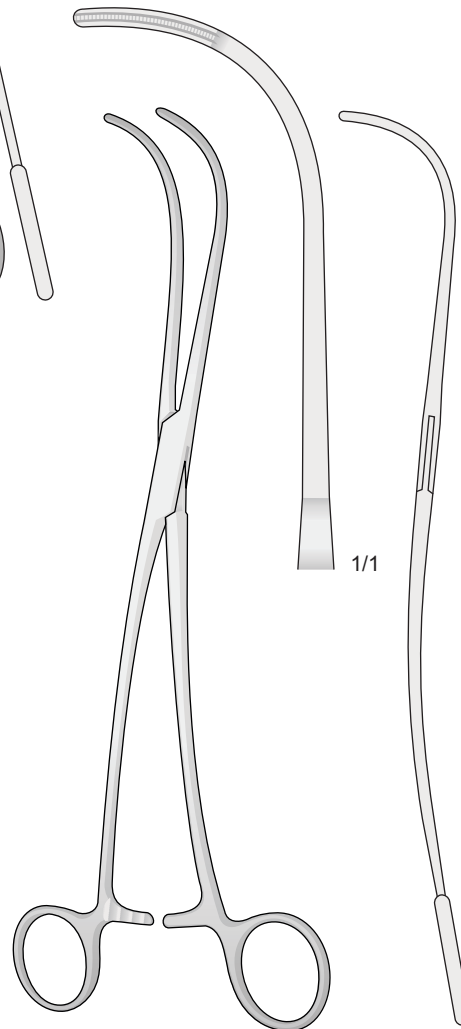
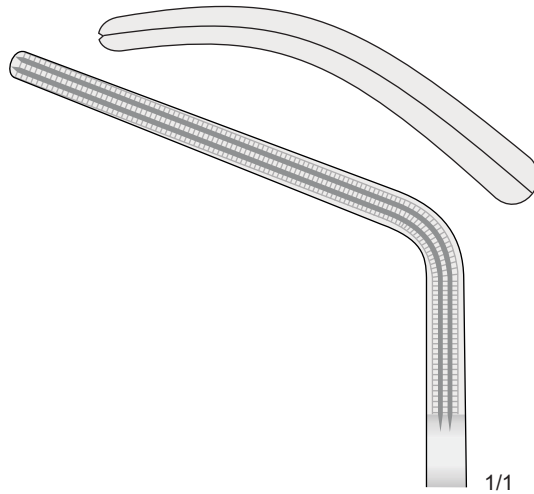

De BAKEY
FB-141
240 mm

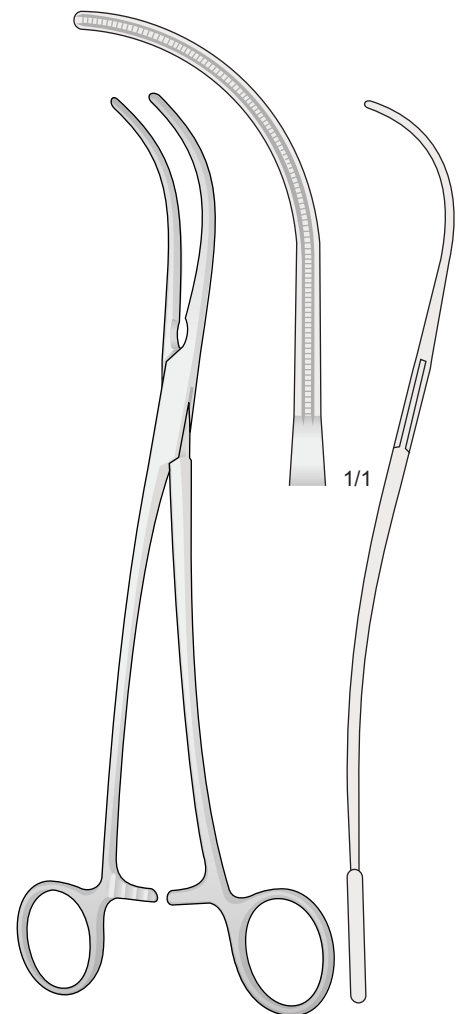

De BAKEY
FB-142
240 mm

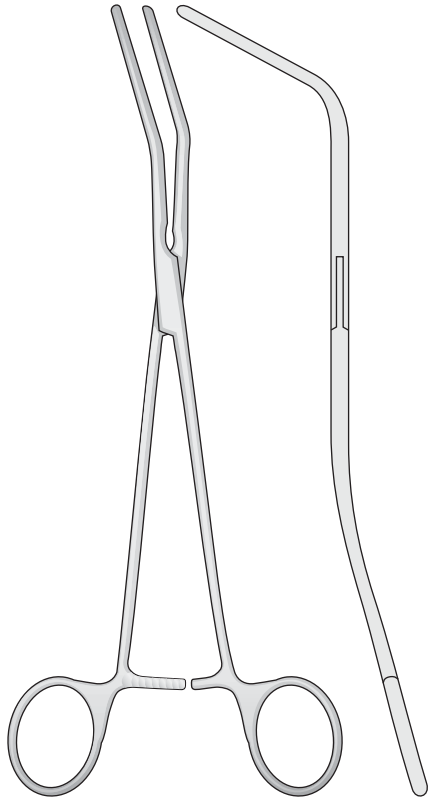

De BAKEY
FB-25/FB-28

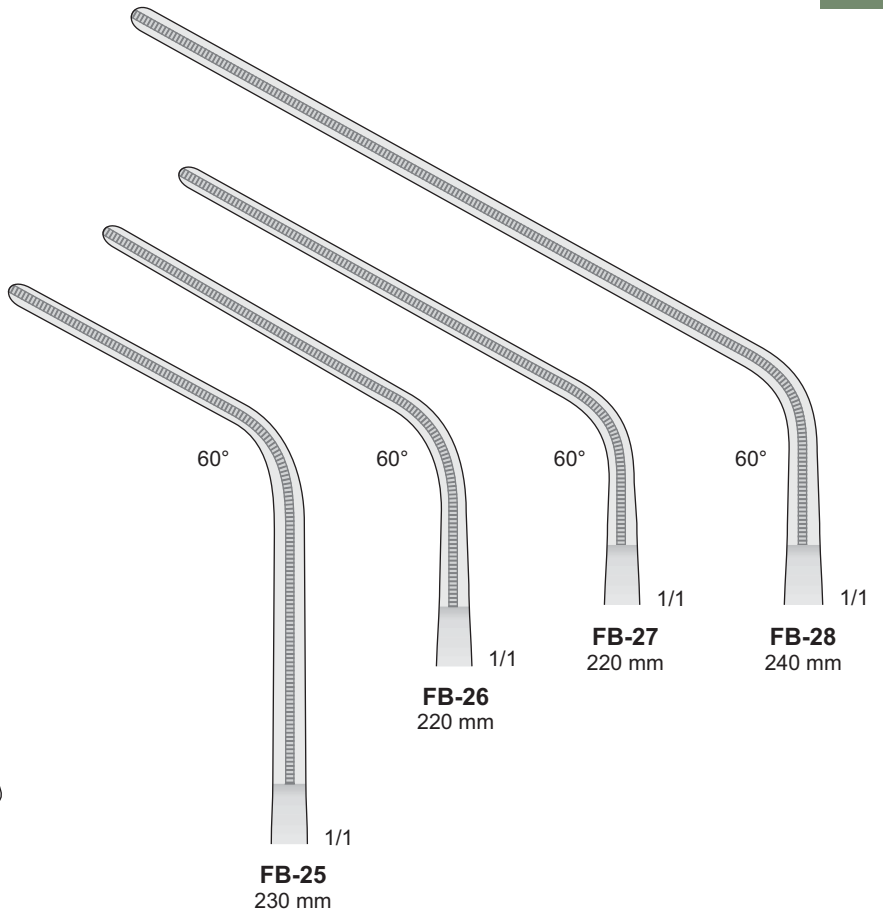

De-BAKEY
FB-180/FB-183

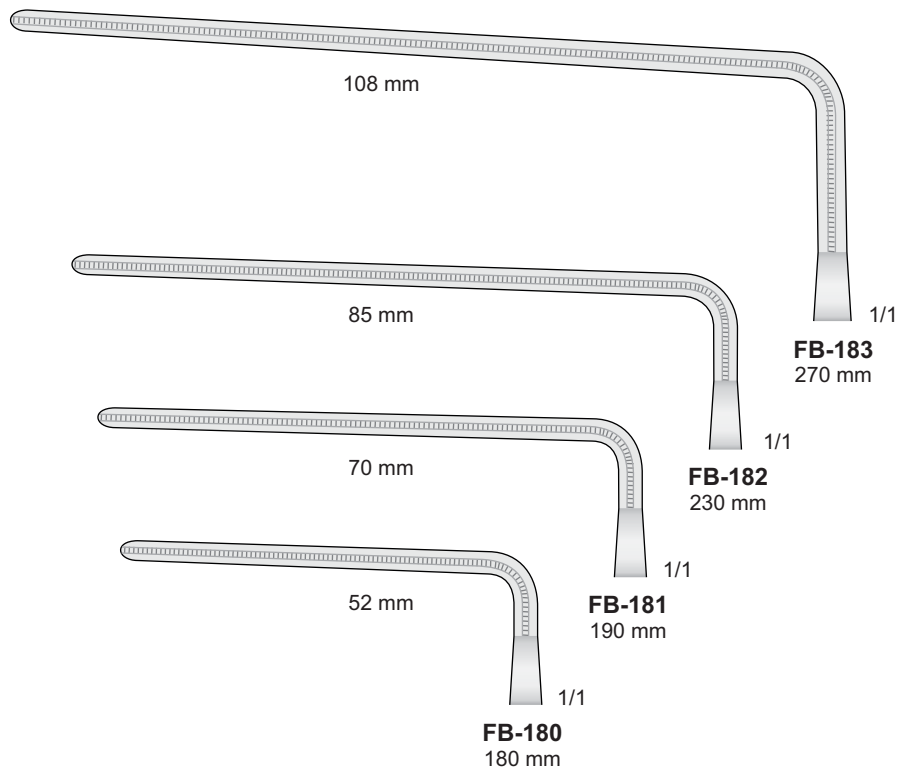

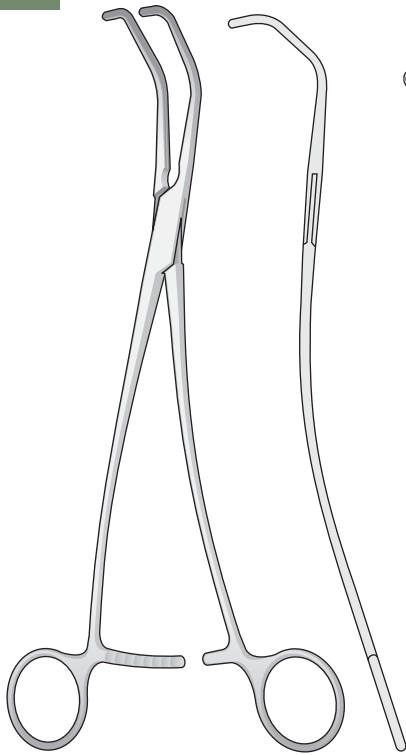

De BAKEY-SATINSKY
FB-265/FB-267

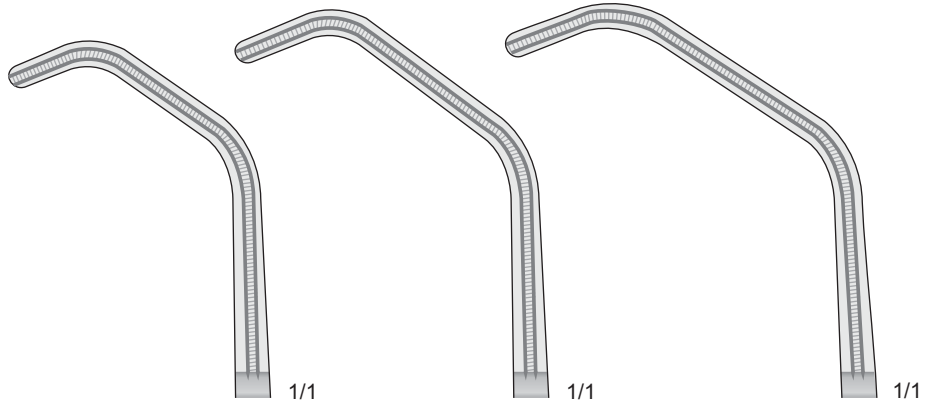

FB-265
235 mm

FB-266
240 mm

FB-267
250 mm

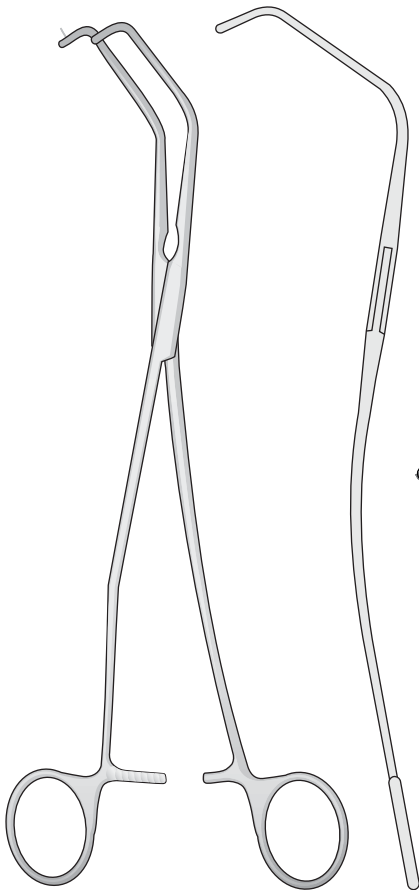

De-BAKEY
FB-147/FB-151

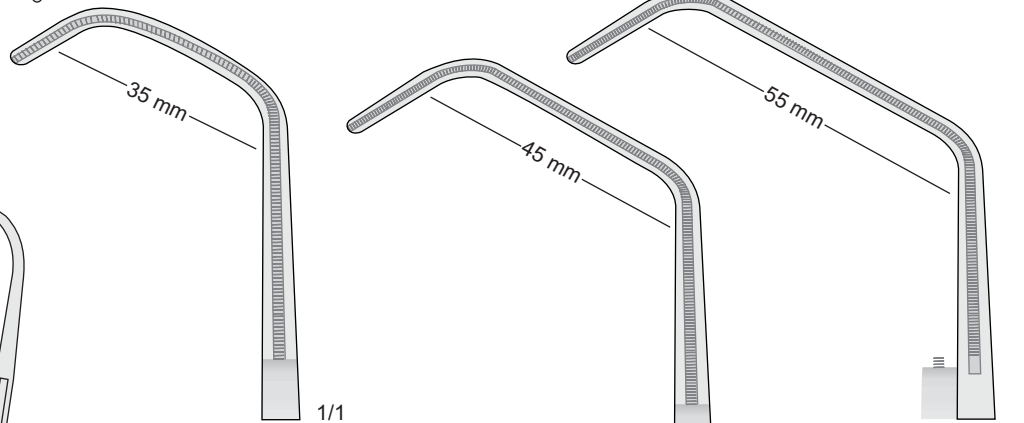

FB-147
200 mm

FB-148
240 mm

FB-149
250 mm

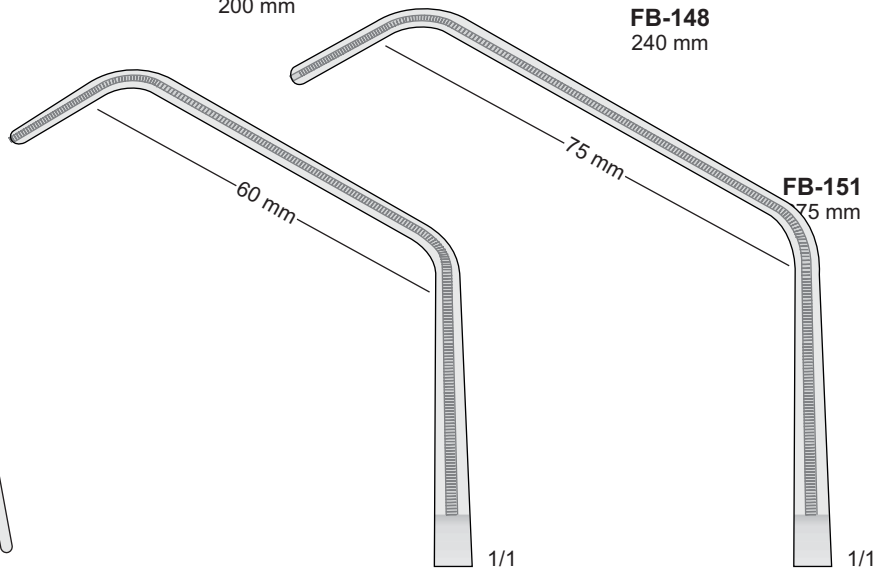

FB-150
265 mm

FB-151
75 mm

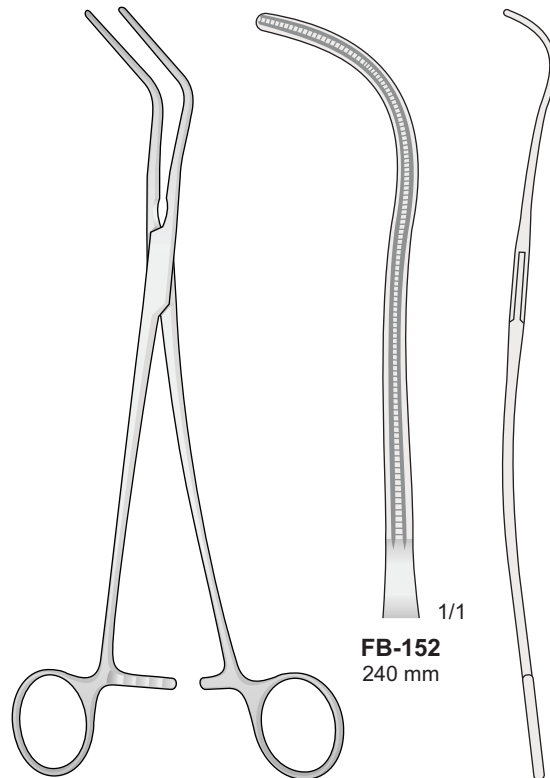
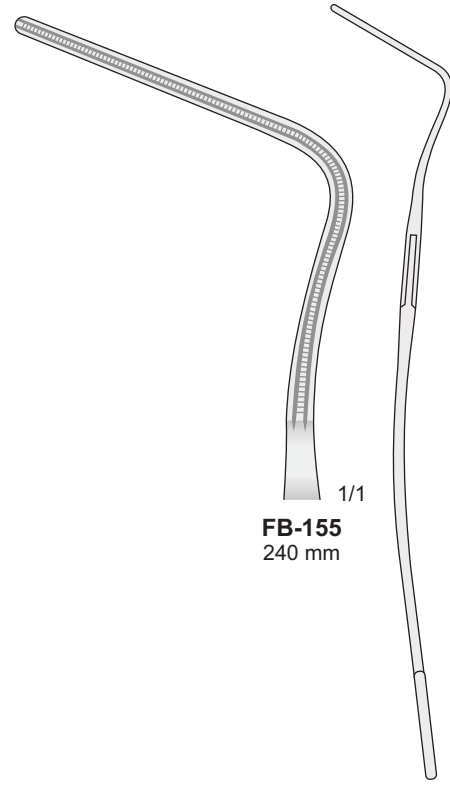
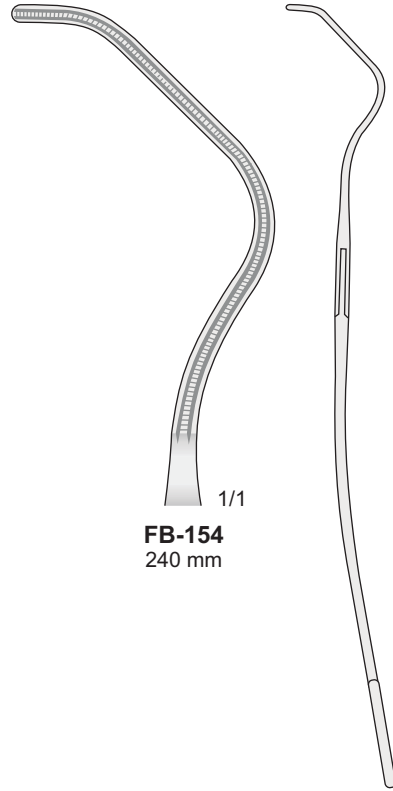
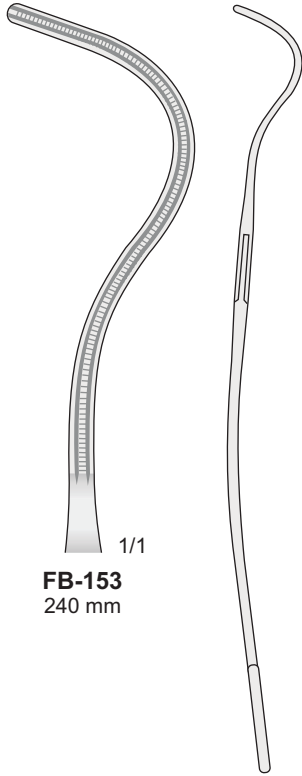

De BAKEY-HARKEN
FB-152/FB-155

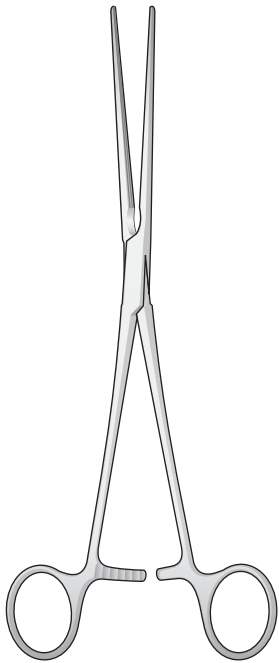

De BAKEY
FB-168/FB-171



1/1
FB-168
215 mm



1/1
FB-169
230 mm



1/1
FB-170
270 mm



1/1
FB-171
315 mm

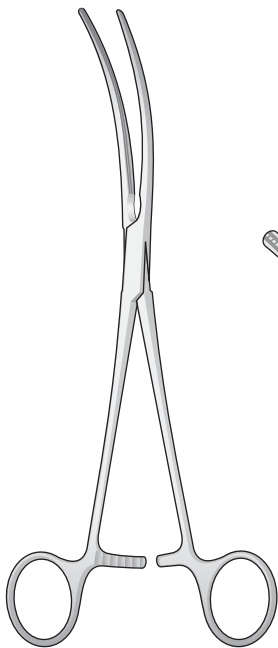

De BAKEY
FB-172/FB-175



1/1
FB-172
215 mm

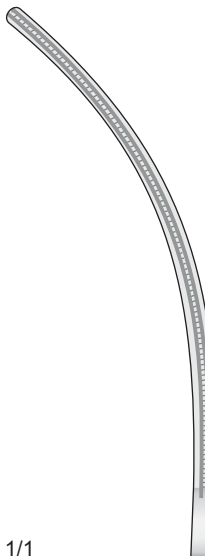

1/1
FB-173
230 mm

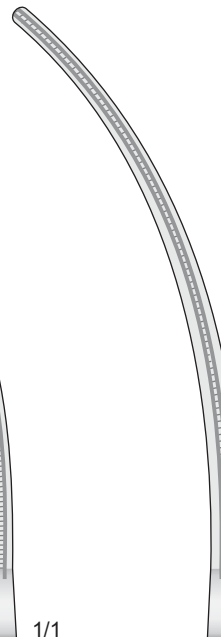

1/1
FB-174
270 mm

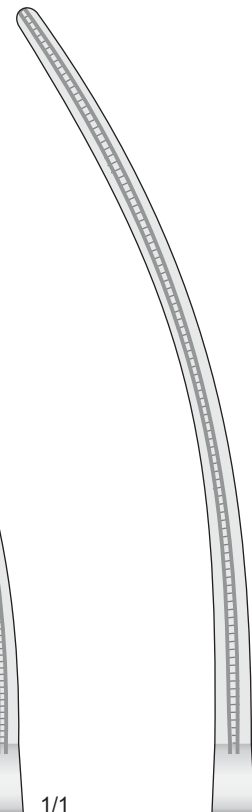

1/1
FB-175
310 mm

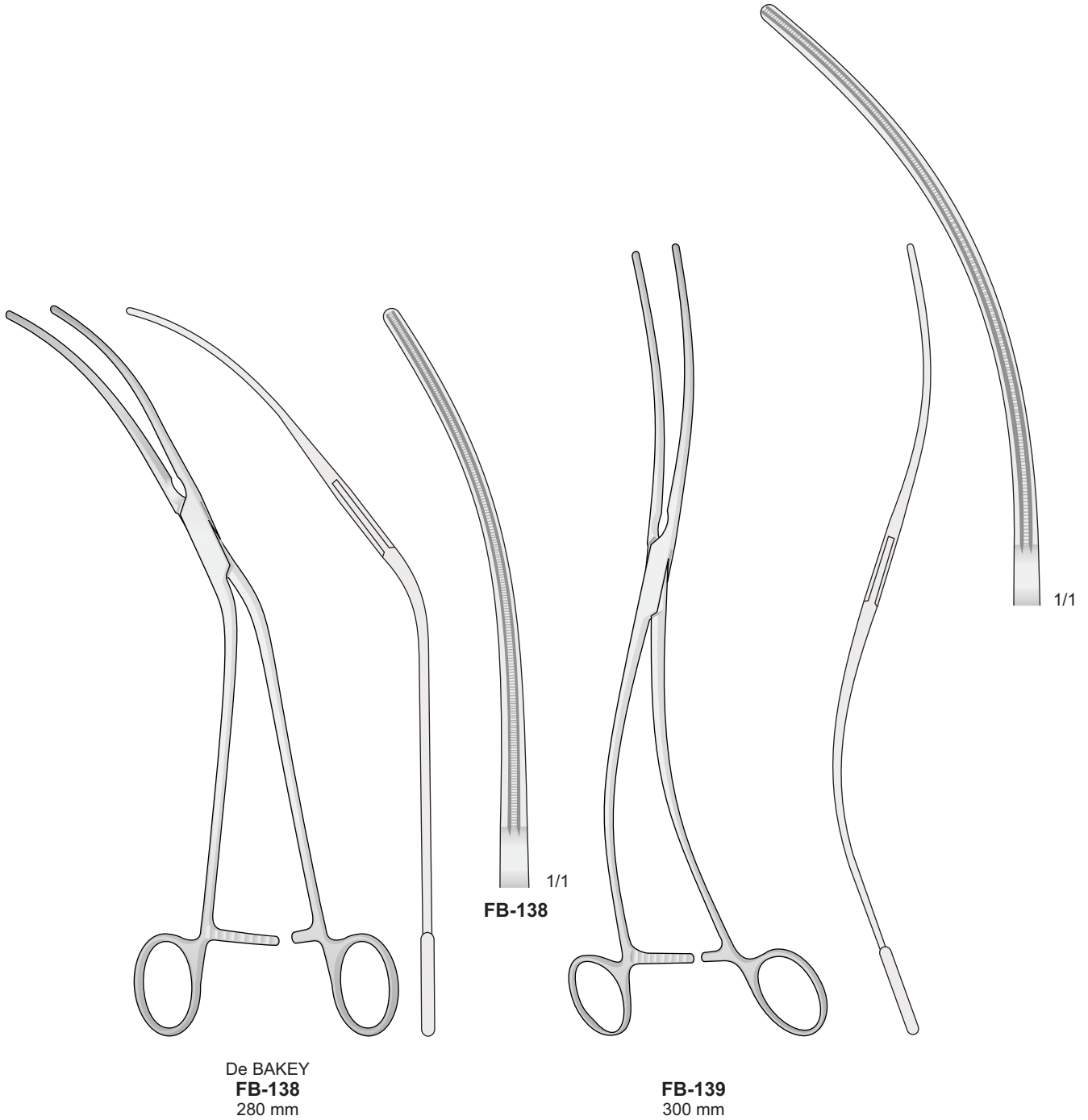

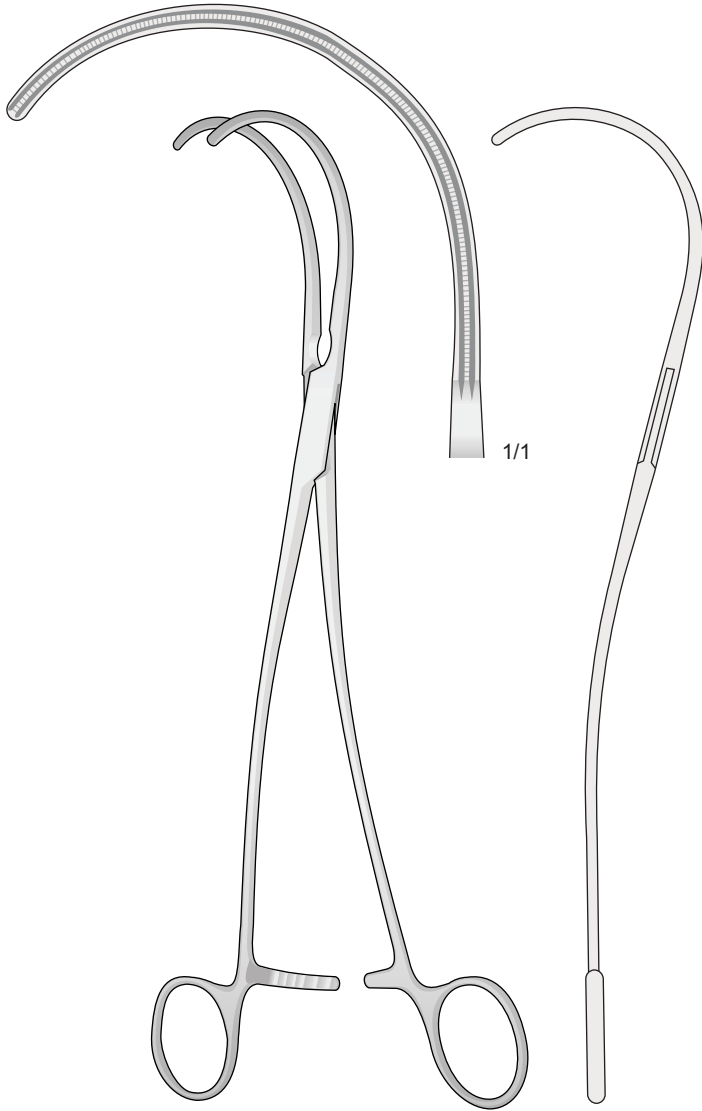

De BAKEY
FB-143
260 mm

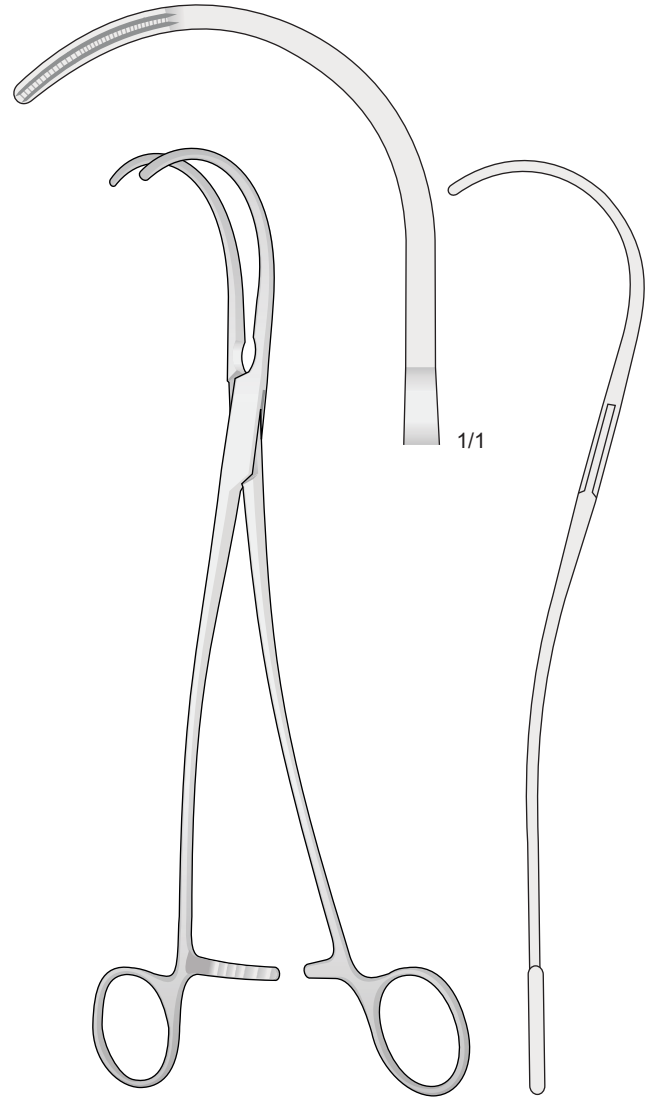

De BAKEY
FB-144
250 mm

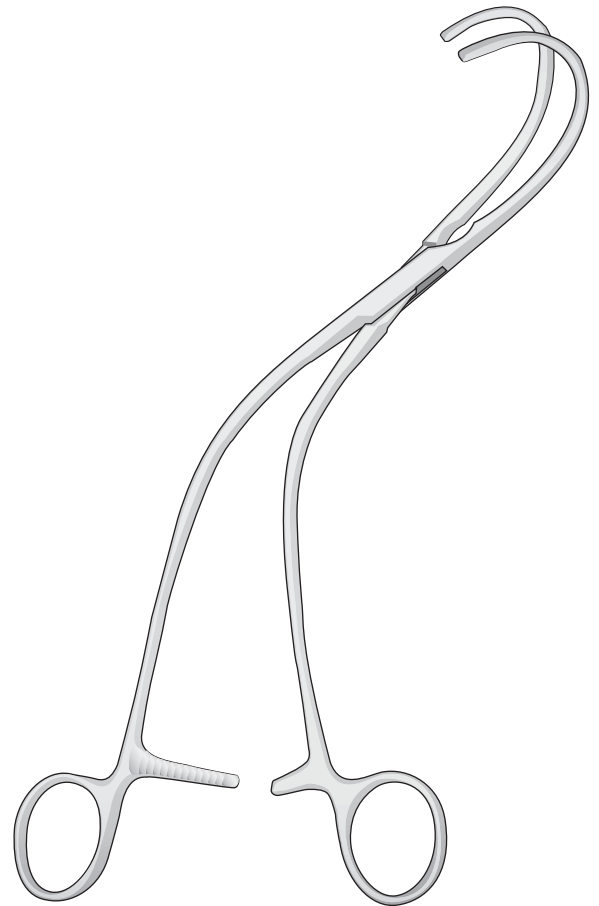
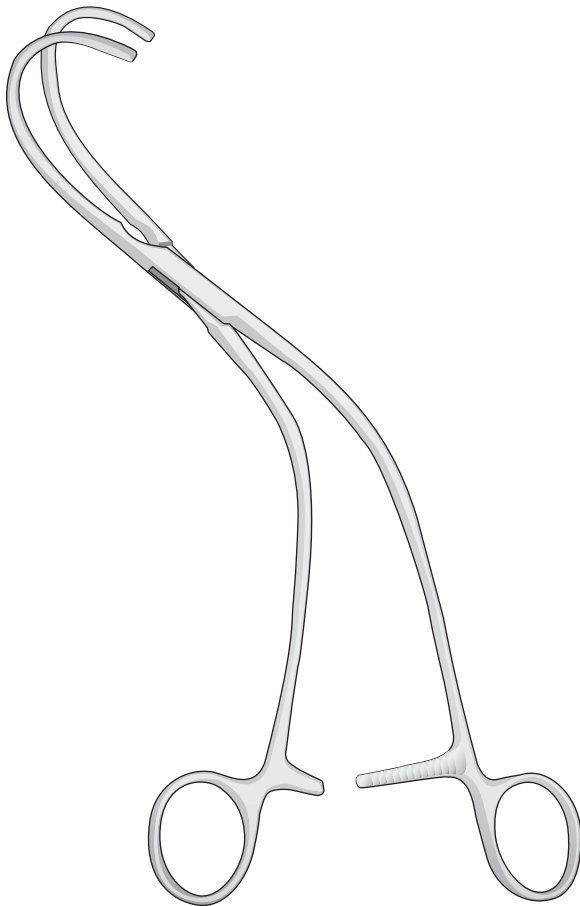
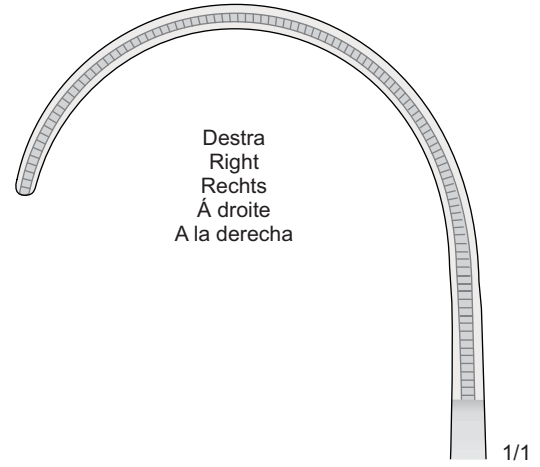
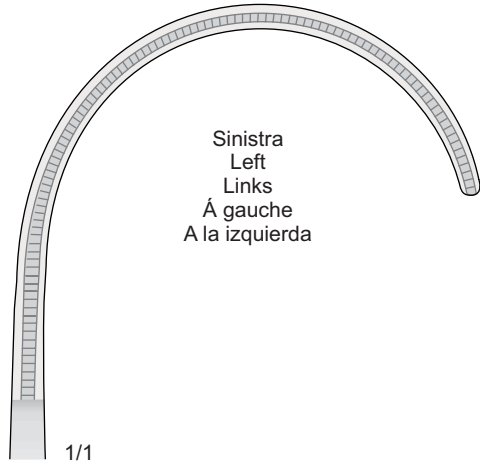

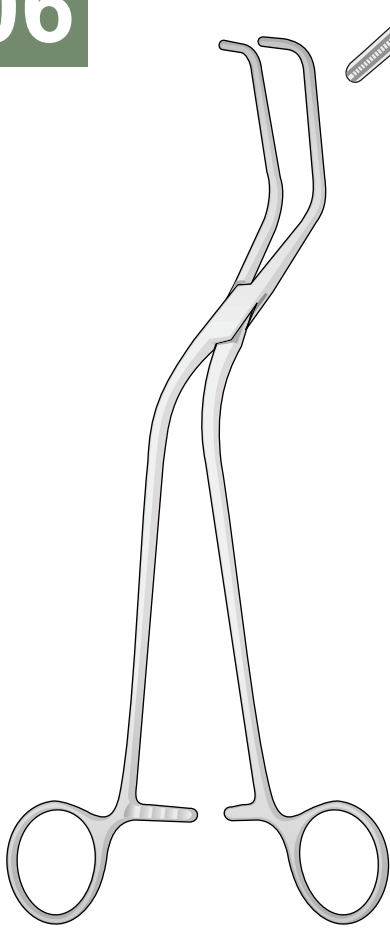

OCHSNER
FB-94
235 mm

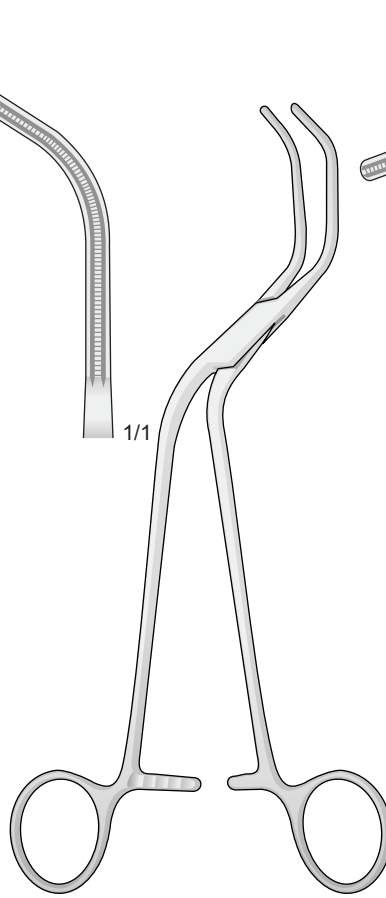

DIETRICH
FB-95
210 mm

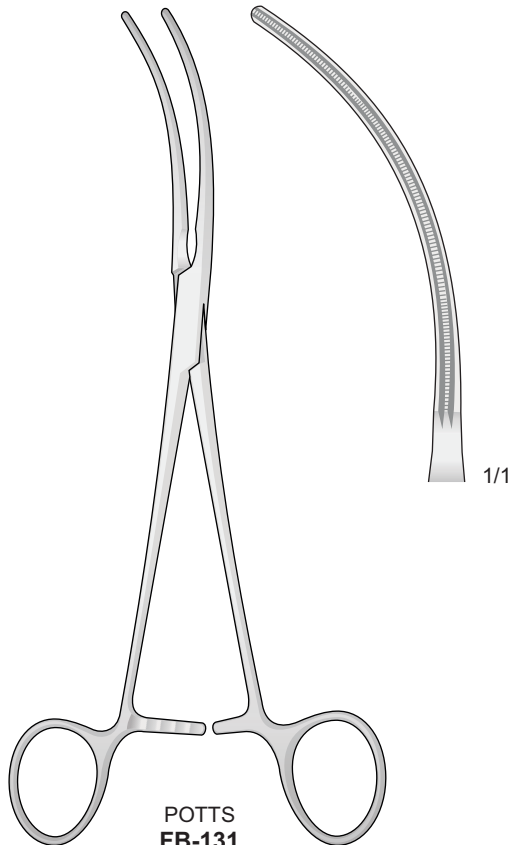

POTTS
FB-131
220 mm

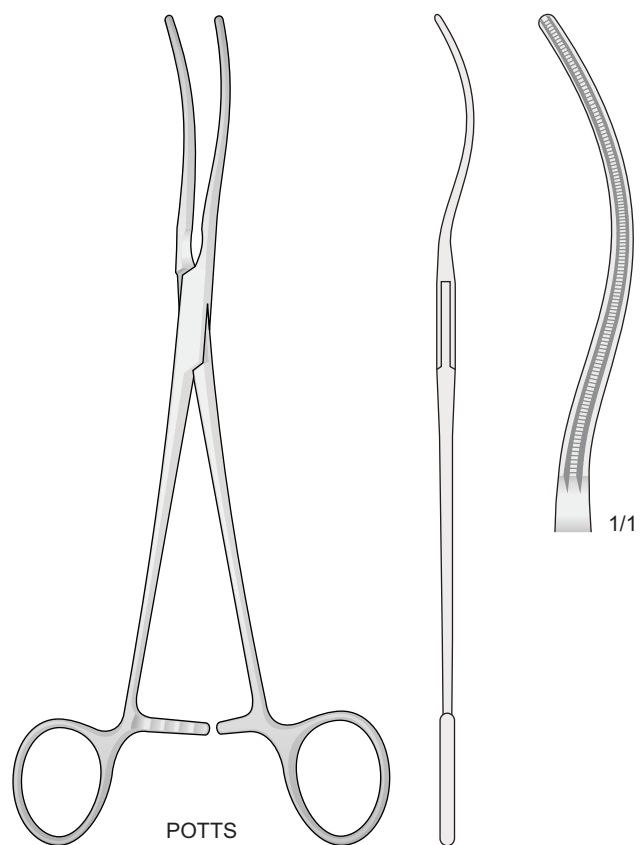

POTTS
FB-132
220 mm

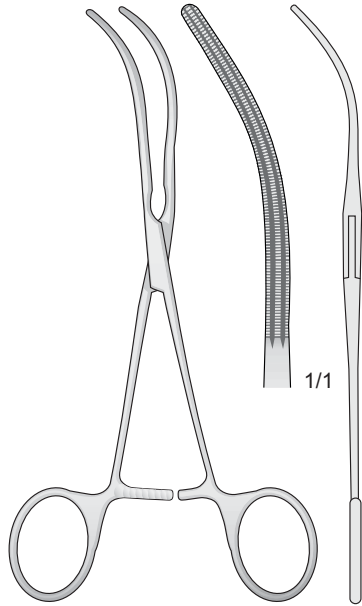

GLOVER
FB-184
170 mm

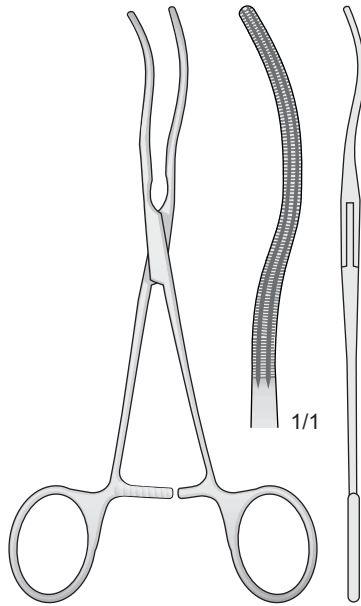

FB-185
170 mm

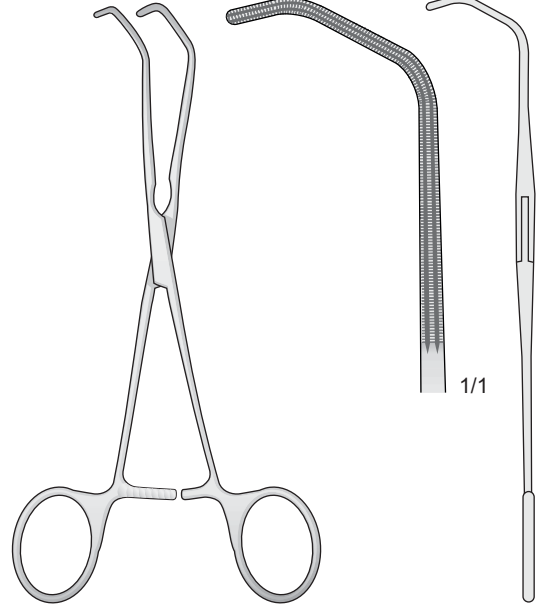

BECK
FB-186
170 mm

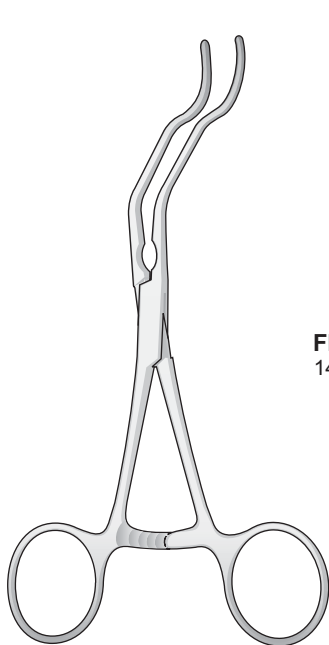

GREGORY
FB-110/FB-112

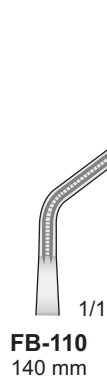

FB-110
140 mm



FB-111
160 mm



FB-112
180 mm

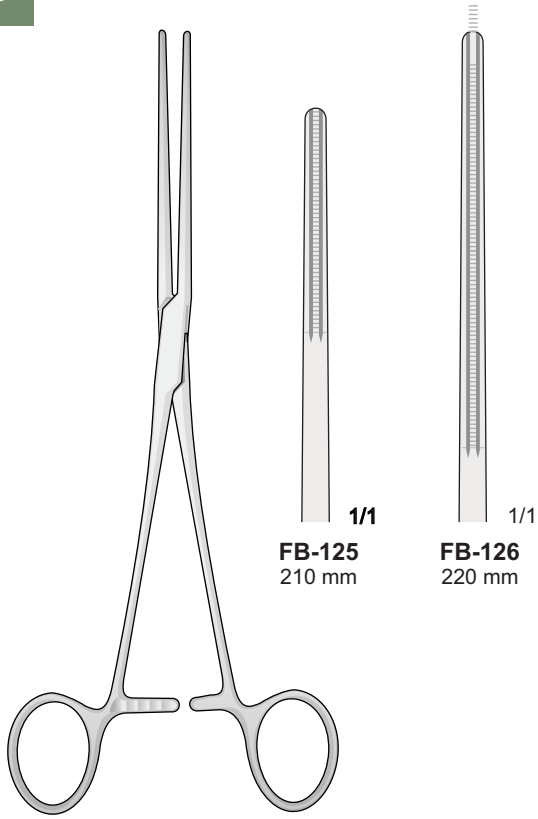

POTTS
FB-125/FB-126

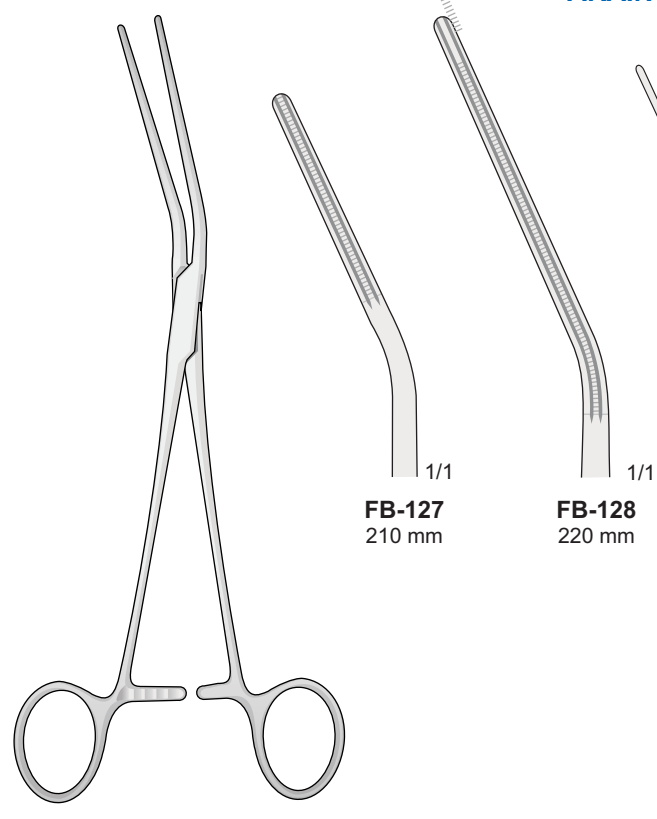

POTTS
FB-127/FB-128

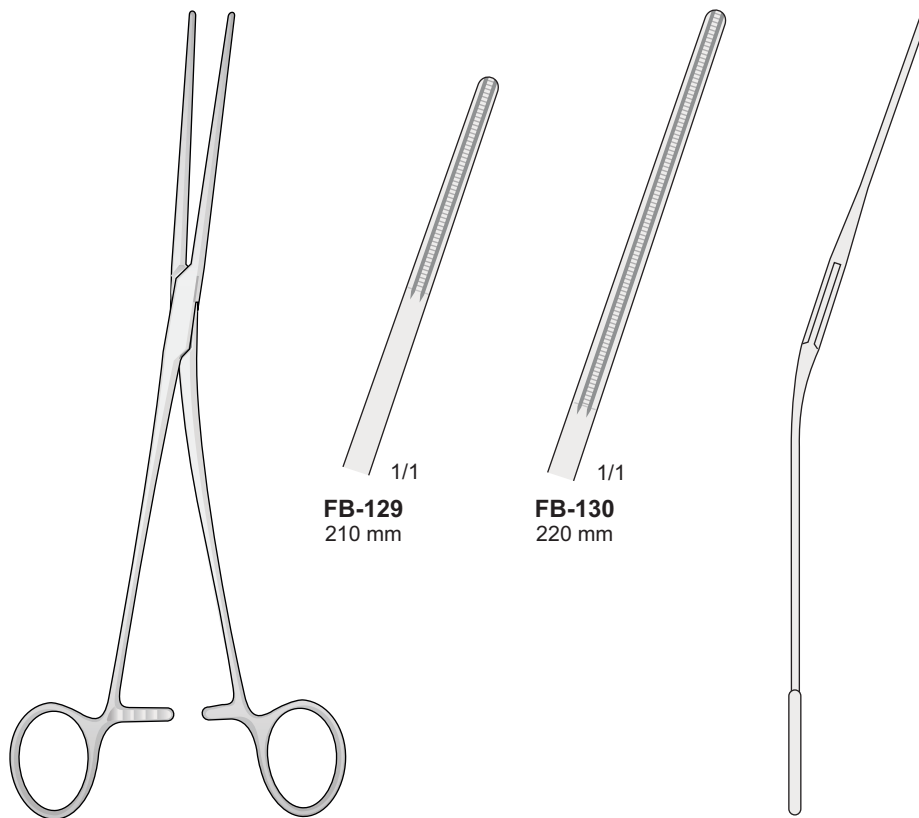

POTTS
FB-129/FB-130

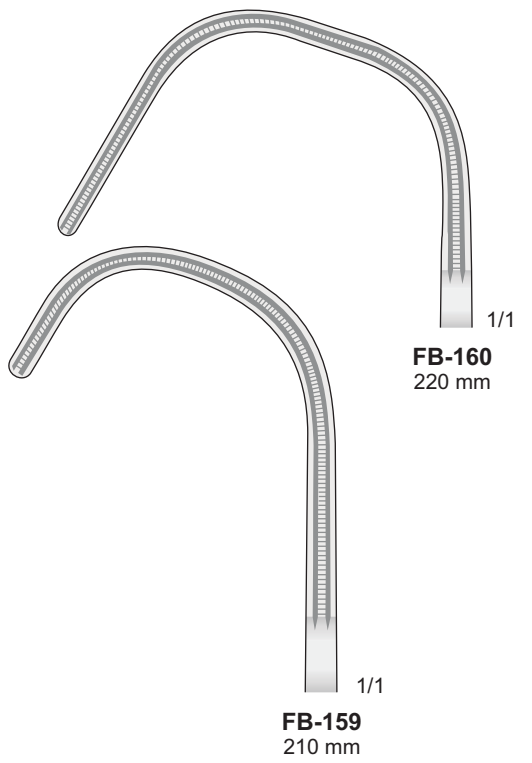
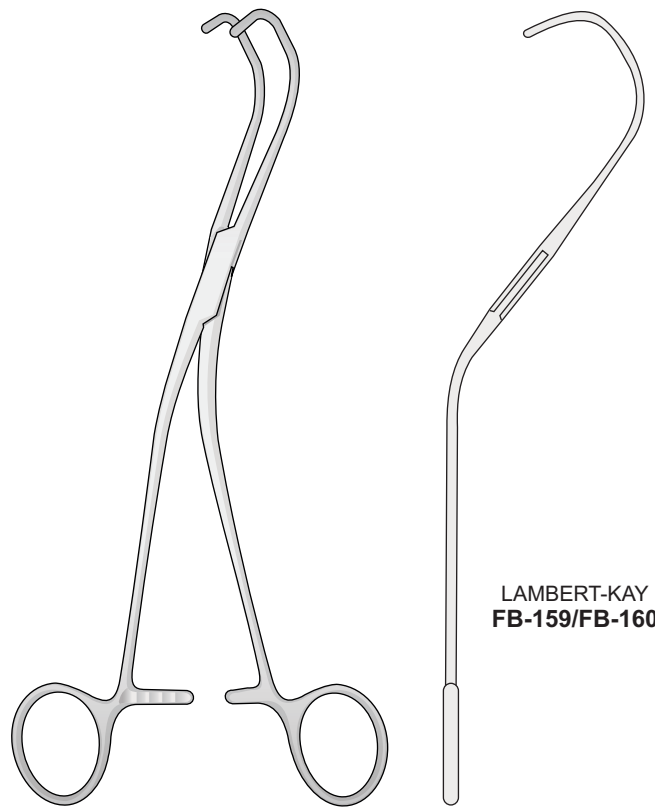
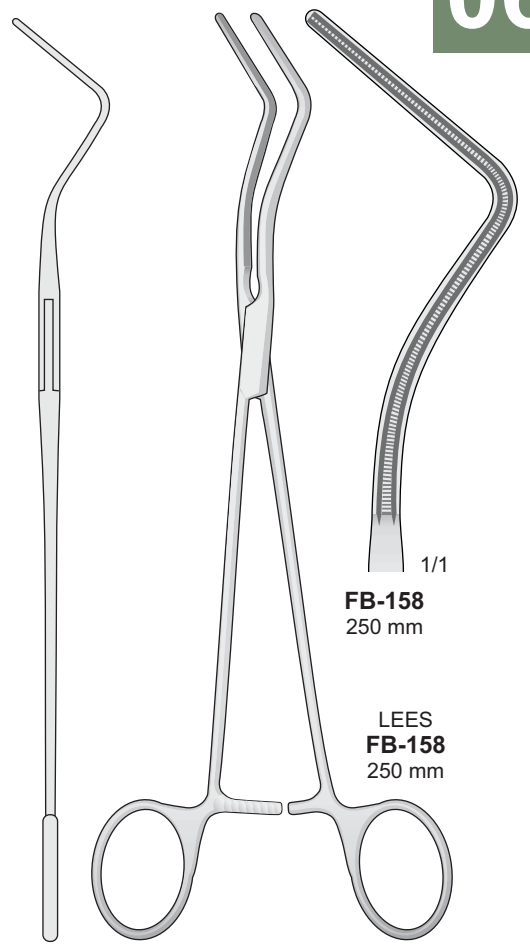

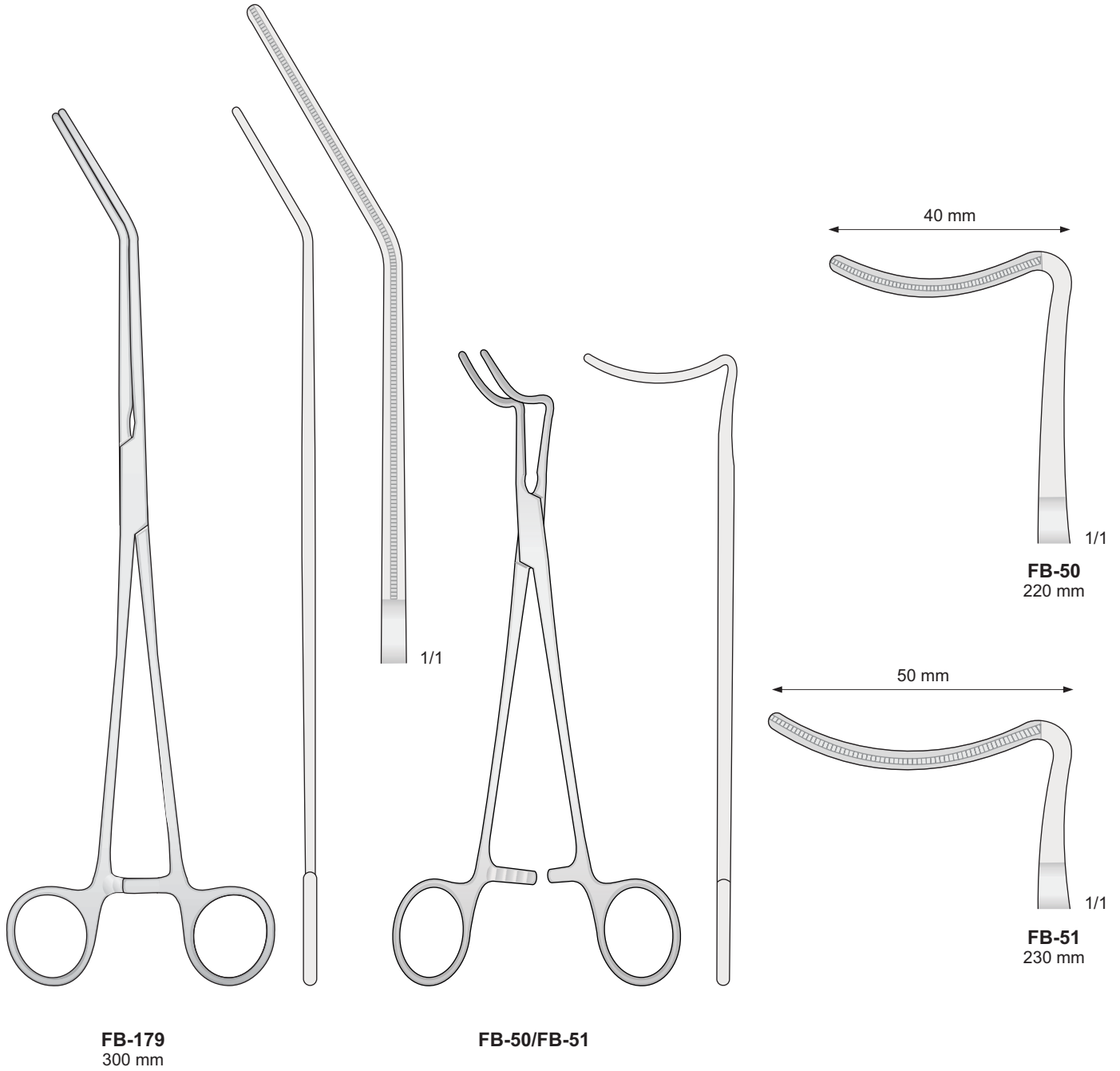

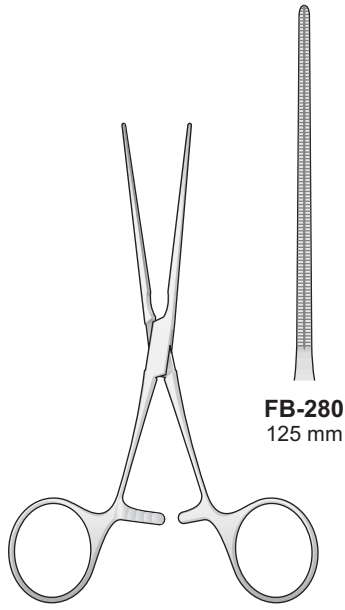

COOLEY
FB-280/FB-281

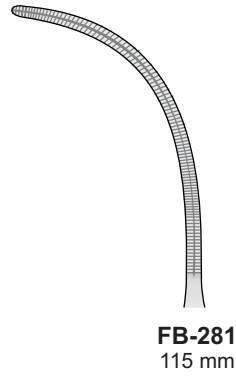

FB-281
115 mm

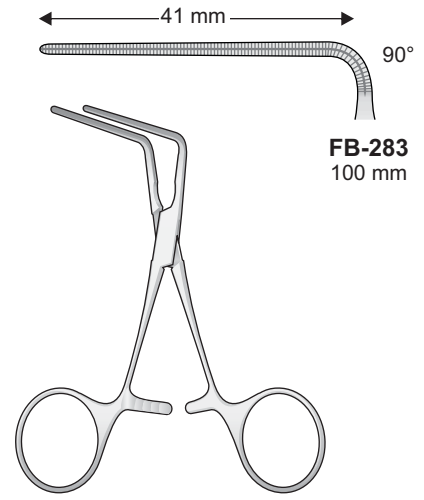

COOLEY
FB-283

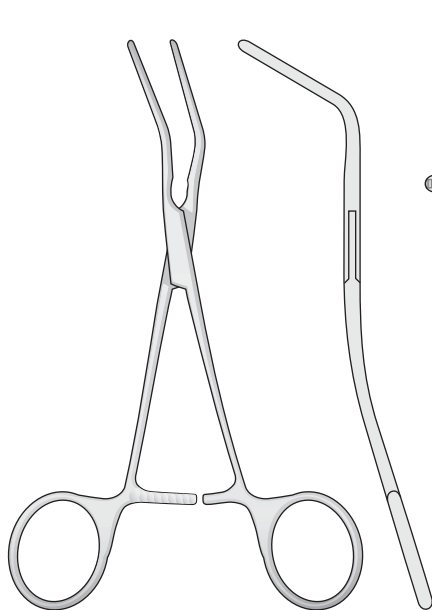

COOLEY
FB-11/FB-13

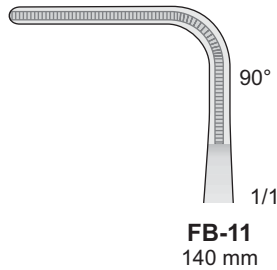

FB-11
140 mm

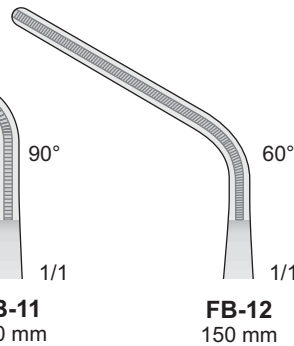

FB-12
150 mm

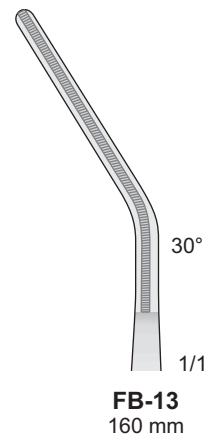

FB-13
160 mm

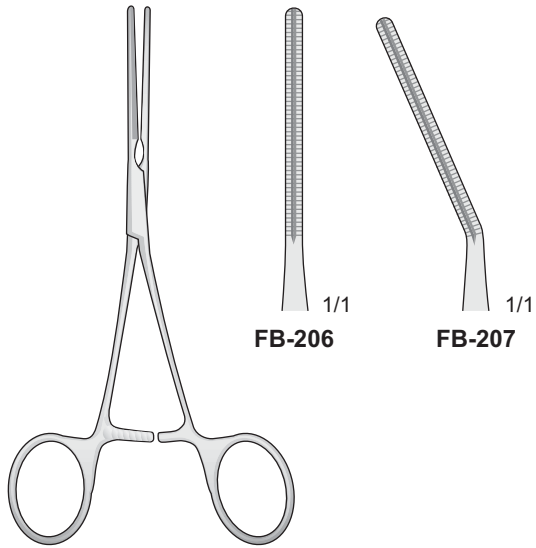

COOLEY
FB-206/FB-207
140 mm

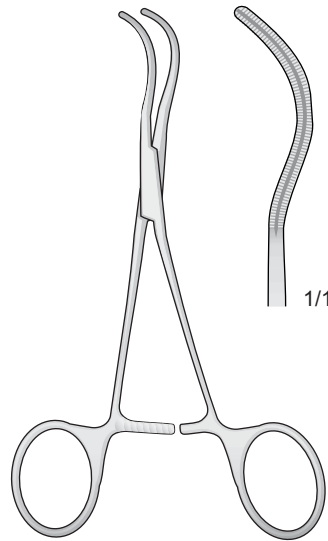

COOLEY
FB-210
140 mm

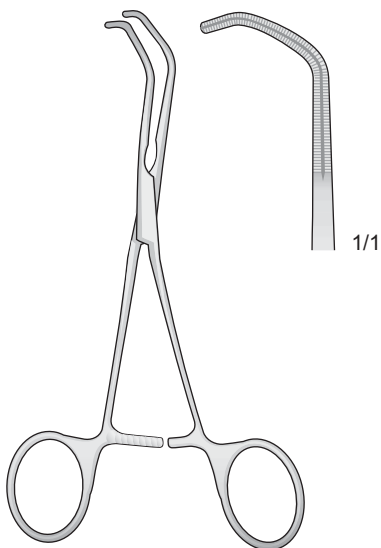

COOLEY
FB-209
140 mm

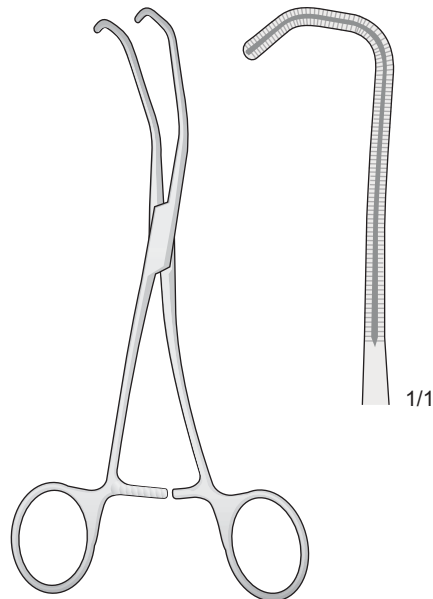

COOLEY
FB-190
160 mm

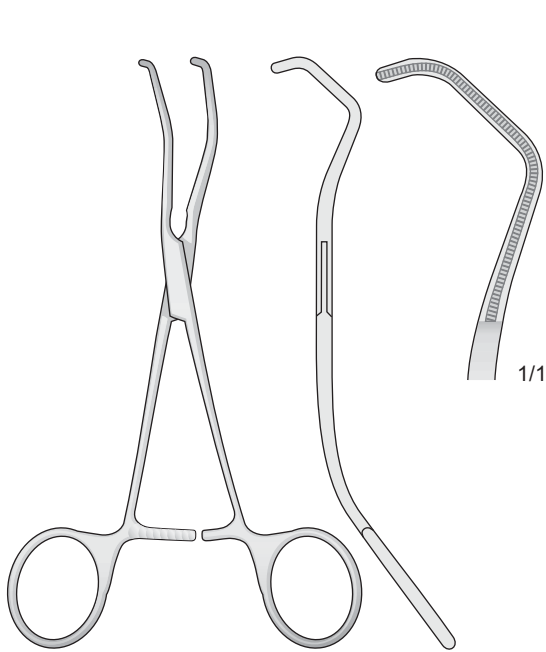

COOLEY
FB-16
160 mm

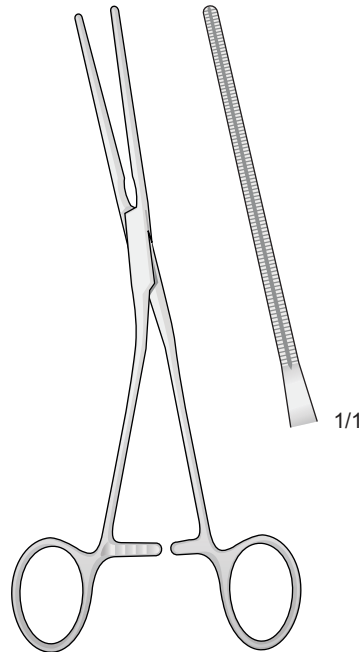

COOLEY
FB-195
170 mm

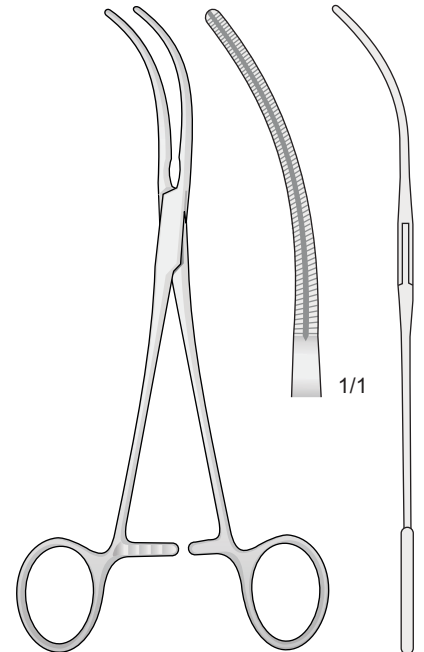

COOLEY
FB-196
170 mm

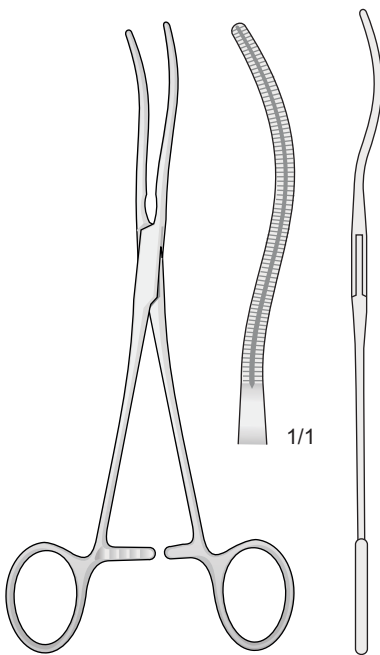

COOLEY
FB-197
170 mm

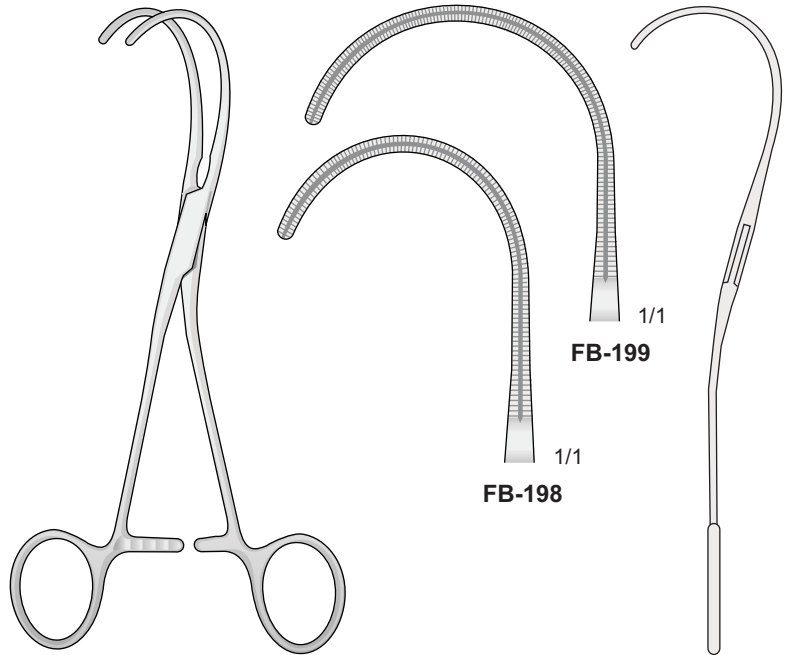

COOLEY
FB-198/FB-199
170 mm

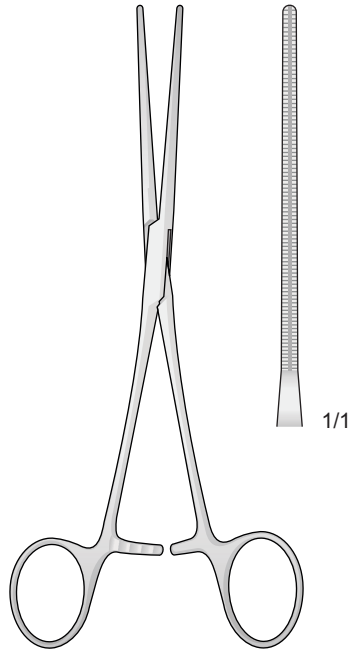

COOLEY
FB-188
170 mm

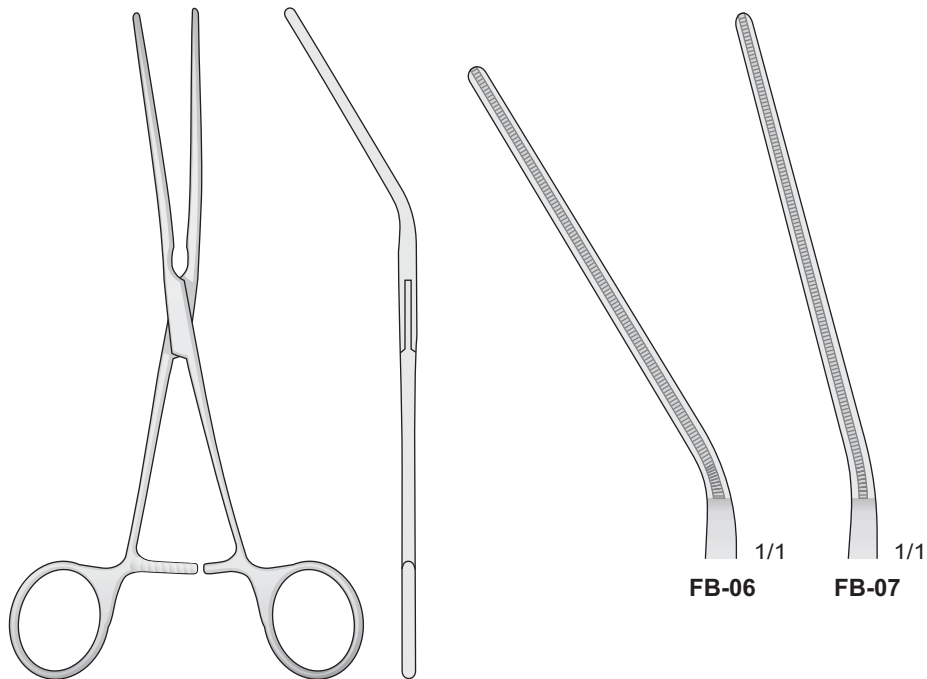

LELAND - JONES
FB-06/FB-07
190 mm

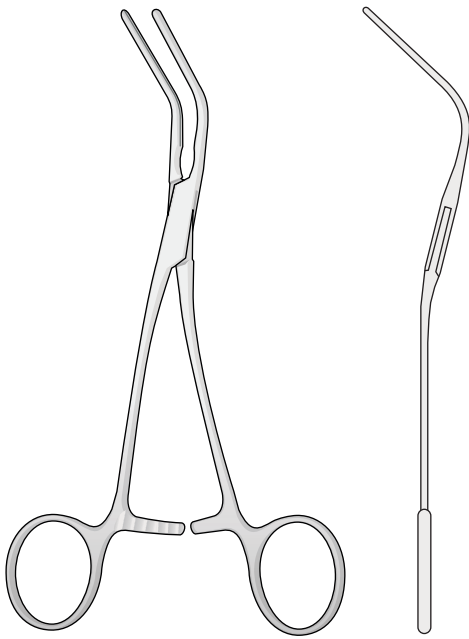

COOLEY
FB-192/FB-194

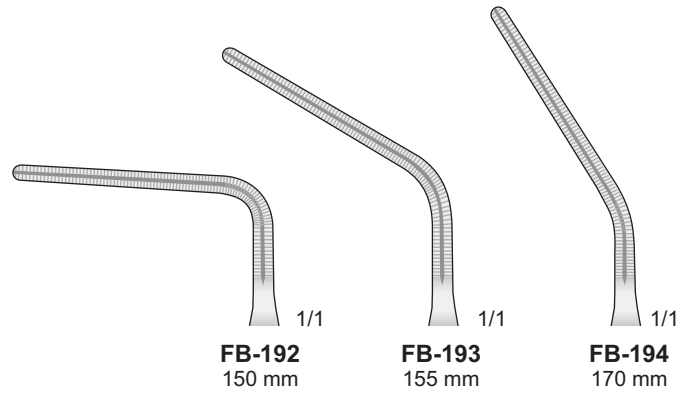

FB-192
150 mm

FB-193
155 mm

FB-194
170 mm

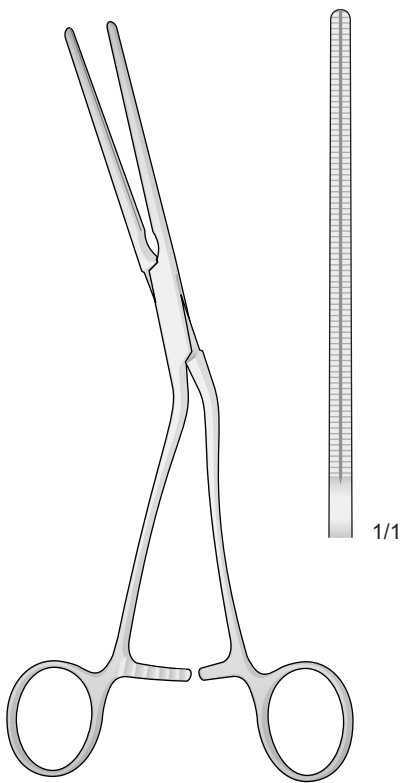

COOLEY
FB-187
210 mm

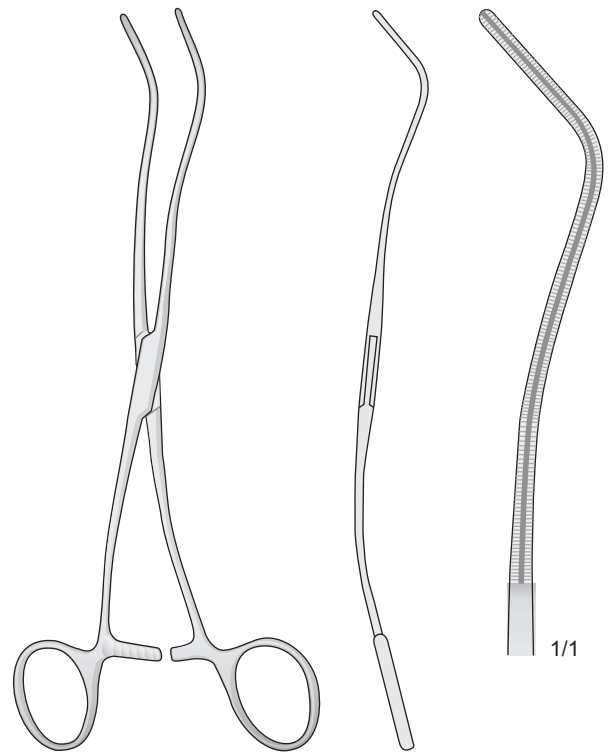

COOLEY
FB-189
200 mm

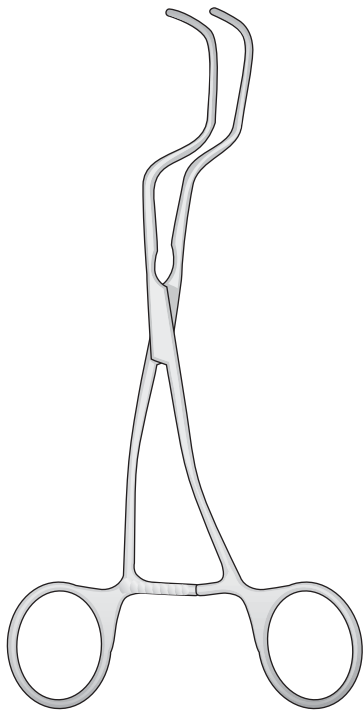

DALE
FB-96
185 mm

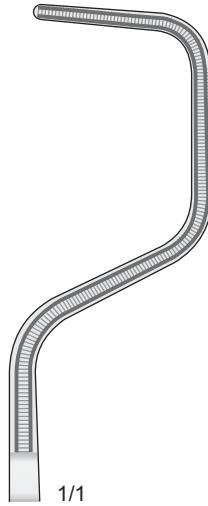

FB-96
185 mm

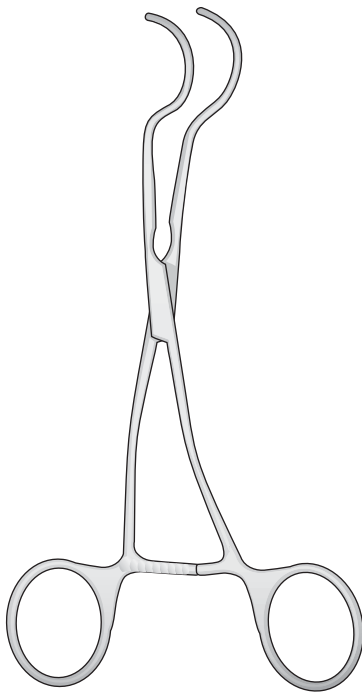

DALE
FB-97/FB-99

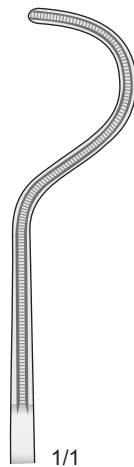

FB-97
170 mm

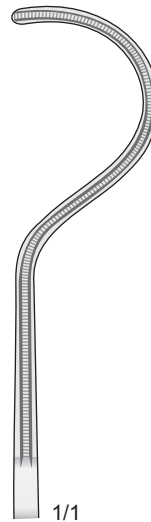

FB-98
175 mm

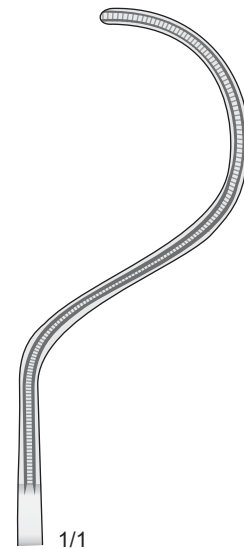

FB-99
185 mm

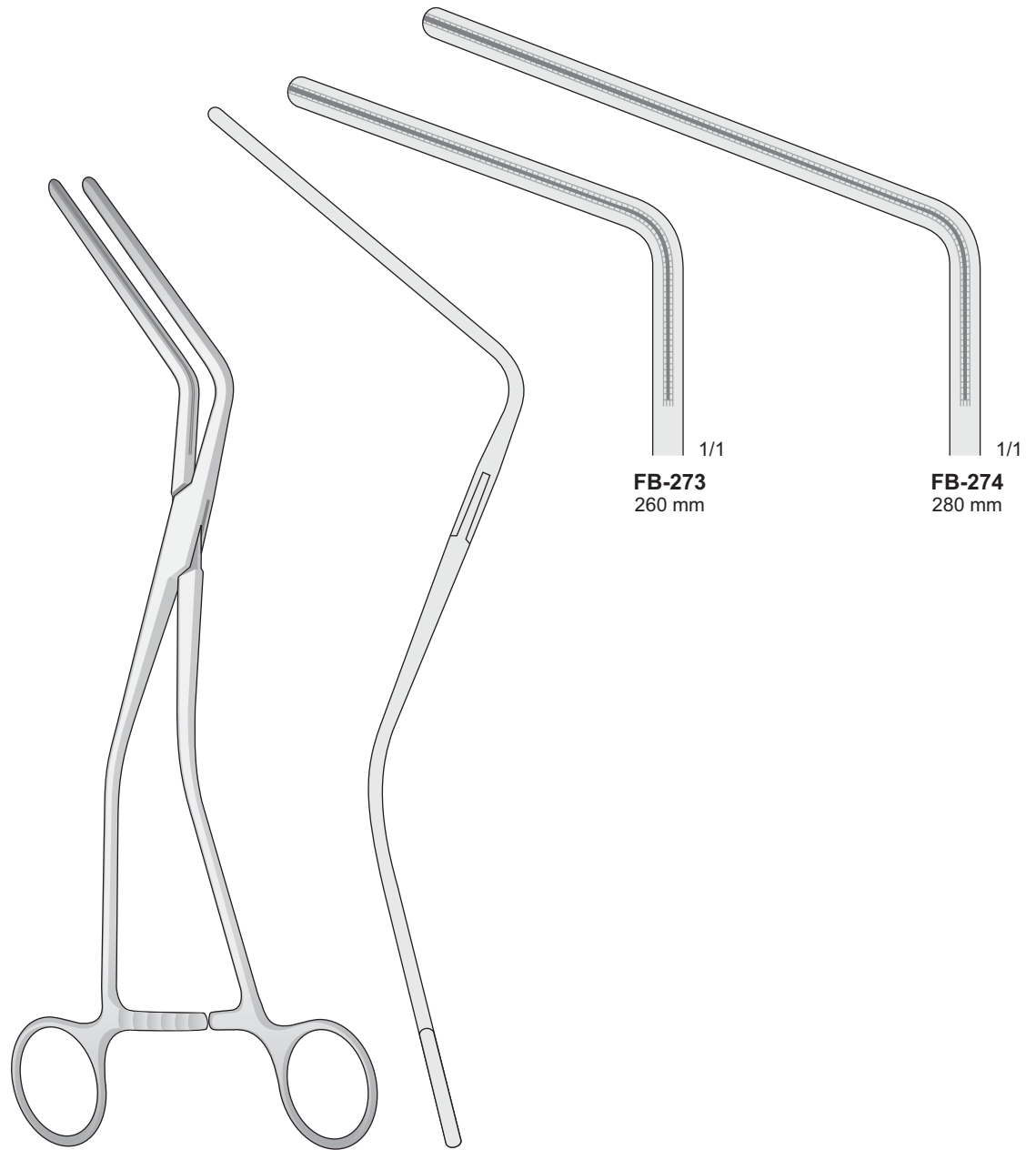

HAYES
FB-273/FB-274

FB-273
260 mm

FB-274
280 mm

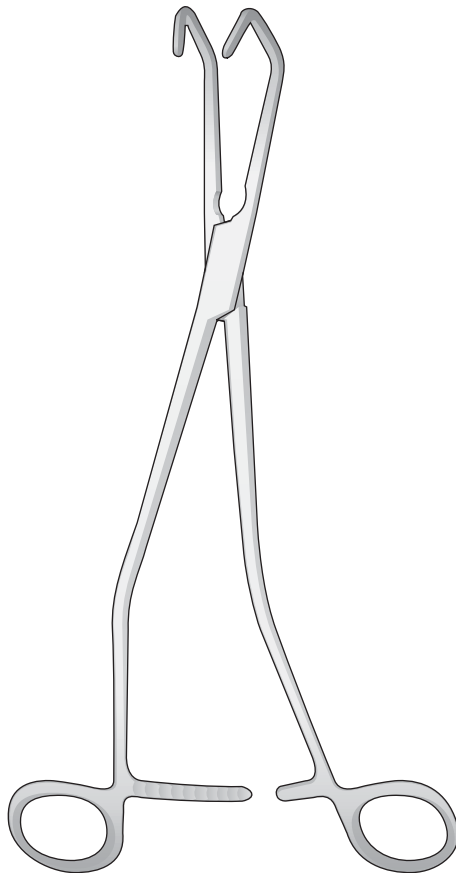
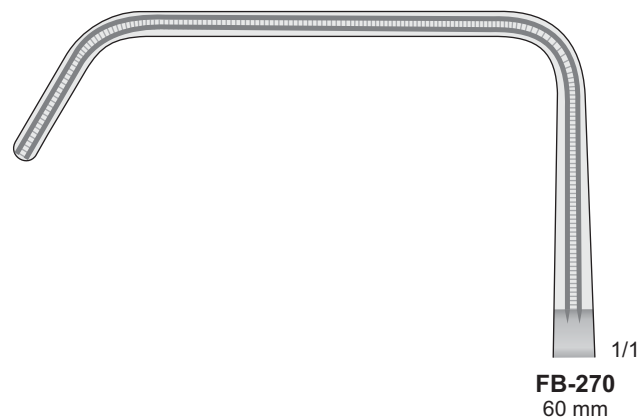
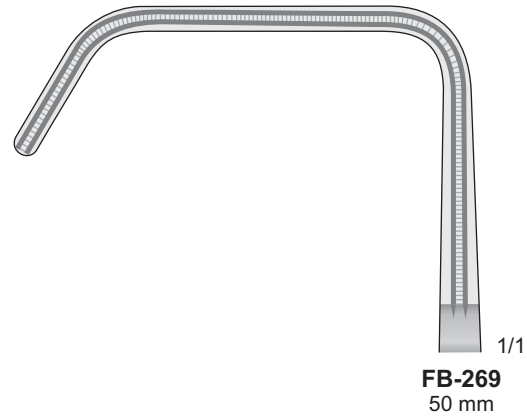
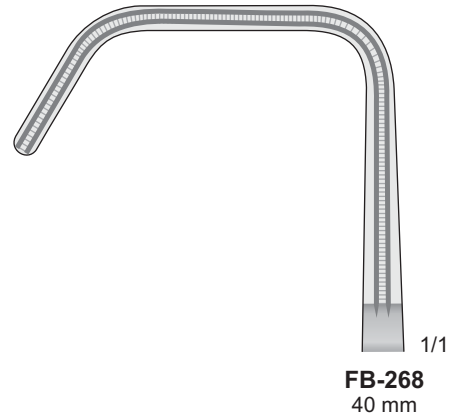

HOPT
FB-268 - 230 mm
FB-269 - 235 mm
FB-270 - 240 mm

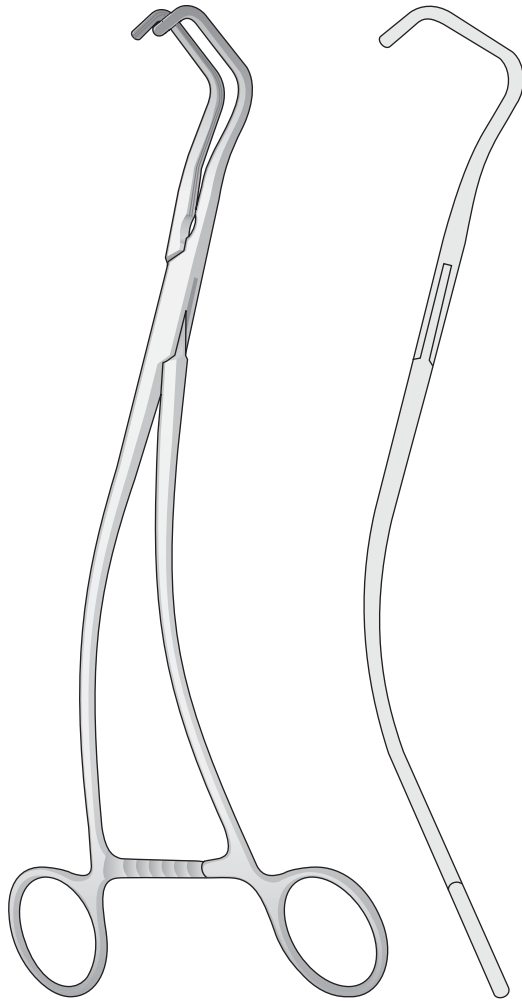

URO-TANGENTIAL
FB-271/FB-272
260 mm

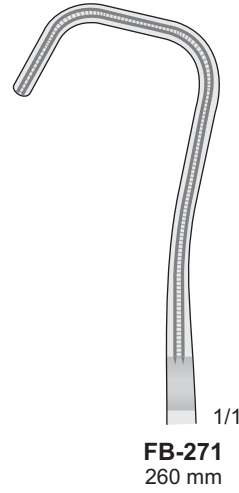

FB-271
260 mm

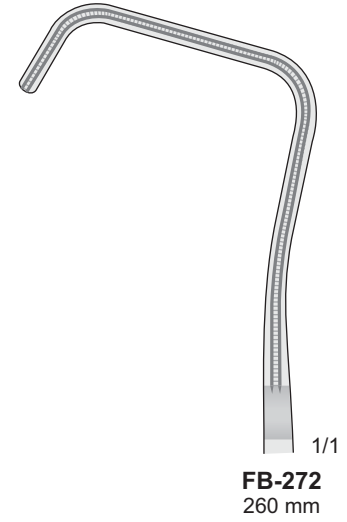

FB-272
260 mm

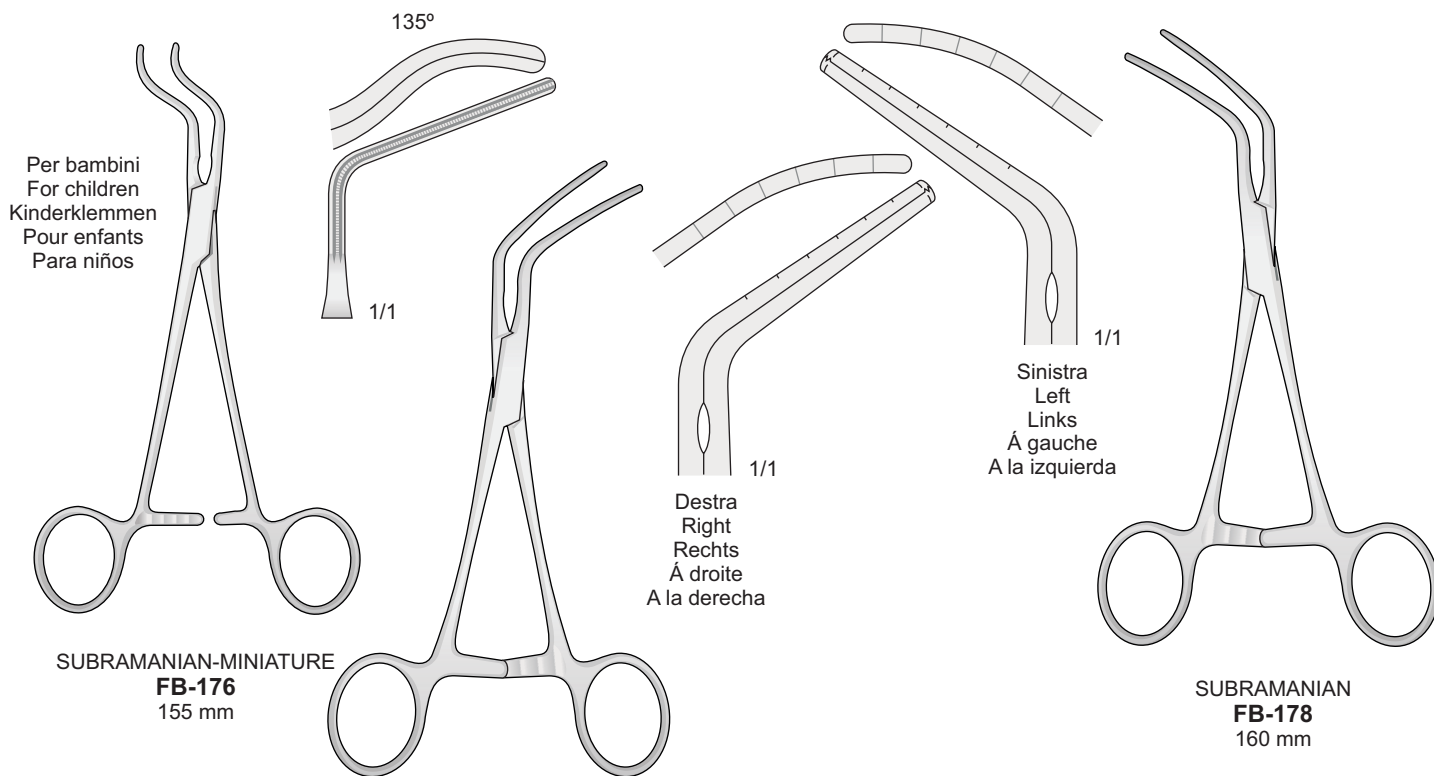

Per bambini
For children
Kinderklemmen
Pour enfants
Para niños

SUBRAMANIAN-MINIATURE
FB-176
155 mm

SUBRAMANIAN
FB-177
160 mm

SUBRAMANIAN
FB-178
160 mm

Destra
Right
Rechts
À droite
A la derecha

Sinistra
Left
Links
À gauche
A la izquierda

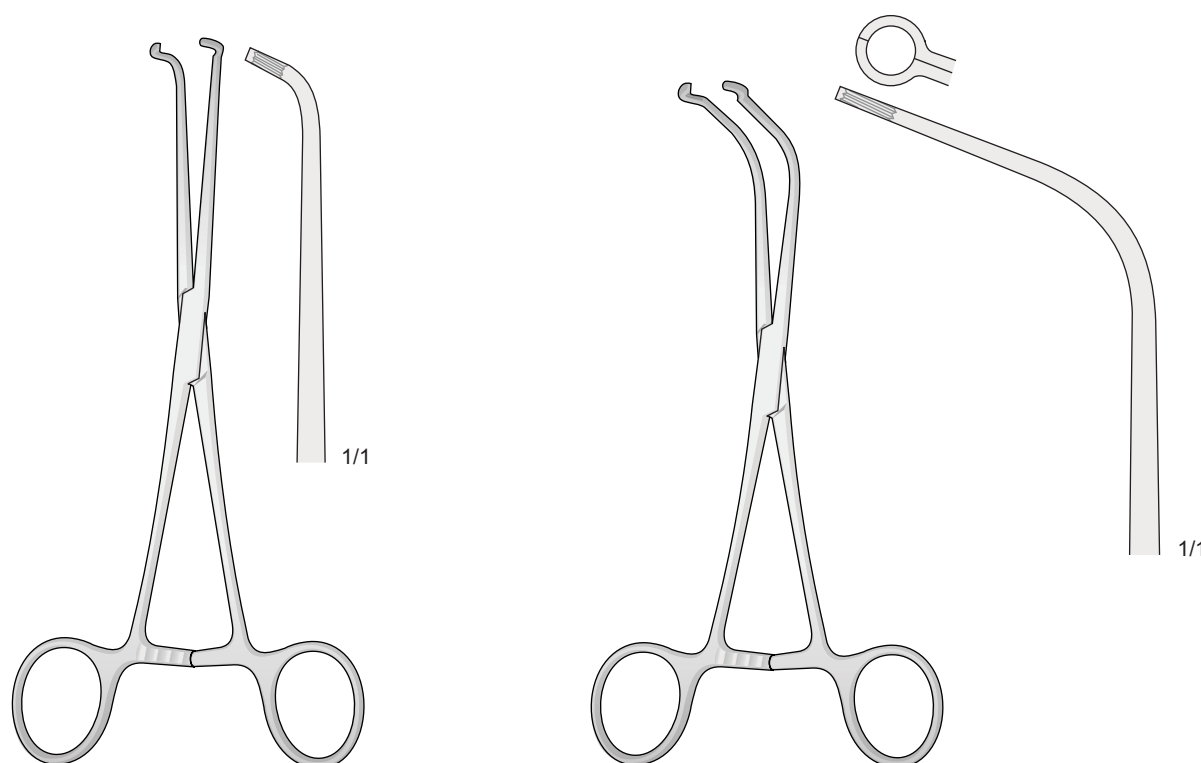

JAVID
FB-113
180 mm

JAVID
FB-114
190 mm



Atraumatiche - Atraumatic - Atraumatische
Atraumatique - Atraumáticas

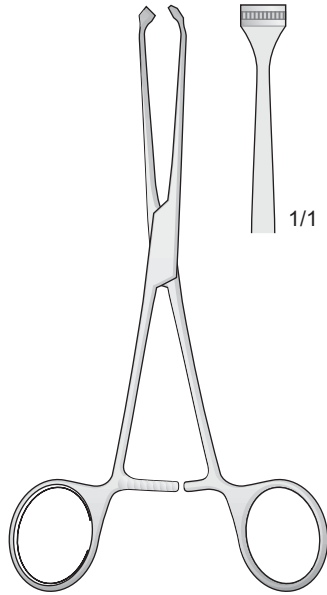

ALLIS
P-52
150 mm

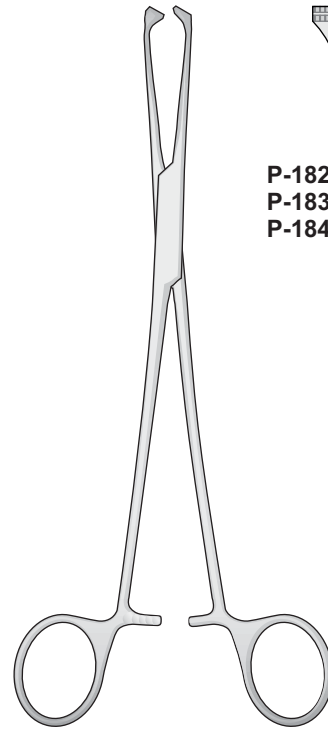

1/1
P-182 - 190 mm
P-183 - 250 mm
P-184 - 300 mm

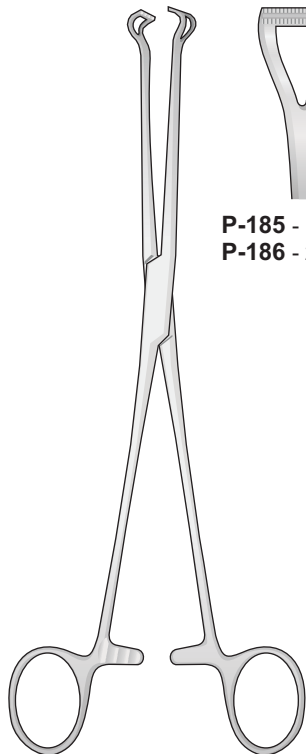

BABCOCK
P-185/P-186

P-185 - 160 mm
P-186 - 200 mm

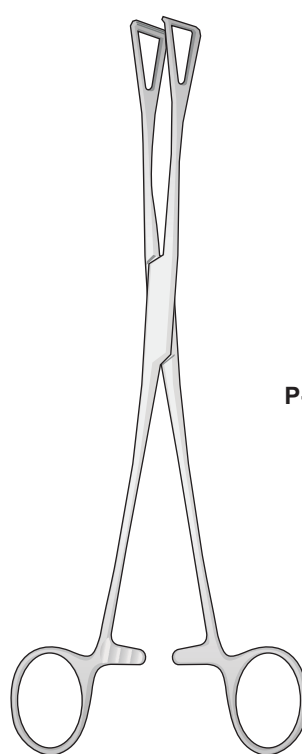

DUVAL
P-187/P-188

14 mm
P-187 - 200 mm

18 mm
P-188 - 200 mm

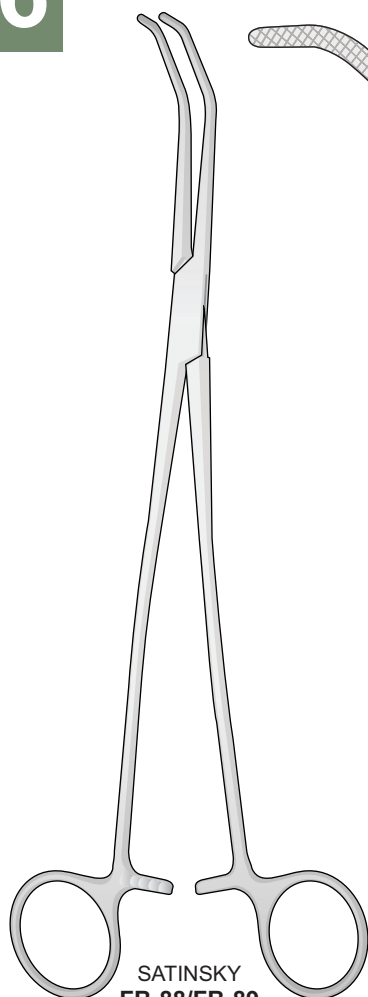

SATINSKY
FB-88/FB-89
260 mm

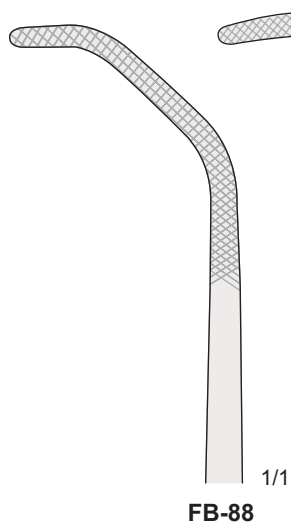

FB-88

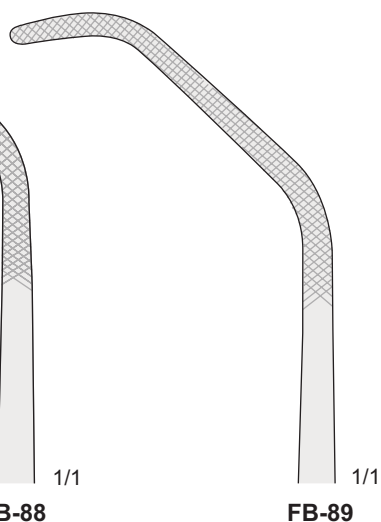

FB-89

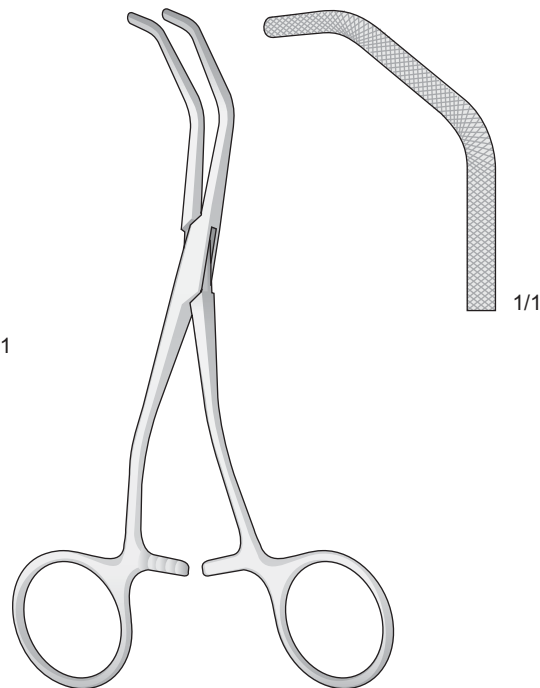

BABY-SATINSKY
FB-46
150 mm

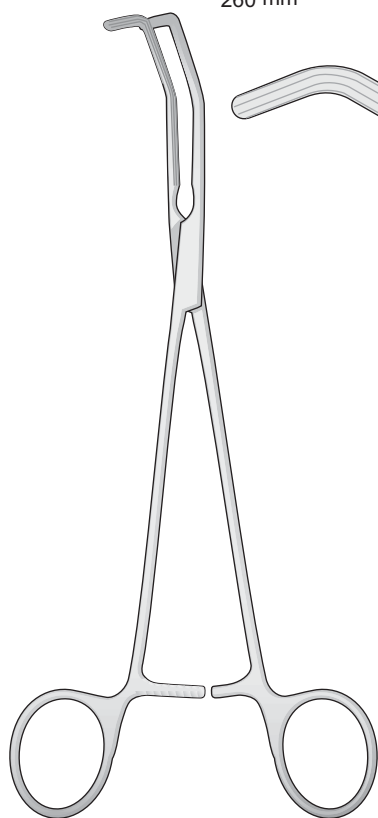

PRICE - THOMAS
FB-52
220 mm

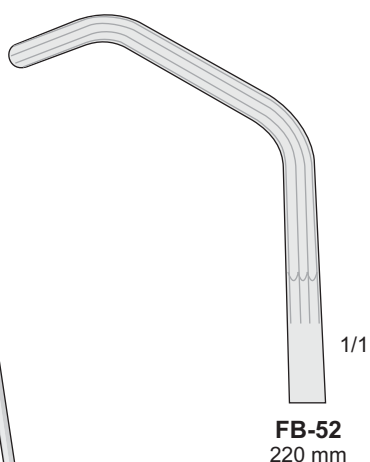

FB-52
220 mm

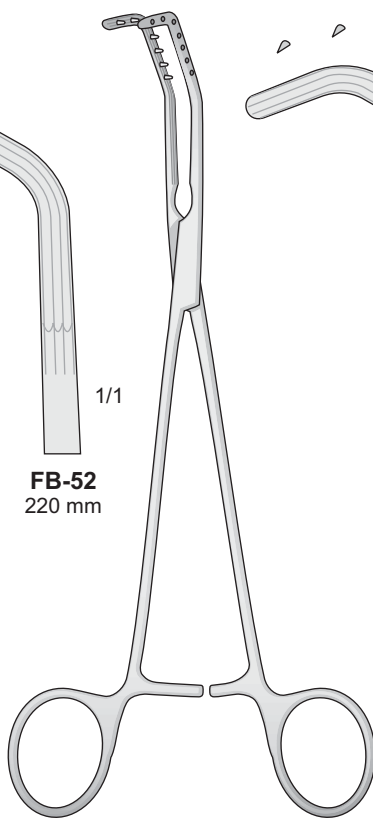

PRICE - THOMAS
FB-53/FB-54

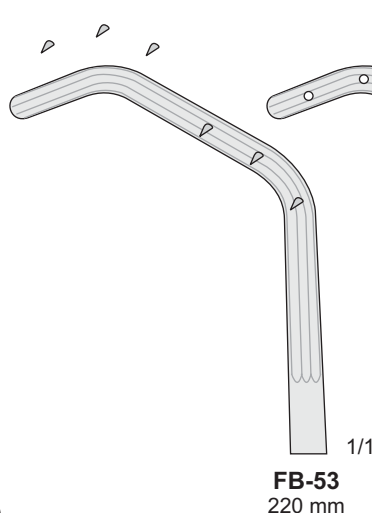

FB-53
220 mm

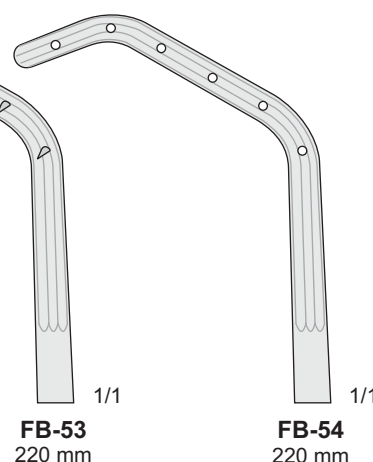

FB-54
220 mm



DE BAKEY
FB-301/FB-312
190 mm



FB-301
Ø 0,5 mm



FB-302
Ø 1,0 mm



FB-303
Ø 1,5 mm



FB-304
Ø 2,0 mm



FB-305
Ø 2,5 mm



FB-306
Ø 3,0 mm



FB-307
Ø 3,5 mm



FB-308
Ø 4,0 mm



FB-309
Ø 4,5 mm



FB-310
Ø 5,0 mm



FB-311
Ø 7,0 mm



FB-312
Ø 9,0 mm

FB-300

Set completo di 12 pezzi
Set complete with 12 pieces
Kompletset mit 12 Stück
Set complet avec 12 pièces
Set completo con 12 piezas

FB-351 - 140 mm - Ø 1,0
FB-352 - 140 mm - Ø 1,5
FB-353 - 140 mm - Ø 2,0
FB-354 - 140 mm - Ø 2,5
FB-355 - 140 mm - Ø 3,0
FB-356 - 140 mm - Ø 3,5
FB-357 - 140 mm - Ø 4,0
FB-358 - 140 mm - Ø 4,5
FB-359 - 140 mm - Ø 5,0

FB-361 - 210 mm - Ø 1,0
FB-362 - 210 mm - Ø 1,5
FB-363 - 210 mm - Ø 2,0
FB-364 - 210 mm - Ø 2,5
FB-365 - 210 mm - Ø 3,0
FB-366 - 210 mm - Ø 3,5
FB-367 - 210 mm - Ø 4,0
FB-368 - 210 mm - Ø 4,5
FB-369 - 210 mm - Ø 5,0

FB-350

Set completo di 9 pezzi
 Set complete with 9 pieces
 Kompletset mit 9 Stück
 Saet complet avec 9 pièces
 Set completo con 9 piezas

FB-360

Set completo di 9 pezzi
 Set complete with 9 pieces
 Kompletset mit 9 Stück
 Saet complet avec 9 pièces
 Set completo con 9 piezas

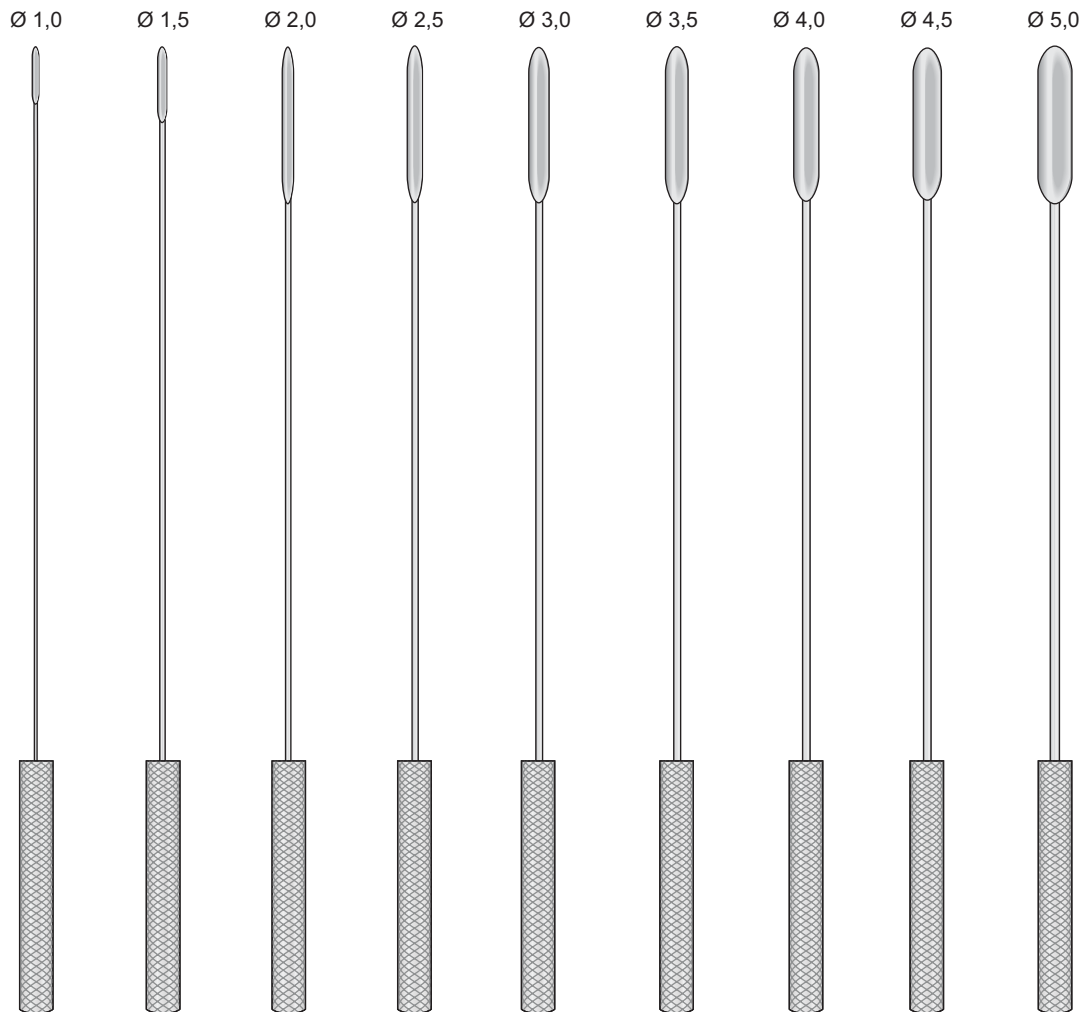

GARRETT
FB-351/FB-369

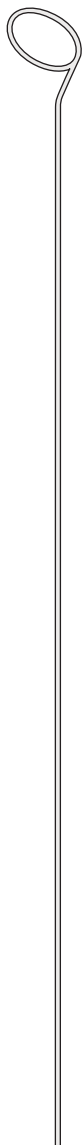

VOLLMAR
FB-381/FB-389
 500 mm

Ø 2 mm
 ○ 1/1
FB-381

Ø 4 mm
 ○ 1/1
FB-383

Ø 7 mm
 ○ 1/1
FB-385

Ø 10 mm
 ○ 1/1
FB-387

Ø 14 mm
 ○ 1/1
FB-389

Ø 3 mm
 ○ 1/1
FB-382

Ø 6 mm
 ○ 1/1
FB-384

Ø 8,5 mm
 ○ 1/1
FB-386

Ø 12 mm
 ○ 1/1
FB-388



FB-380
 120 mm

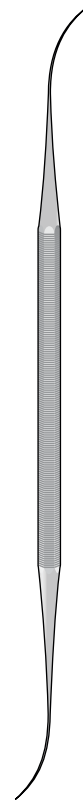

VARADY
FB-107
 180 mm

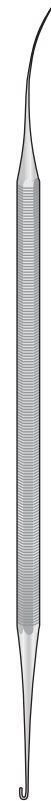

VARADY
FB-108
 180 mm

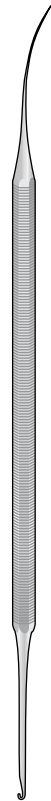

VARADY
FB-109
 180 mm

Aghi vascolari malleabili - Gefäßspülkanülen
 Ø 3 mm Ø 4 mm Ø 5 mm Ø 6 mm

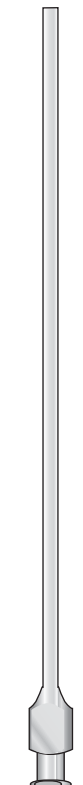

SCHMID
OL-30
 150 mm



SCHMID
OL-31
 150 mm

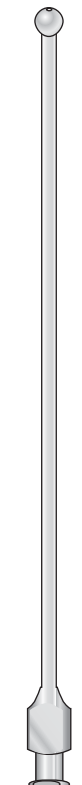

SCHMID
OL-32
 150 mm

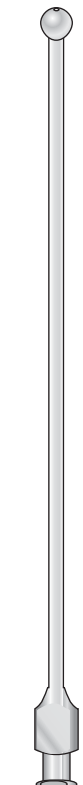

SCHMID
OL-33
 150 mm

AP. 9-45 mm

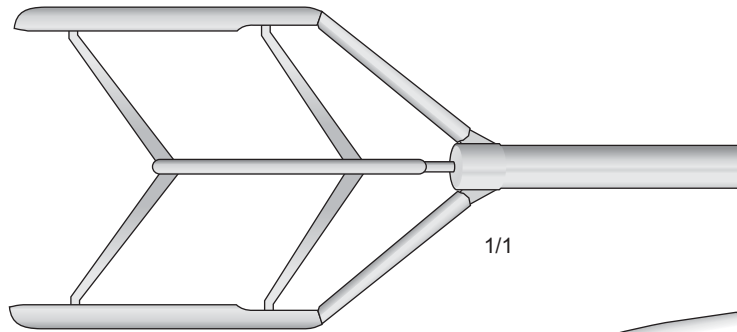

1/1

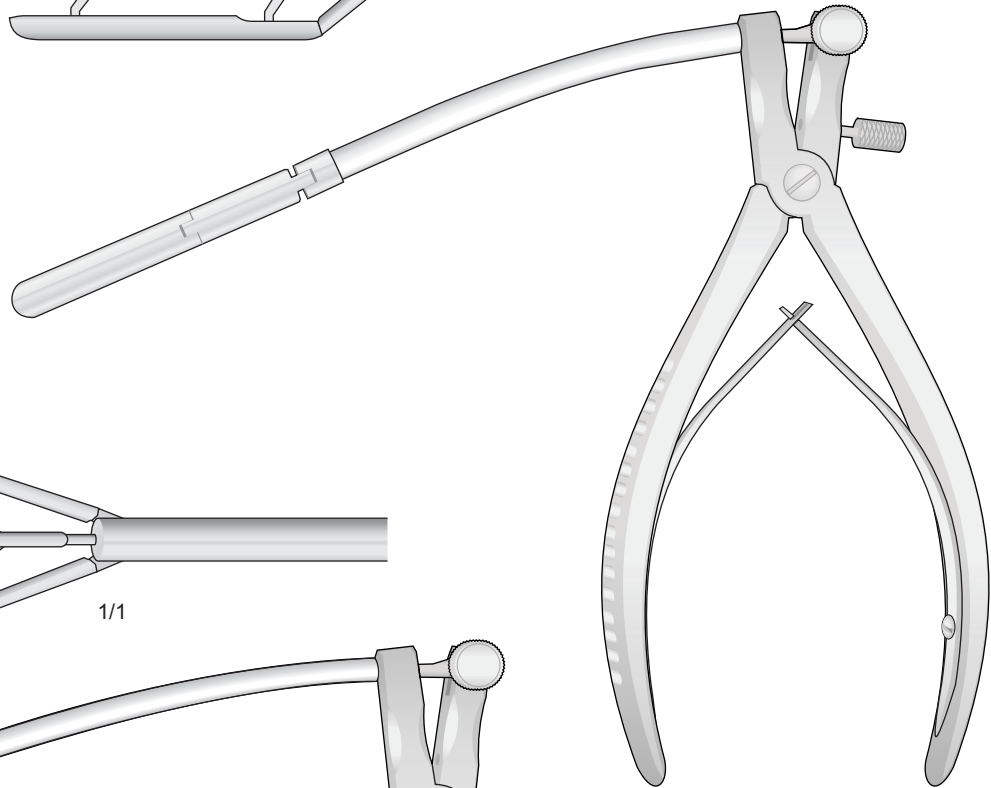

TUBBS
FB-103

AP. 8-15 mm

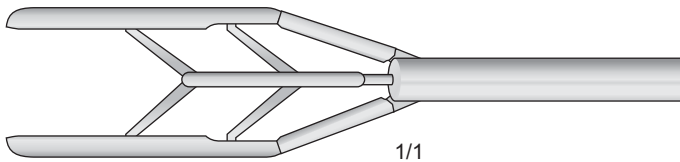

1/1

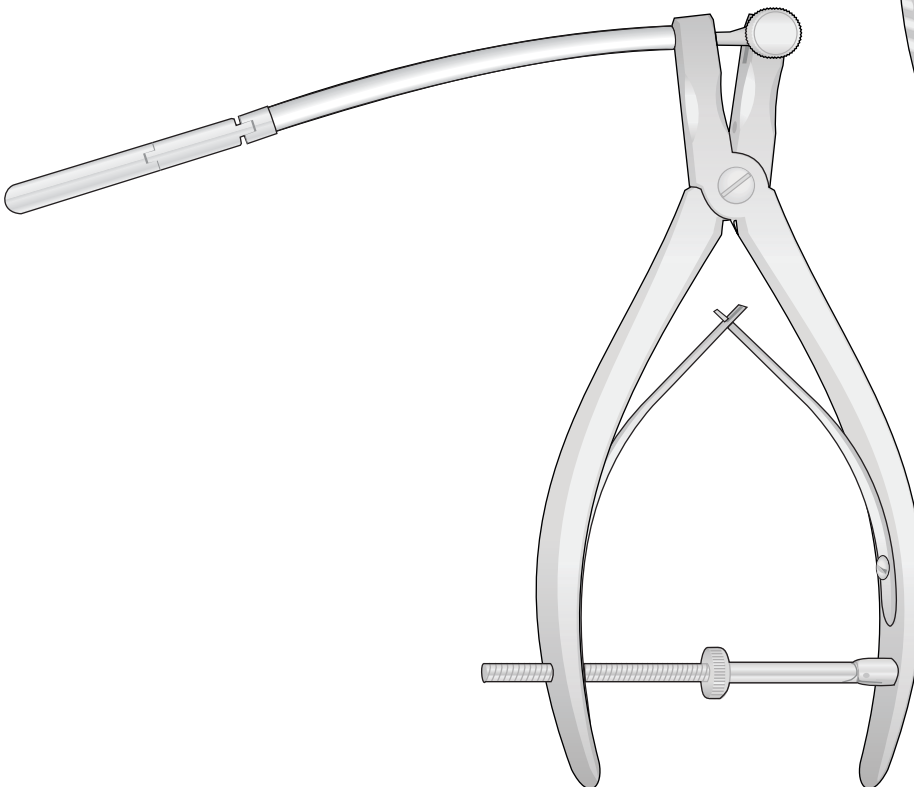

COOLEY
FB-101

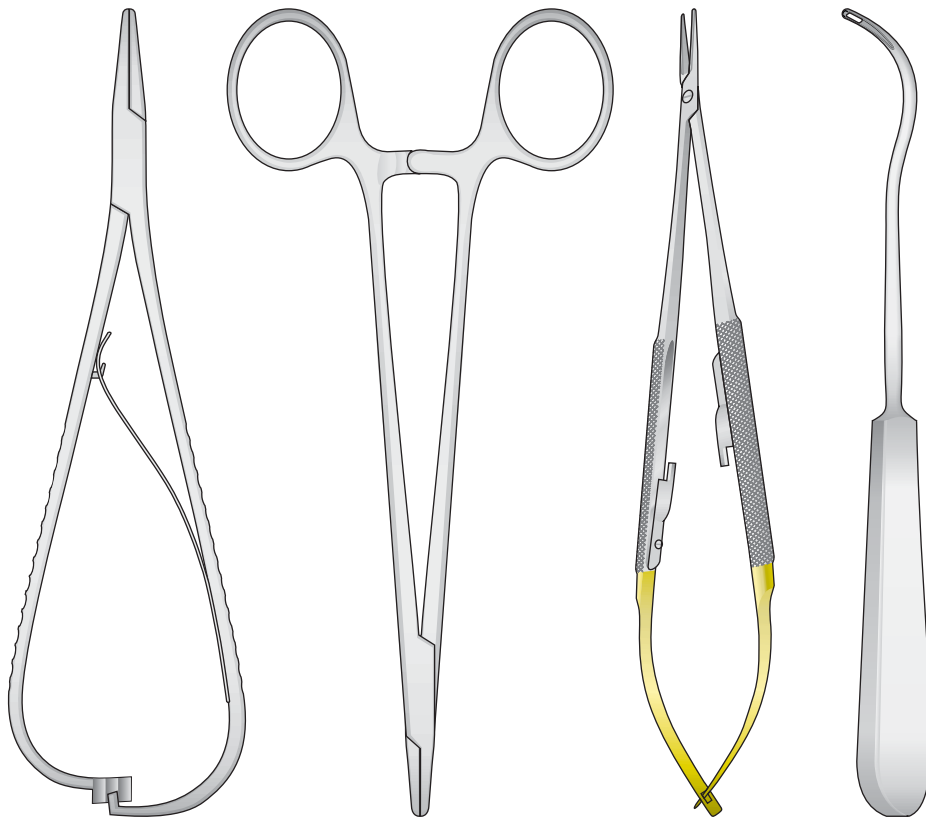

07

Needle Holders | Ligature Needles
Nadelhalter | Unterbindungsnadeln
Porte-aiguilles | Aiguilles à ligatures
Porta-agujas | Agujas para ligaduras
Port'aghi | Aghi per legature

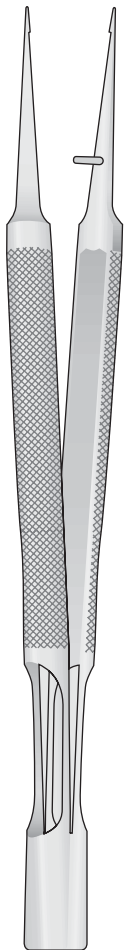
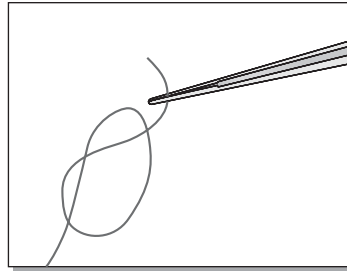

**BROCK
FD-203**
130 mm

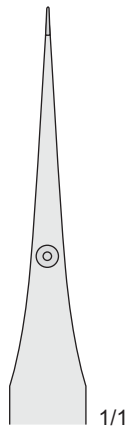

1/1

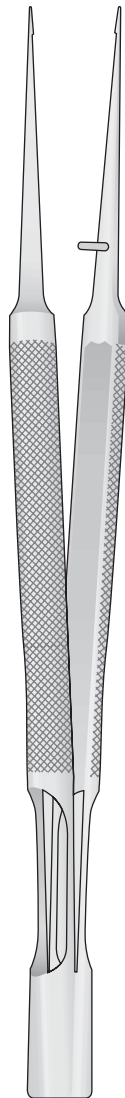

**BROCK
FD-204**
150 mm

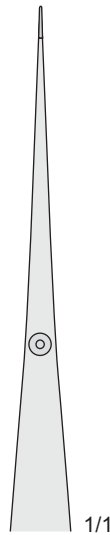

1/1

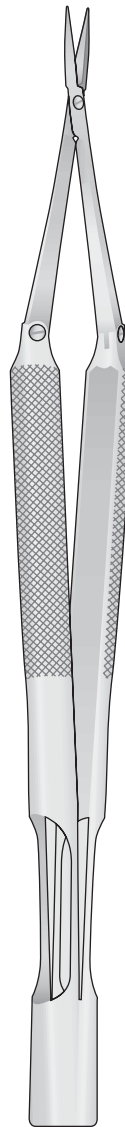

**BROCK
FD-211**
150 mm

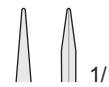

1/1

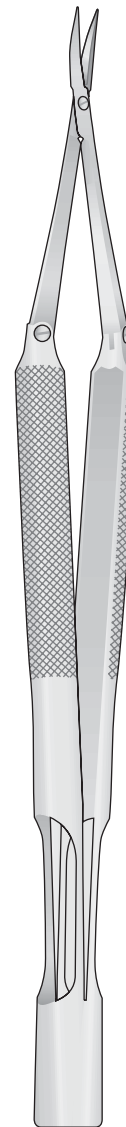

**BROCK
FD-213**
150 mm



1/1

Con morso liscio
Smooth jaws
Glattes Maul
A' mors lisses
Mandibula lisa

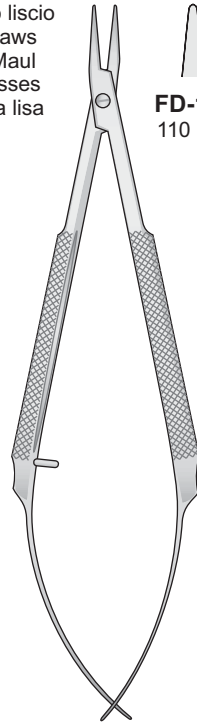

FD-105
110 mm



1/1



FD-106
110 mm

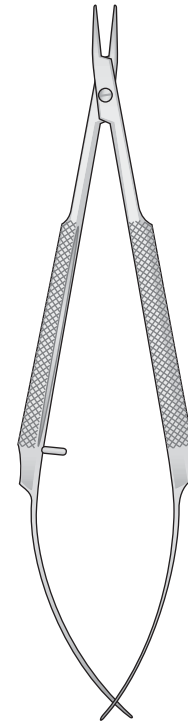

FD-107/FD-108
110 mm



1/1



Con morso liscio
Smooth jaws
Glattes Maul
A' mors lisses
Mandibula lisa

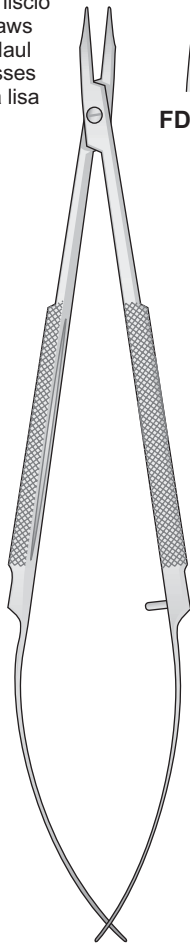

FD-113/FD-114
150 mm



1/1



1/1

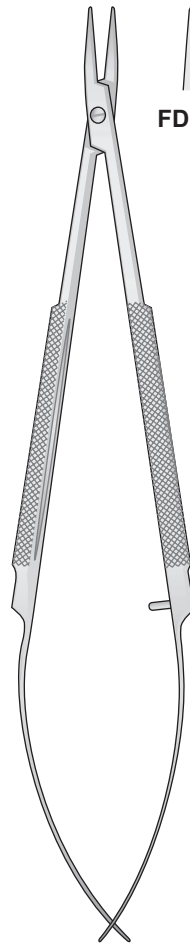

FD-115/FD-116
150 mm



1/1



1/1

Con morso zigrinato fine
Fine serrated jaws
Feingeriefes Maul
Mors stries fins
Bocas estriadas finas

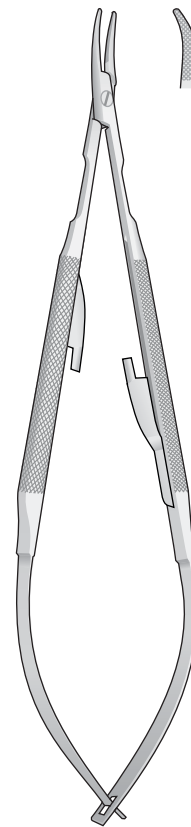

BARRAQUER
FD-24
135 mm



1/1

Con morso liscio - Smooth jaws
 Glattes Maul - A' mors lisses - Mandibula lisa

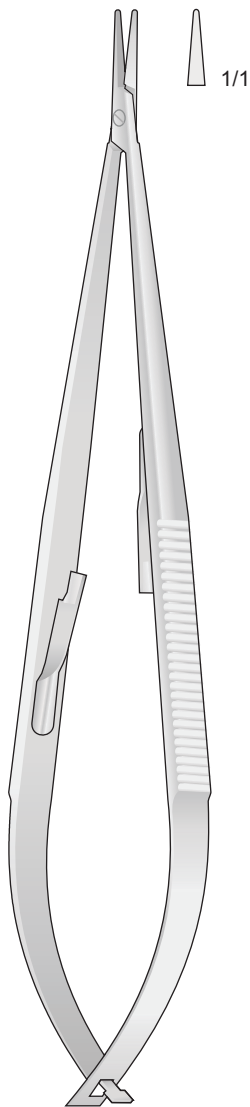

JACOBSON
FD-63
 180 mm

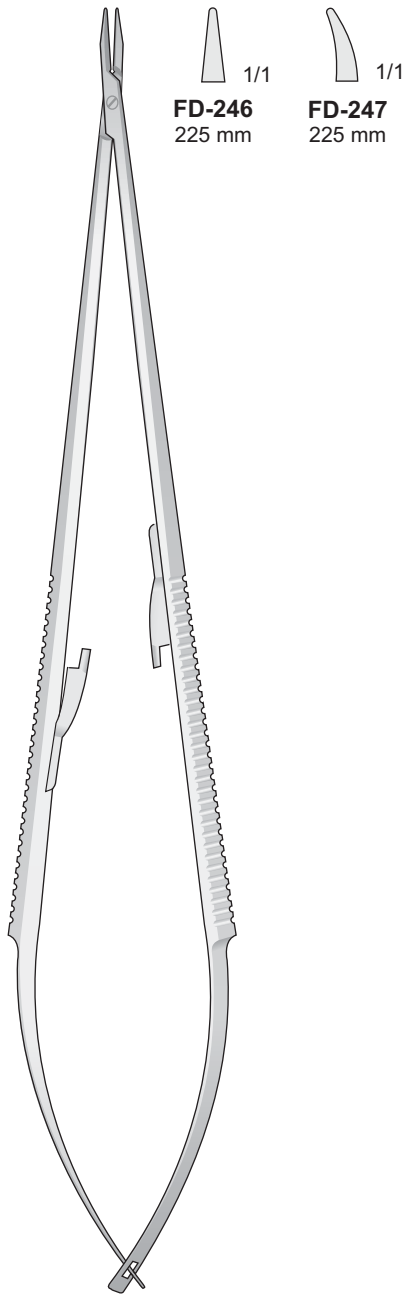

FD-246/FD-247
 225 mm

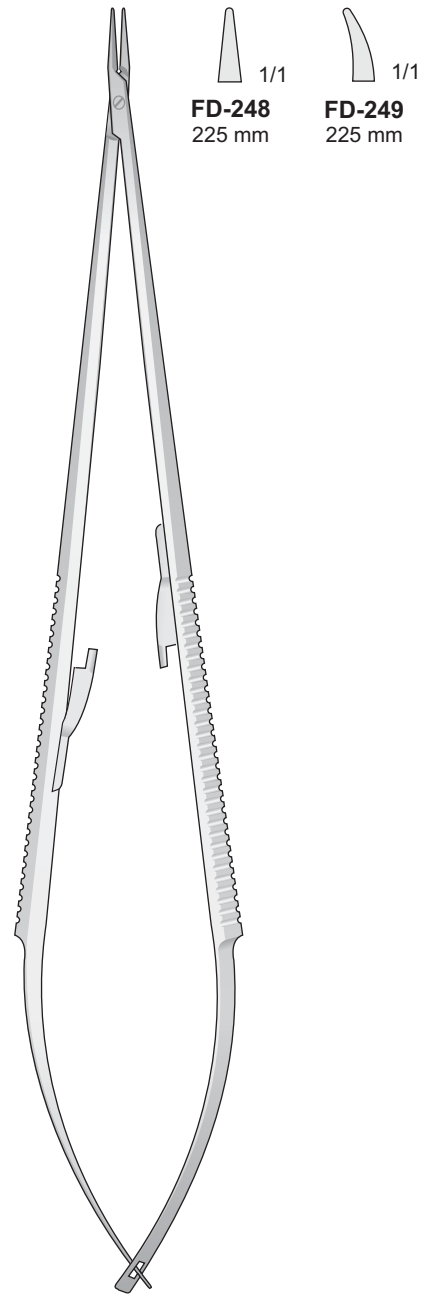

FD-248
 225 mm

FD-249
 225 mm

Portaghi con inserti al tungsteno
 Needle Holders with tungsten-carbide inserts
 Nadelhalter mit Hartmetalleinlagen
 Porte aiguilles avec plaquettes en carbure de tungstène
 Portaagujas con plaquitas de carburo de tungsteno

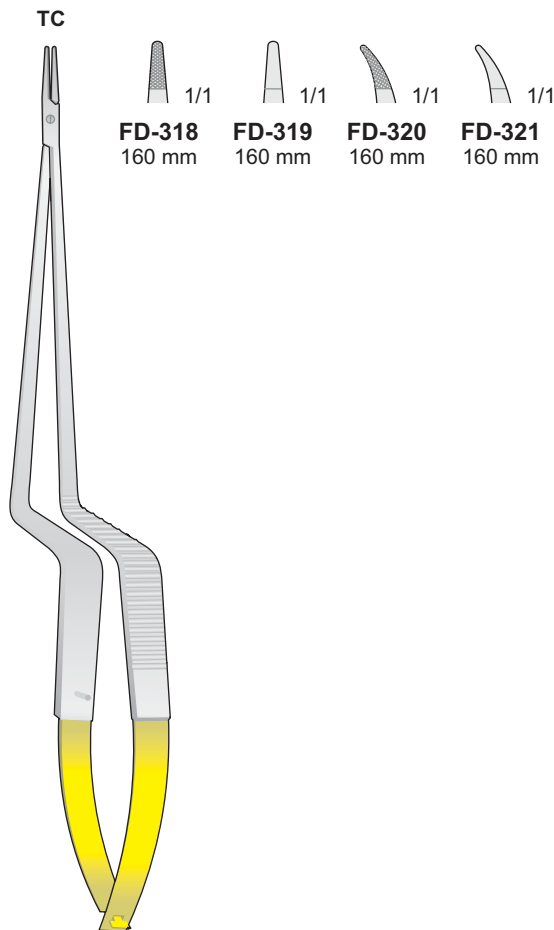

YASARGIL
FD-318/FD-321
 160 mm

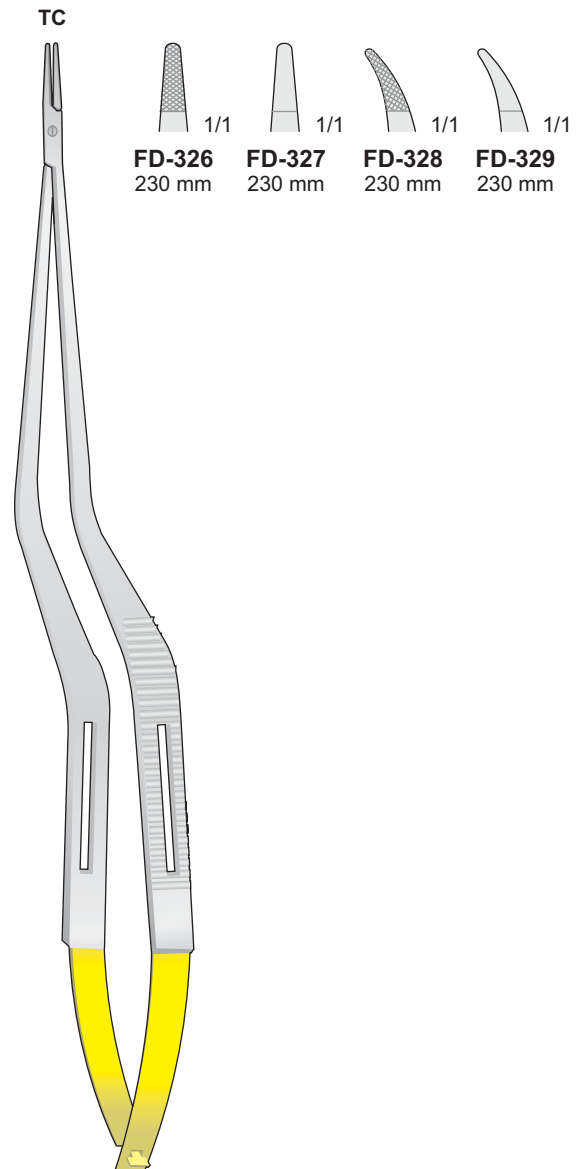

YASARGIL
FD-326/FD-329
 230 mm

Con morso liscio
With smooth jaws
Mit Glatten maul
Avec mors lisses
Con mandibula lisa

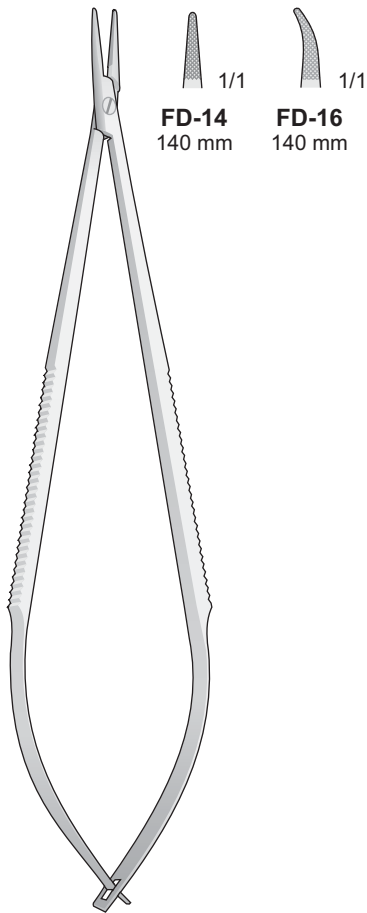

FD-14
140 mm

FD-16
140 mm

FD-14/FD-16
140 mm

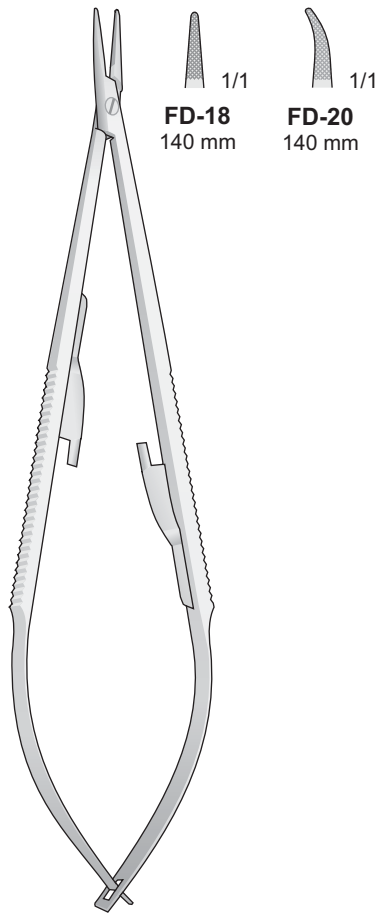

FD-18
140 mm

FD-20
140 mm

CASTROVIEJO
FD-18/FD-20
140 mm

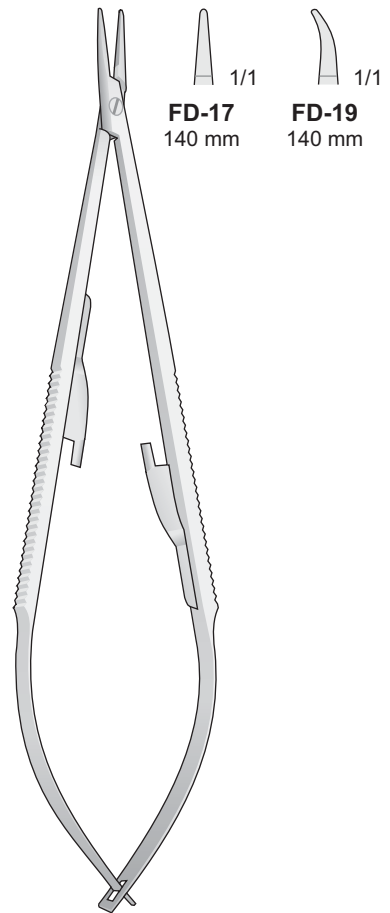

FD-17
140 mm

FD-19
140 mm

CASTROVIEJO
FD-17/FD-19
140 mm

Portaghi con inserti al tungsteno
 Needle Holders with tungsten-carbide inserts
 Nadelhalter mit Hartmetalleinlagen
 Porte aiguilles avec plaquettes en carbure de tungstène
 Portaagujas con plaquitas de carburo de tungsteno

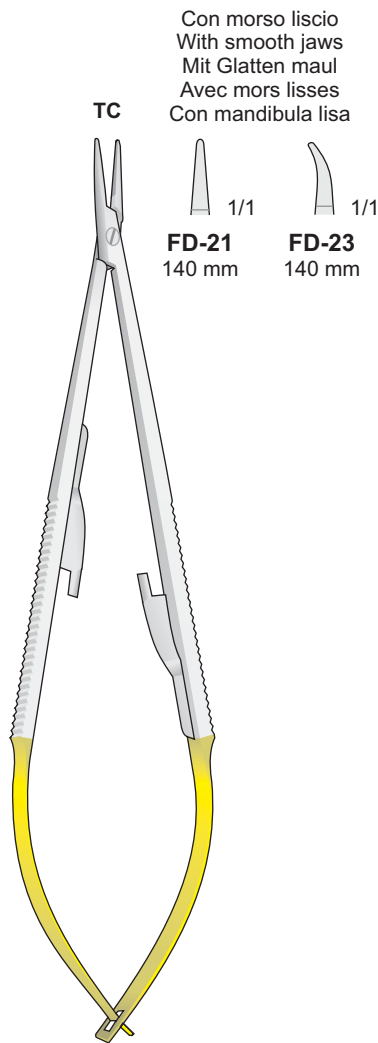

CASTROVIEJO
FD-21/FD-23
 140 mm

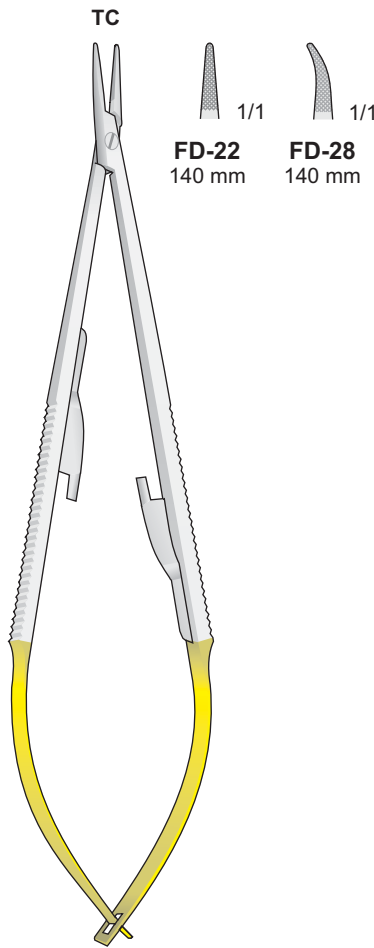

CASTROVIEJO
FD-22/FD-28
 140 mm

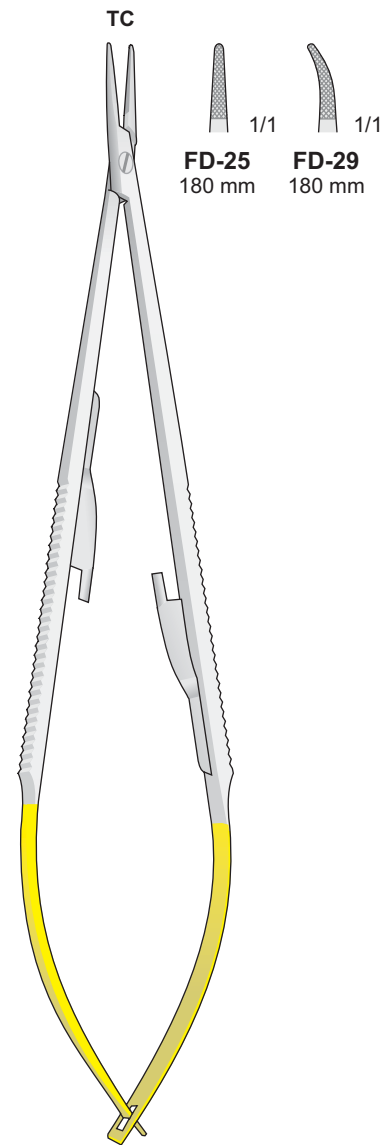

CASTROVIEJO
FD-25/FD-29
 180 mm

Portaghi con inserti al tungsteno
 Needle Holders with tungsten-carbide inserts
 Nadelhalter mit Hartmetalleinlagen
 Porte aiguilles avec plaquettes en carbure de tungstène
 Portaagujas con plaquitas de carburo de tungsteno



Tungsten-Carbide Inserts
 Mit Hartmetalleinsätzen
 Plaquettes en carbure de tungstène
 Plaquetas de carburo de tungsteno
 Inserti in carburo di tungsteno

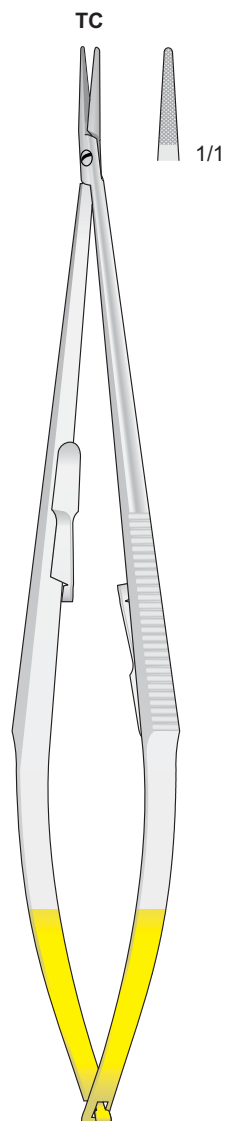

CASTROVIEJO
FD-27
 215 mm

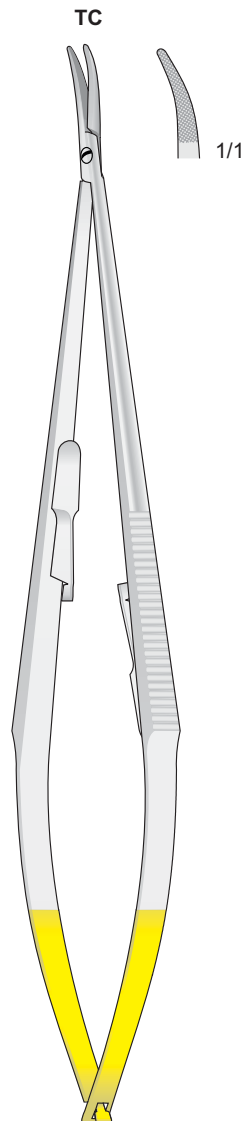

CASTROVIEJO
FD-128
 215 mm

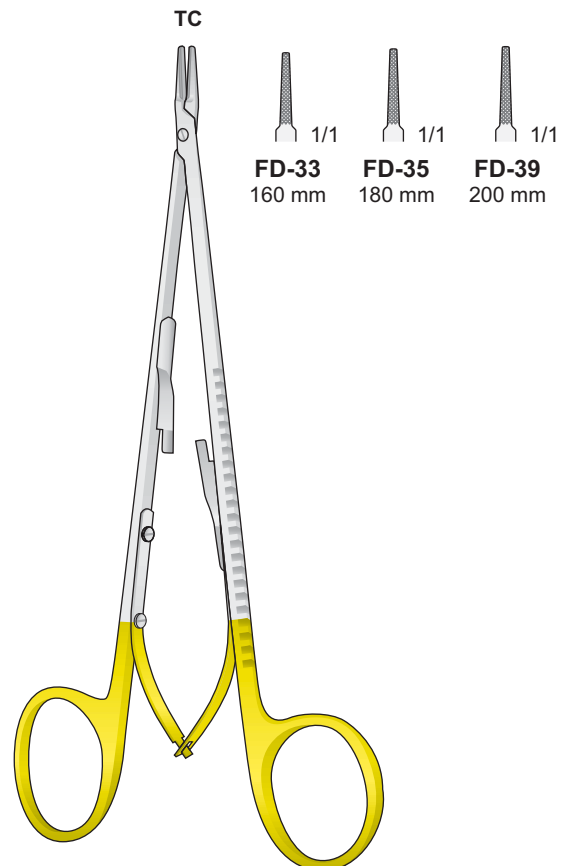

DIETRICH
FD-33/FD-39

Con morso liscio
With smooth jaws
Mit Glatten maul
Avec mors lisses
Con mandibula lisa

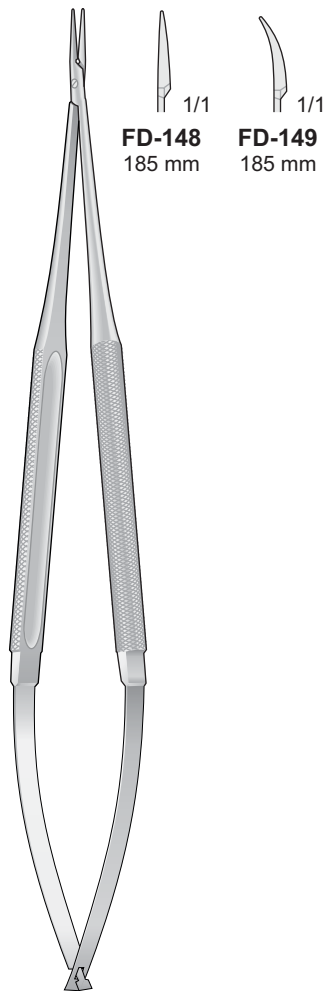

FD-148/FD-149
185 mm

Con morso liscio
With smooth jaws
Mit Glatten maul
Avec mors lisses
Con mandibula lisa

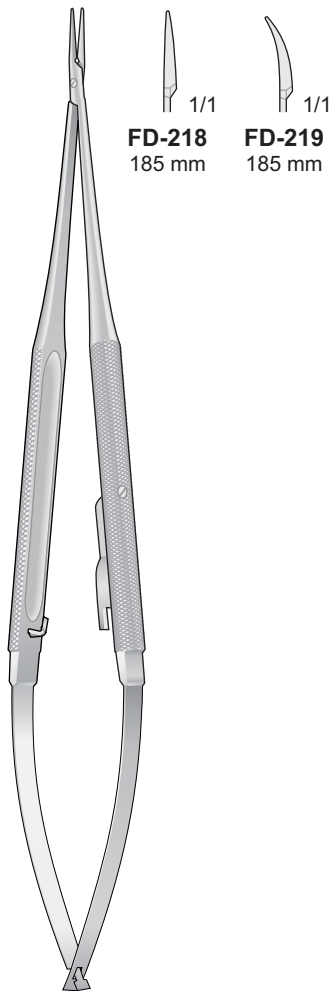

FD-218/FD-219
185 mm

Portaghi con inserti al tungsteno
Needle Holders with tungsten-carbide inserts
Nadelhalter mit Hartmetalleinlagen
Porte aiguilles avec plaquettes en carbure de tungstène
Portaagujas con plaquitas de carburo de tungsteno

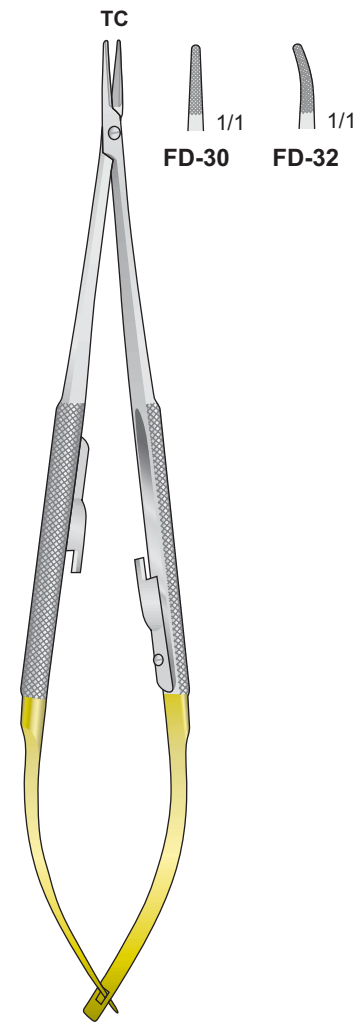

JACOBSON
FD-30/FD-32
180 mm



Tungsten-Carbide Inserts
Mit Hartmetalleinsätzen
Plaquettes en carbure de tungstène
Plaquetas de carburo de tungsteno
Inserti in carburo di tungsteno

Portaghi con inserti al tungsteno
 Needle Holders with tungsten-carbide inserts
 Nadelhalter mit Hartmetalleinlagen
 Porte aiguilles avec plaquettes en carbure de tungstène
 Portaagujas con plaquitas de carburo de tungsteno



Tungsten-Carbide Inserts
 Mit Hartmetalleinsätzen
 Plaquettes en carbure de tungstène
 Plaquetas de carburo de tungsteno
 Inserti in carburo di tungsteno

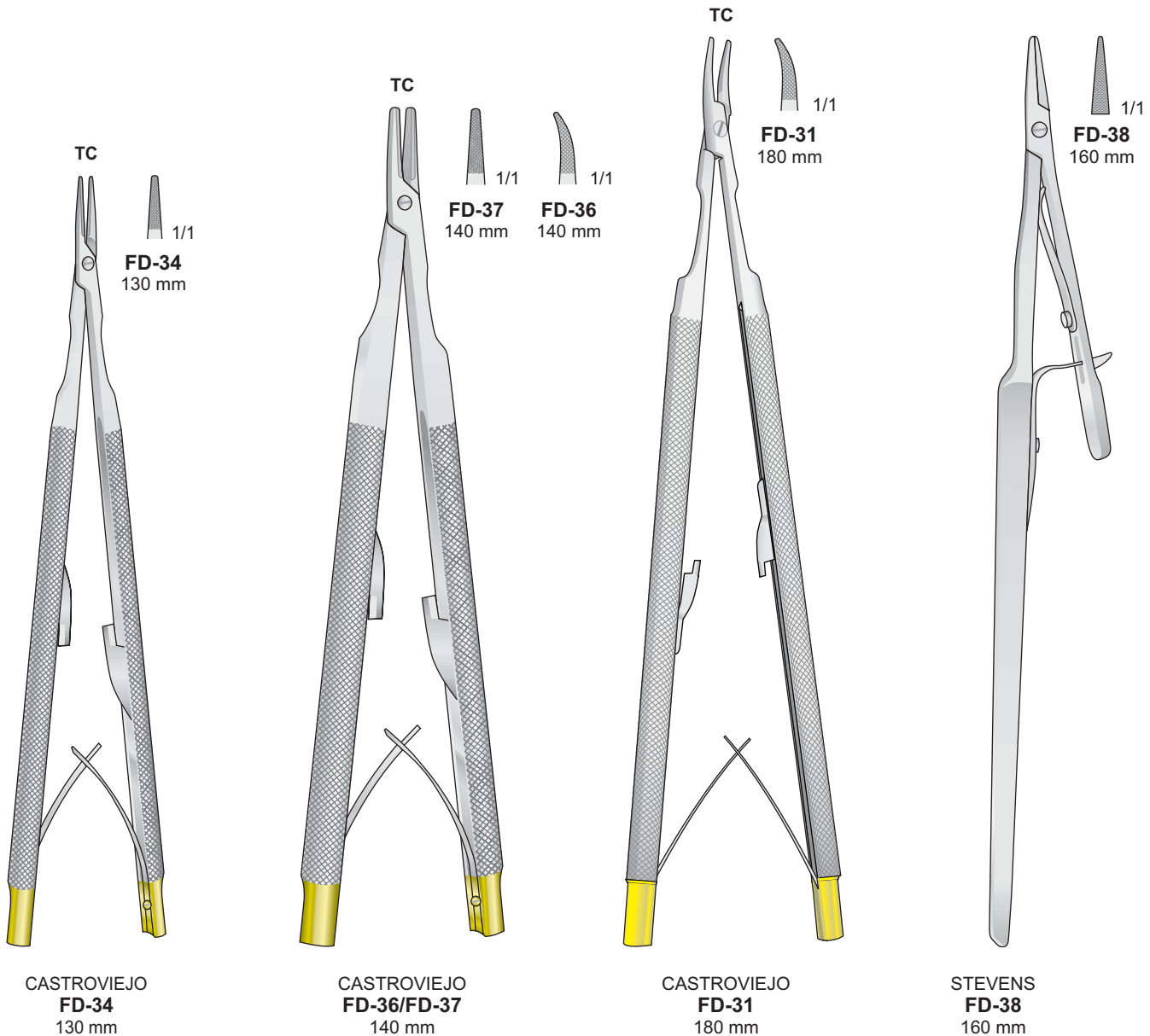

CASTROVIEJO
FD-34
 130 mm

CASTROVIEJO
FD-36/FD-37
 140 mm

CASTROVIEJO
FD-31
 180 mm

STEVENS
FD-38
 160 mm

Con morso liscio
With smooth jaws
Mit Glatten maul
Avec mors lisses
Con mandibula lisa

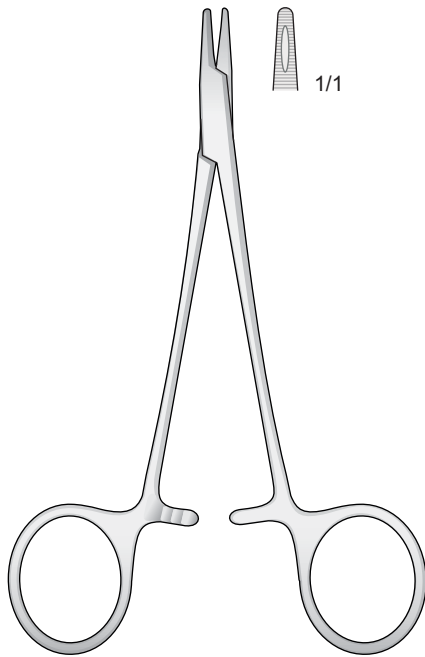

DERF
PH-39
125 mm

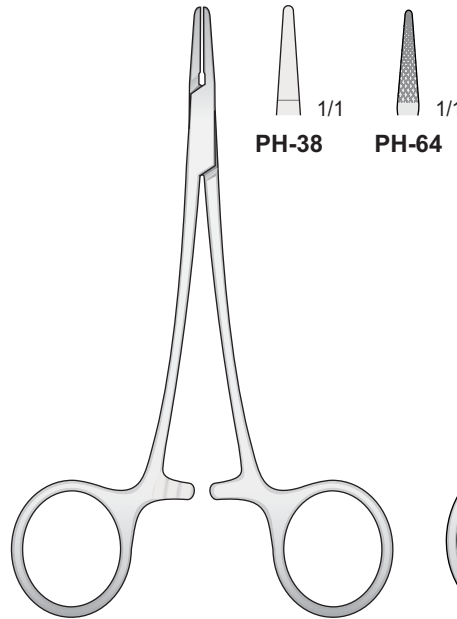

PH-38/PH-64
120 mm

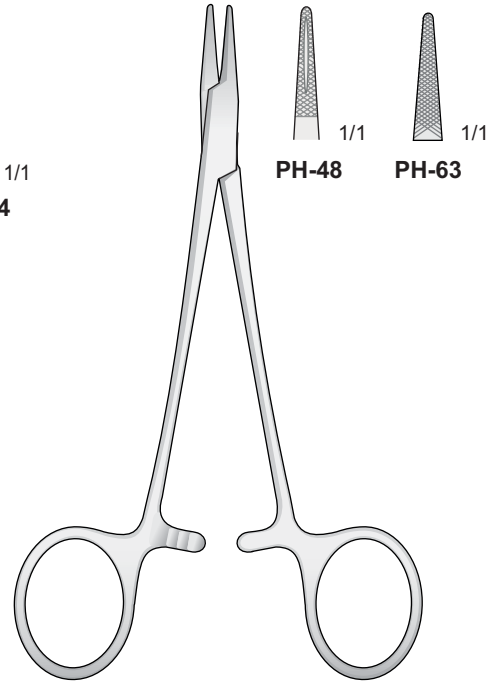

HALSEY
PH-48/PH-63
130 mm

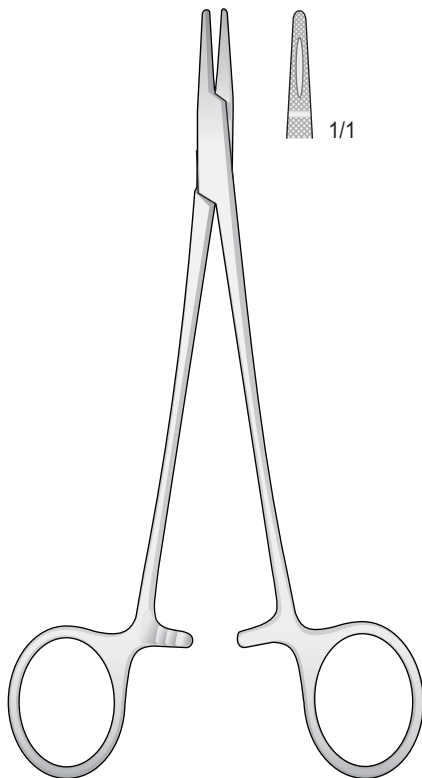

CRILE-WOOD
PH-61
150 mm

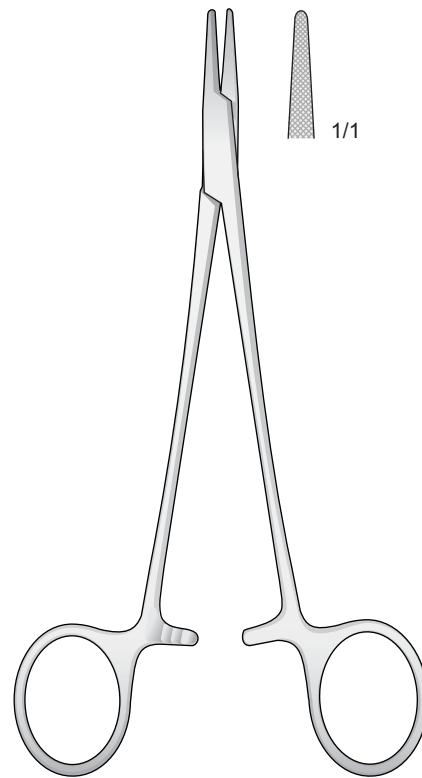

CRILE-MURRAY
PH-62
150 mm

Modello fine - Delicate pattern - Schlanke Modell
Modèle fin - Modelo delegado

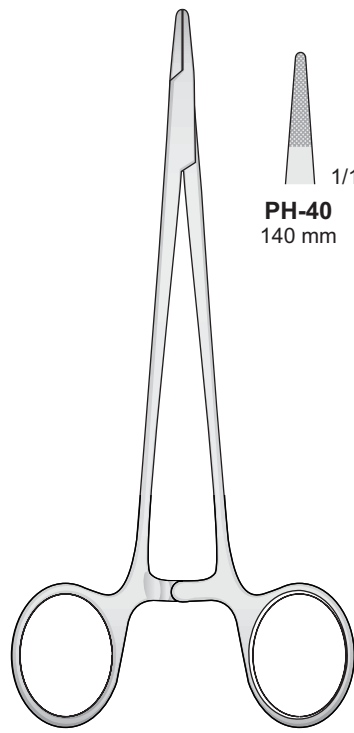

MAYO-HEGAR
PH-40/PH-45

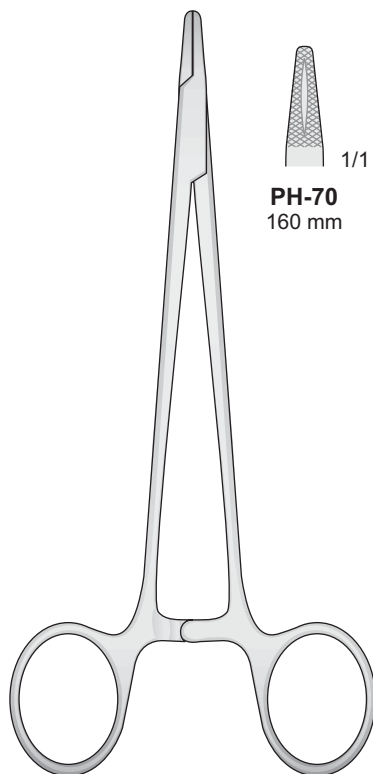
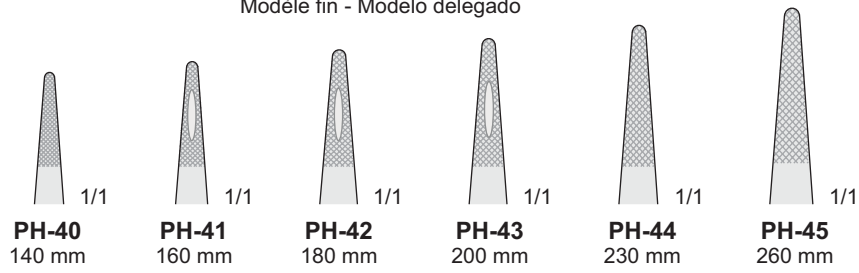

HEGAR
PH-70/PH-78

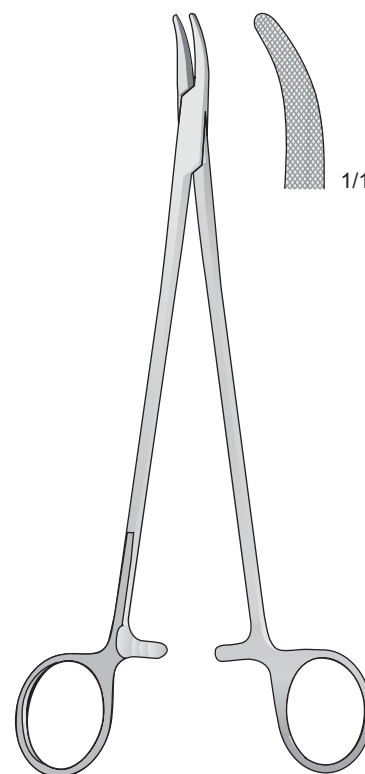
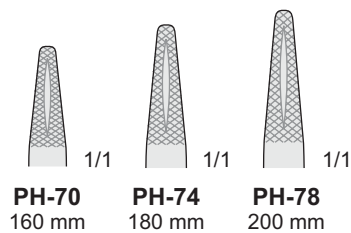

HEANEY (HEGAR)
PH-52
200 mm

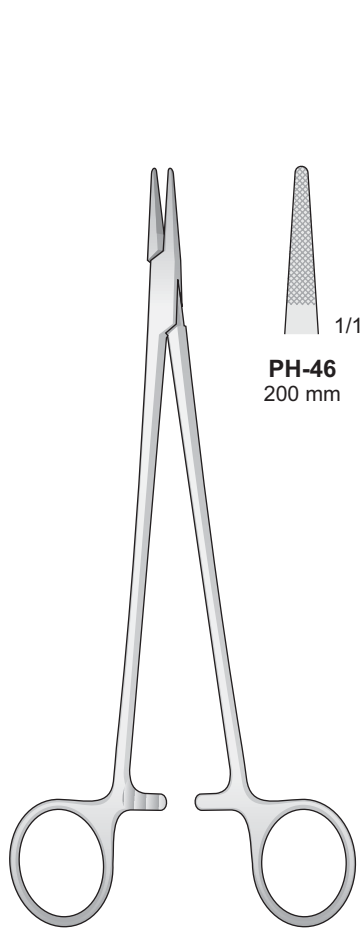

PH-46
200 mm

HEGAR-MAYO-SEELEY
PH-46
200 mm

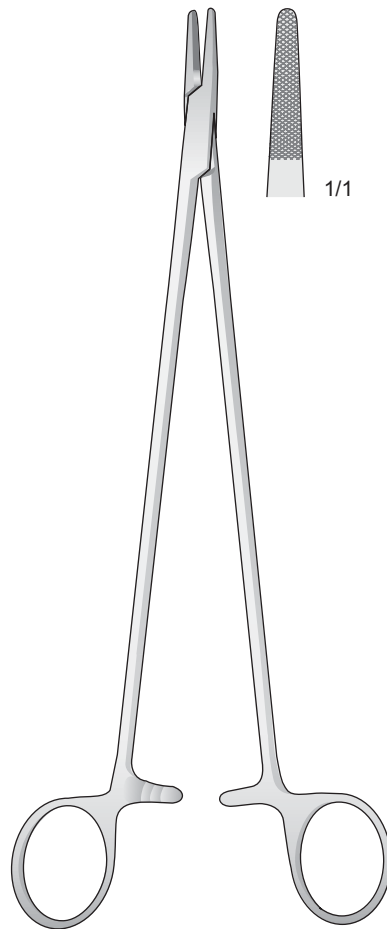

MASSON
PH-47
270 mm

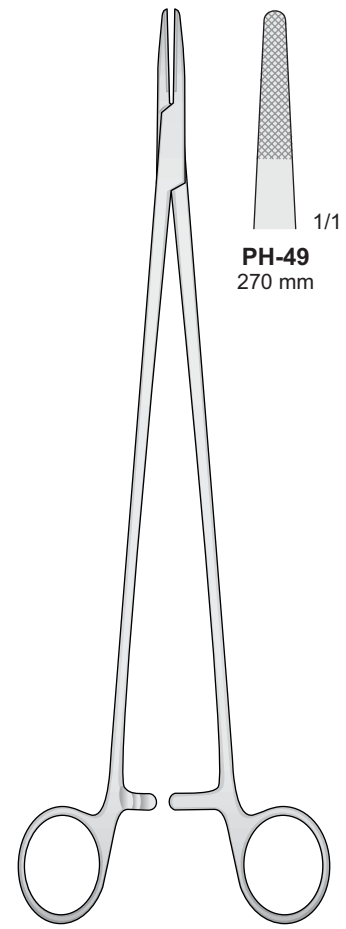

PH-49
270 mm

WANGENSTEEN
PH-49
270 mm

Port'aghi con forbici - Needle holders with scissors - Nadelhalter mit Schere - Porte aiguilles avec ciseaux - Portaagujas con tijeras

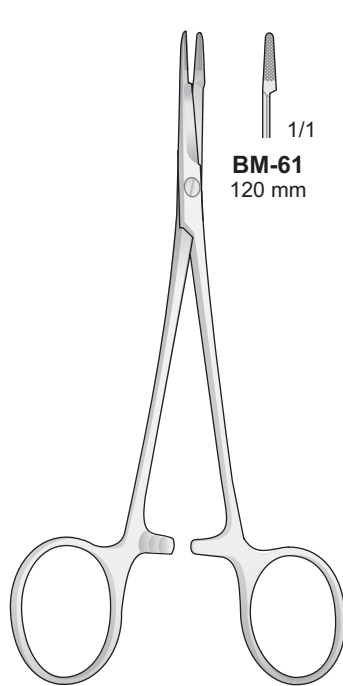

MINI-OLSEN-HEGAR
BM-61
120 mm

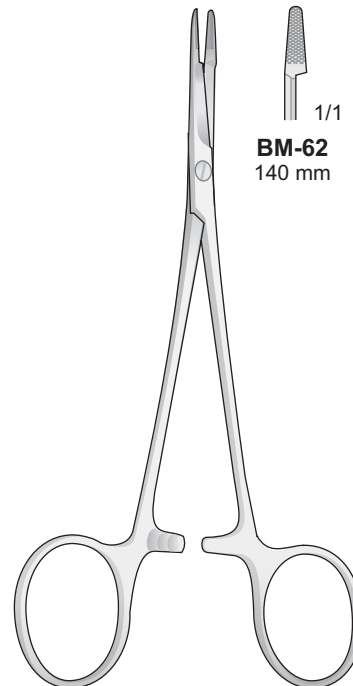

OLSEN-HEGAR
BM-62
140 mm

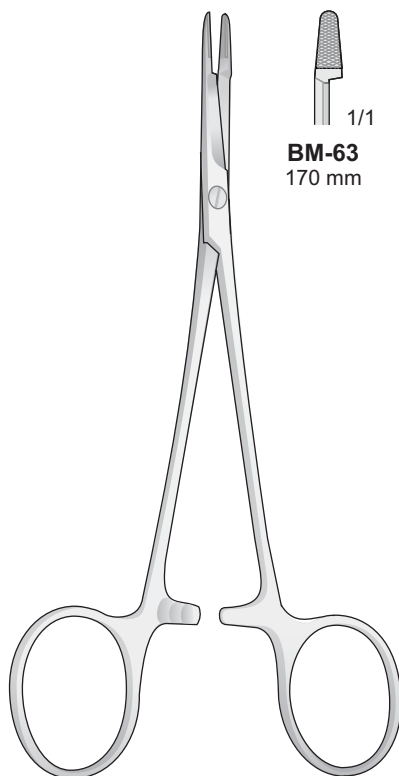

OLSEN-HEGAR
BM-63
170 mm

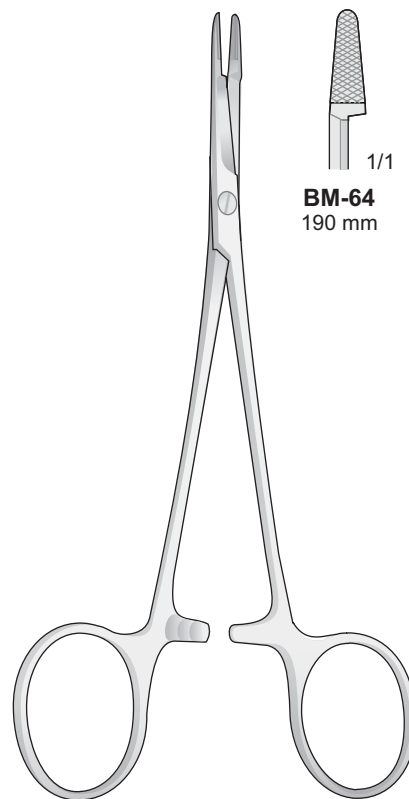

OLSEN-HEGAR
BM-64
190 mm

Port'aghi con forbici - Needle holders with scissors - Nadelhalter mit Schere - Porte aiguilles avec ciseaux - Portaagujas con tijeras

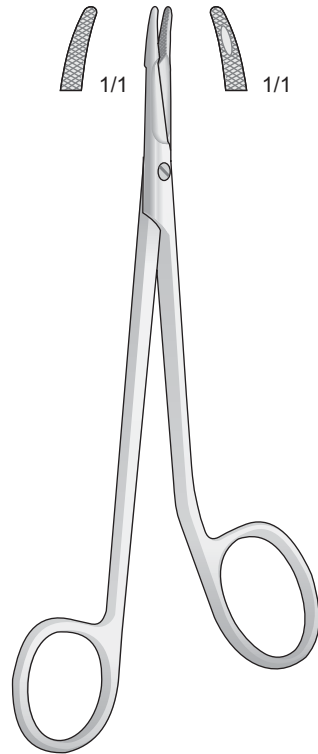

MINI-GILLIES
PO-59
145 mm

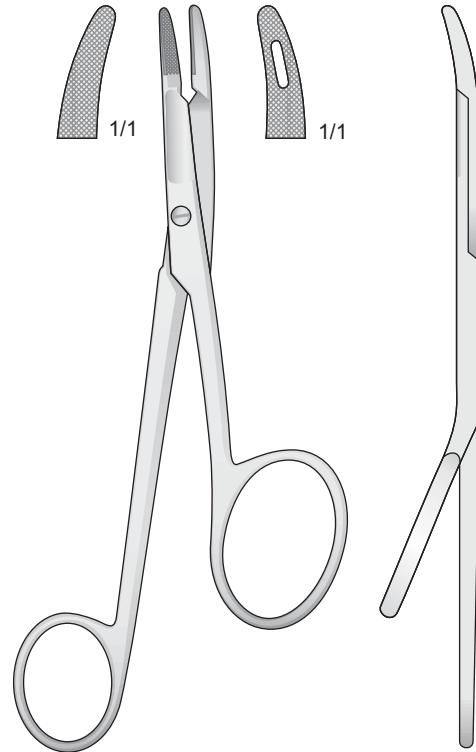

GILLIES
PO-89
160 mm

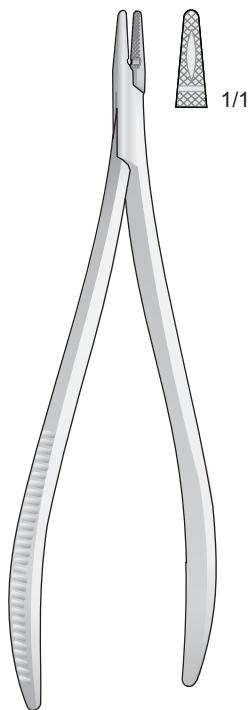

CRILE
PO-37
150 mm

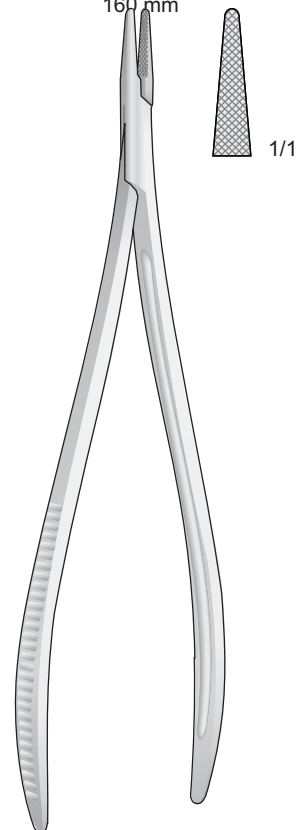

TÖNNIS
PO-38
190 mm

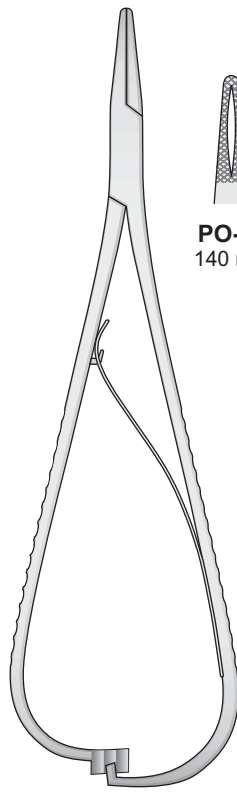

MATHIEU
PO-78/PO-91

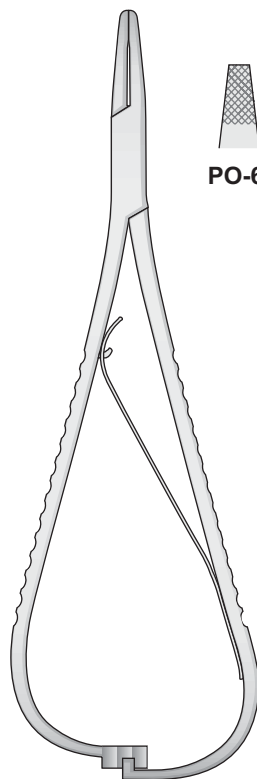
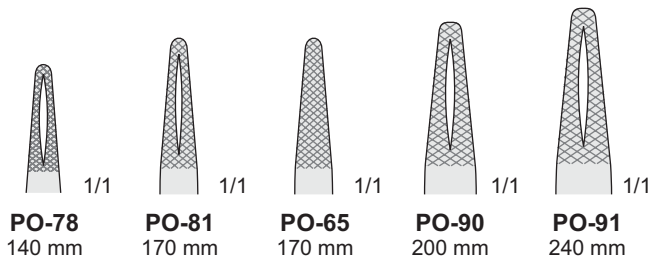

MATHIEU
PO-60/PO-80
140 mm

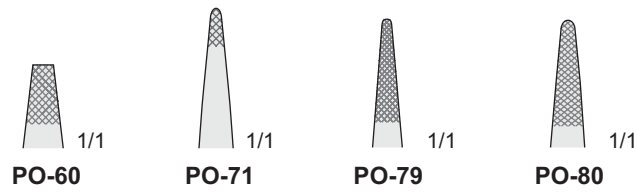

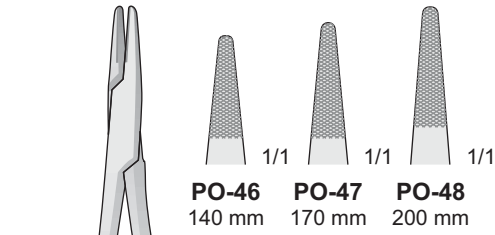

MATHIEU
PO-46/PO-48

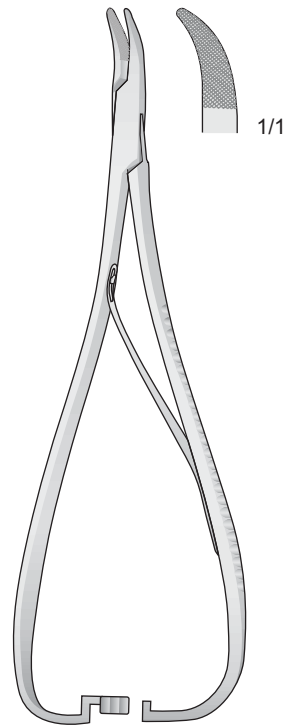

PO-40
140 mm

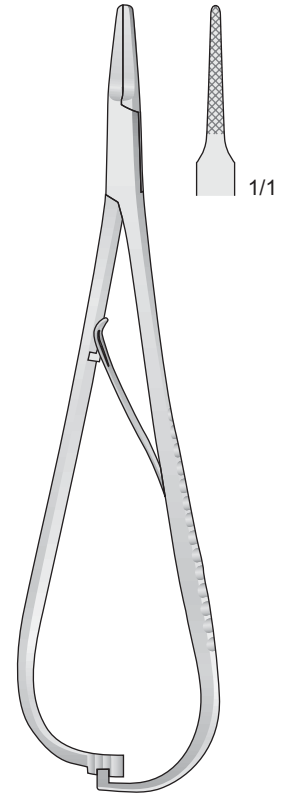

STILLE
PO-74
170 mm

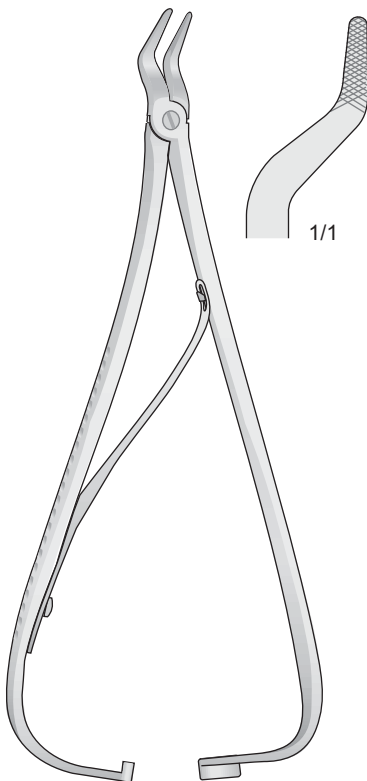

EISELBERG-MATHIEU
PO-75
180 mm

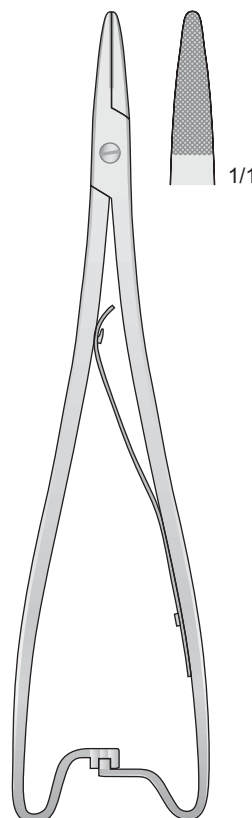

MATHIEU
PO-67
200 mm

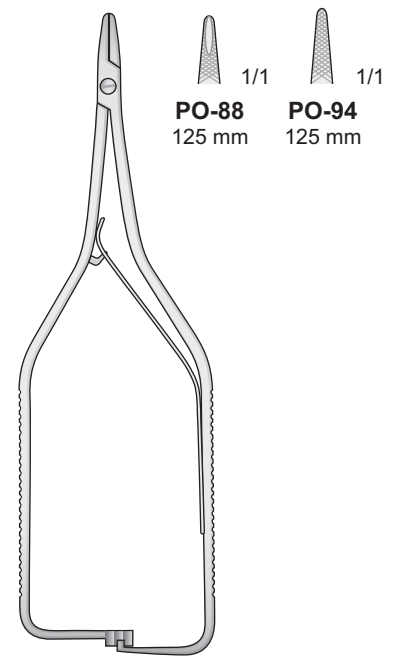

BOYNTON
PO-88/PO-94
125 mm

Portaghi con inserti al tungsteno - Needle Holders with tungsten-carbide inserts
 Nadelhalter mit Hartmetalleinlagen - Porte aiguilles avec plaquettes en carbure de tungstène
 Portaagujas con plaquitas de carburo de tungsteno

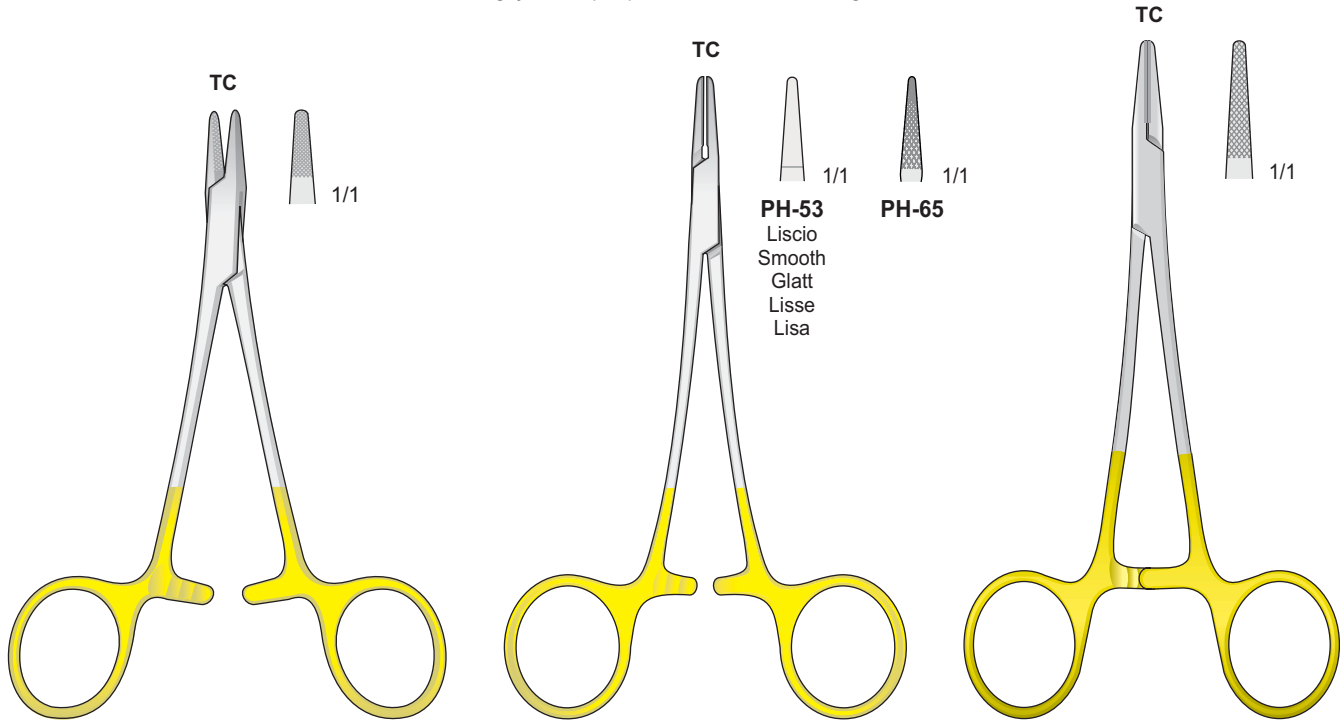

DERF
PH-69
 115 mm

PH-53/PH-65
 120 mm

CONVERSE
PH-68
 130 mm

TC
TUNGSTEN CARBIDE
Tungsten-Carbide Inserts
 Mit Hartmetalleinsätzen
 Plaquettes en carbure de tungstène
 Plaquetas de carburo de tungsteno
 Inserti in carburo di tungsteno

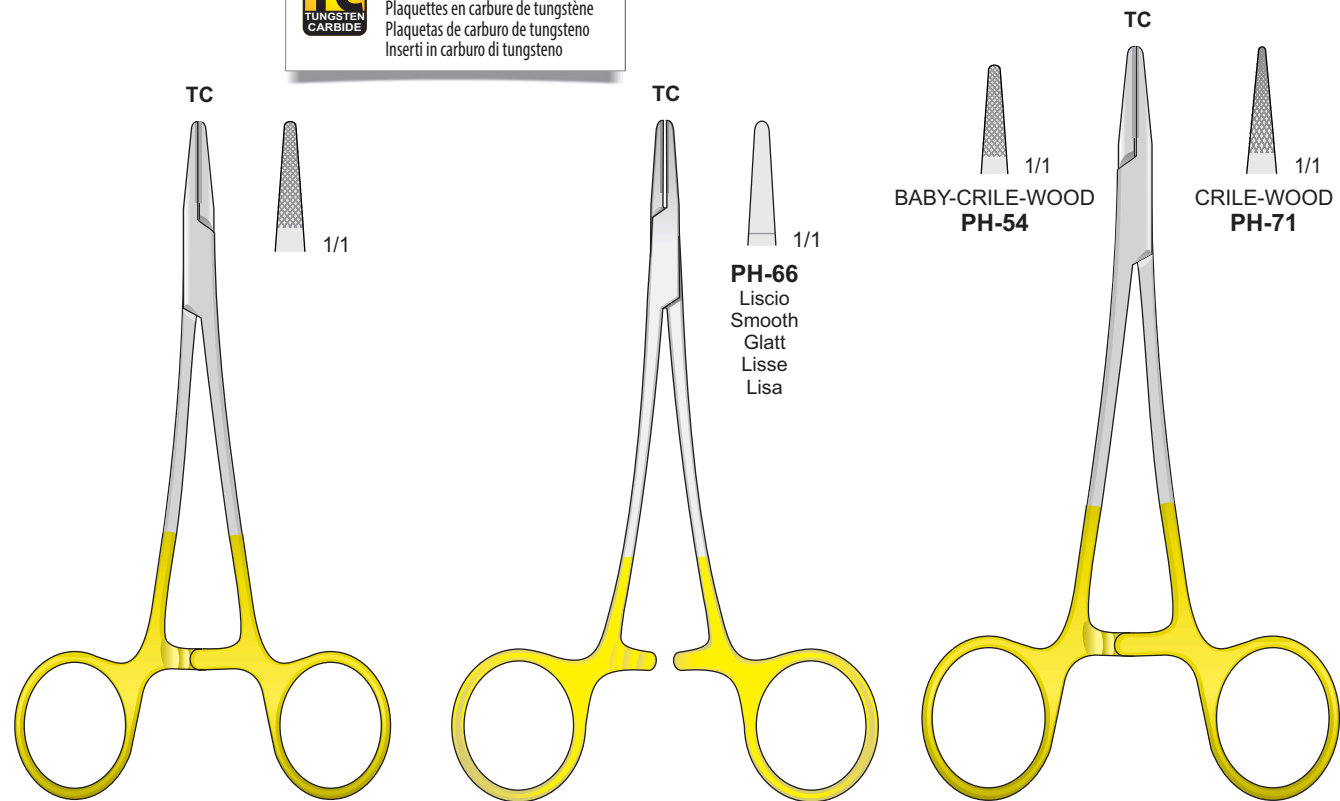

HALSEY
PH-73
 130 mm

WEBSTER
PH-66
 130 mm

CRILE-WOOD
PH-54/PH-71
 150 mm

Portaghi con inserti al tungsteno - Needle Holders with tungsten-carbide inserts
 Nadelhalter mit Hartmetalleinlagen - Porte aiguilles avec plaquettes en carbure de tungstène
 Portaagujas con plaquitas de carburo de tungsteno

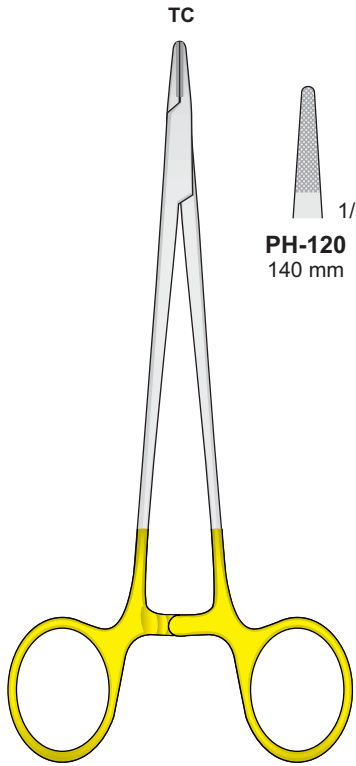

MAYO-HEGAR
PH-120/PH-125

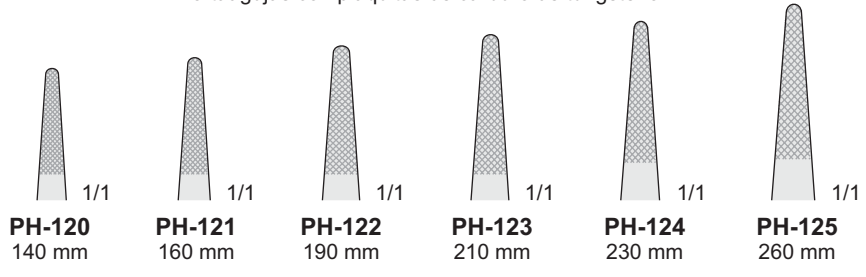

TC
TUNGSTEN
CARBIDE

Tungsten-Carbide Inserts
 Mit Hartmetalleinsätzen
 Plaquettes en carbure de tungstène
 Plaquetas de carburo de tungsteno
 Inserti in carburo di tungsteno

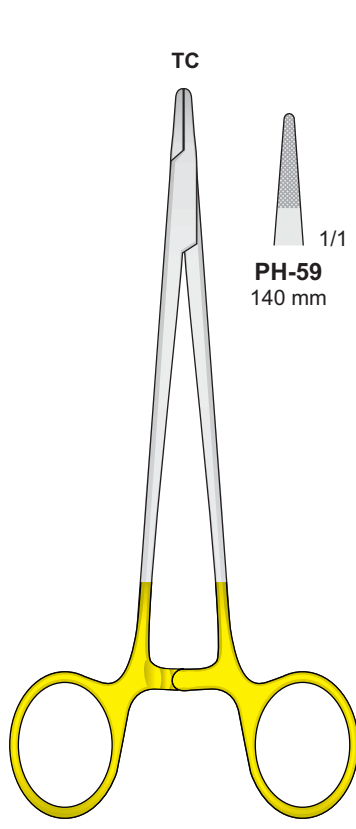

HEGAR
PH-59/PH-76

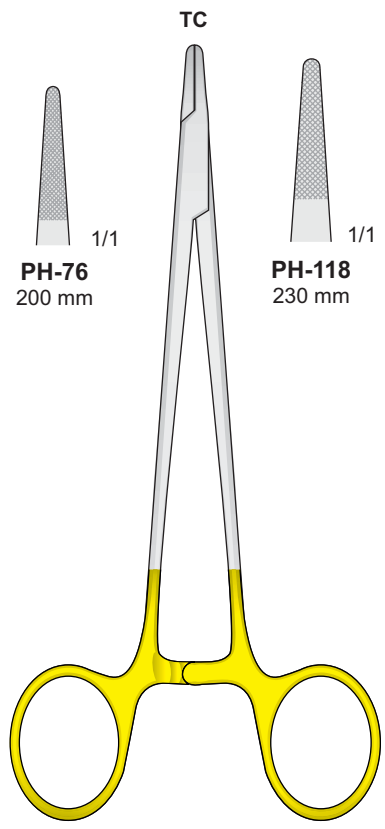
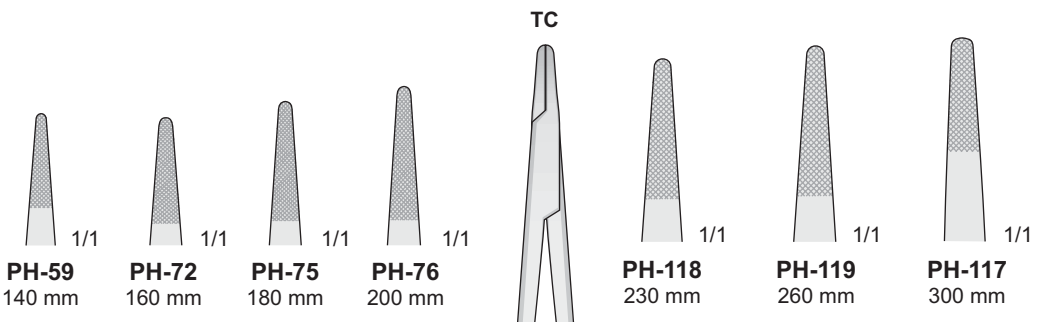

MAYO-HEGAR
PH-117/PH-119

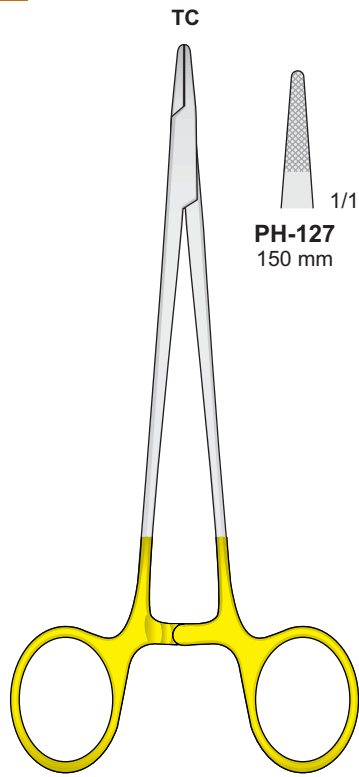

MAYO-HEGAR-FINO
PH-127/PH-129

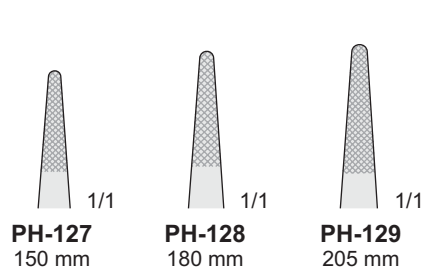

TC
TUNGSTEN
CARBIDE

Tungsten-Carbide Inserts
Mit Hartmetalleinsätzen
Plaquettes en carbure de tungstène
Plaquetas de carburo de tungsteno
Inserti in carburo di tungsteno

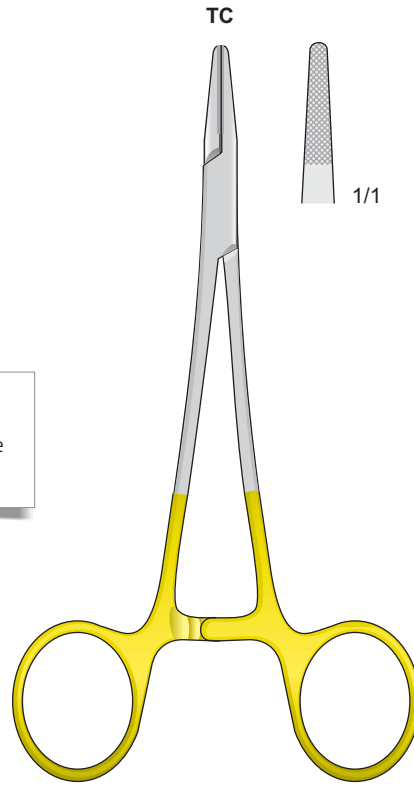

CRILE-WOOD
PH-77
180 mm

Port'aghi, pinze per fili d'acciaio
Needle holder, wire forceps
Nadelhalter, Draht-Zangen
Porte-aiguilles, pincés à saisir
Porta agujas, pinzas para hilos

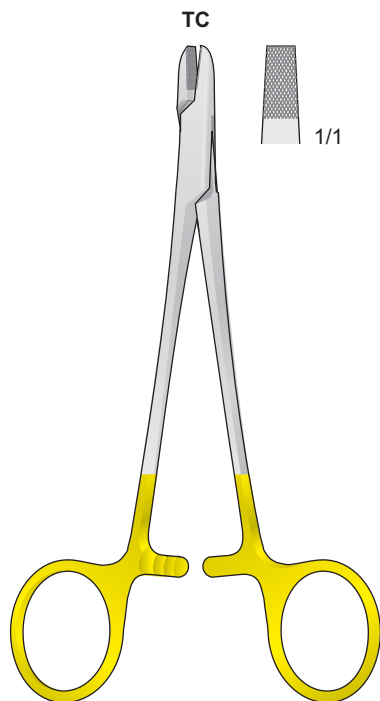

PH-58
150 mm

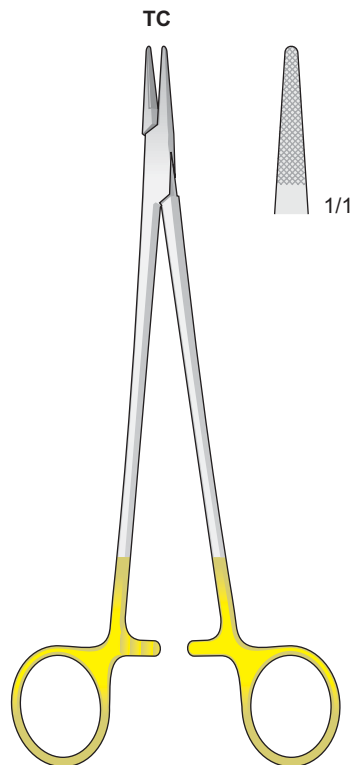

HEGAR-MAYO-SEELEY
PH-130
200 mm

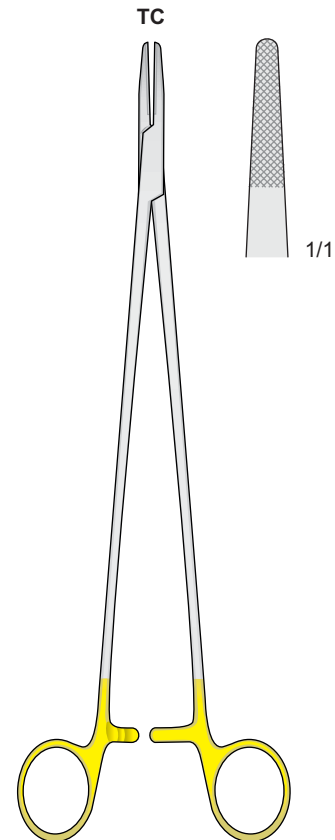

WANGENSTEEN
PH-131
270 mm

Port'aghi con forbici - Needle holders with scissors - Nadelhalter mit Schere - Porte aiguilles avec ciseaux - Portaagujas con tijeras

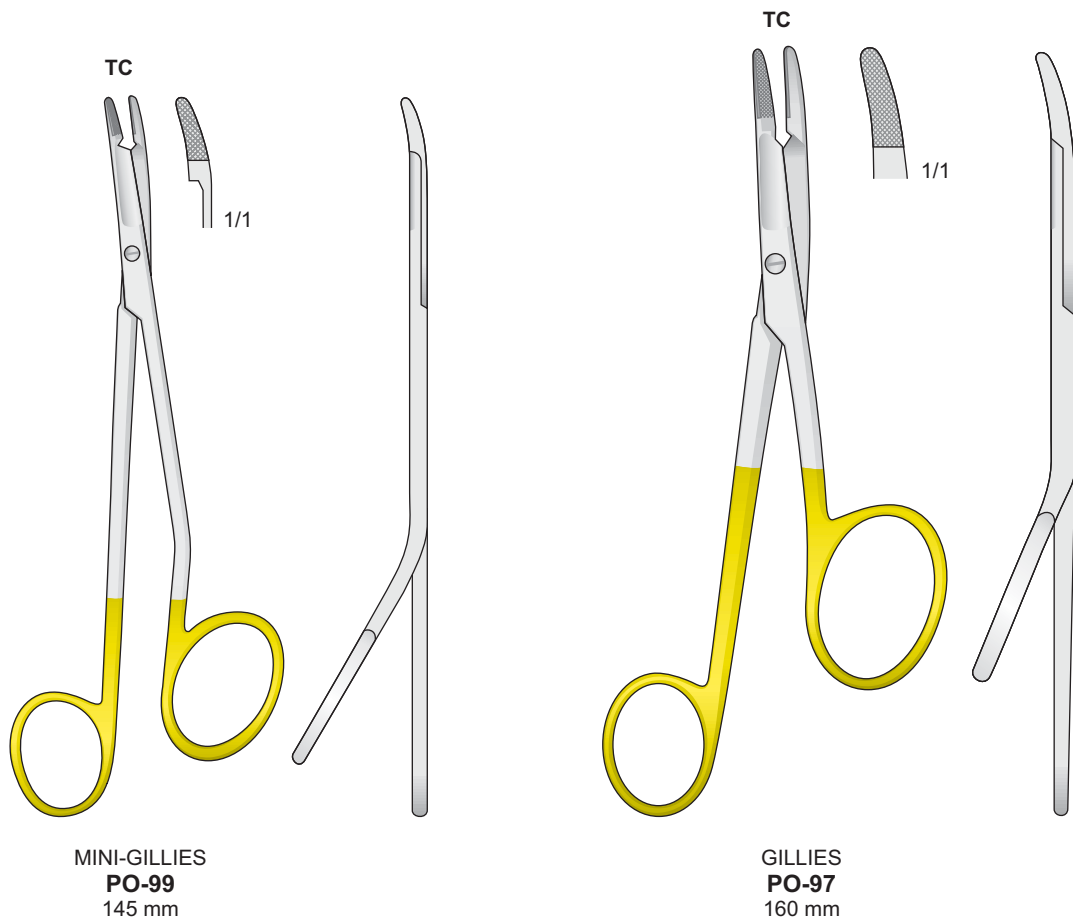
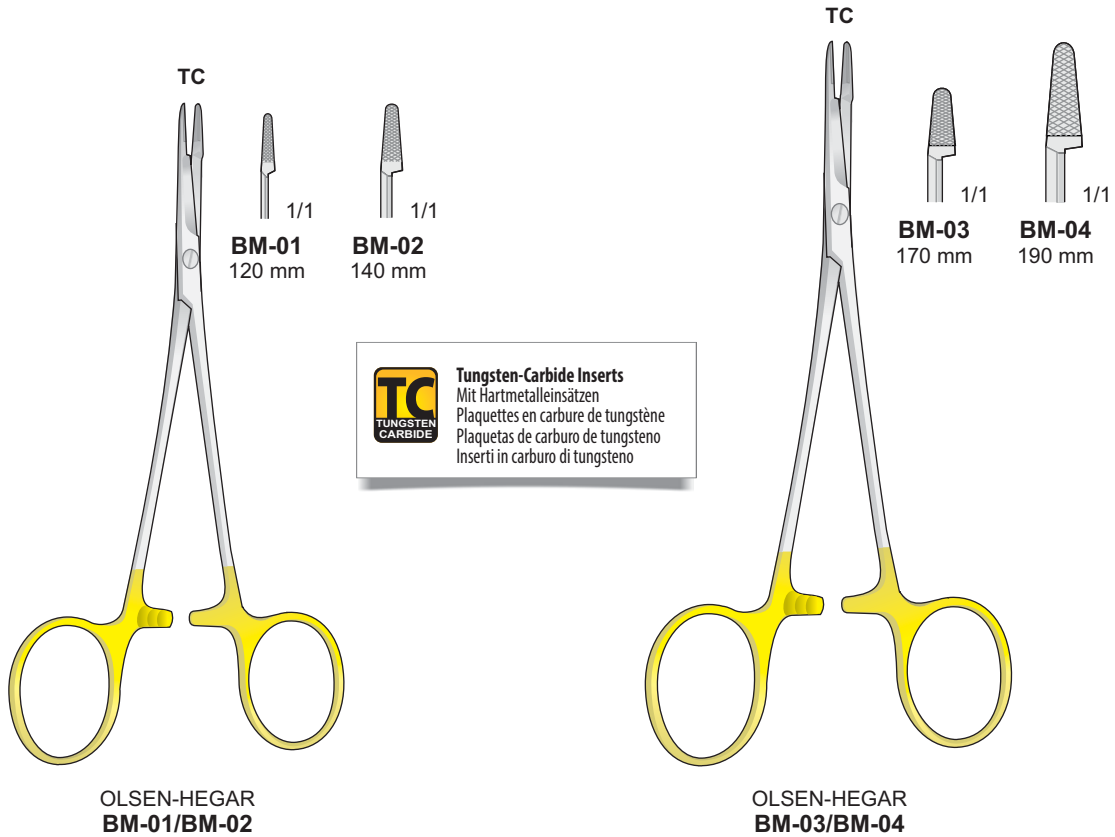

Portaghi con inserti al tungsteno - Needle Holders with tungsten-carbide inserts
 Nadelhalter mit Hartmetalleinlagen - Porte aiguilles avec plaquettes en carbure de tungstène
 Portaagujas con plaquitas de carburo de tungsteno

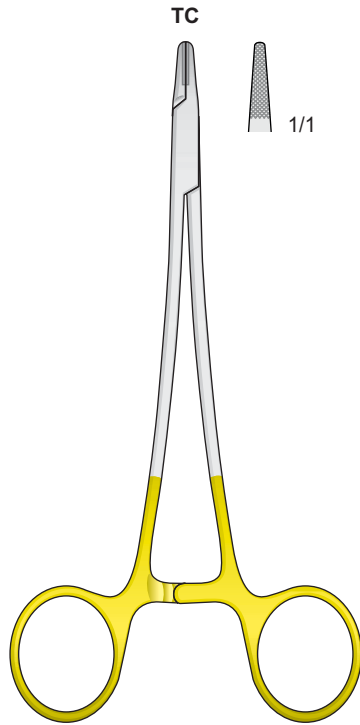

PH-79
145 mm

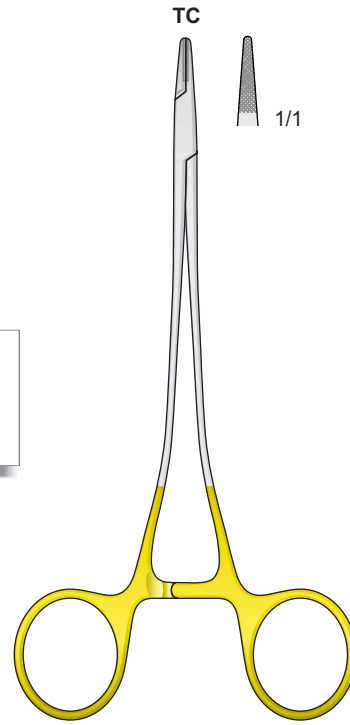

PH-85
150 mm

TC
TUNGSTEN
CARBIDE
Tungsten-Carbide Inserts
 Mit Hartmetalleinsätzen
 Plaquettes en carbure de tungstène
 Plaquetas de carburo de tungsteno
 Inserti in carburo di tungsteno

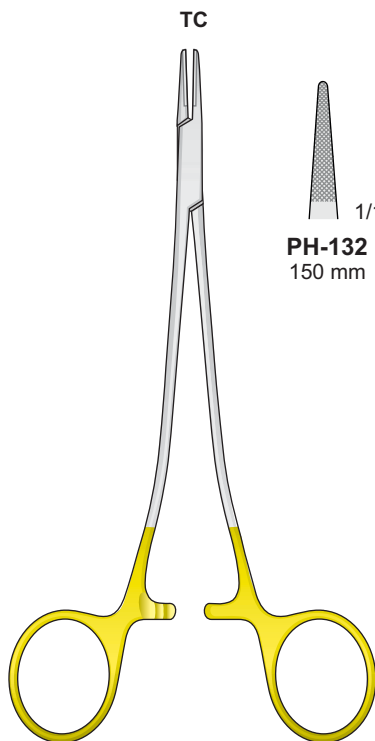

SAROT
PH-132/PH-134

PH-132
150 mm

PH-133
180 mm

PH-134
210 mm

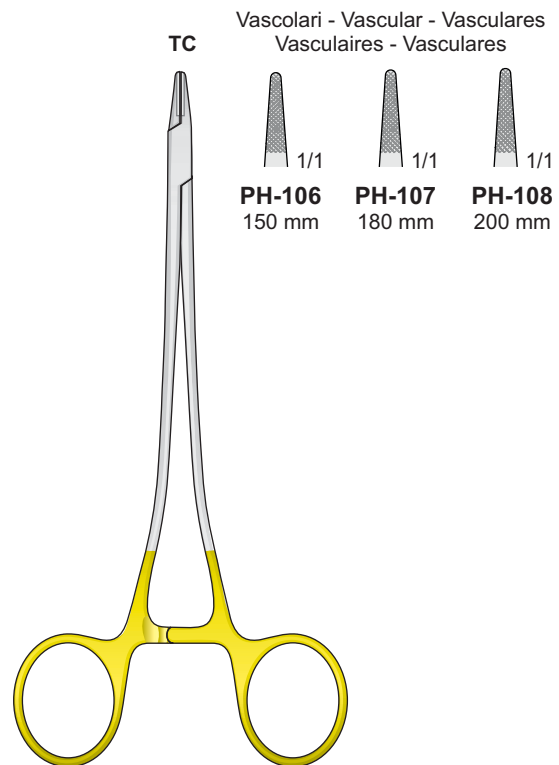

SWEDISH MOD.
PH-106/PH-108

Vascolari - Vascular - Vasculares
 Vasculaires - Vasculares

PH-106
150 mm

PH-107
180 mm

PH-108
200 mm

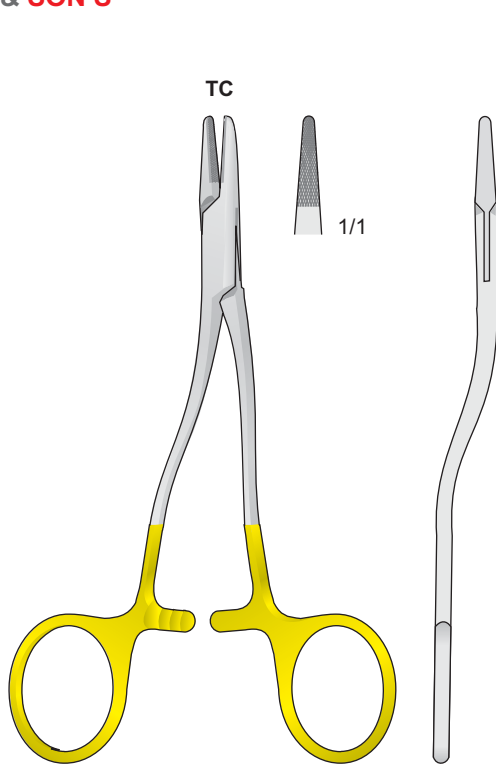

KILNER
PH-98
130 mm



MAYO-HEGAR-HEANEY
PH-95/PH-97

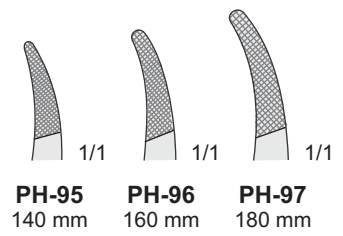

PH-95 140 mm
PH-96 160 mm
PH-97 180 mm

TC
TUNGSTEN
CARBIDE

Tungsten-Carbide Inserts
Mit Hartmetalleinsätzen
Plaquettes en carbure de tungstène
Plaquetas de carburo de tungsteno
Inserti in carburo di tungsteno

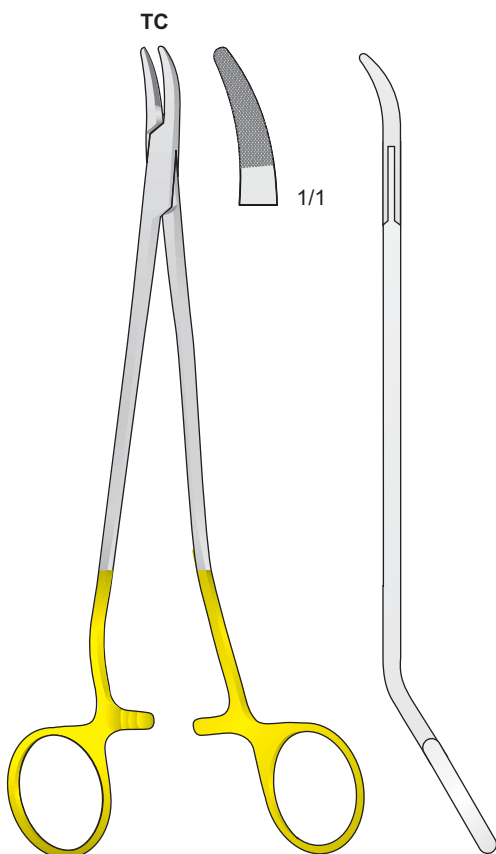

S-FORMING
PH-89
200 mm

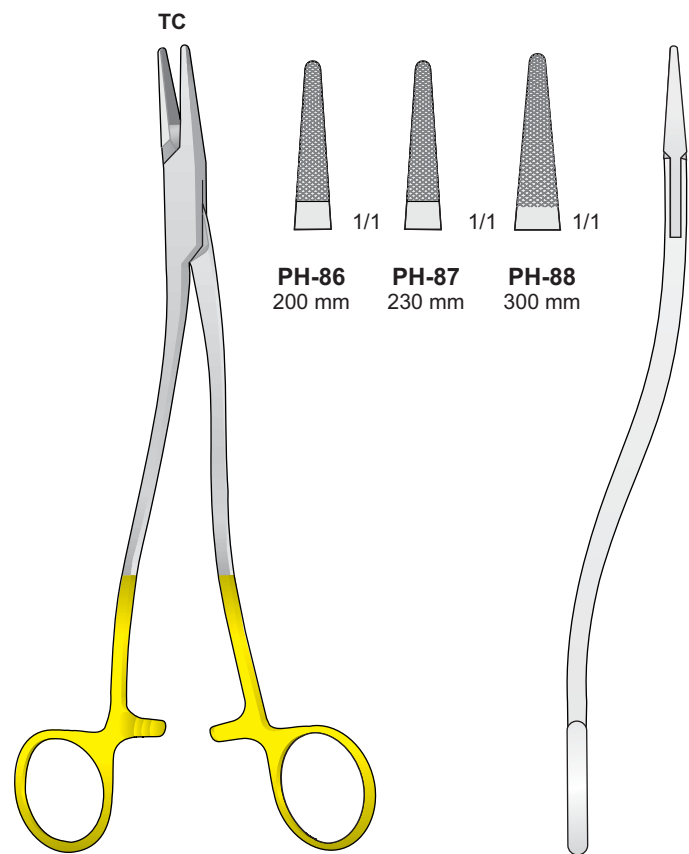

WERTHEIM
PH-86/PH-88

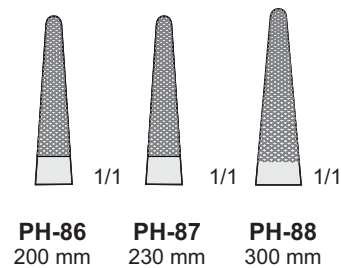

PH-86 200 mm
PH-87 230 mm
PH-88 300 mm

07

Portaghi con inserti al tungsteno - Needle Holders with tungsten-carbide inserts
 Nadelhalter mit Hartmetalleinlagen - Porte aiguilles avec plaquettes en carbure de tungstène
 Portaagujas con plaquitas de carburo de tungsteno

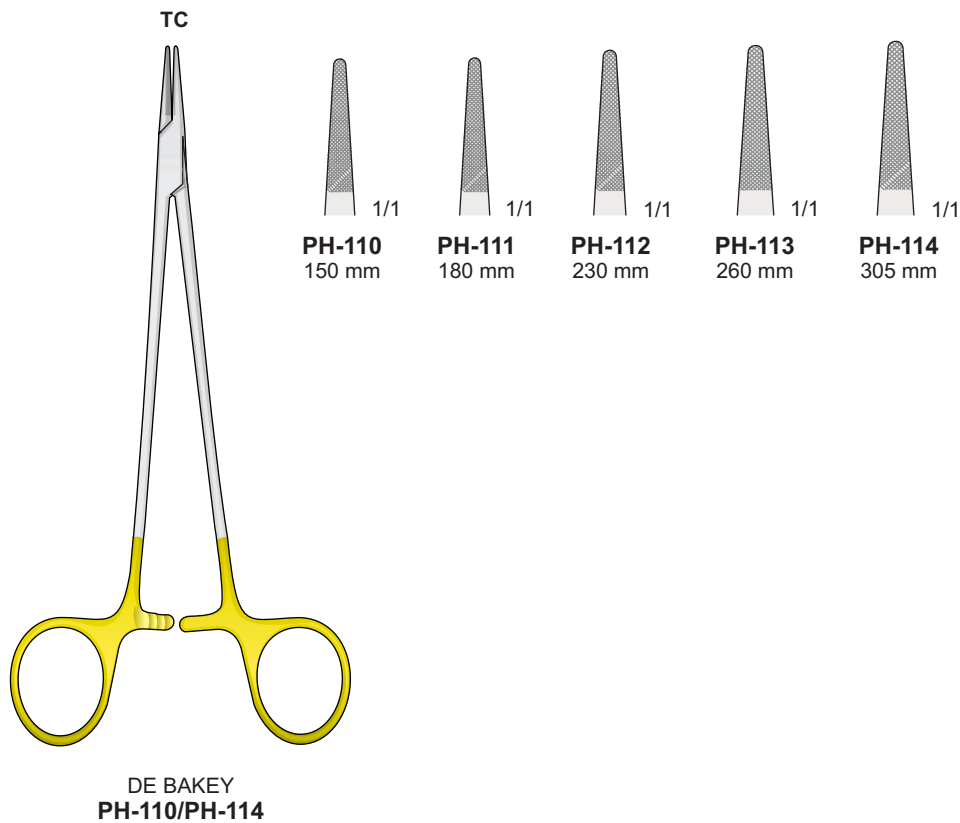
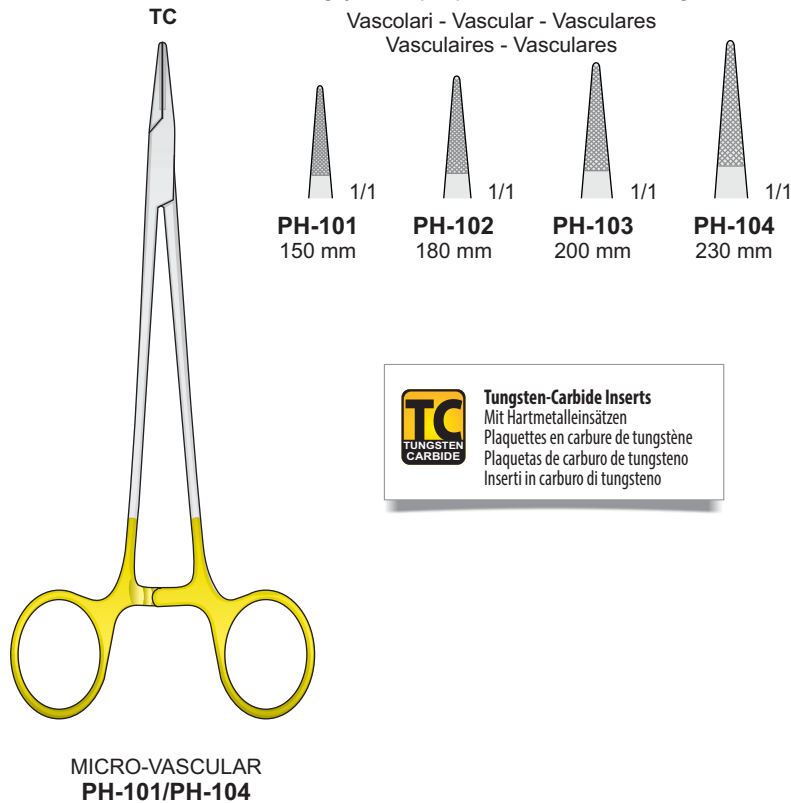



Tungsten-Carbide Inserts
 Mit Hartmetalleinsätzen
 Plaquettes en carbure de tungstène
 Plaquetas de carburo de tungsteno
 Inserti in carburo di tungsteno

Portaghi con inserti al tungsteno - Needle Holders with tungsten-carbide inserts
 Nadelhalter mit Hartmetalleinlagen - Porte aiguilles avec plaquettes en carbure de tungstène
 Portaagujas con plaquetas de carburo de tungsteno

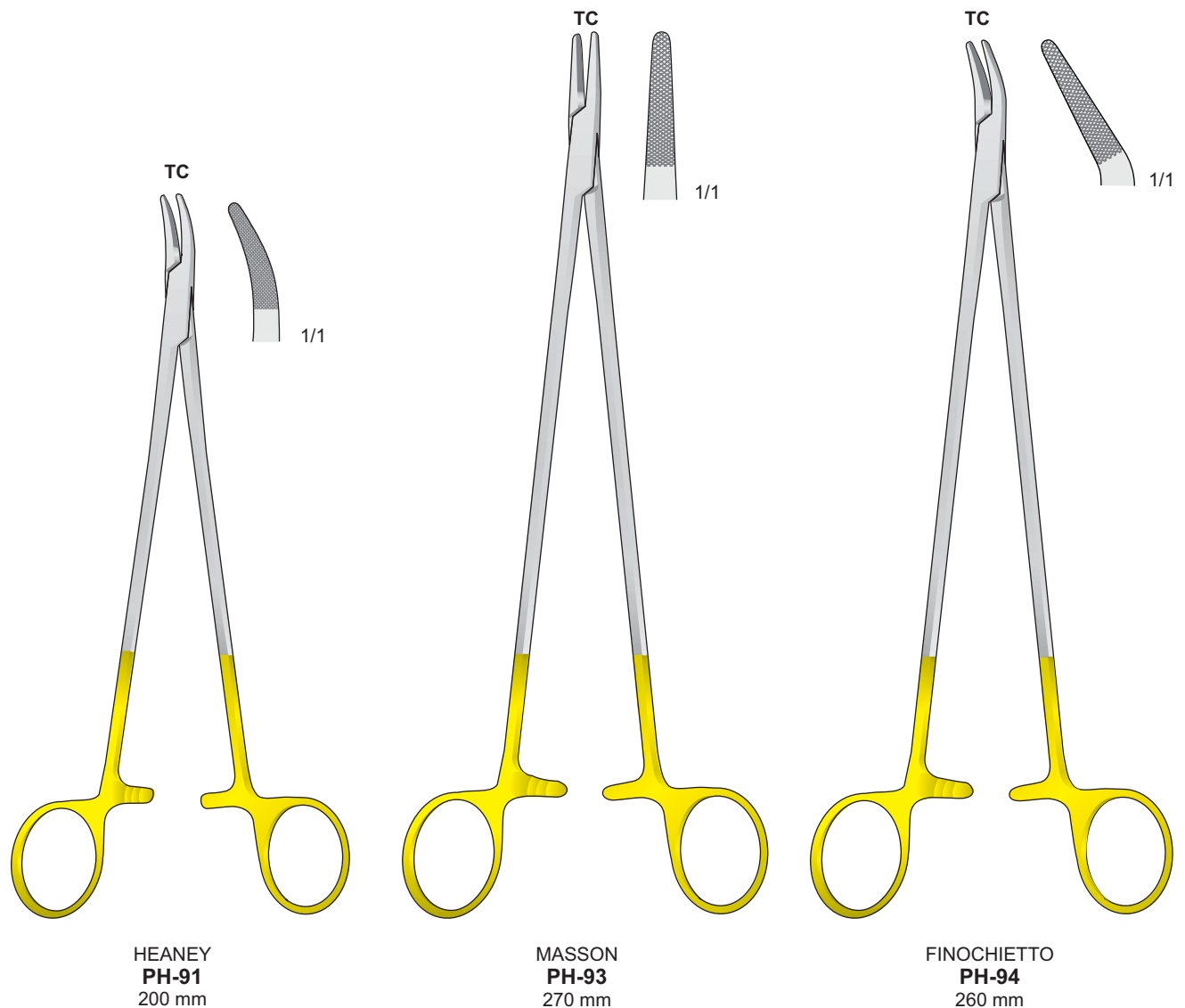

Portaghi con inserti al tungsteno - Needle Holders with tungsten-carbide inserts
 Nadelhalter mit Hartmetalleinlagen - Porte aiguilles avec plaquettes en carbure de tungstène
 Portaagujas con plaquitas de carburo de tungsteno

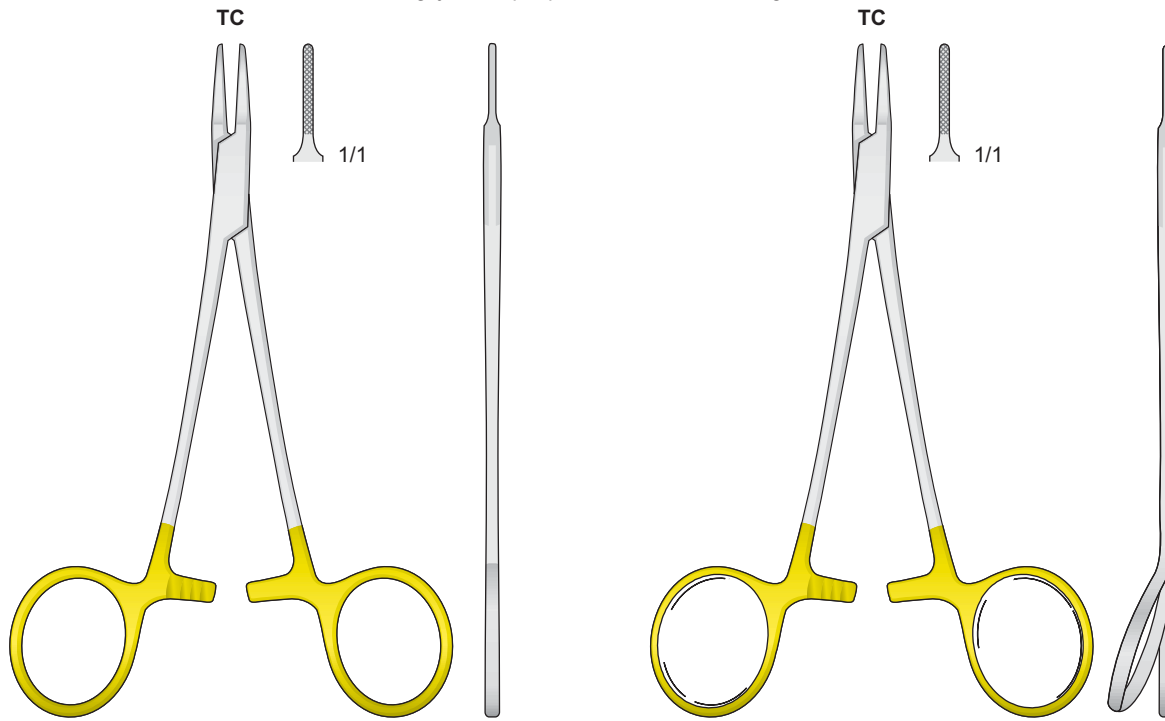

MICRO-RYDER
PH-83
 140 mm

PH-84
 140 mm

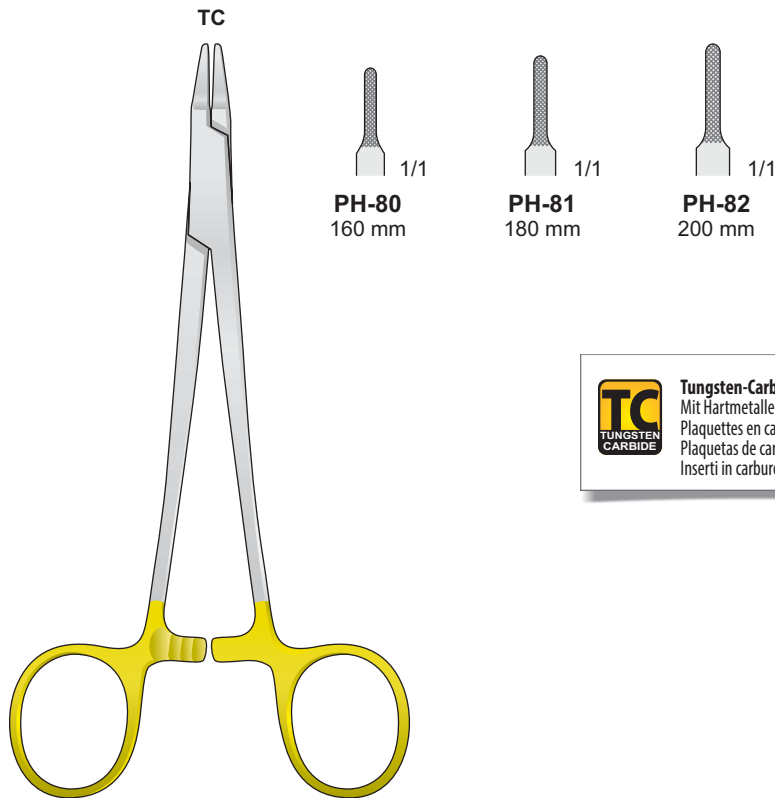

RYDER
PH-80/PH-82

TC
 TUNGSTEN
 CARBIDE

Tungsten-Carbide Inserts
 Mit Hartmetalleinsätzen
 Plaquettes en carbure de tungstène
 Plaquetas de carburo de tungsteno
 Inserti in carburo di tungsteno

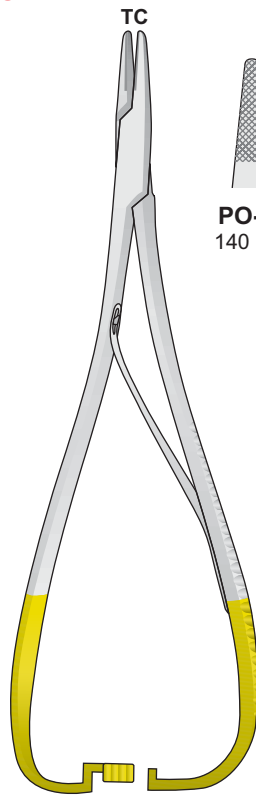

MATHIEU
PO-50/PO-52

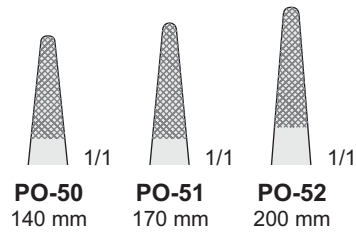

TC
TUNGSTEN
CARBIDE

Tungsten-Carbide Inserts
Mit Hartmetalleinsätzen
Plaquettes en carbure de tungstène
Plaquetas de carburo de tungsteno
Inserti in carburo di tungsteno

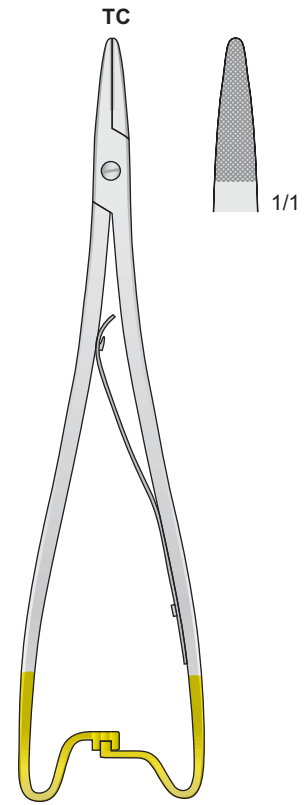

MATHIEU
PO-66

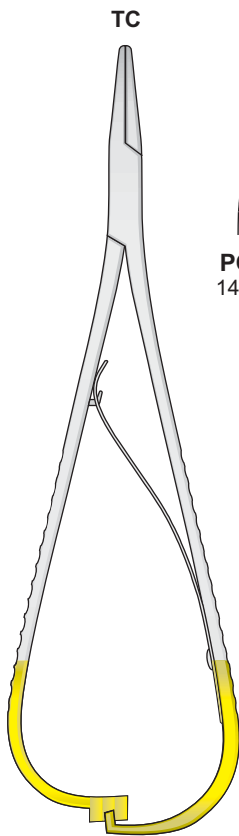
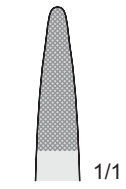

MATHIEU
PO-82/PO-92

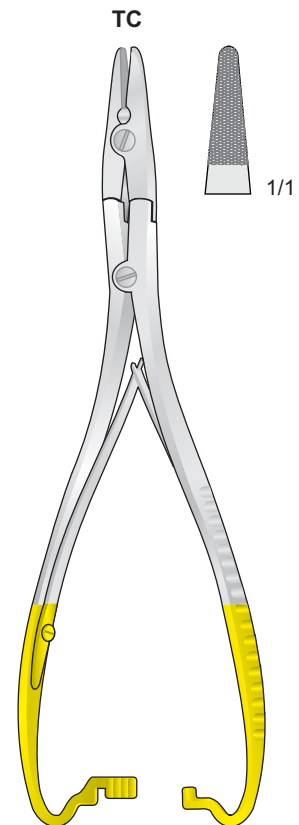
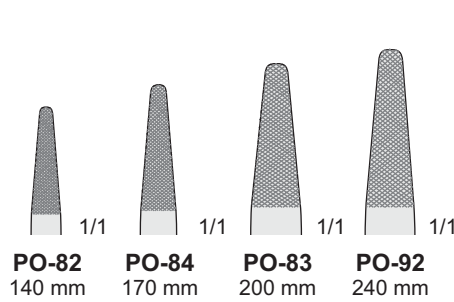

PO-110
200 mm

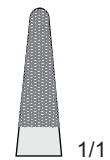

TC
TUNGSTEN
CARBIDE

Tungsten-Carbide Inserts
Mit Hartmetalleinsätzen
Plaquettes en carbure de tungstène
Plaquetas de carburo de tungsteno
Inserti in carburo di tungsteno

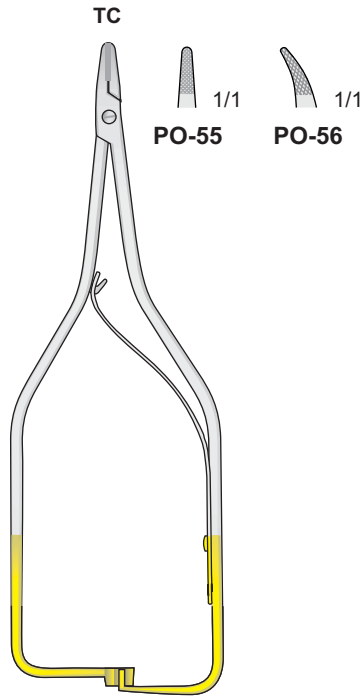

BOYNTON
PO-55/PO-56
120 mm

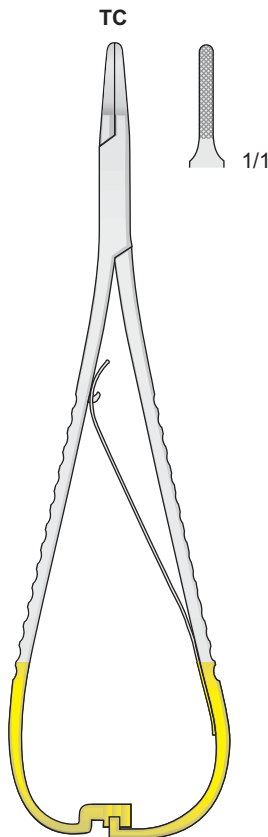

LICHTENBERG
PO-86
175 mm

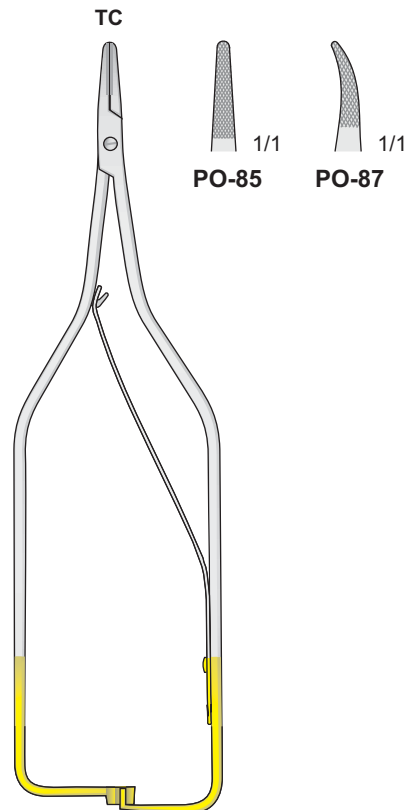

ARRUGA
PO-85/PO-87
160 mm

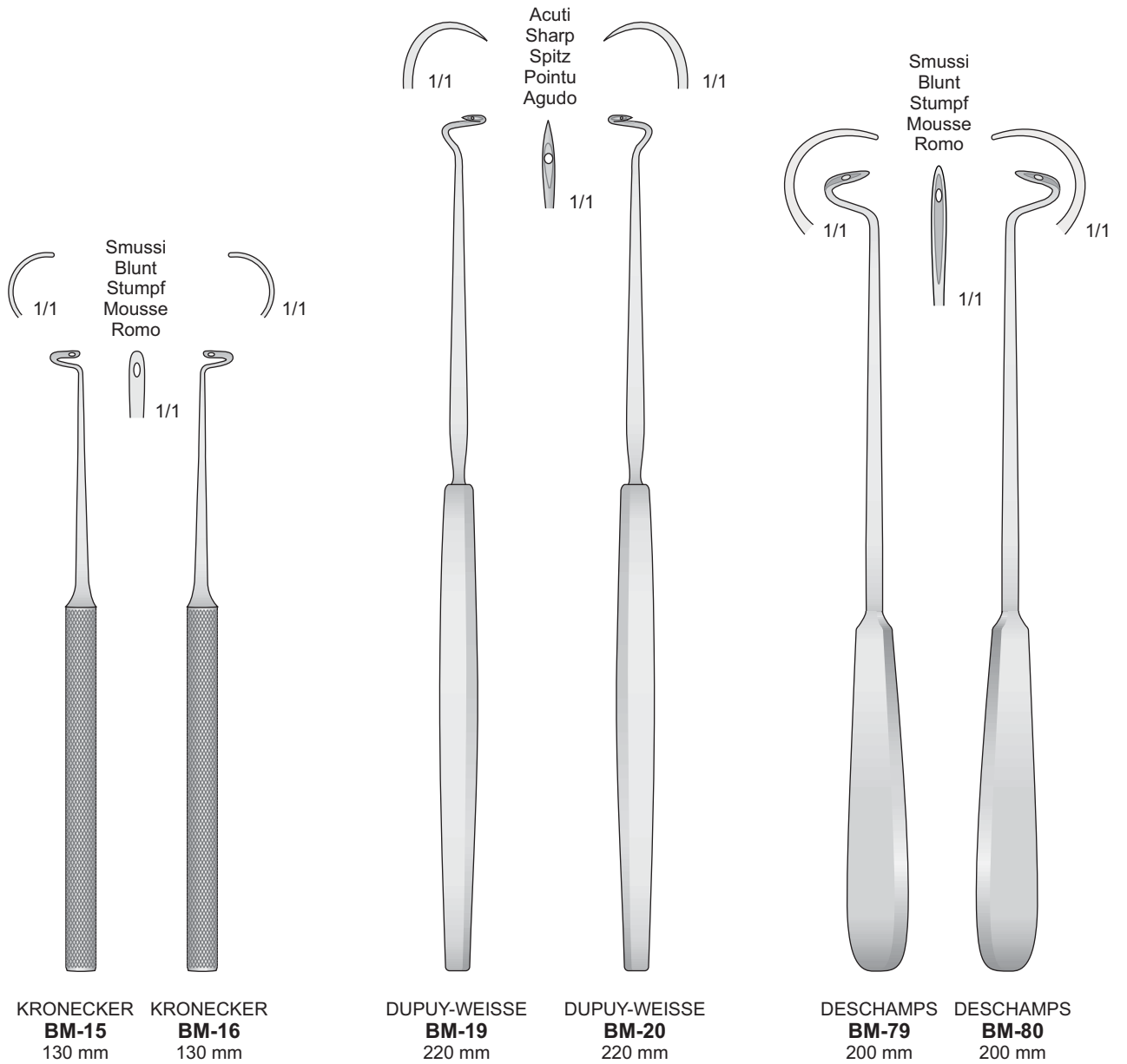

07

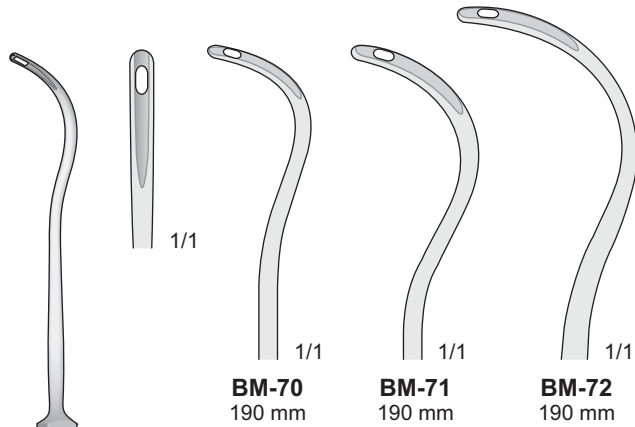

BM-70
190 mm

BM-71
190 mm

BM-72
190 mm

Malleabile
Flexible
Biegsam
Souple
Maleable

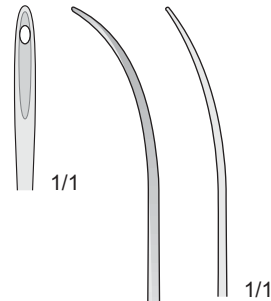

KOCHER
BM-70/BM-72
190 mm

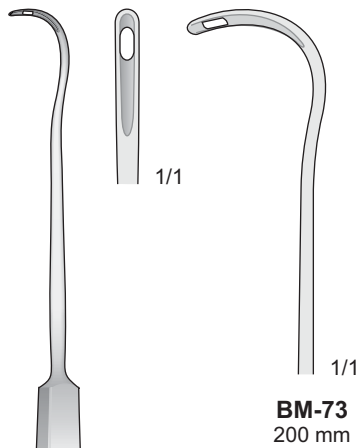

BM-73
200 mm

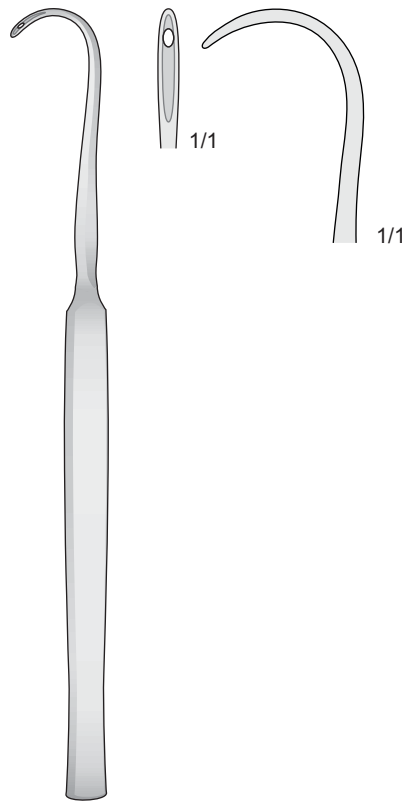

COOPER
BM-29
190 mm

COOPER
BM-73
200 mm

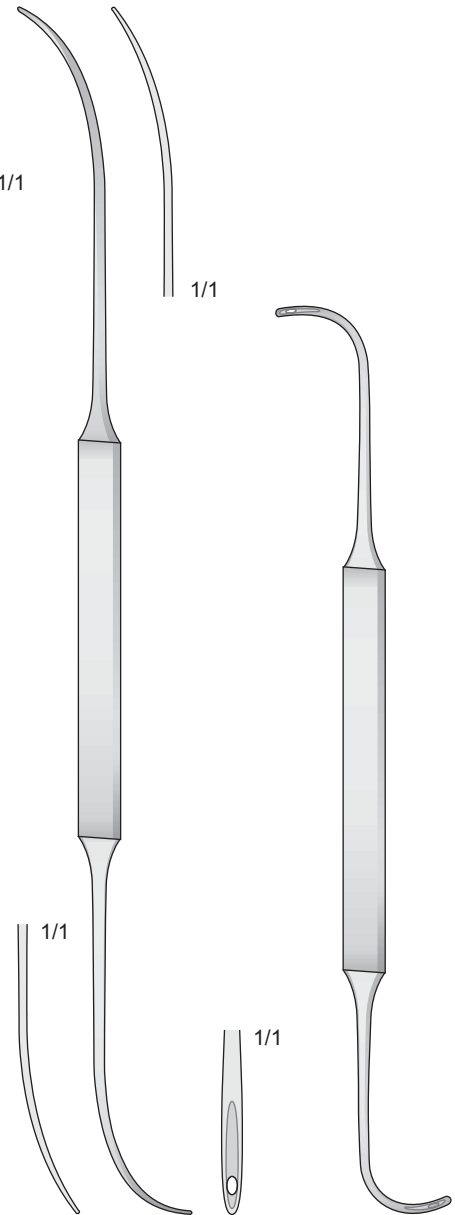

SCHMIEDEN-DICK
BM-17
320 mm

SCHMIEDEN
BM-18
210 mm

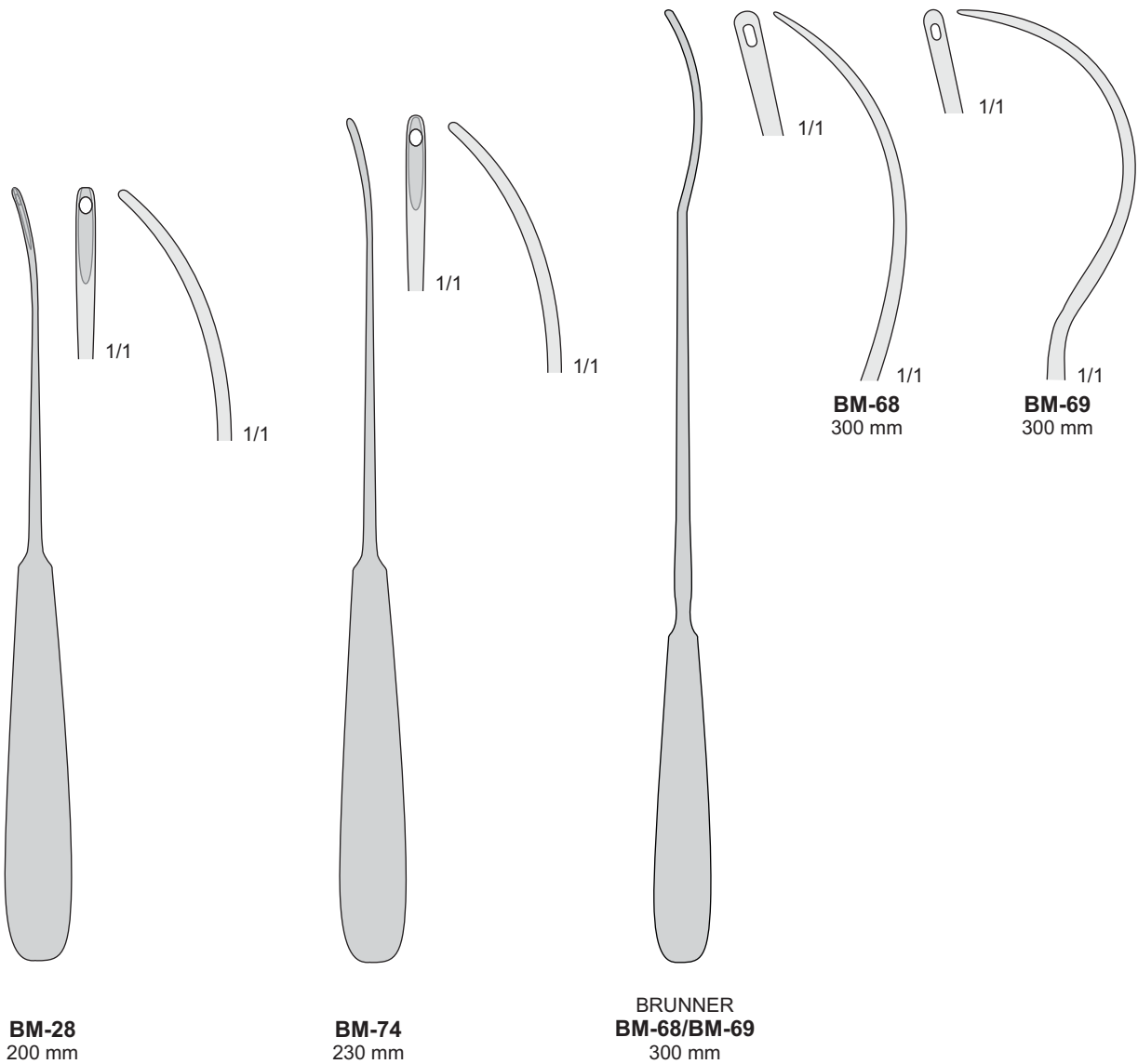

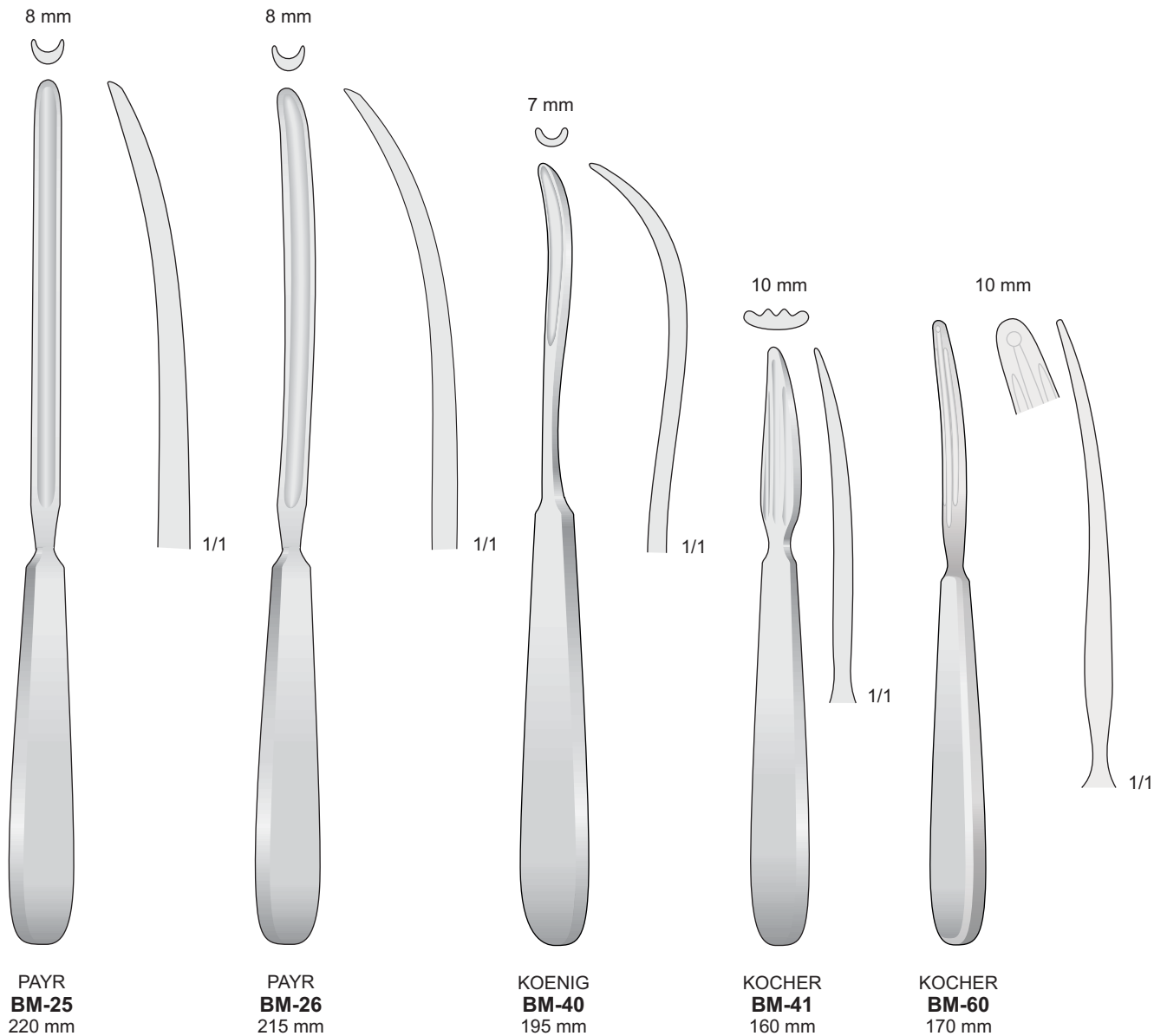

1/1

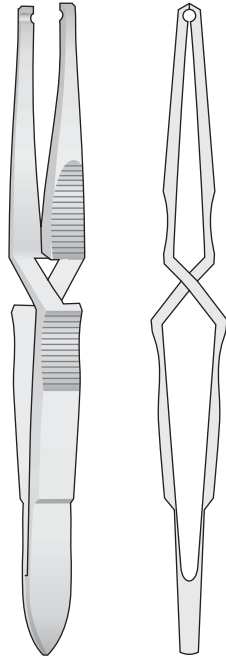

HEGENBARTH
BD-52
125 mm

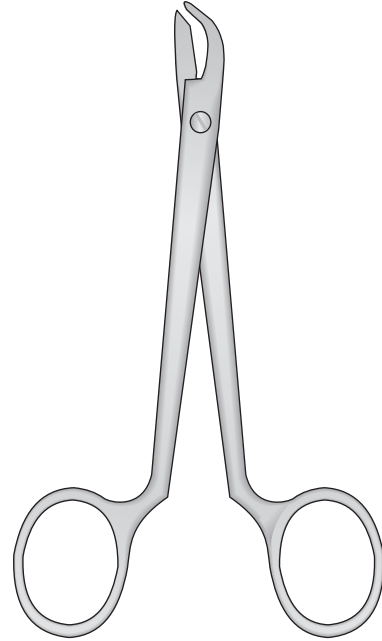

COLLIN
BF-65
135 mm

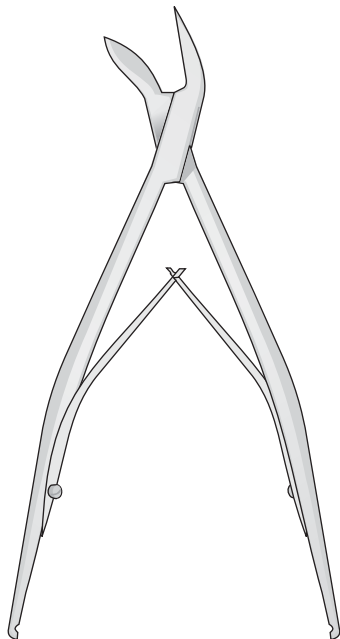

MICHEL
BF-68
130 mm

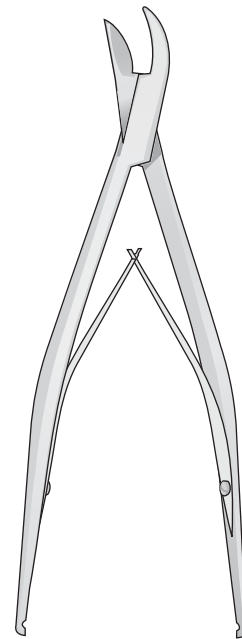

MICHEL
BF-69
120 mm

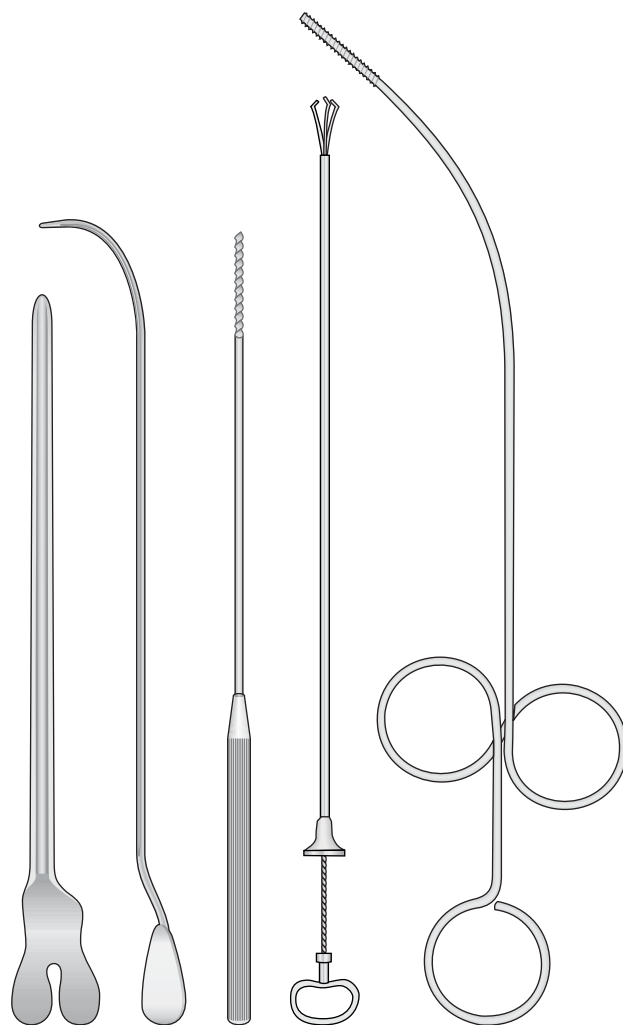

08 |

Probes | Cotton Applicator
Sonden | Watteträger
Sondes | Applicateur de coton
Sondas | Porta-algodón

Hohlsonde

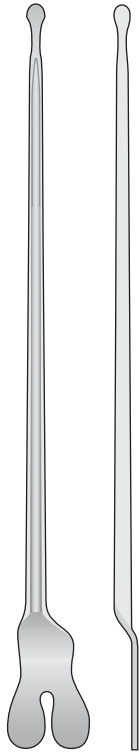

PF-54 145 mm
PF-55 160 mm
PF-19 180 mm
PF-56 200 mm

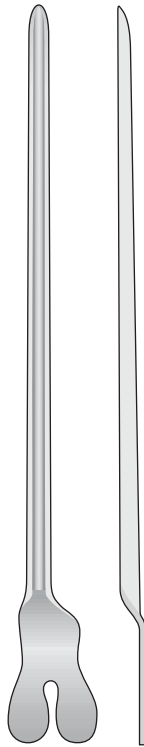

PF-53 130 mm
PF-57 145 mm
PF-58 160 mm
PF-59 180 mm
PF-18 200 mm

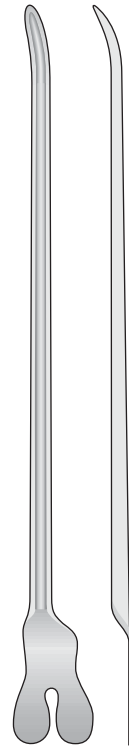

DOYEN
PF-24
145 mm

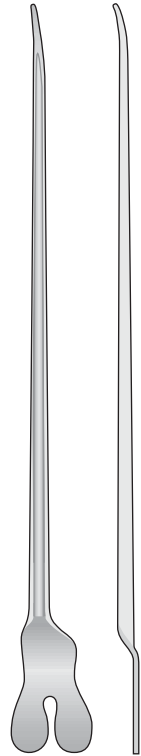

NELATON
PF-17
160 mm

Sonde per fistole - Fistula probes - Fistelnsonden - Sondes pour fistules - Sondas para fistulas



LOCHART
PF-80
170 mm

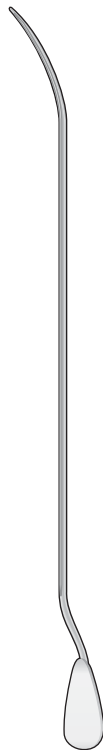

LOCHART
PF-81
170 mm



LOCHART
PF-82
170 mm

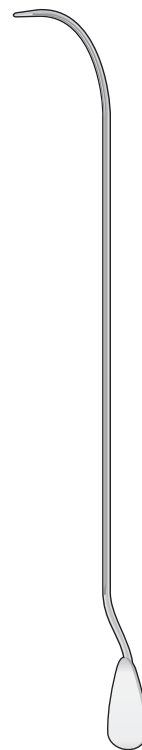

LOCHART
PF-83
170 mm

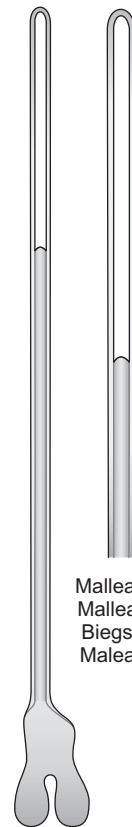

LOCHART
PF-85
190 mm

1/1
Malleabile
Malleable
Biegsam
Maleable

Ø 1 mm



Ø 1,5 mm



Ø 2 mm



Ø 2 mm



Ø 1,5 mm



Ø 1,0 mm



PF-20 145 mm
PF-21 160 mm

PF-32 130 mm
PF-22 145 mm
PF-25 160 mm
PF-26 200 mm

PF-27 145 mm
PF-23 160 mm
PF-28 200 mm
PF-44 250 mm

PF-36 130 mm
PF-15 145 mm
PF-29 160 mm
PF-38 200 mm

PF-7
145 mm

STACKE
PF-14
110 mm

BOWMAN
PF-30 00/0
PF-31 1/2
PF-33 3/4
PF-34 5/6
PF-35 7/8
PF-37 6/7

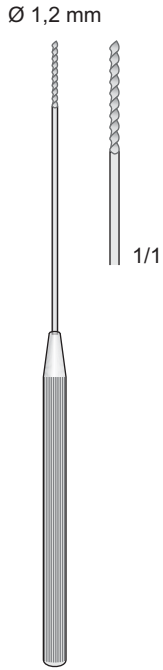

UNIVERSAL
PF-48 120 mm
PF-40 140 mm
PF-50 160 mm

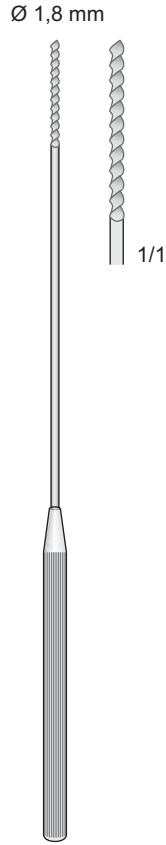

UNIVERSAL
PF-62 120 mm
PF-63 140 mm
PF-64 160 mm
PF-41 180 mm

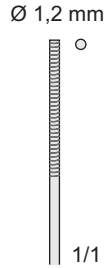

PF-43 140 mm
PF-51 160 mm
 Rotondo
 Round
 Rund
 Rondes
 Redondas

MOD. MARTIN
PF-43/PF-52

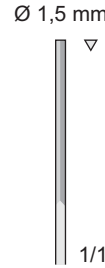

PF-46 140 mm
PF-52 160 mm
 Triangolare
 Triangular
 Dreikant
 Triangulaires
 Triangulares

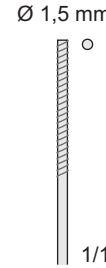

PF-49 180 mm
 Rotondo
 Round
 Rund
 Rondes
 Redondas

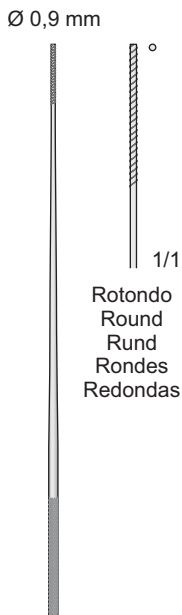

FARRELL
PF-10 120 mm

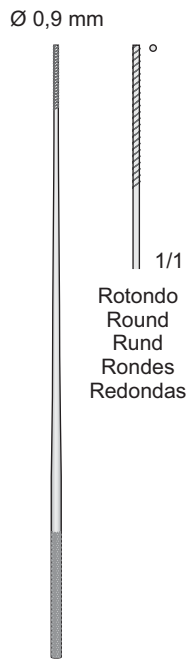

FARRELL
PF-13 140 mm
PF-66 160 mm
PF-67 180 mm

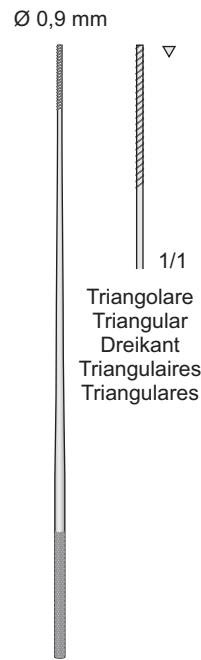

FARRELL
PF-68 140 mm
PF-69 160 mm

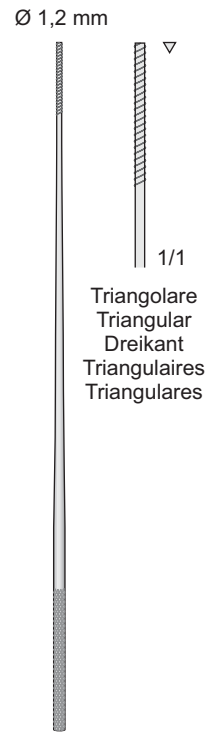

FARRELL
PF-39 180 mm

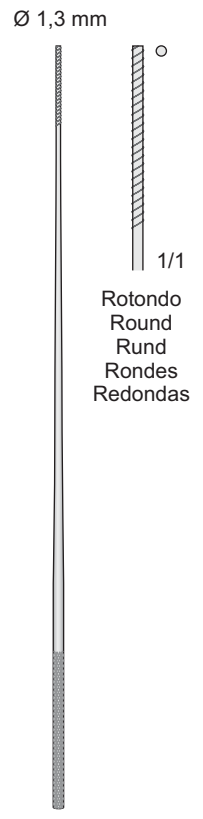

FARRELL
PF-42 230 mm

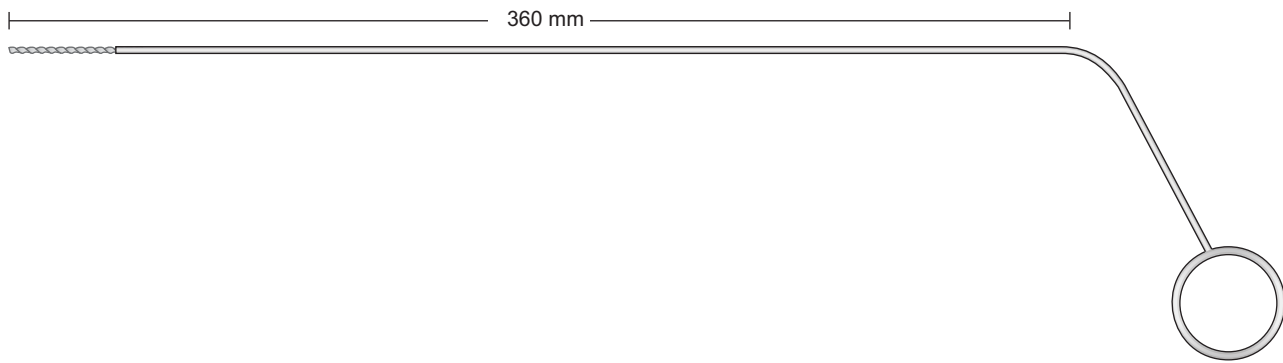

PF-88
400 mm

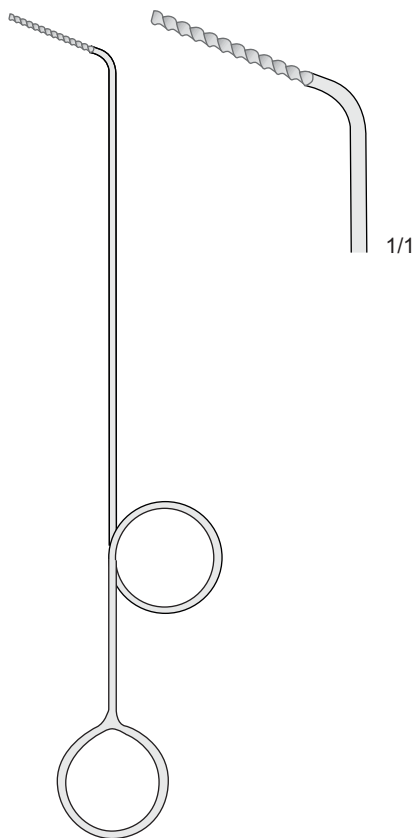

HARTMANN
PF-73 - Ø 2,3 mm

220 mm

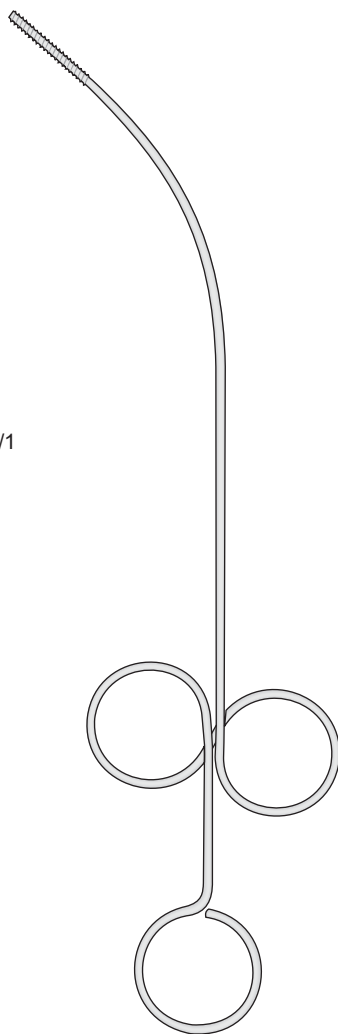

FEIN
PF-65

250 mm

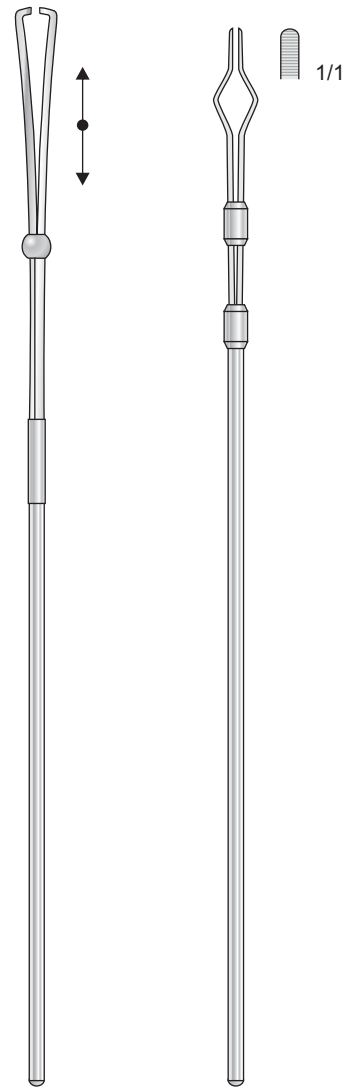

HEILDEBERG
PF-60

180 mm

HEILDEBERG
PF-61

170 mm

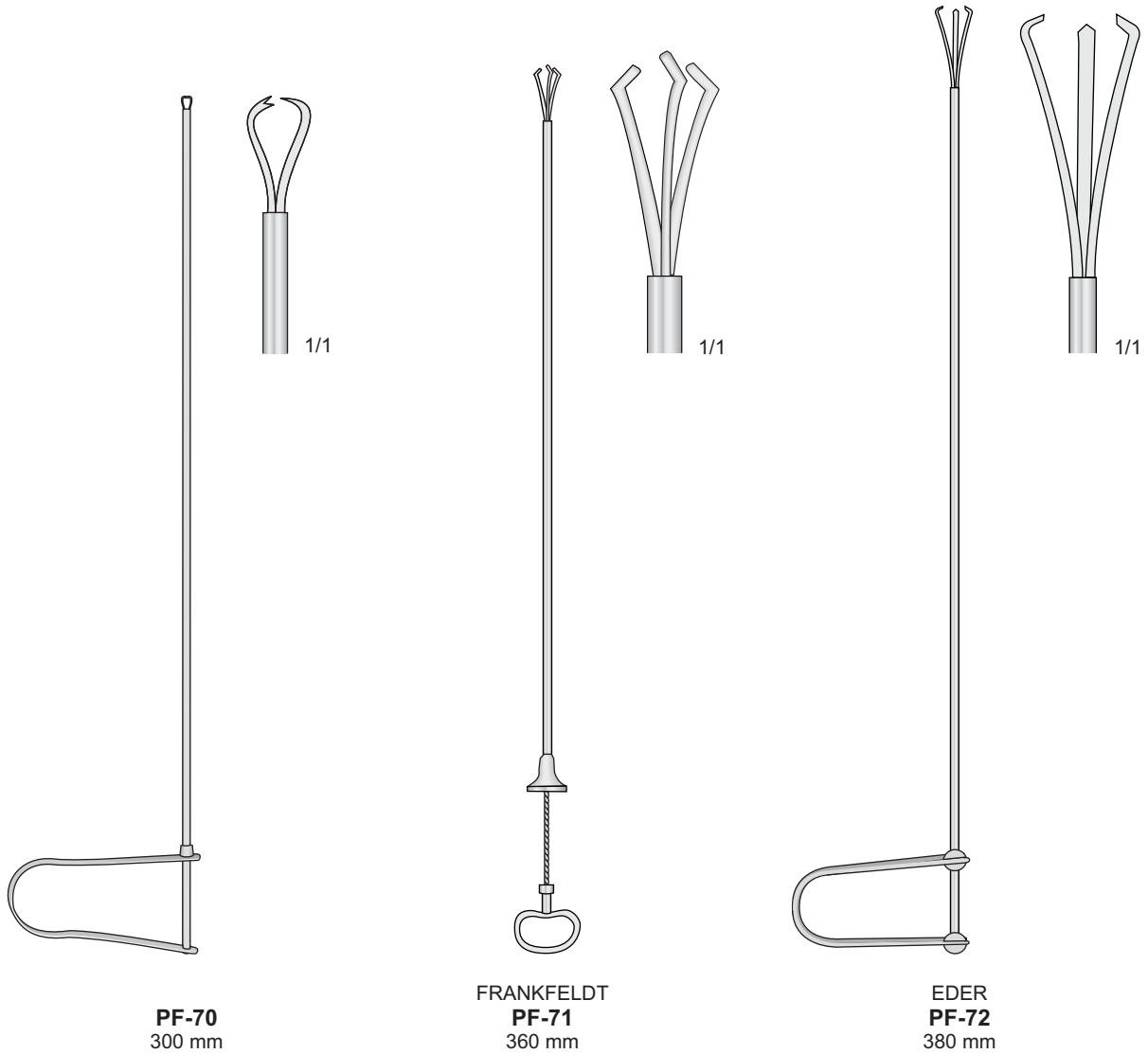

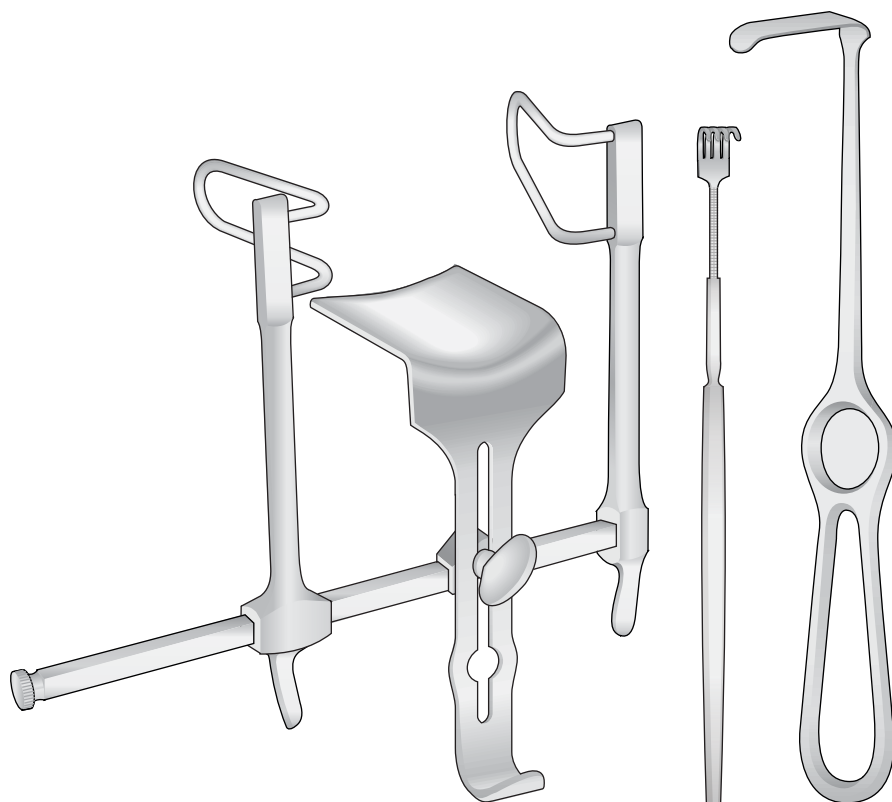

09 |

Retractors
Retraktoren
Écarteurs
Separadores
Divaricatori

Uncini cutanei - Cutaneous hook - Hauthäkchen - Erignes cutanées - Ganchos cutâneos

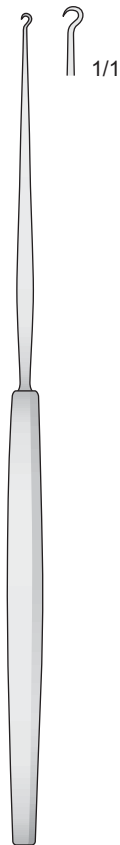

GILLIES
BT-15
180 mm

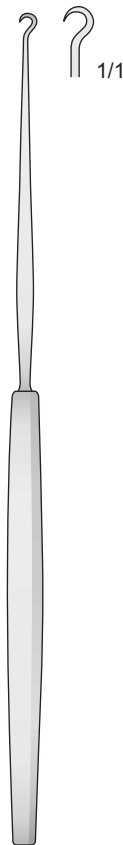

GILLIES
BT-16
180 mm

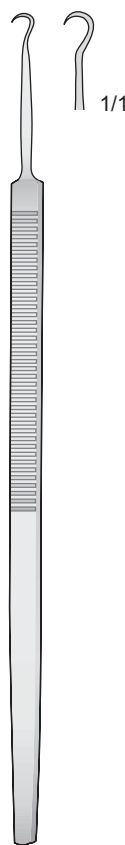

BT-207
160 mm

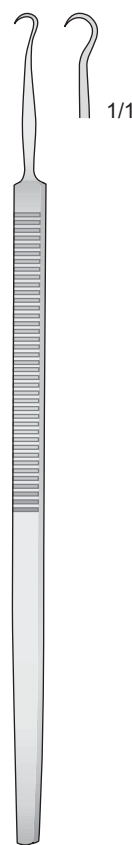

BT-208
160 mm

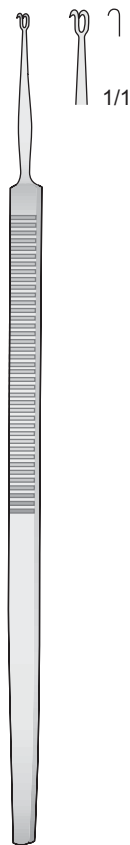

GUTHRIE
BT-203
160 mm

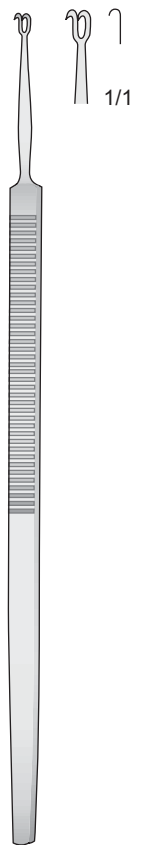

GUTHRIE
BT-204
160 mm

09

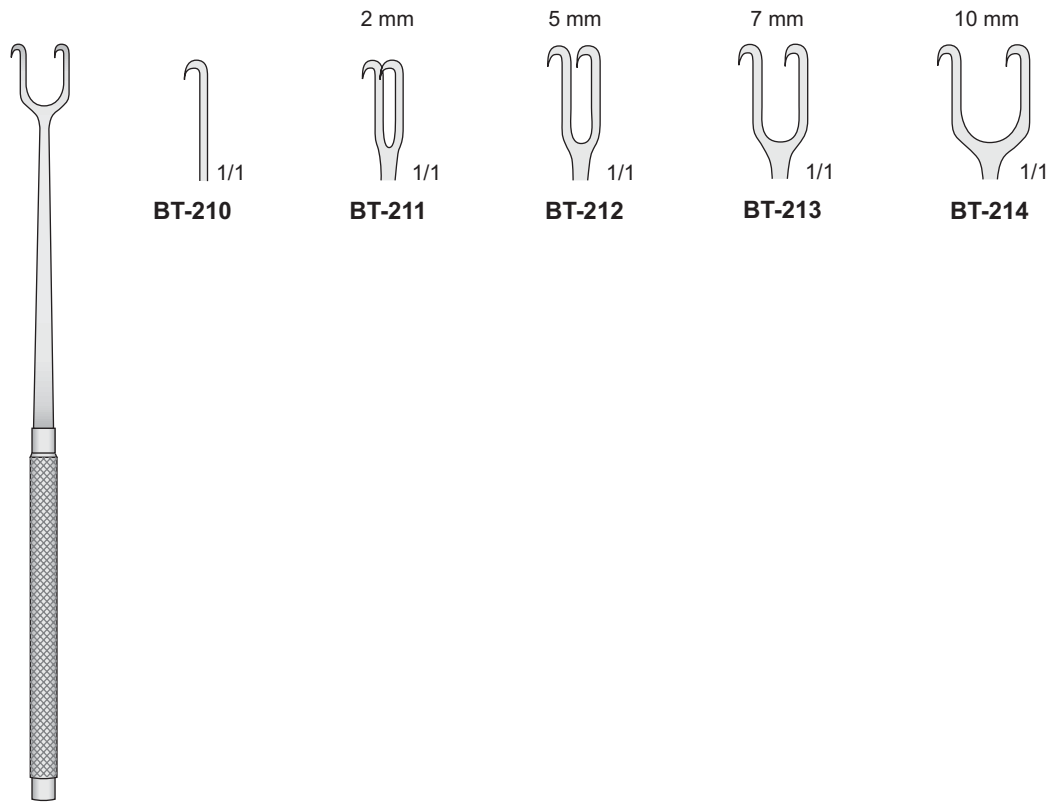

JOSEPH
BT-210/BT-214
160 mm

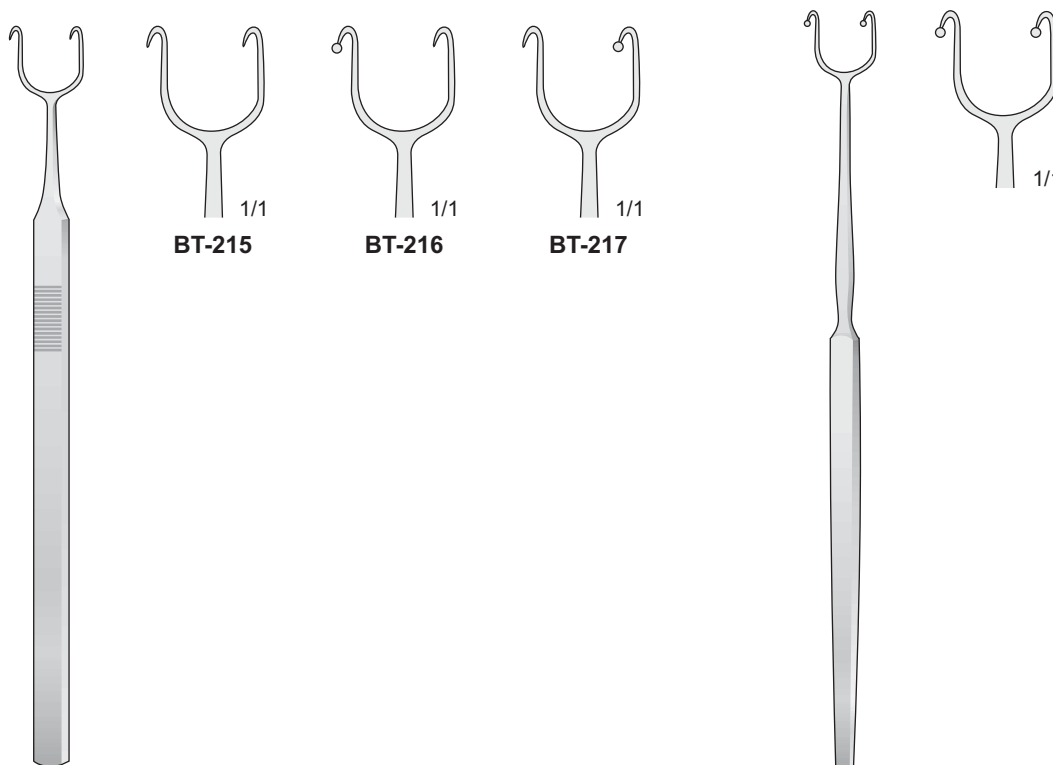

COTTLE
BT-215/BT-217
150 mm

FOMON
BT-218
160 mm

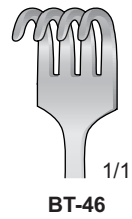
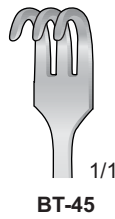
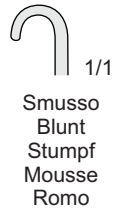
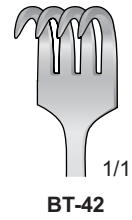
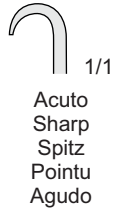

BT-40/BT-46
160 mm

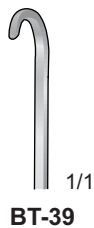
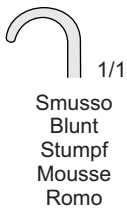
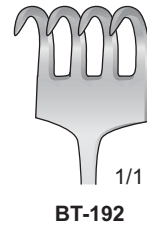
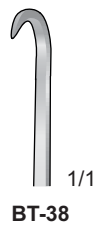
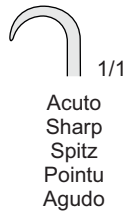

BT-38/BT-195
160 mm

Divaricatori delicati flessibili-acuti
 Feine wundhaken flexibel-spitz
 Delicate retractors flexible-sharp
 Separadores finos flexibles-agudas

Divaricatori delicati flessibili-smussi
 Feine wundhaken flexibel-stumpf
 Delicate retractors flexible-blunt
 Separadores finos flexibles-romas

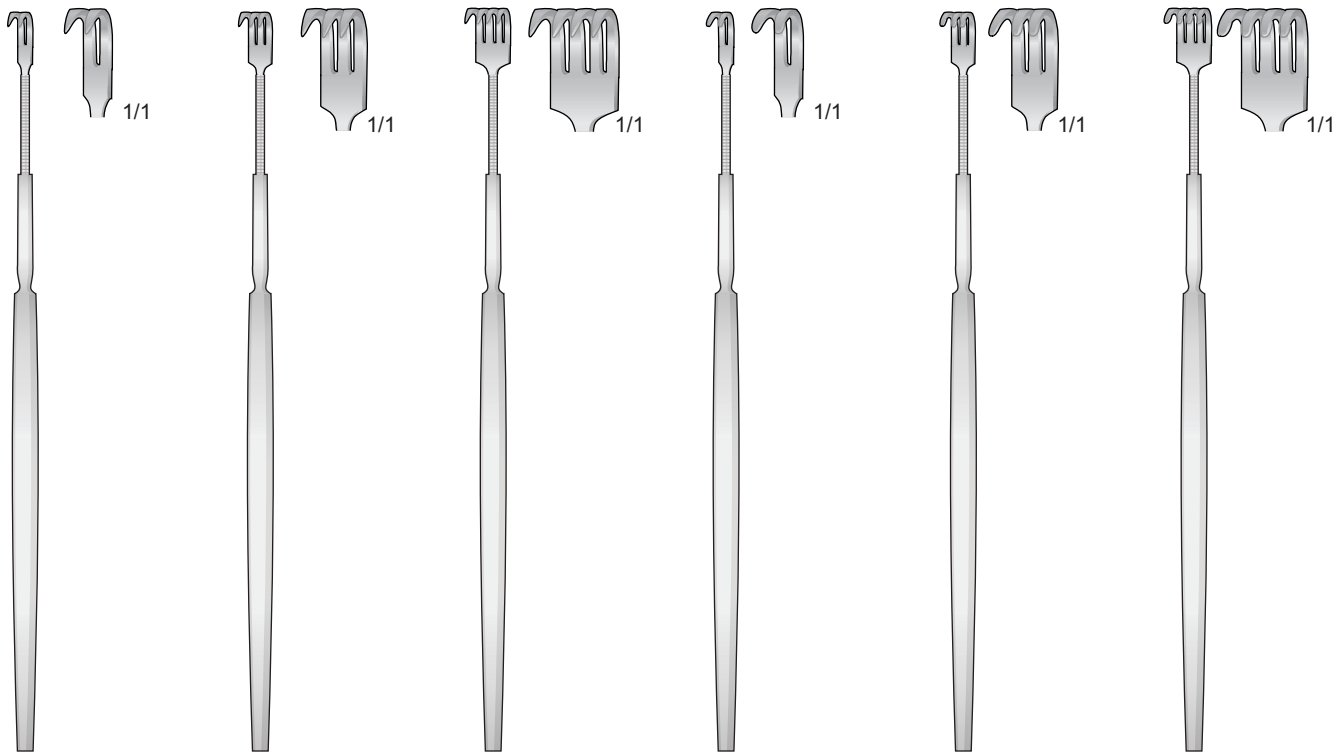

BT-50
150 mm

BT-51
150 mm

BT-52
150 mm

BT-54
150 mm

BT-55
150 mm

BT-56
150 mm

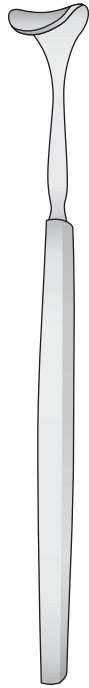

DESMARRES
BT-70/BT-79
140 mm



BT-70
10 mm

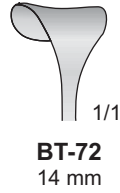

BT-72
14 mm

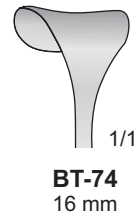

BT-74
16 mm

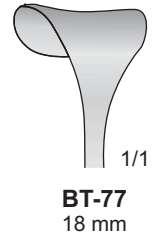

BT-77
18 mm



BT-71
12 mm



BT-73
14 mm



BT-75
16 mm

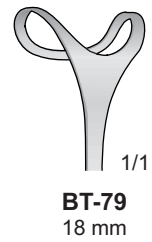

BT-79
18 mm

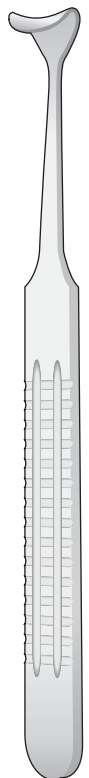

DESMARRES
BT-28
160 mm

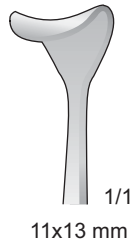

BT-28
11x13 mm

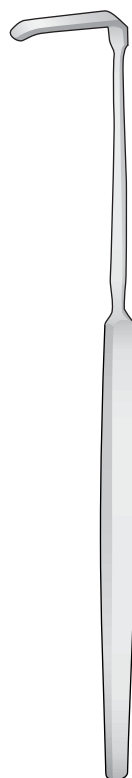

SENN GREEN
BT-48/BT-49
160 mm



BT-48
10 x 6 mm



BT-49
20 x 6 mm



LAHEY
BT-109
195 mm

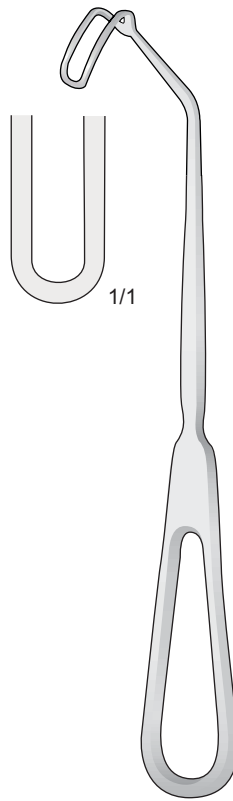

CUSHING
BT-29
200 mm

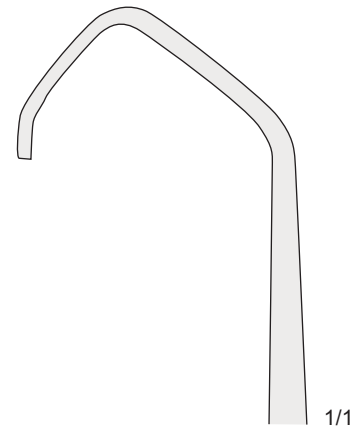

1/1

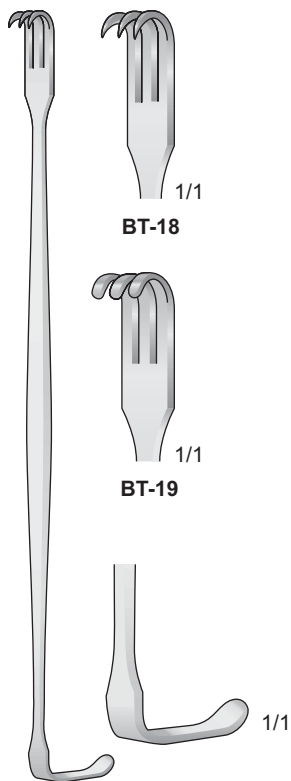

BT-18

BT-19

SENN-MILLER
BT-18/BT-19
160 mm

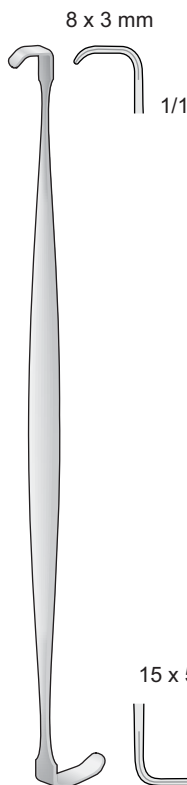

8 x 3 mm

1/1

RAGNELL
BT-27
140 mm

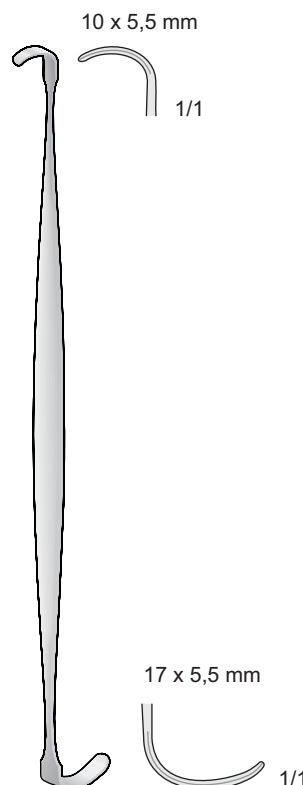

10 x 5,5 mm

1/1

17 x 5,5 mm

1/1

RAGNELL-DAVIS
BT-26
140 mm

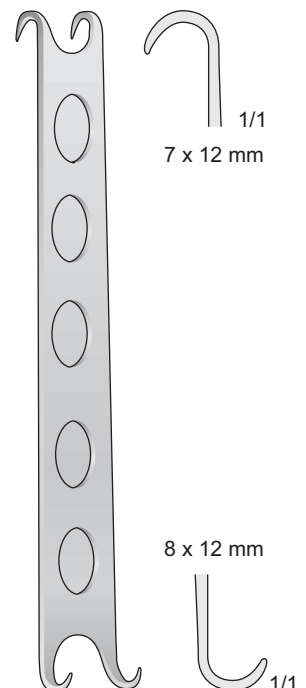

7 x 12 mm
1/1

8 x 12 mm

1/1

CONVERSE
BT-22
120 mm

Dritto



LOVE
DO-56
210 mm

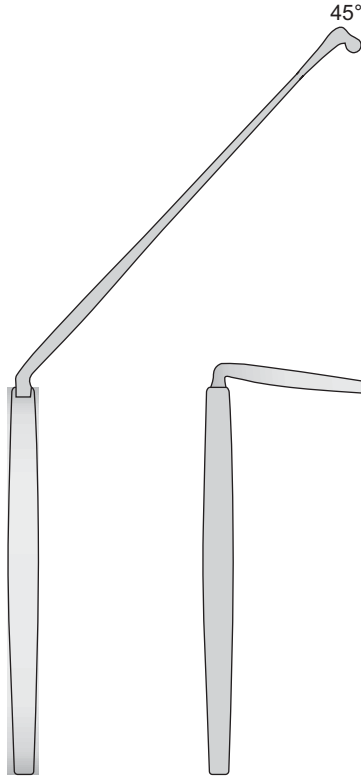

LOVE
DO-57

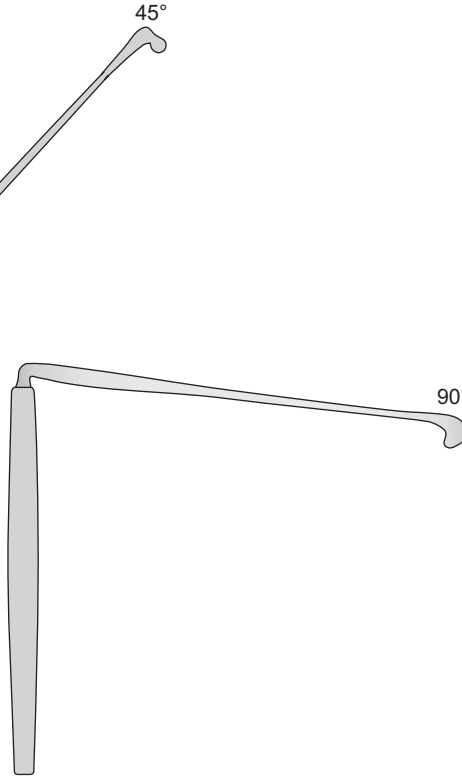

LOVE
DO-58



LOVE
DO-174
210 mm

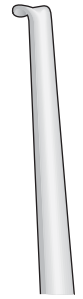

1/1

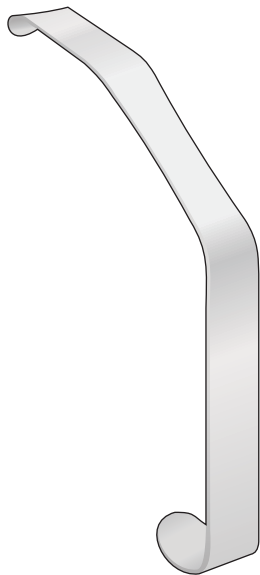

LOVE
DO-213 - 18 mm
DO-214 - 20 mm
DO-215 - 22 mm
150 mm



CUSHING
BT-296/BT-297
190 mm



BT-296
1/1



BT-297
1/1



CUSHING
BT-298/BT-299
280 mm



BT-298
1/1



BT-299
1/1



LANGE
KO-60
220 mm



1/1

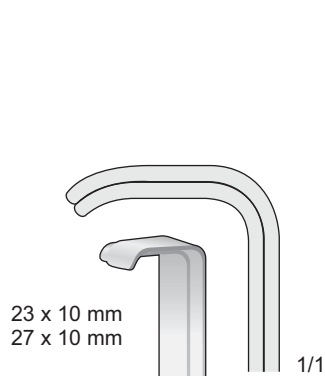

23 x 10 mm
27 x 10 mm

1/1

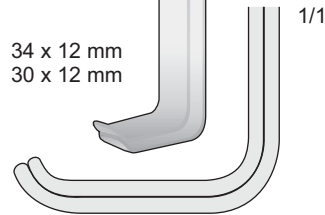

34 x 12 mm
30 x 12 mm

1/1

FARABEU
BT-20
120 mm

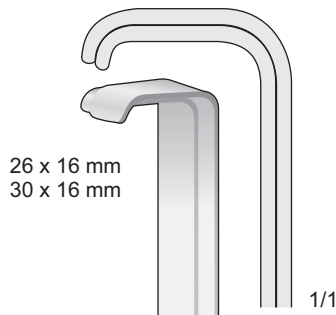

26 x 16 mm
30 x 16 mm

1/1

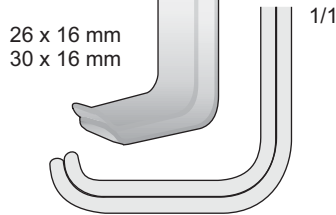

26 x 16 mm
30 x 16 mm

1/1

FARABEU
BT-25
150 mm

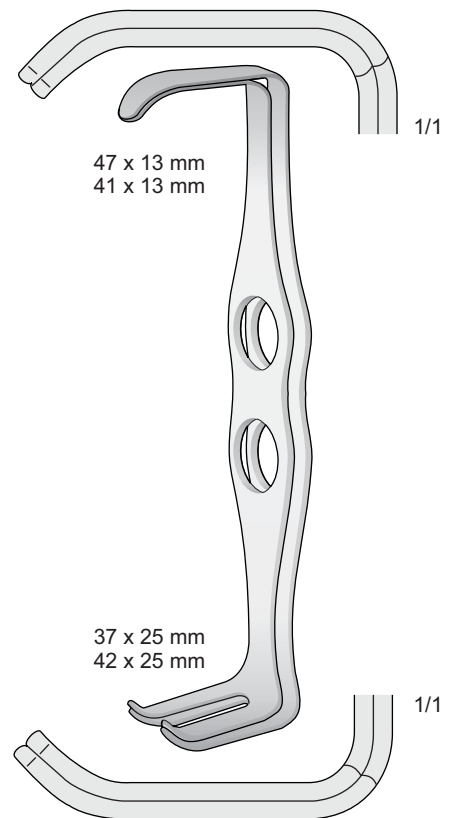

47 x 13 mm
41 x 13 mm

1/1

37 x 25 mm
42 x 25 mm

1/1

MATHIEU
BT-294
200 mm

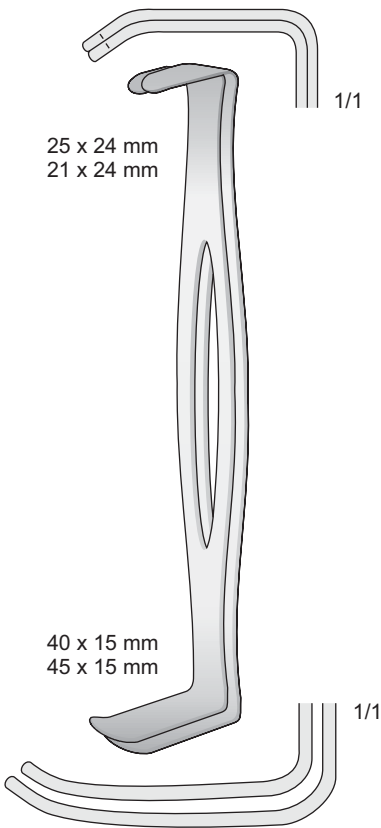

25 x 24 mm
21 x 24 mm

1/1

40 x 15 mm
45 x 15 mm

1/1

PARKER-LANGENBECK
BT-291
210 mm

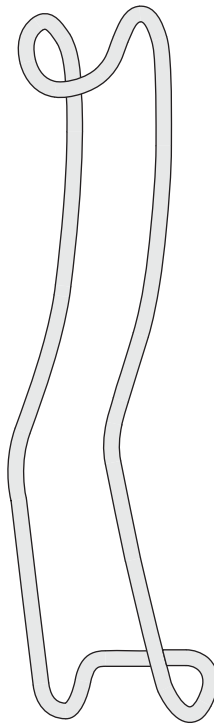

STERNBERG
OM-50
160 mm

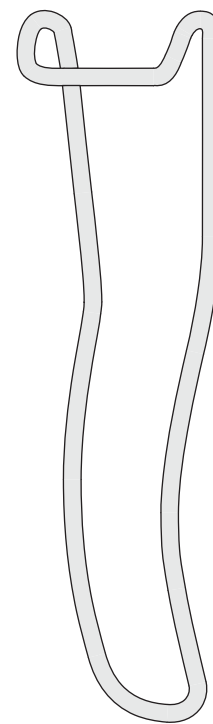

STERNBERG
OM-52
160 mm

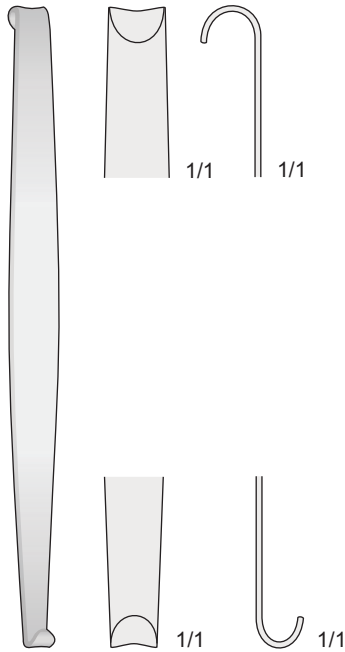

MINI-ROUX
BT-282
150 mm

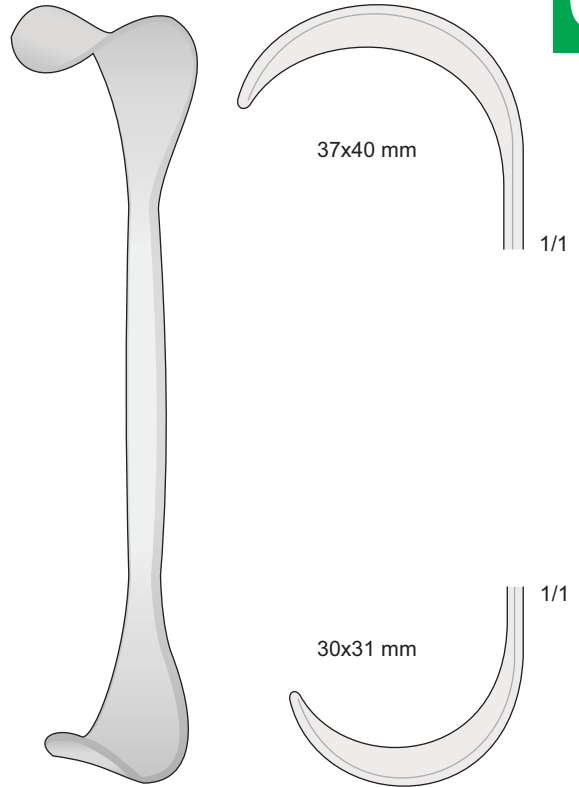

GOELET
BT-83
190 mm

BT-283
Set completo
Set complete
Komplettset
Set complet
Set completo

29 mm
26 mm
22 mm

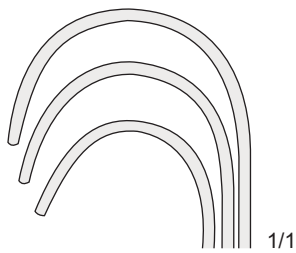

BT-284 - 20x22 mm
25x28 mm
BT-285 - 23x26 mm
29x38 mm
BT-286 - 29x29 mm
34x44 mm

28 mm
38 mm
44 mm

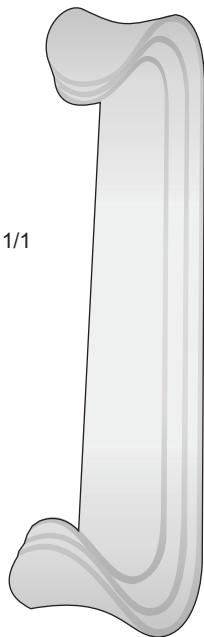

ROUX
BT-284/BT-286
165 mm

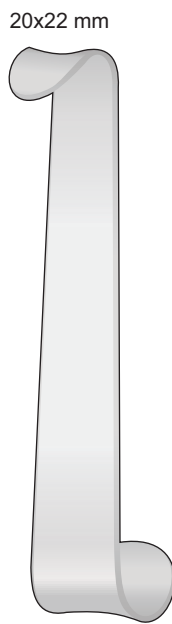

ROUX-MAGNUS
BT-287
150 mm

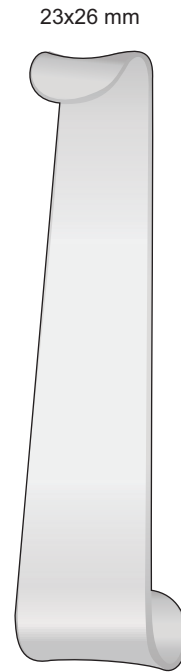

ROUX-MAGNUS
BT-288
160 mm

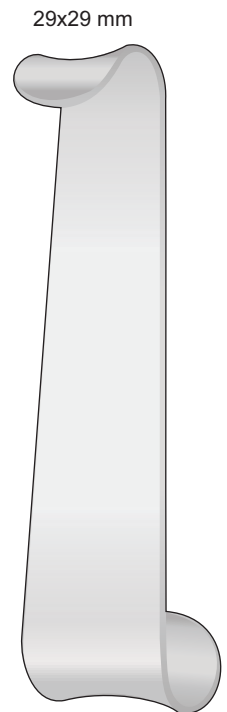

ROUX-MAGNUS
BT-289
170 mm

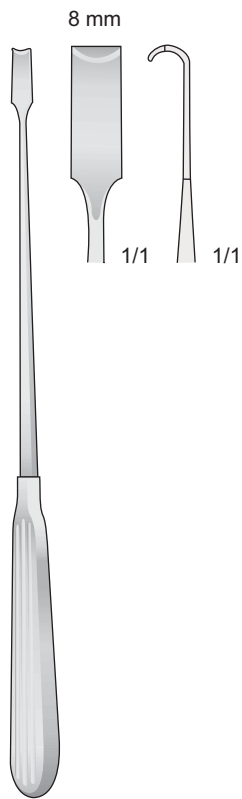

SCOVILLE
BT-312
230 mm

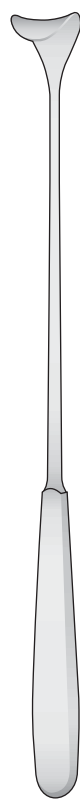

CUSHING
BT-114/BT-116
250 mm

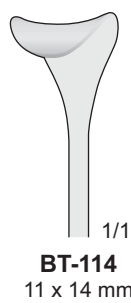

BT-114
11 x 14 mm

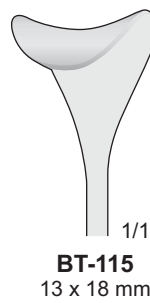

BT-115
13 x 18 mm

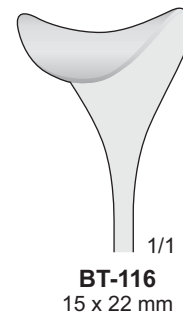

BT-116
15 x 22 mm

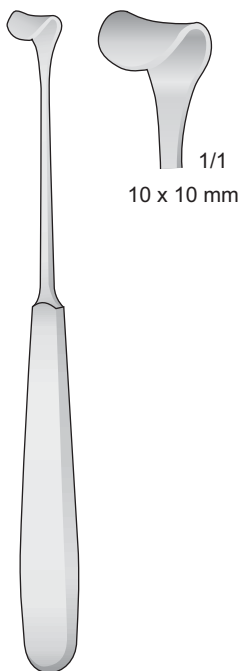

CUSHING-KOCHER
BT-113
180 mm



KOCHER
BT-117/BT-118
205 mm

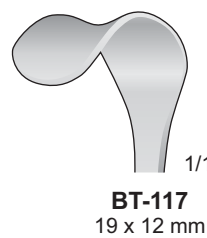

BT-117
19 x 12 mm

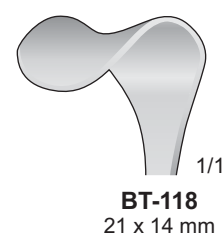

BT-118
21 x 14 mm

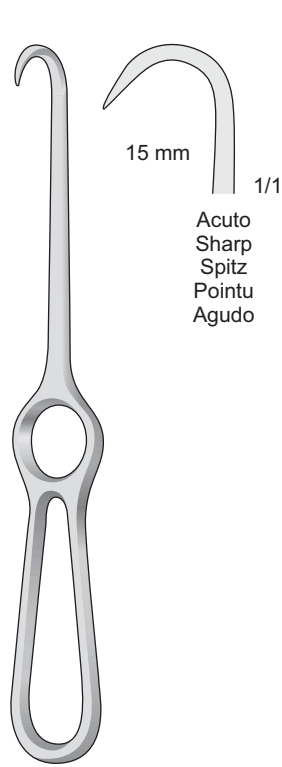

15 mm 1/1
Acuto
Sharp
Spitz
Pointu
Agudo

**KOCHER
BT-139**
205 mm

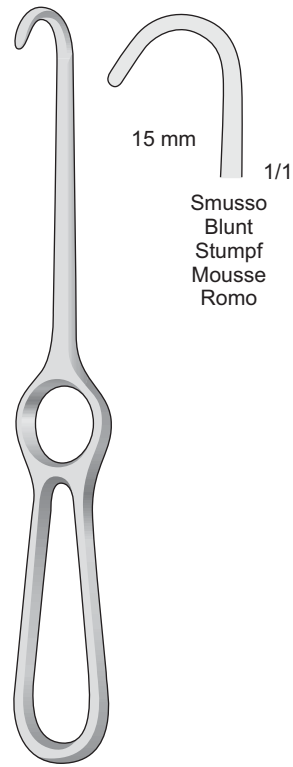

15 mm 1/1
Smusso
Blunt
Stumpf
Mousse
Romo

**KOCHER
BT-140**
220 mm

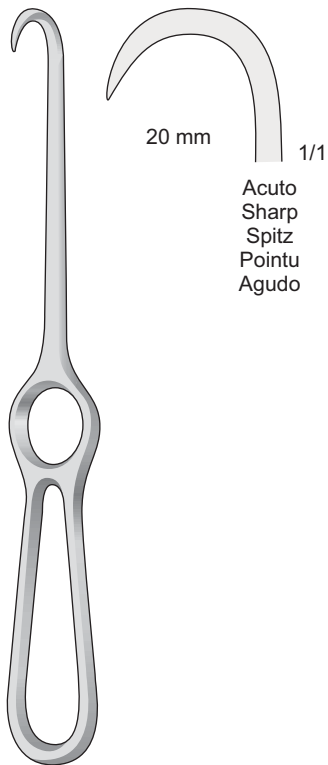

20 mm 1/1
Acuto
Sharp
Spitz
Pointu
Agudo

**VOLKMANN
BT-126**
220 mm

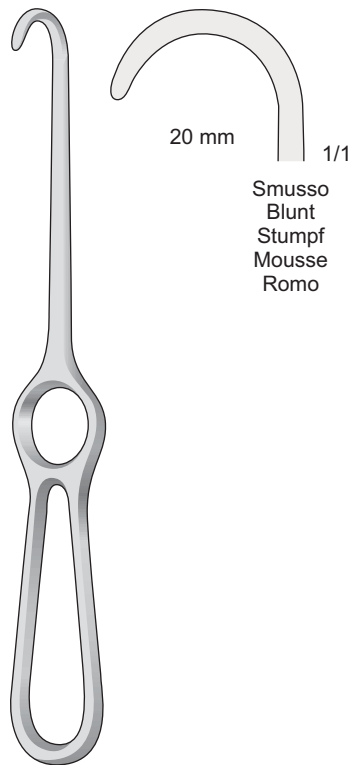

20 mm 1/1
Smusso
Blunt
Stumpf
Mousse
Romo

**VOLKMANN
BT-127**
220 mm

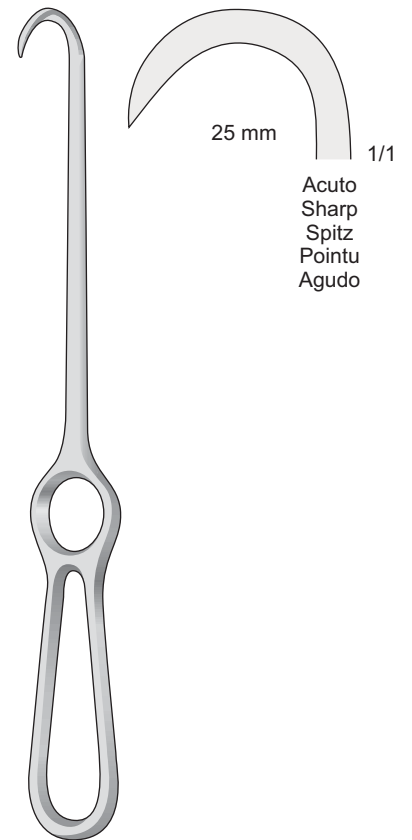

25 mm 1/1
Acuto
Sharp
Spitz
Pointu
Agudo

BT-128
245 mm

	<p>Acuto Sharp Spitz Pointu Agudo</p>	<p>1/1</p>	<p>BT-101 9 x 8 mm</p>	<p>BT-103 9 x 13 mm</p>	<p>BT-105 9 x 19 mm</p>	<p>BT-107 9 x 29 mm</p>
	<p>Smusso Blunt Stumpf Mousse Romo</p>	<p>1/1</p>	<p>BT-102 8 x 8 mm</p>	<p>BT-104 8 x 13 mm</p>	<p>BT-106 8 x 19 mm</p>	<p>BT-108 8 x 29 mm</p>
	<p>VOLKMANN BT-101/BT-108 220 mm</p>					

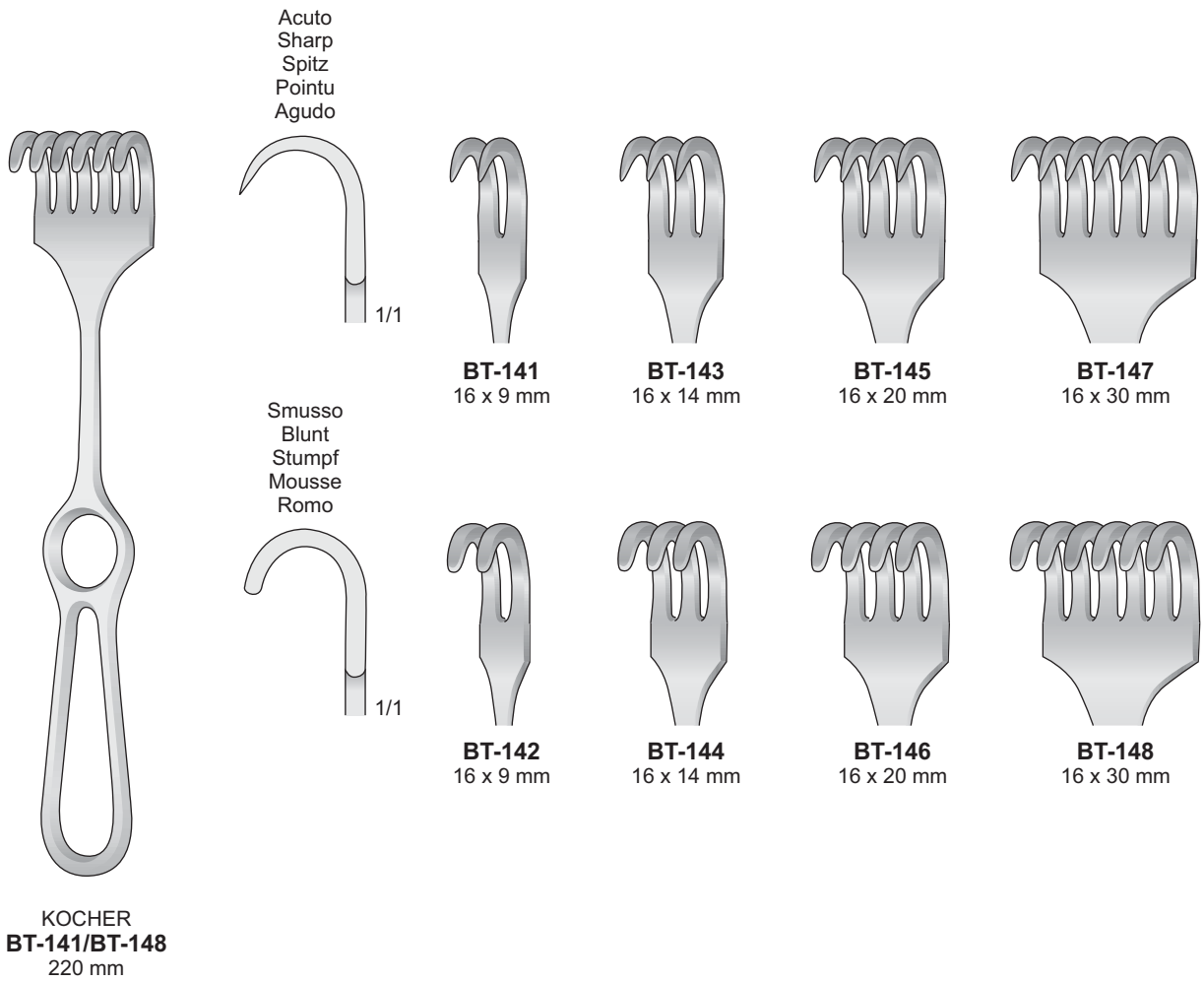

09

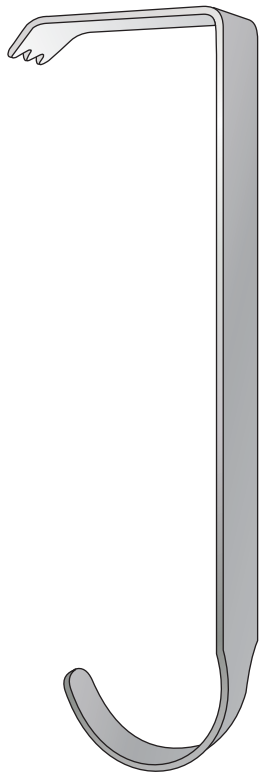

1/1

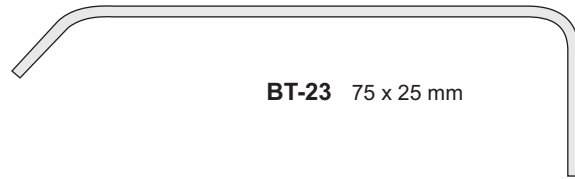

BT-23 75 x 25 mm

1/1

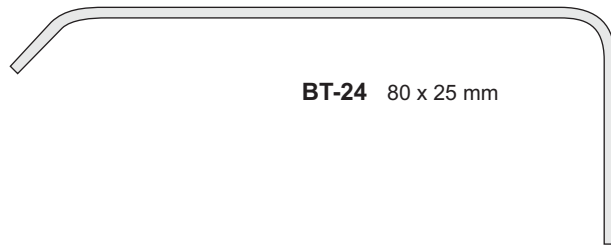

BT-24 80 x 25 mm

1/1

HIBBS
BT-23/BT-24
240 mm

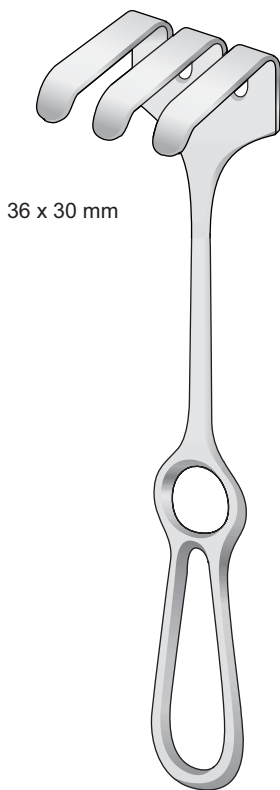

36 x 30 mm

OLLIER
BT-124
225 mm

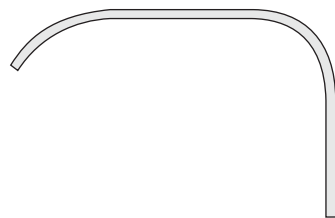

1/1

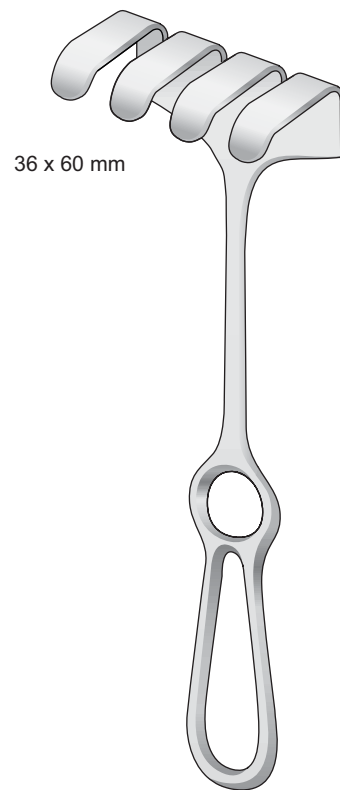

36 x 60 mm

OLLIER
BT-125
225 mm

40 x 40 mm

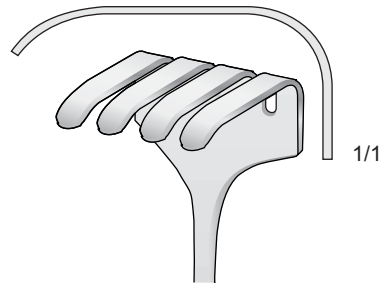

BT-120

45 x 50 mm

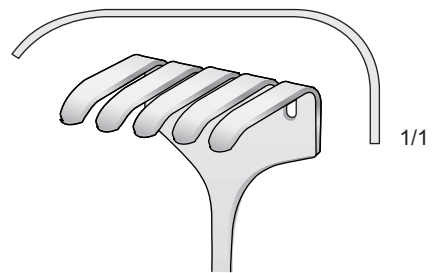

BT-121

50 x 60 mm

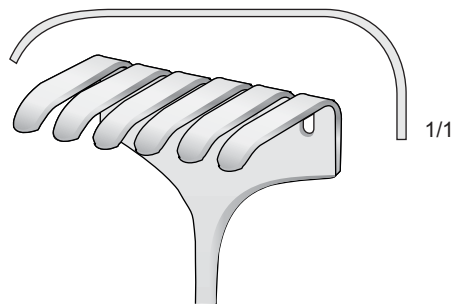

BT-122

70 x 70 mm

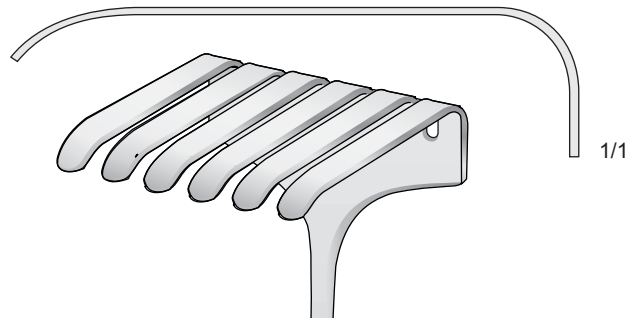

BT-123

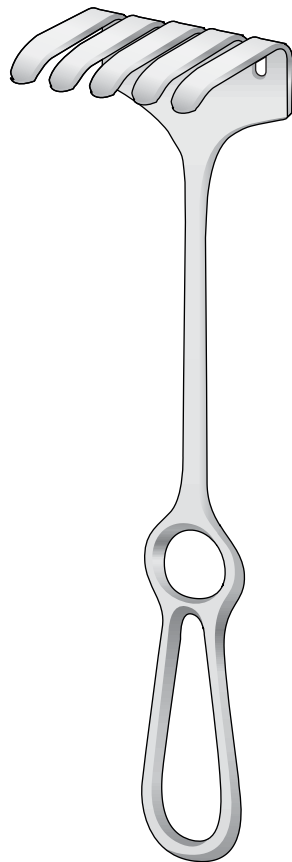

ISRAEL
BT-120/BT-123
250 mm

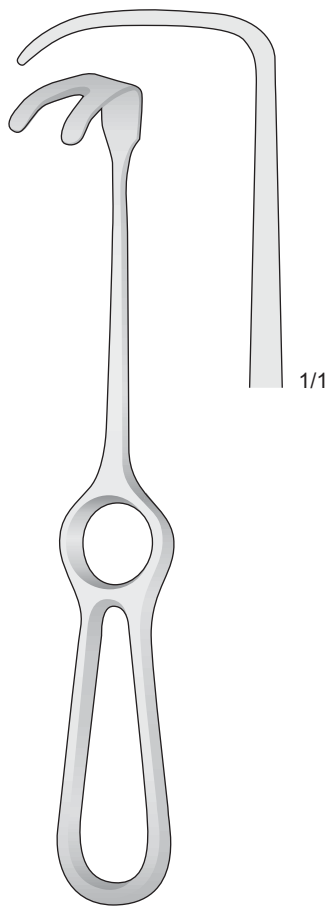

WASSMUND
BT-69
220 mm

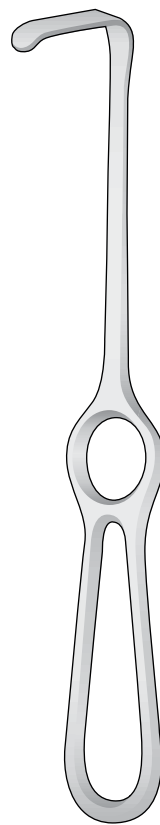

LANGENBECK
BT-33/BT-43
210 mm

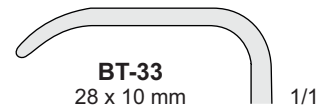

BT-33
28 x 10 mm

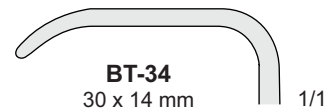

BT-34
30 x 14 mm

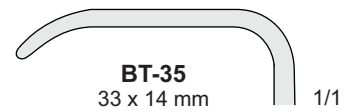

BT-35
33 x 14 mm

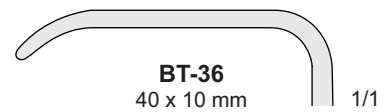

BT-36
40 x 10 mm

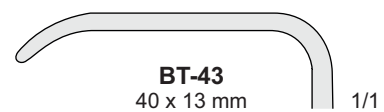

BT-43
40 x 13 mm

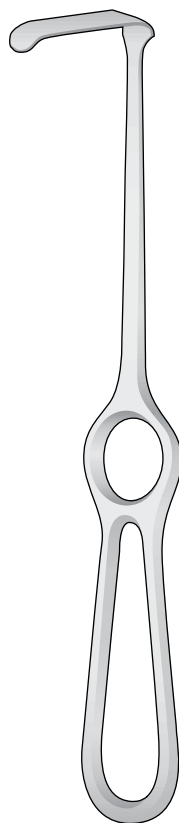
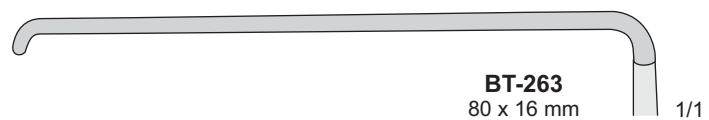
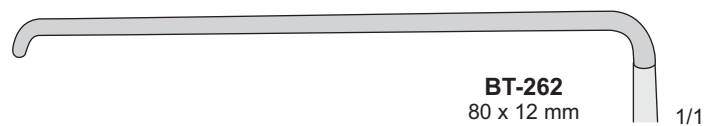
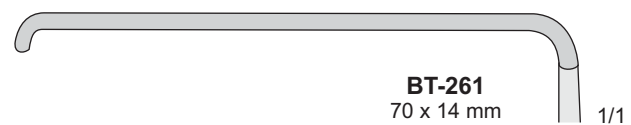
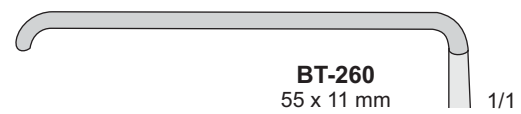
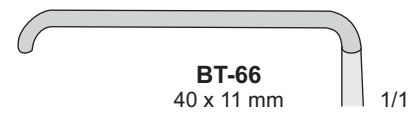
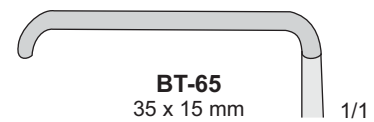
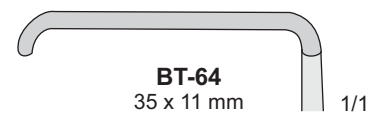
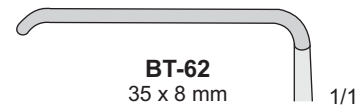
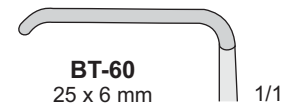

KOCHER-LANGENBECK
BT-60/BT-263
215 mm

09

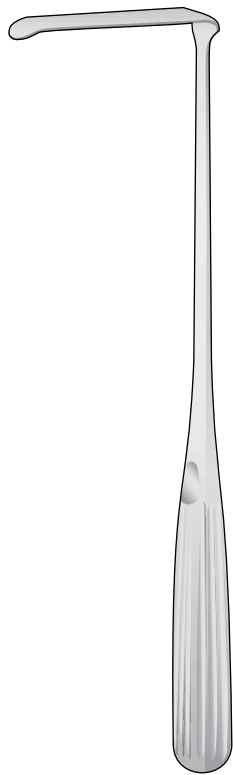

SAUERBRUCH
BT-110/BT-112
225 mm

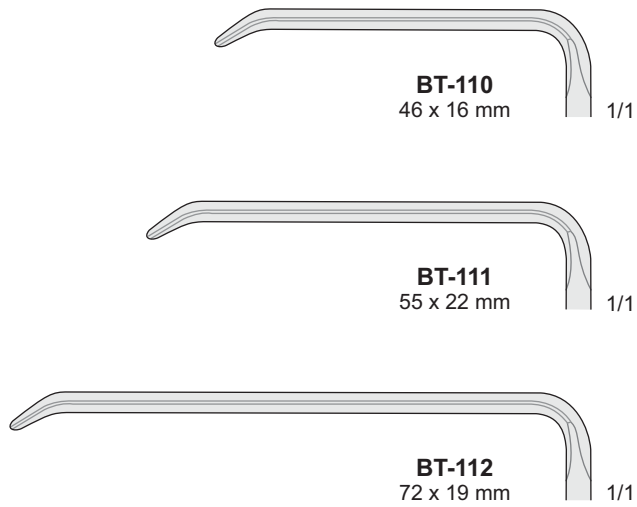

BT-110
46 x 16 mm 1/1

BT-111
55 x 22 mm 1/1

BT-112
72 x 19 mm 1/1

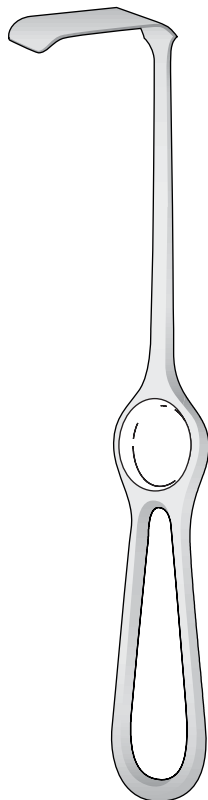

KOCHER
BT-250/BT-254
230 mm

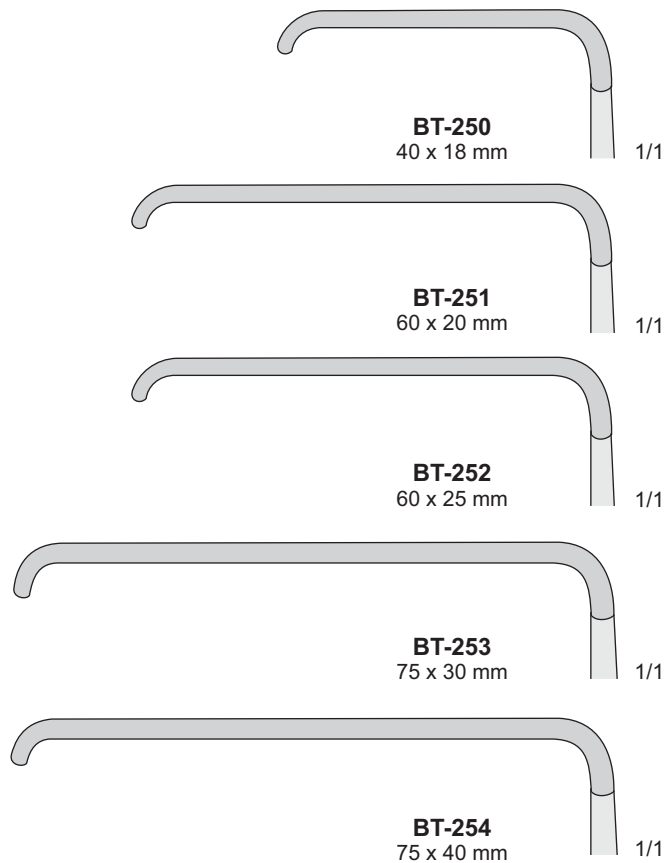

BT-250
40 x 18 mm 1/1

BT-251
60 x 20 mm 1/1

BT-252
60 x 25 mm 1/1

BT-253
75 x 30 mm 1/1

BT-254
75 x 40 mm 1/1

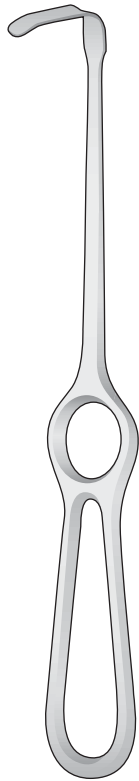

OBWEGESER
BT-152/BT-157
220 mm

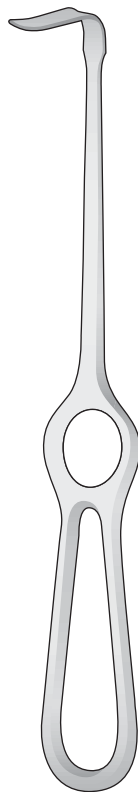

OBWEGESER
BT-92/BT-100
220 mm



BT-152
25 x 7 mm



BT-153
31 x 10 mm

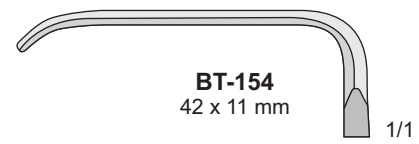

BT-154
42 x 11 mm

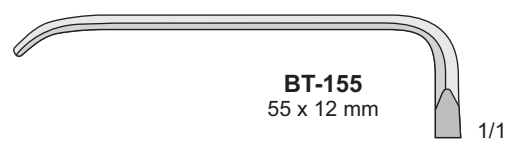

BT-155
55 x 12 mm

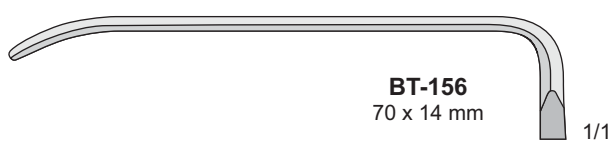

BT-156
70 x 14 mm

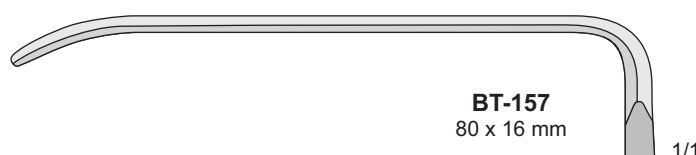

BT-157
80 x 16 mm

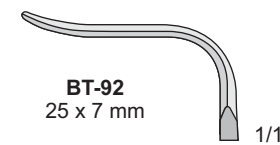

BT-92
25 x 7 mm

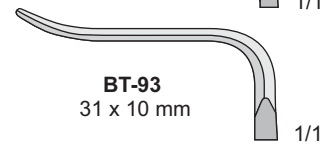

BT-93
31 x 10 mm

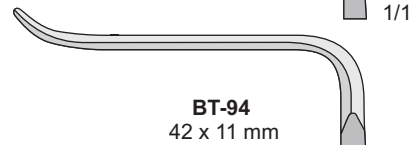

BT-94
42 x 11 mm

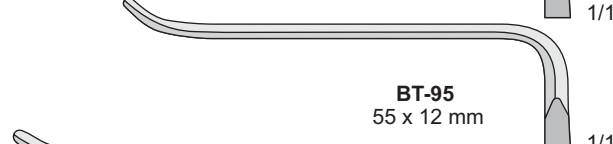

BT-95
55 x 12 mm

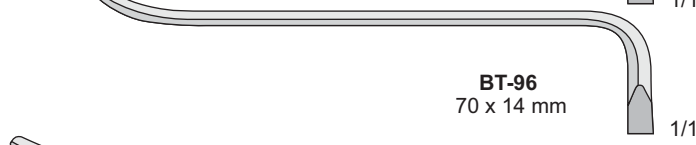

BT-96
70 x 14 mm

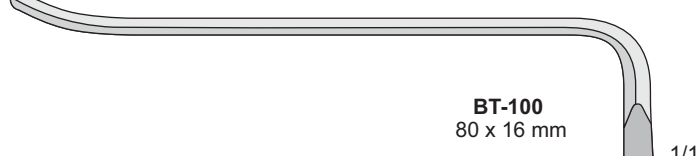

BT-100
80 x 16 mm

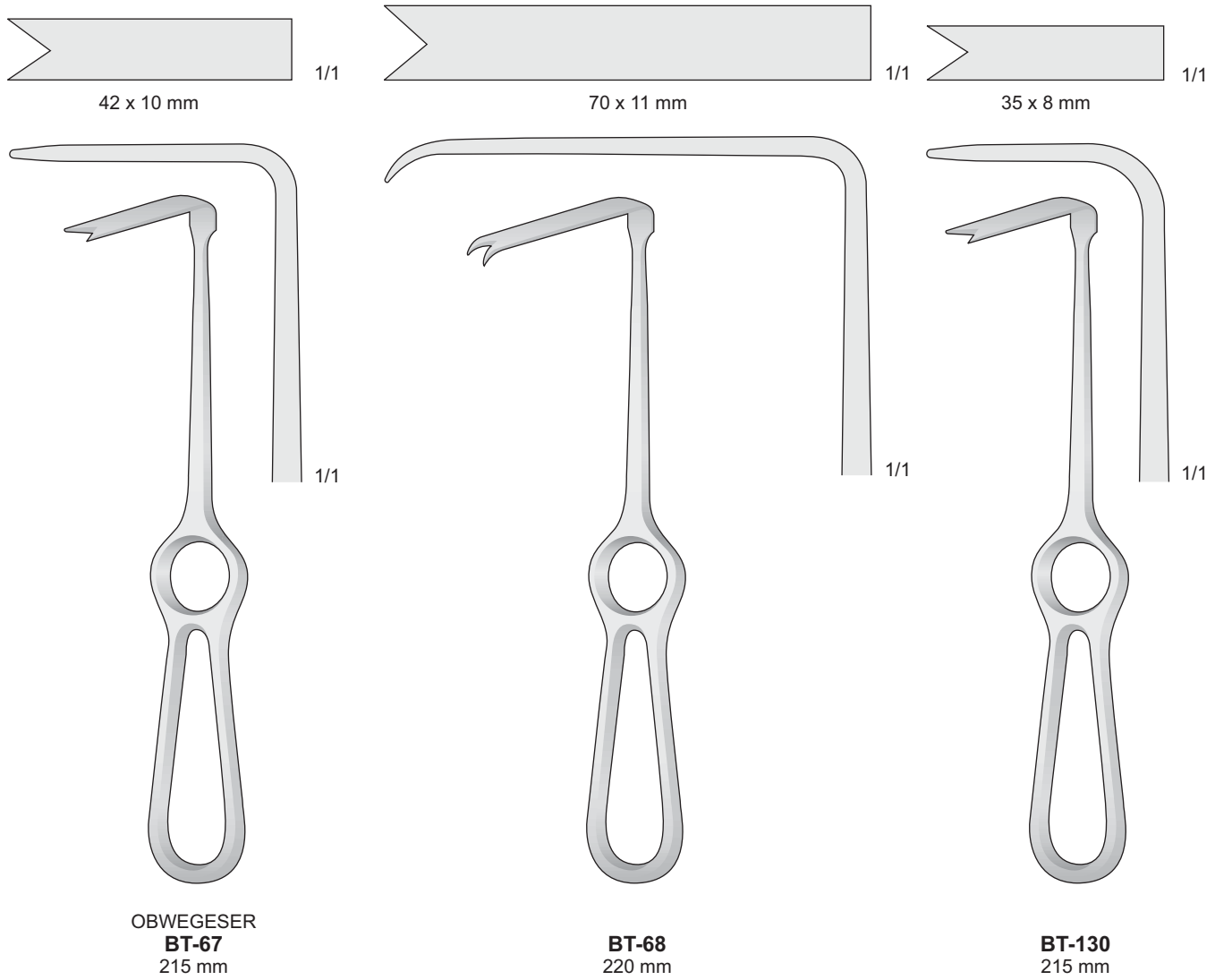

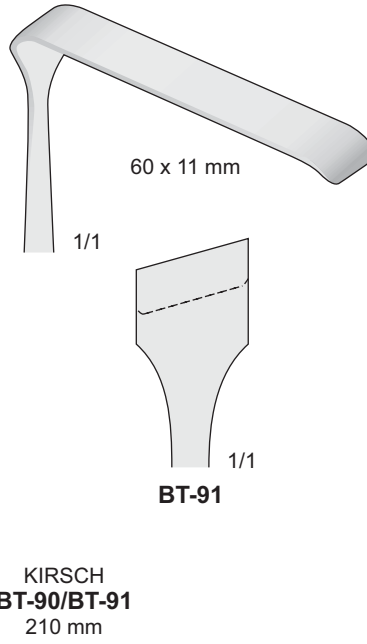
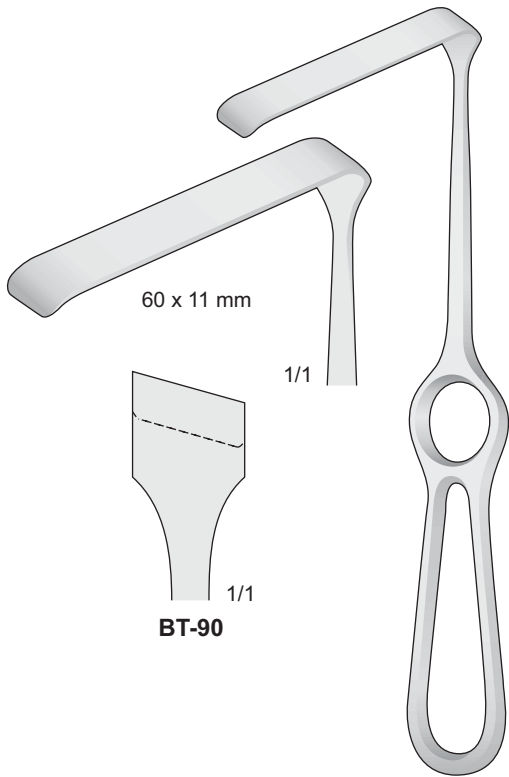

KIRSCH
BT-90/BT-91
210 mm

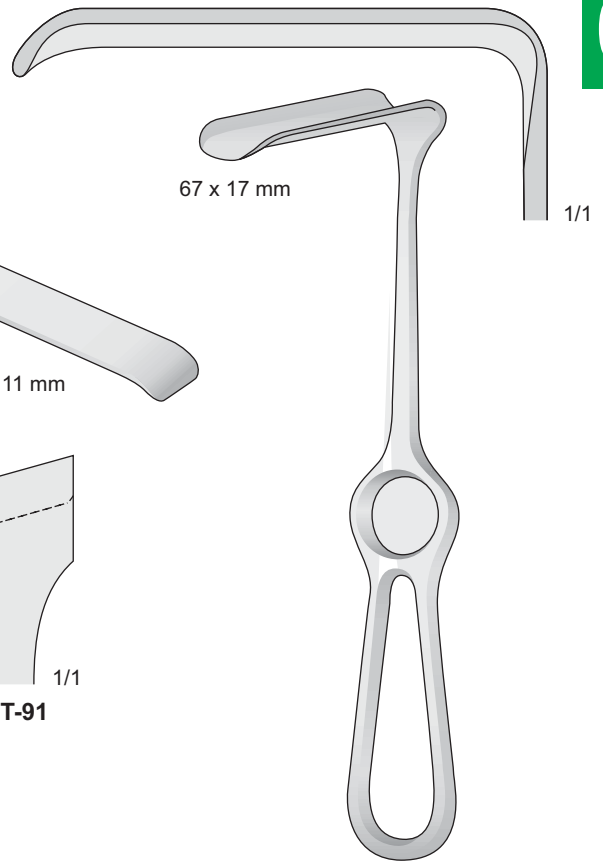

CASPAR
BT-136
210 mm

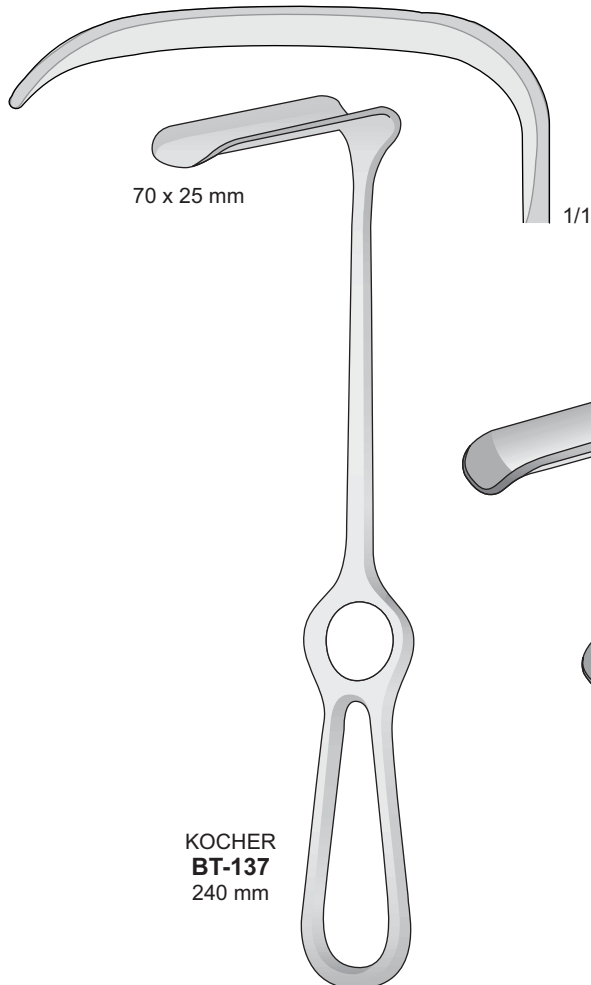

KOCHER
BT-137
240 mm

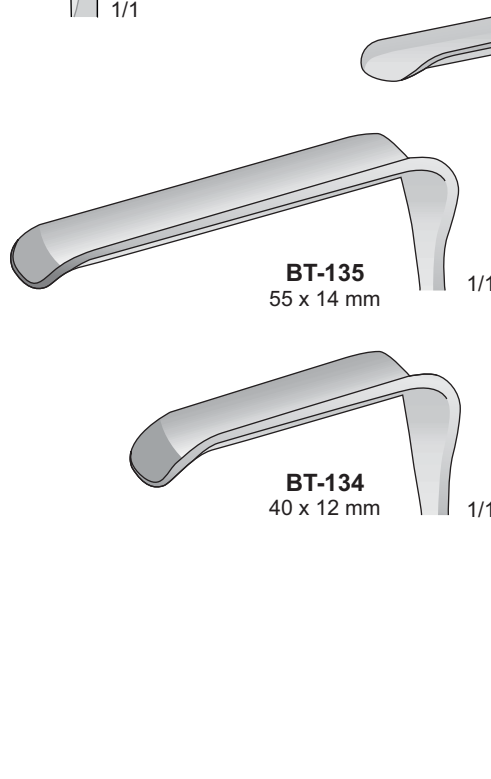

DOCKHORN
BT-134/BT-135
210 mm

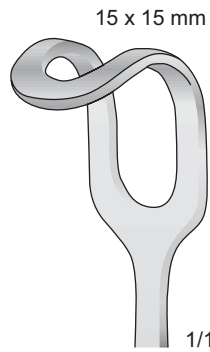

BT-80
225 mm

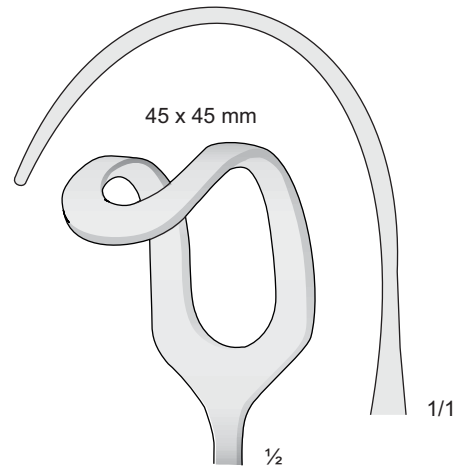

BT-180
255 mm

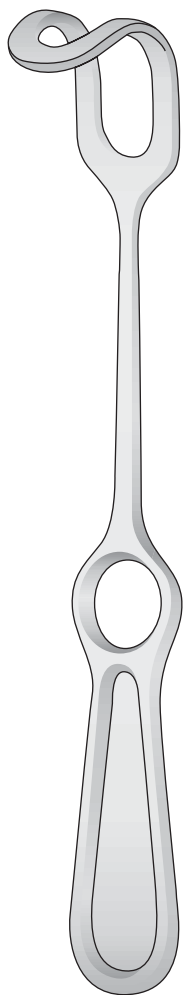

MIDDELDORPF
BT-80/BT-82
225 mm

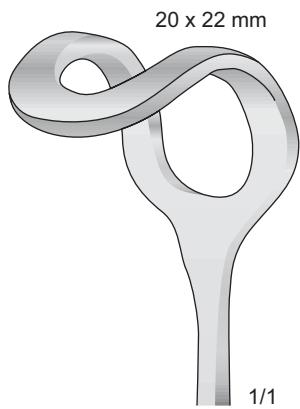

BT-81
225 mm

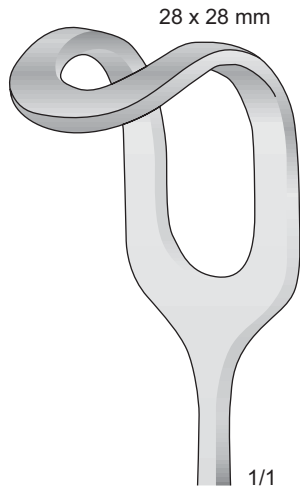

BT-82
225 mm

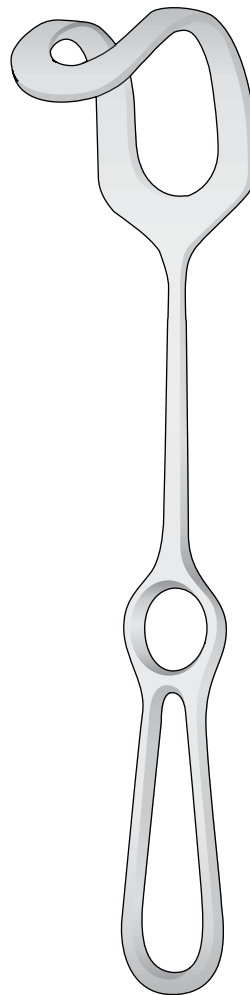

MIDDELDORPF
BT-180
255 mm

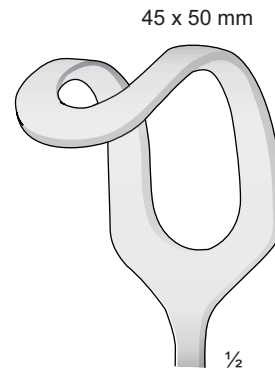

BT-181
255 mm

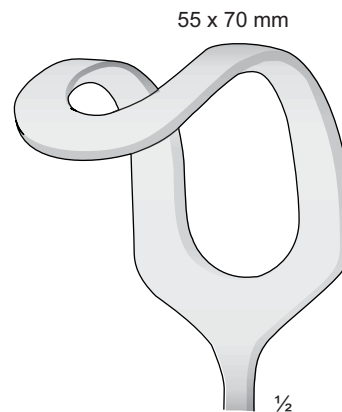

BT-182
255 mm

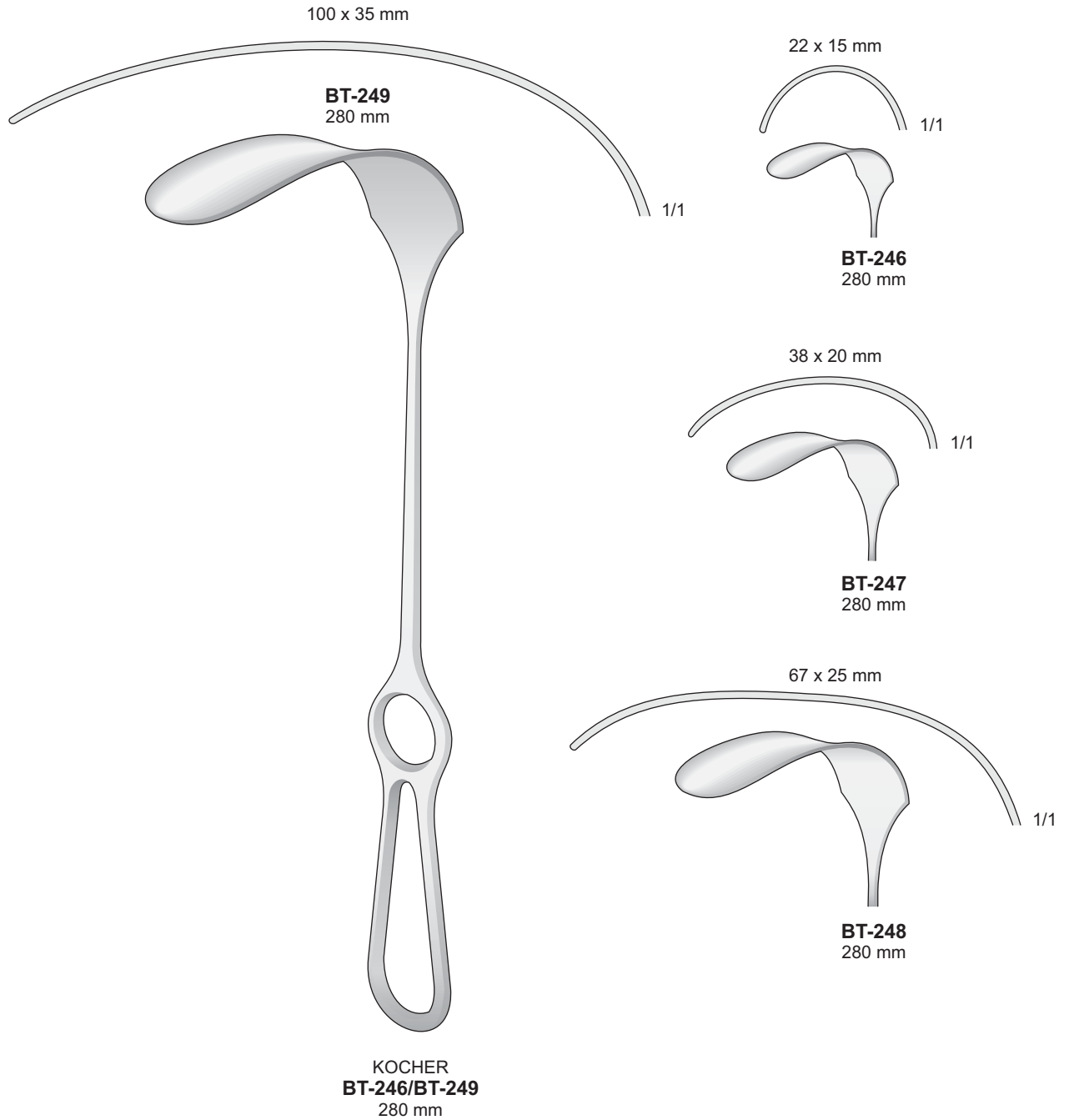

09

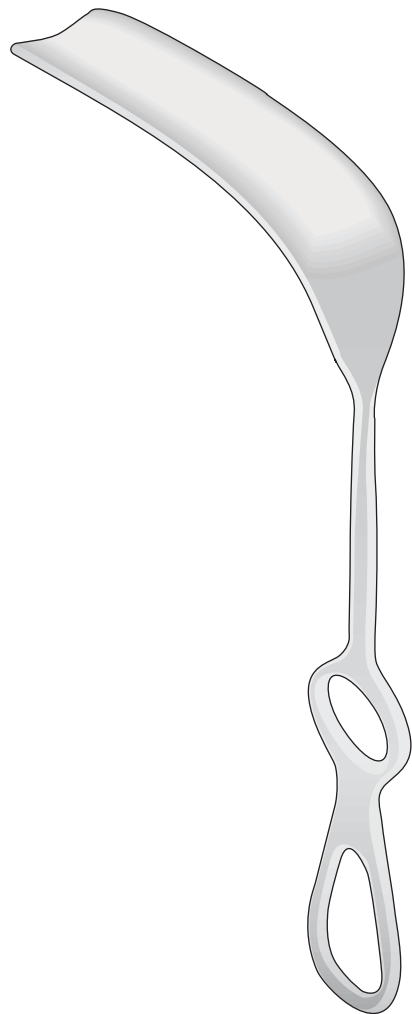
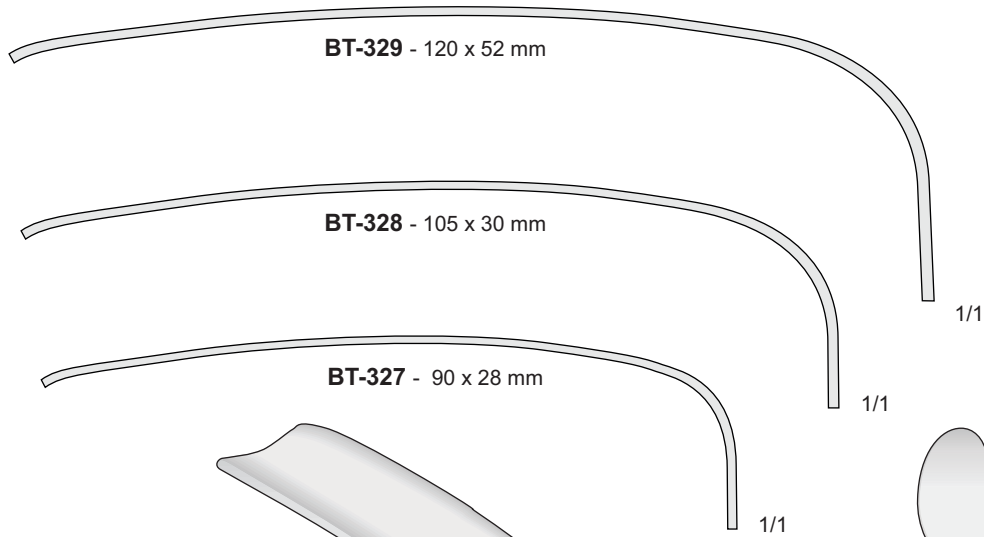

DOYEN-STILLE
BT-327/BT-329
220 mm



50 x 85 mm

DOYEN
BT-330
250 mm

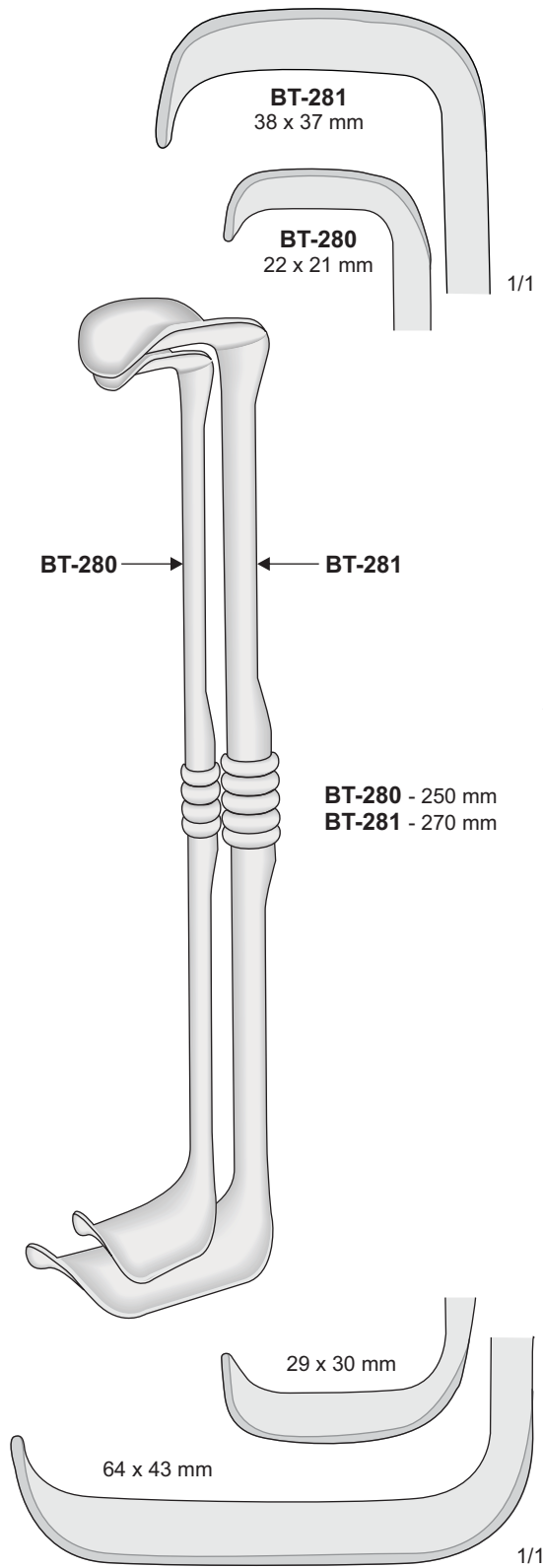

RICHARDSON-EASTMAN
BT-290
Set 2 pezzi

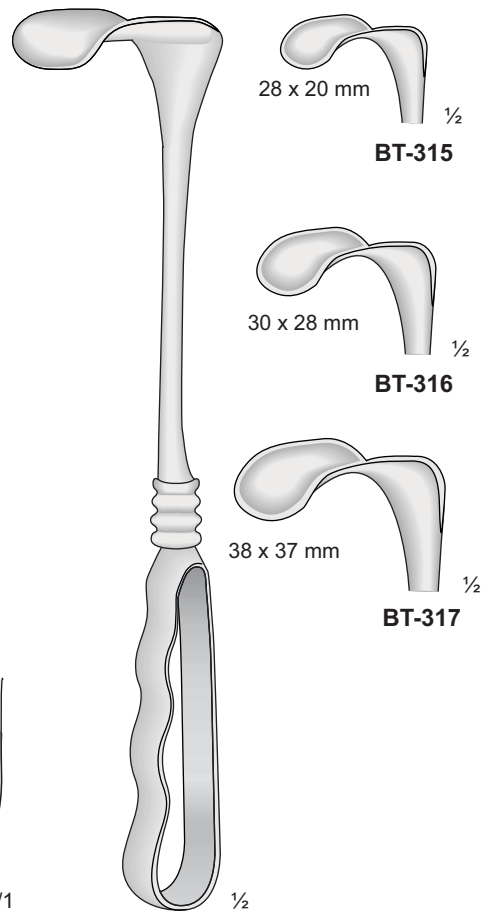

RICHARDSON
BT-315/BT-317
240 mm

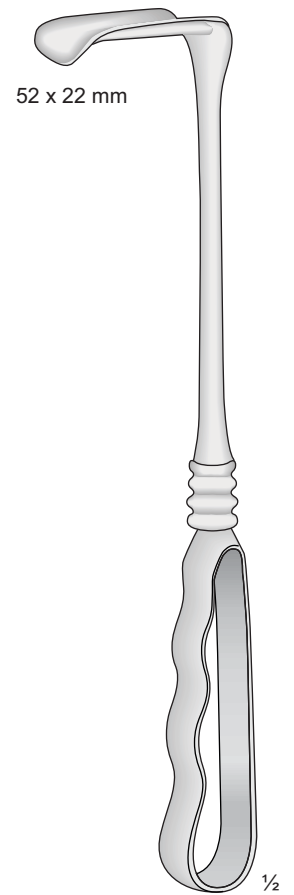

RICHARDSON
BT-318
240 mm

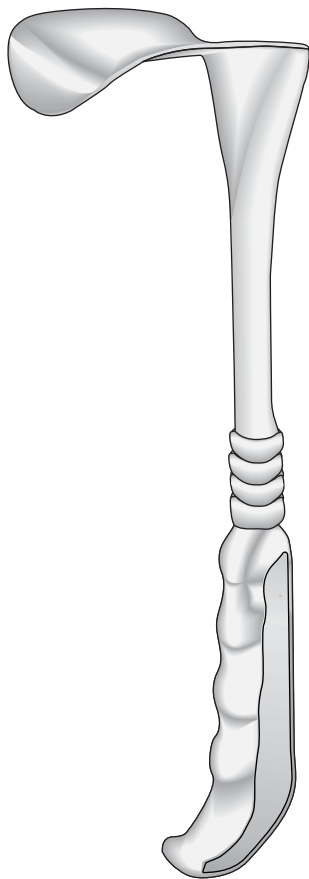

KELLY
BT-319/BT-322
260 mm

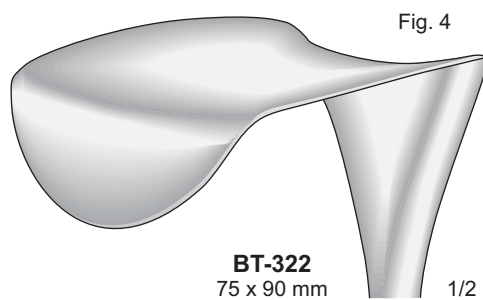
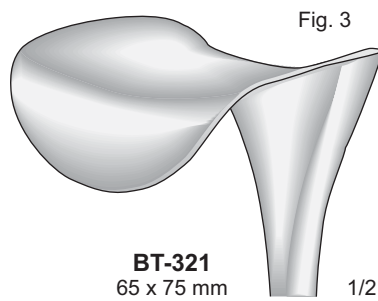
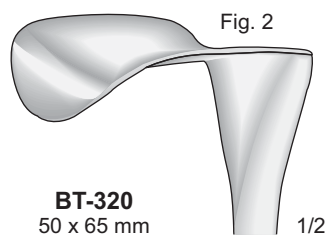
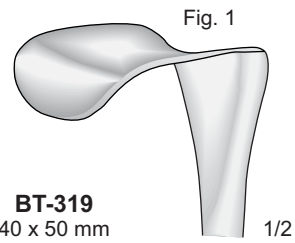

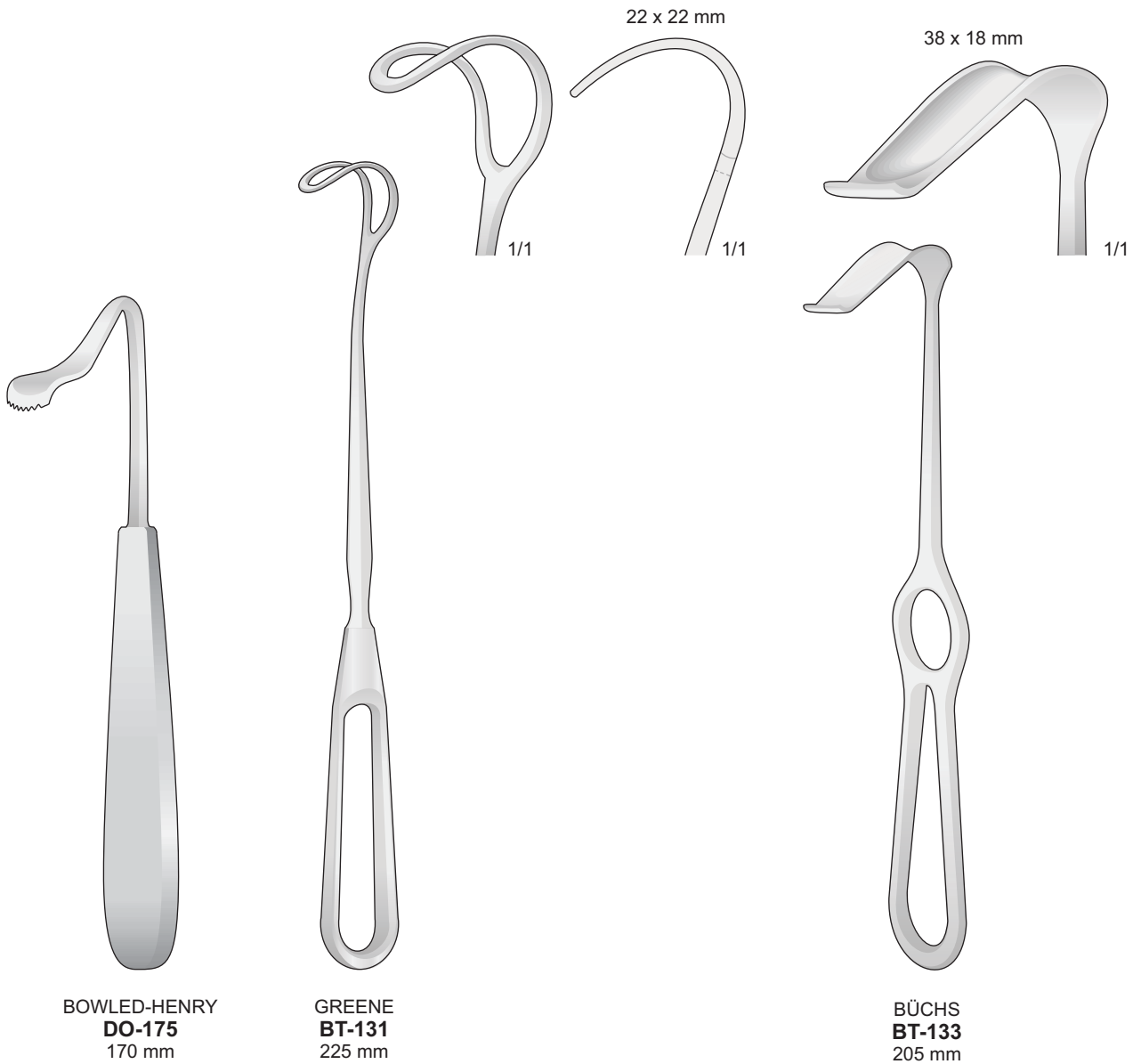

09

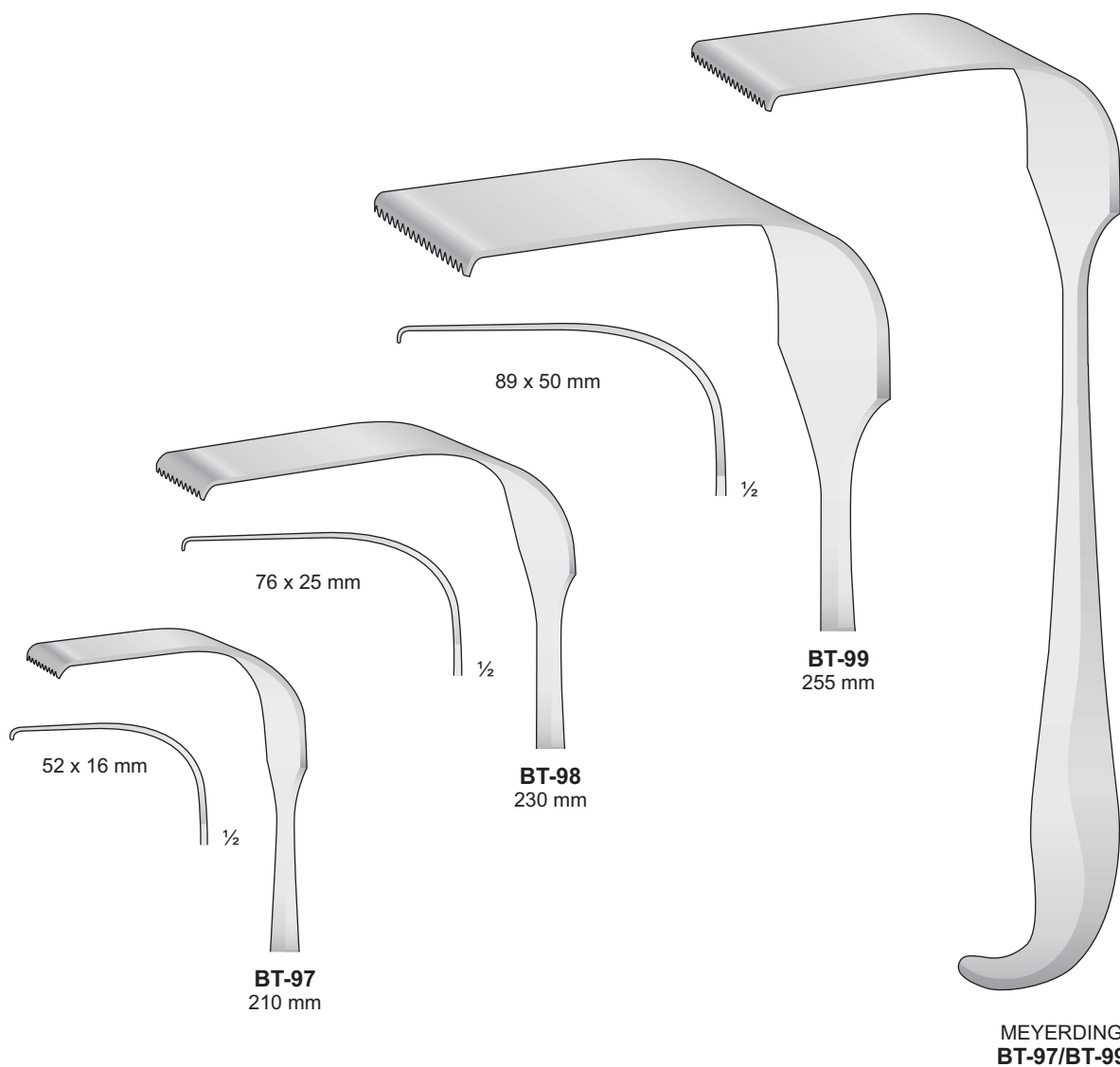

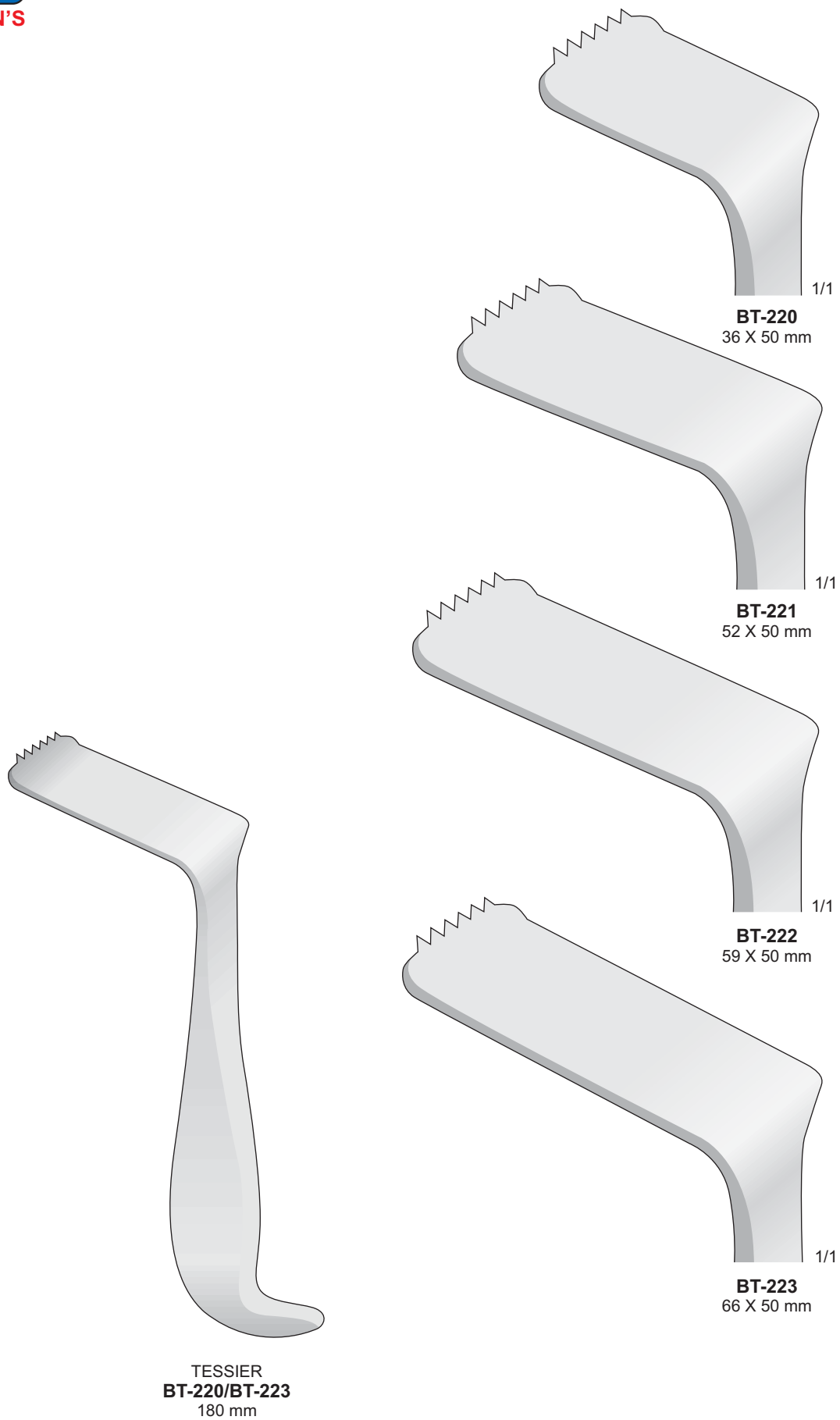

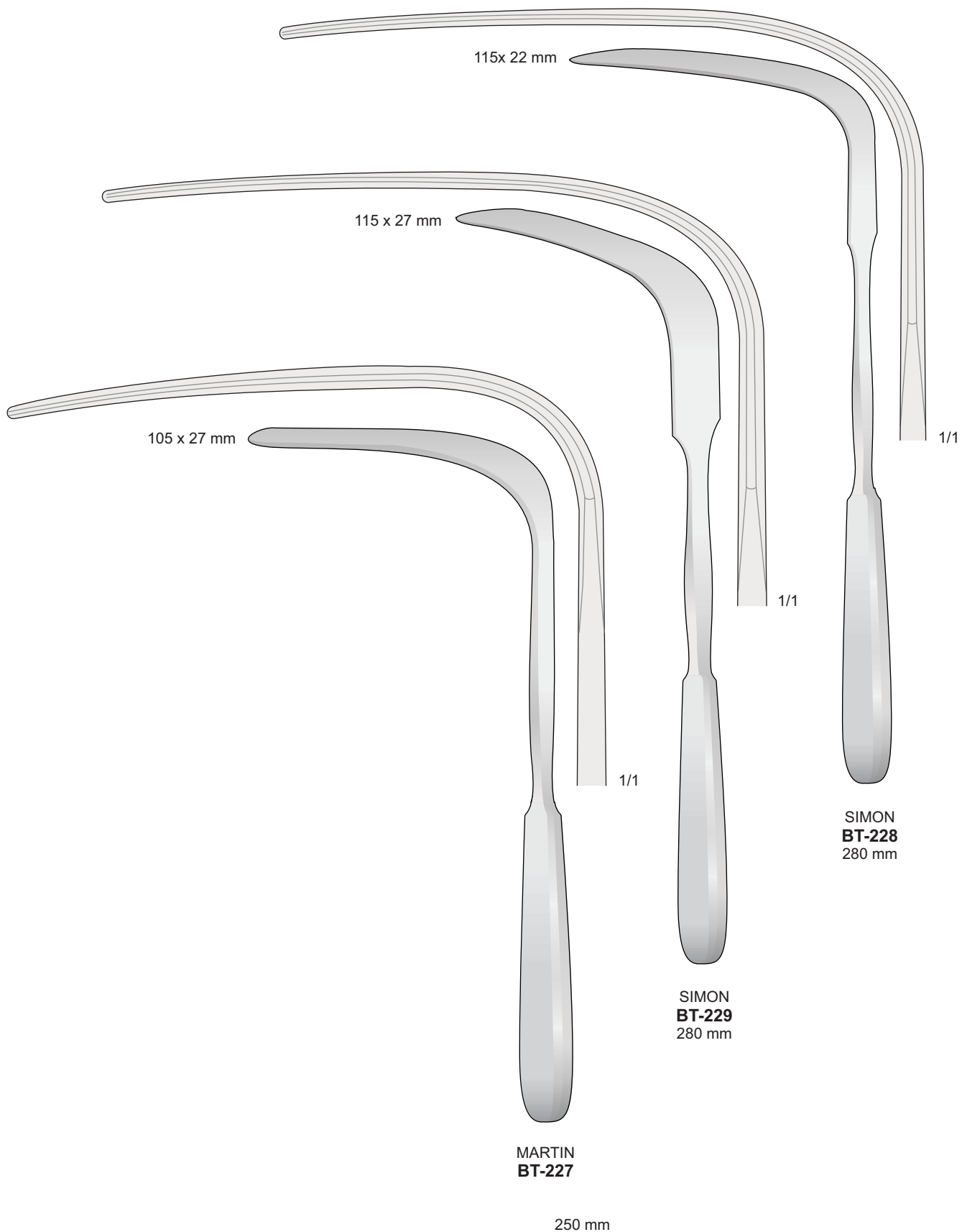

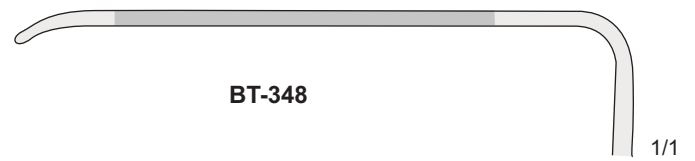
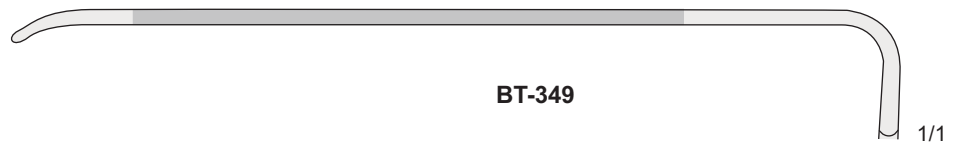
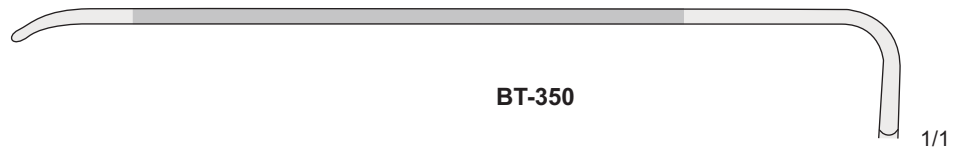
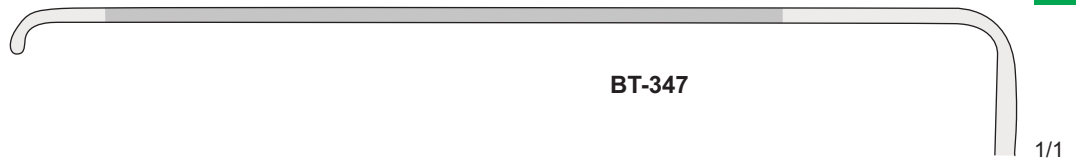

SAUERBRUCH
BT-347
260 mm

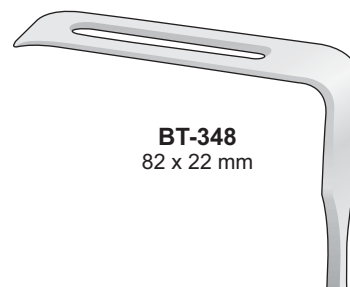
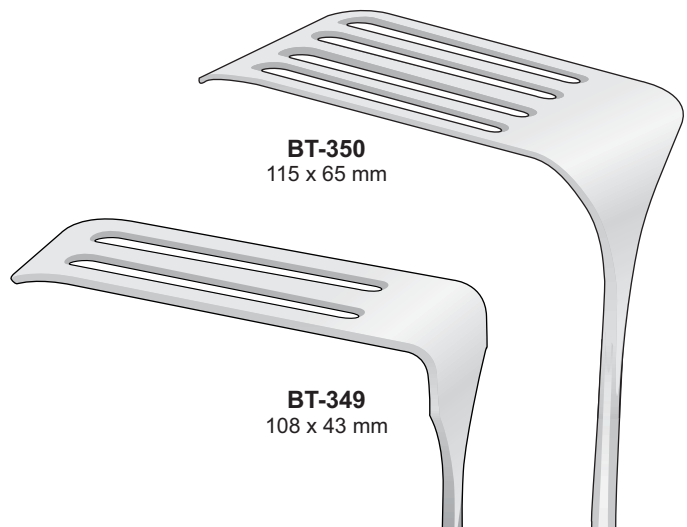

CORYLLOS
BT-348/BT-350
255 mm

Retrattori per scapola
 Scapula retractors
 Scapula-Haken
 Ecarteurs pour scapula
 Separadores para scápula

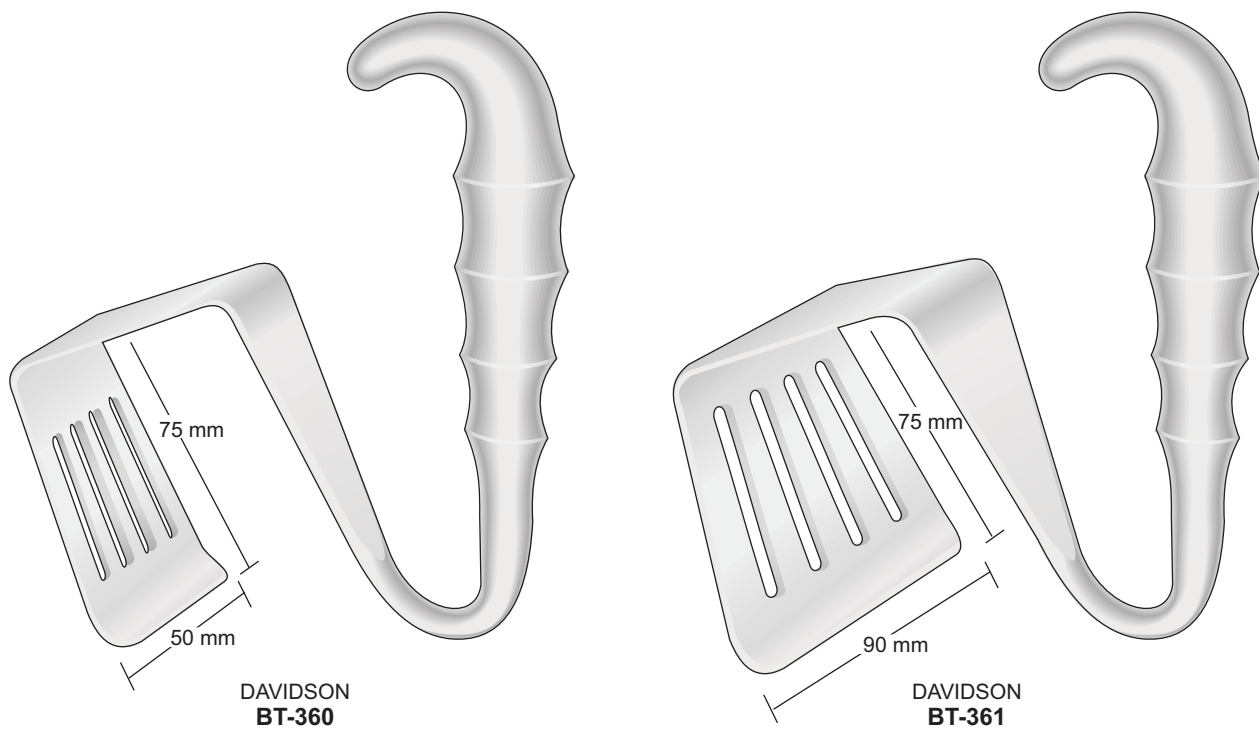

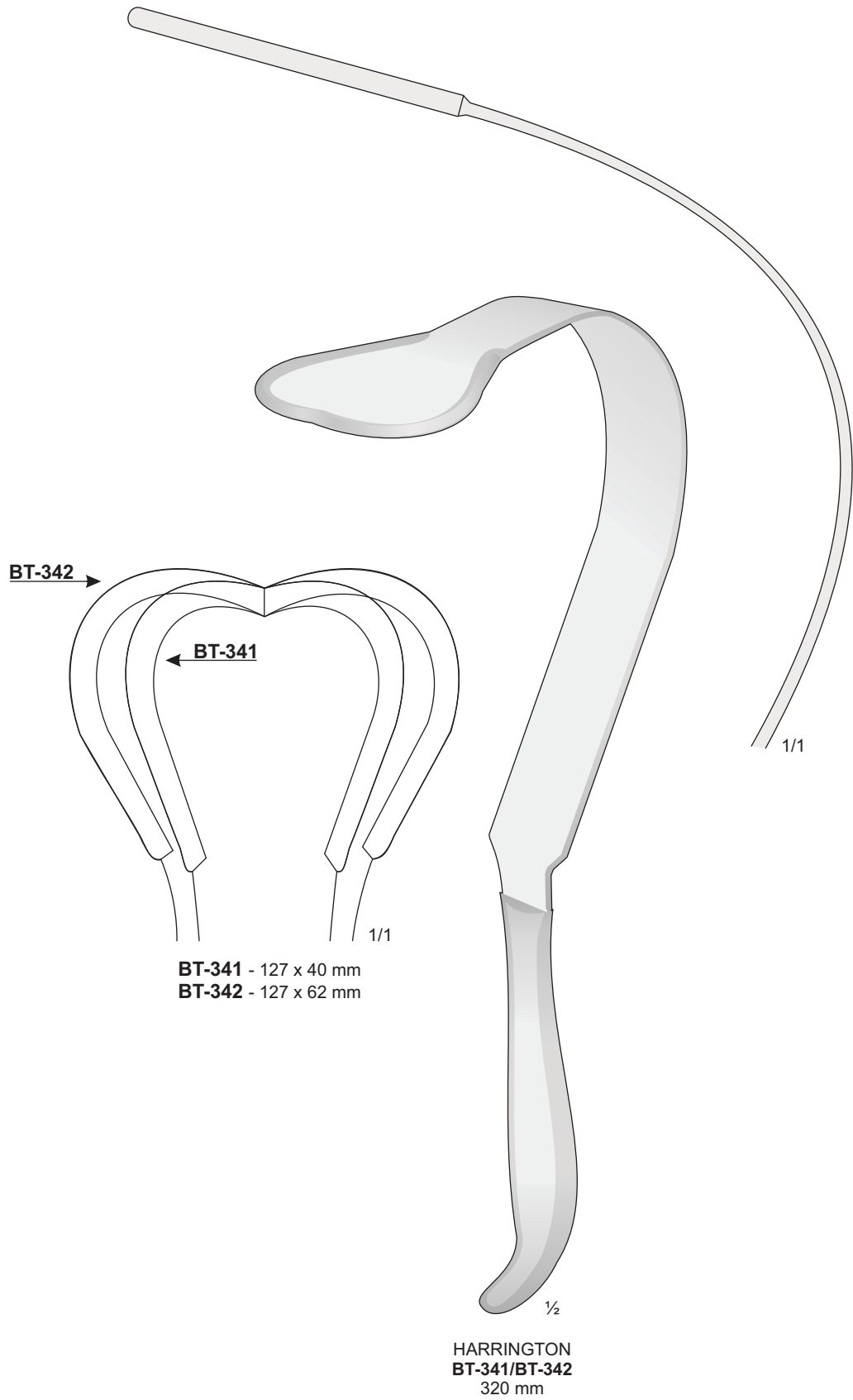

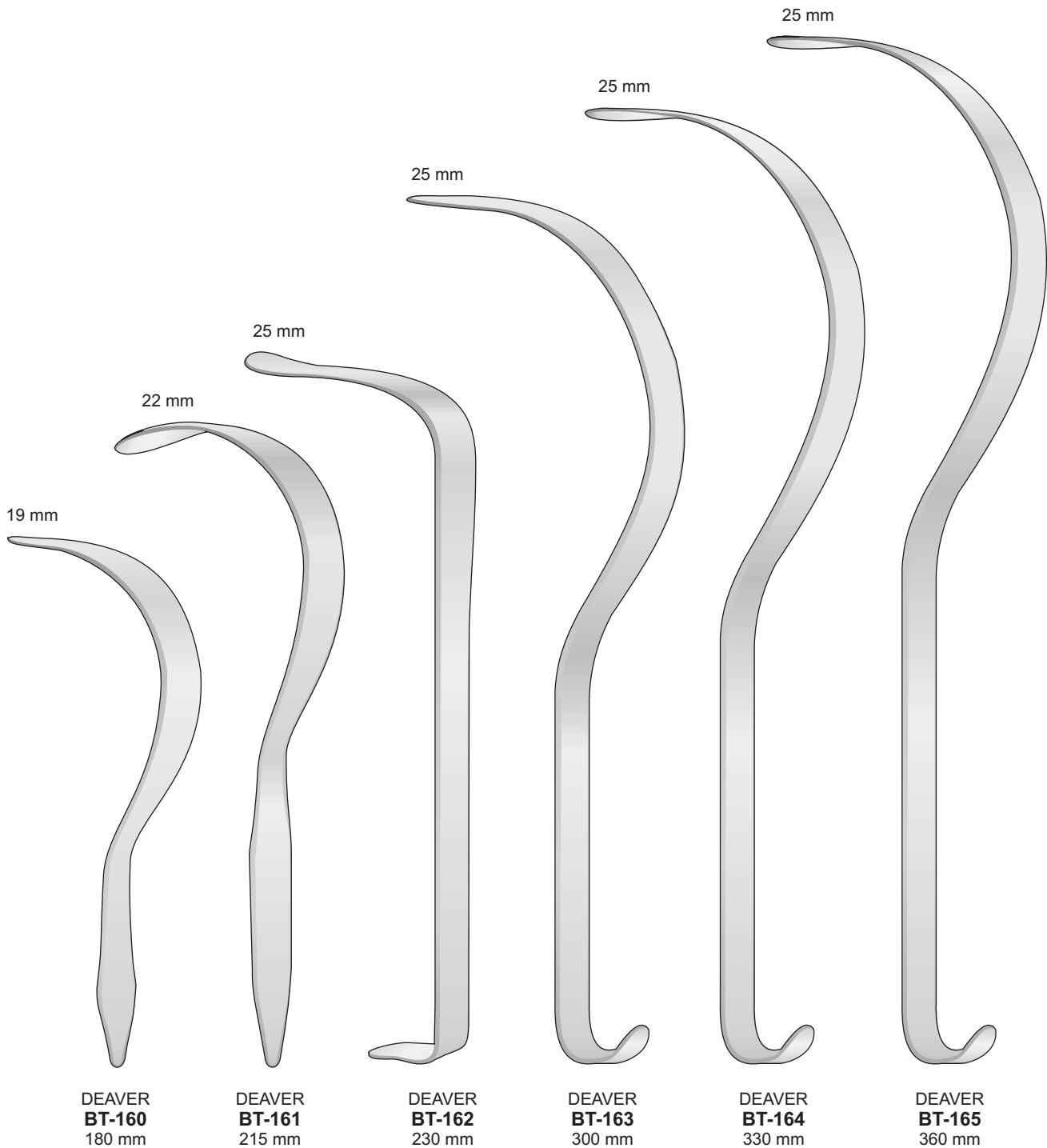

38 mm

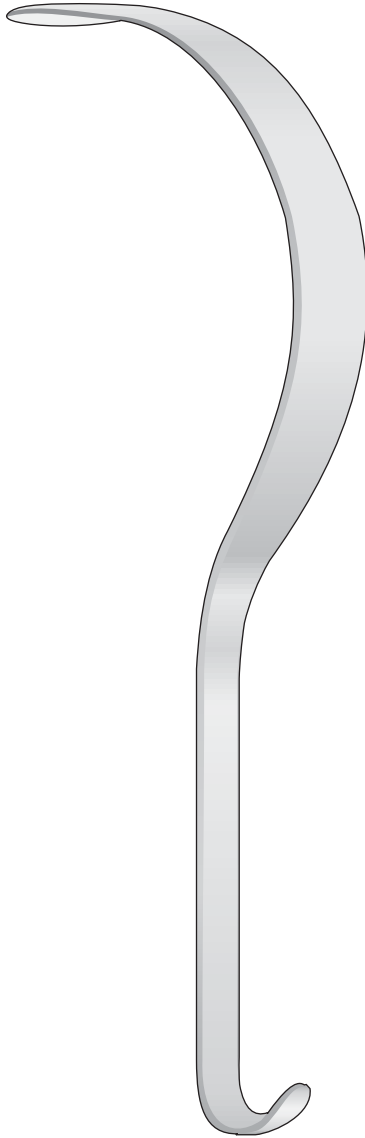

DEAVER
BT-166
300 mm

50 mm

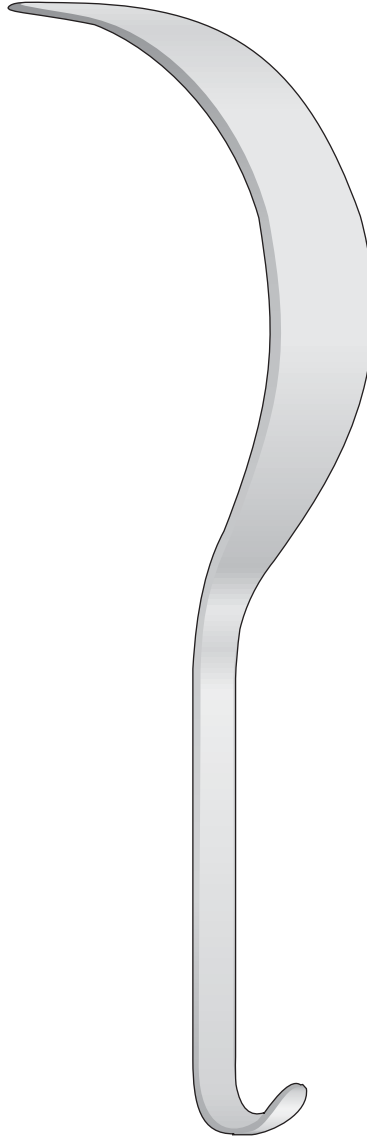

DEAVER
BT-167
300 mm

75 mm

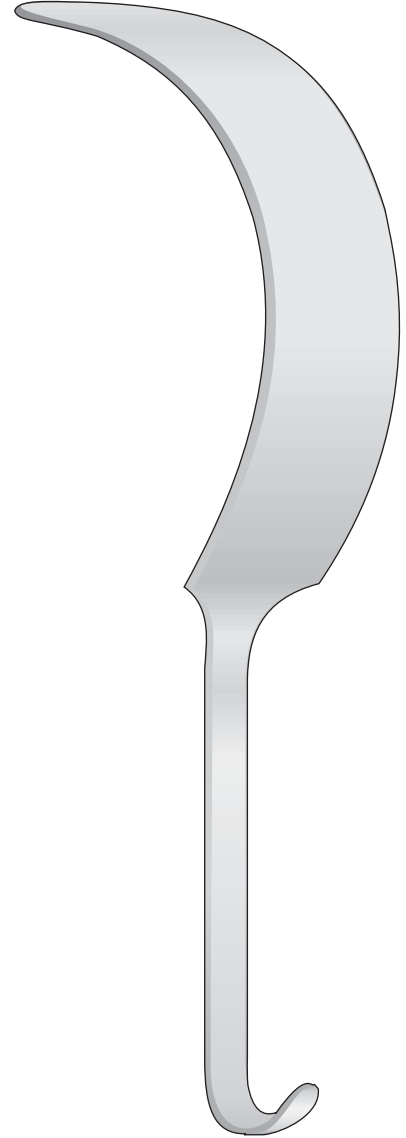

DEAVER
BT-168
300 mm

Rigido - Fest - Rigid - Rigida

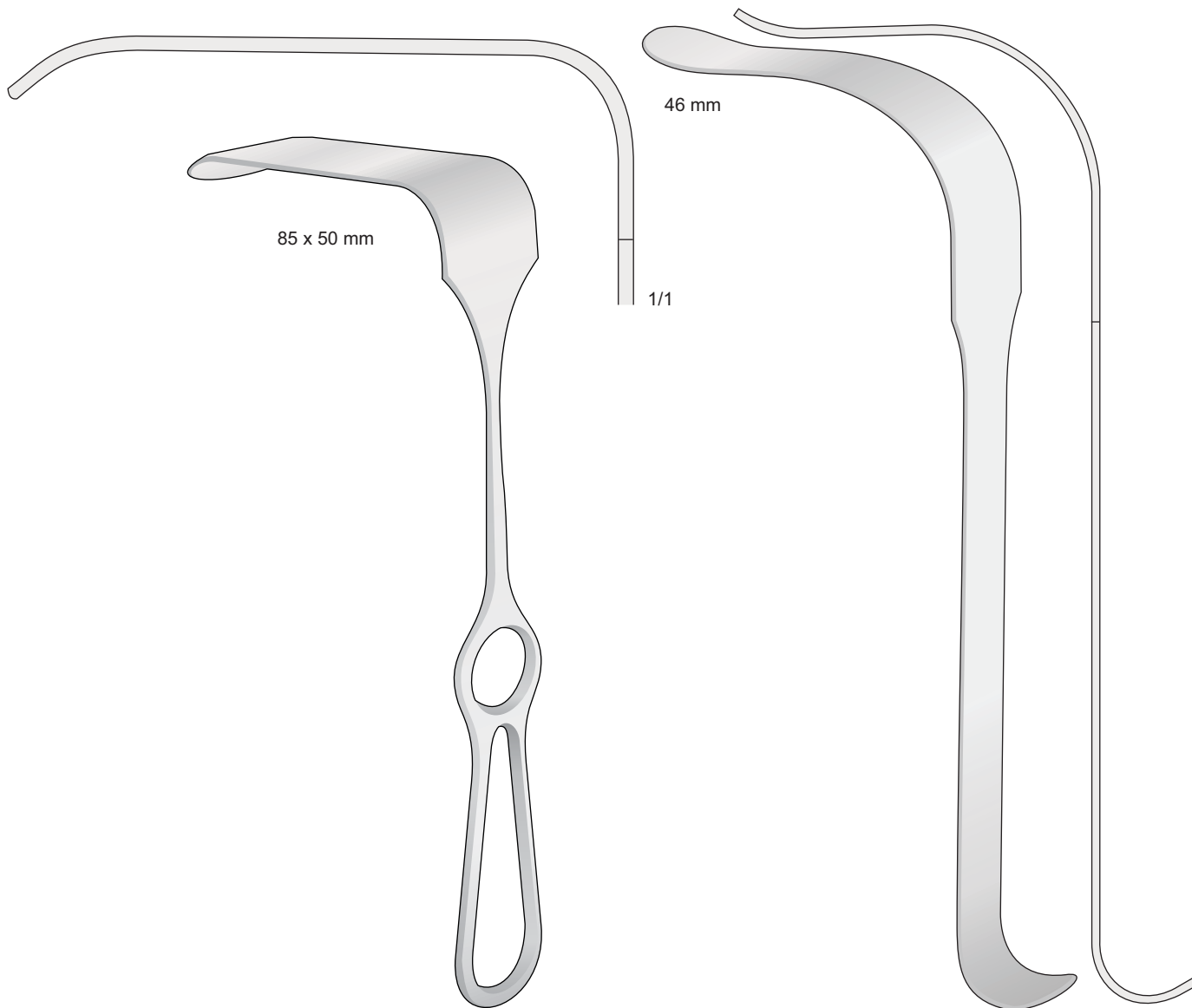

MIKULICZ
BT-31
260 mm

KOERTE
BT-274
300 mm



OM-201	7 mm + 9 mm
OM-202	11 mm + 13 mm
OM-203	15 mm + 18 mm
OM-204	18 mm + 22 mm

CUSHING
OM-201/OM-204
180 mm

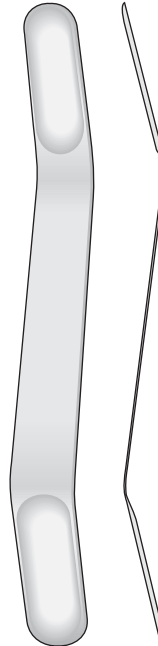

OM-208	7 mm + 9 mm
OM-209	11 mm + 13 mm
OM-210	15 mm + 18 mm
OM-211	18 mm + 22 mm

OLIVECRONA
OM-208/OM-211
180 mm

Malleabile - Malleable
Biegsam - Souple - Maleable



OM-101 30 mm
OM-102 40 mm
OM-103 50 mm
330 mm

Malleabile - Malleable
Biegsam - Souple - Maleable



HABERER
OM-104
300 mm



REVERDIN
OM-105
285 mm

Malleabile - Malleable
Biegsam - Souple - Maleable



TUFFIER
OM-99
200 mm

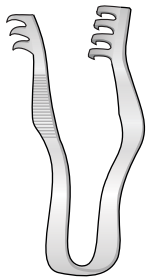

FINSEN
BV-36/BV-39
50 mm

Acuto
Sharp
Spitz
Pointù
Agudas

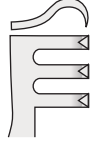

1/1

BV-36

Smusso
Blunt
Stumpf
Mousse
Romos

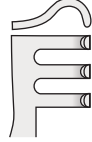

1/1

BV-37

Acuto
Sharp
Spitz
Pointù
Agudas



1/1

BV-38

Smusso
Blunt
Stumpf
Mousse
Romos

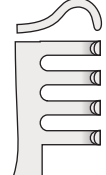

1/1

BV-39

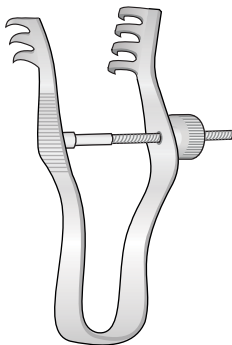

FINSEN
BV-47/BV-48
70 mm

Acuto
Sharp
Spitz
Pointù
Agudas



1/1

BV-47

Smusso
Blunt
Stumpf
Mousse
Romos



1/1

BV-48

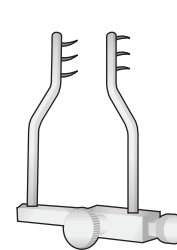

LOGAN
BV-45
40 mm

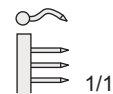

1/1

Acuto
Sharp
Spitz
Pointù
Agudas

Smusso
Blunt
Stumpf
Mousse
Romos

Smusso
Blunt
Stumpf
Mousse
Romos

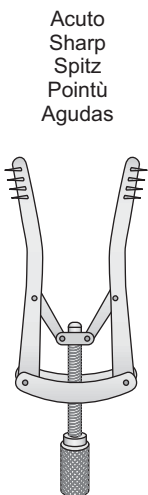

ALM
BV-12
70 mm

Acuto
Sharp
Spitz
Pointù
Agudas

Smusso
Blunt
Stumpf
Mousse
Romos

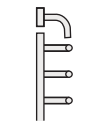

1/1

BV-49
70 mm

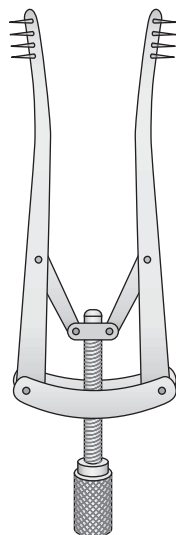

ALM
BV-10
100 mm

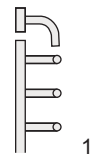

1/1

BV-51
100 mm



BV-08
100 mm

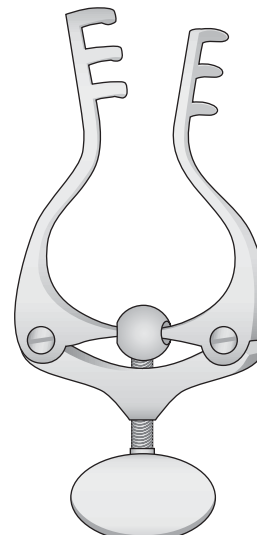

JANSEN
BV-52
100 mm



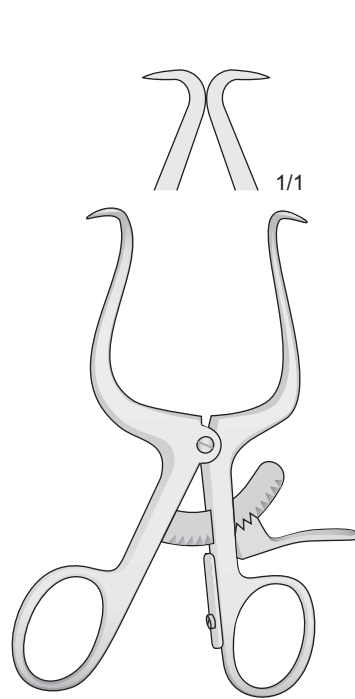

GELPI
BV-14
90 mm

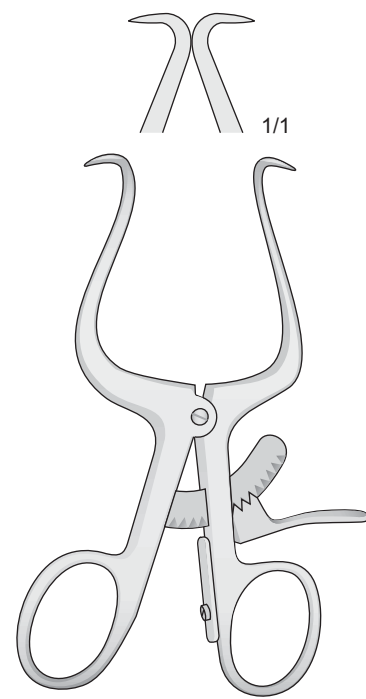

GELPI
BV-15
110 mm

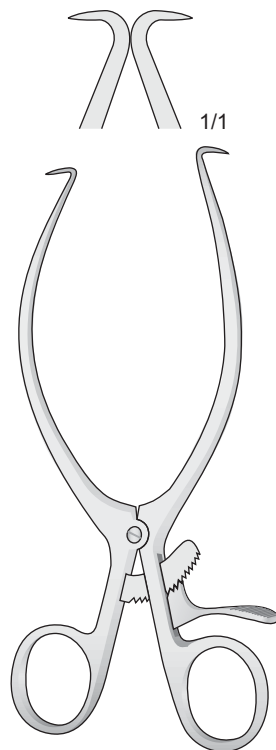

GELPI
BV-16
140 mm

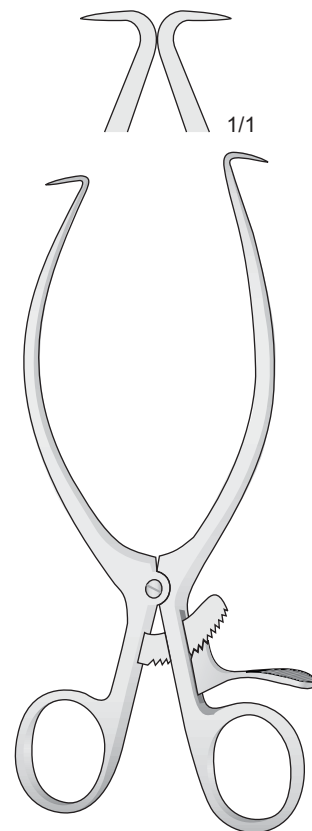

GELPI
BV-17
180 mm

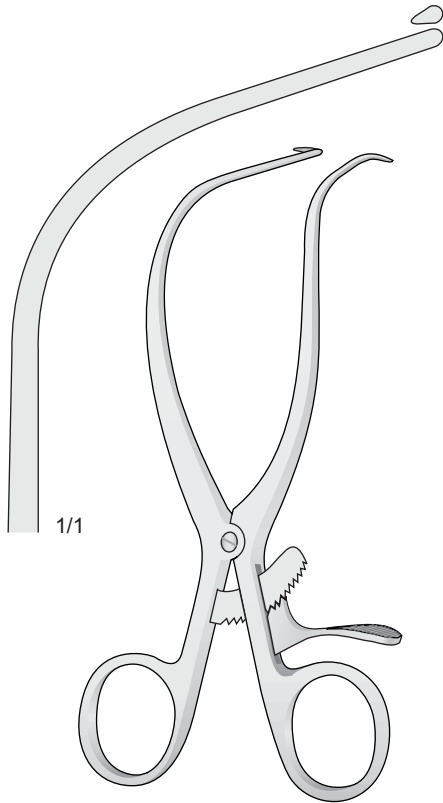

GELPI-SELETZ
BV-11
165 mm

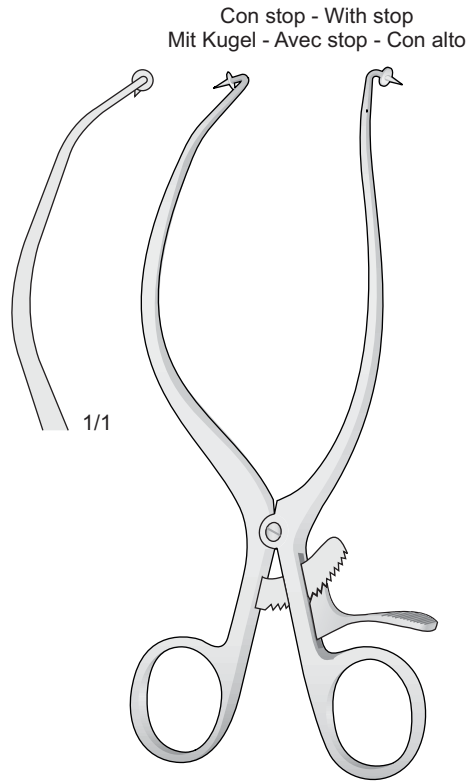

GELPI-LOKTITE
BV-13
190 mm

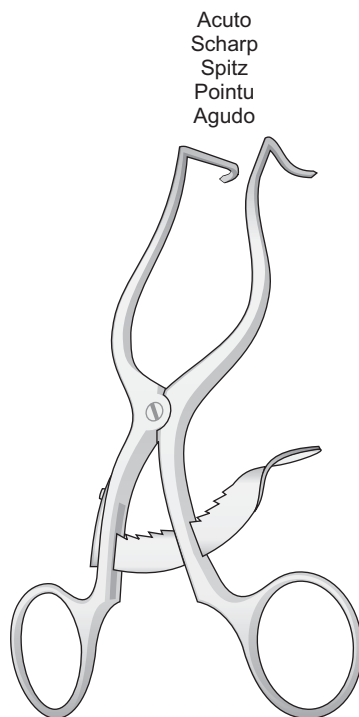

CLOWARD-CONTOUR
BV-108
140 mm

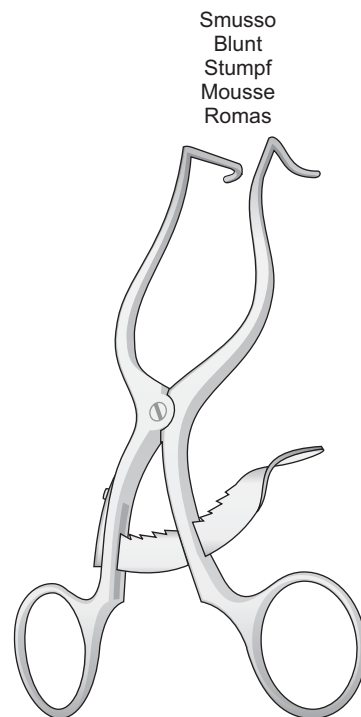

CLOWARD-CONTOUR
BV-109
140 mm

Acuto
Sharp
Spitz
Pointu
Agudo

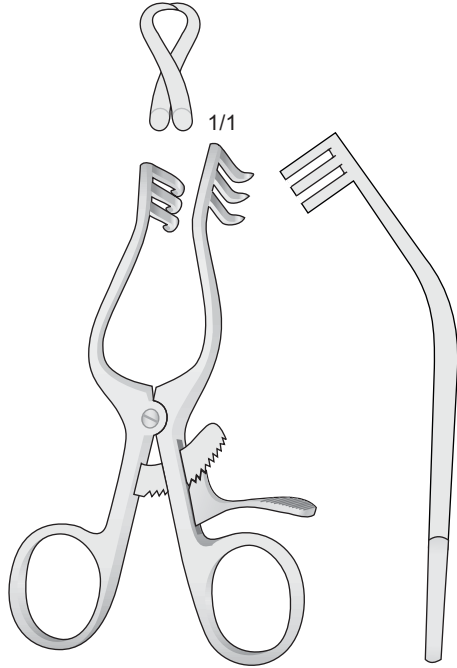

WULLSTEIN
BV-111
105 mm

Smusso
Blunt
Stumpf
Mousse
Romo

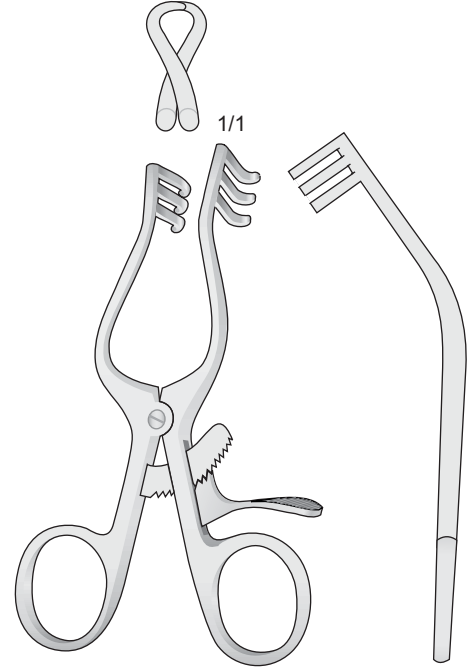

WULLSTEIN
BV-112
105 mm

Acuto
Sharp
Spitz
Pointu
Agudo

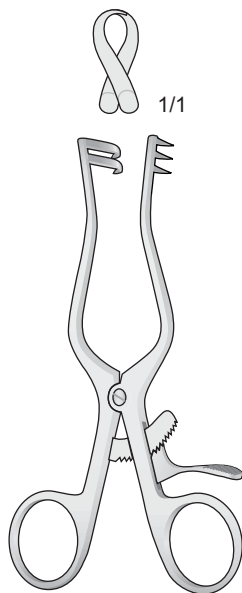

WEITLANER
BV-07
110 mm

Smusso
Blunt
Stumpf
Mousse
Romo

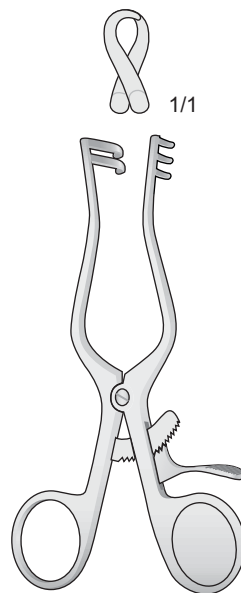

WEITLANER
BV-09
110 mm

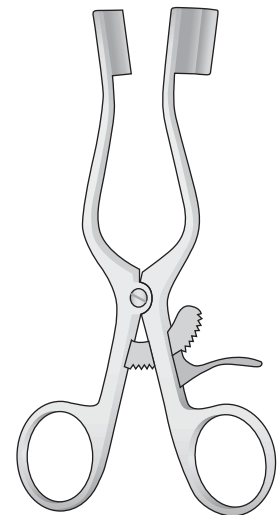
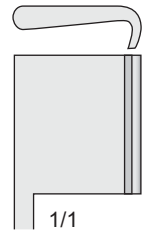

BABY-WEITLANER
BV-26
140 mm

Semi acuto - Semi Sharp - Halbscharf
Semi Pointu - Semi Agudas



1/1

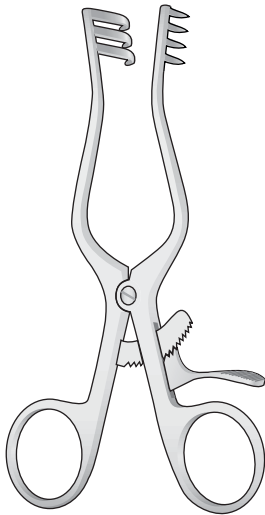

WEITLANER
BV-18
135 mm

Acuto - Sharp - Spitz
Pointu - Agudas



1/1

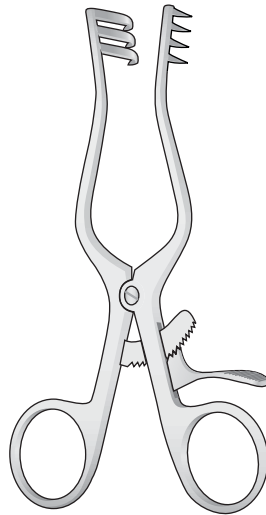

WEITLANER
BV-20
135 mm

Smusso - Blunt - Stumpf
Mousse - Romas

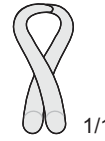

1/1

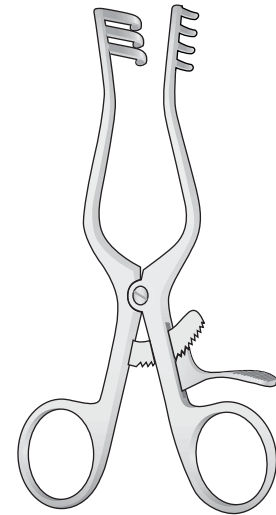

WEITLANER
BV-22
135 mm

Acuto - Sharp - Spitz
Pointu - Agudas



1/1

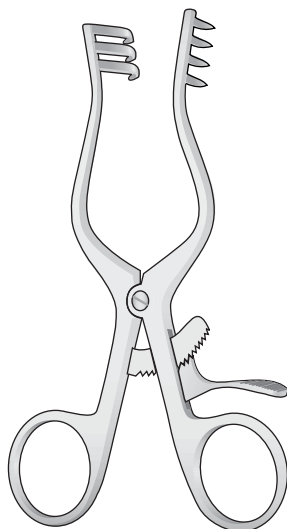

WEITLANER
BV-55
135 mm

Smusso - Blunt - Stumpf
Mousse - Romas



1/1

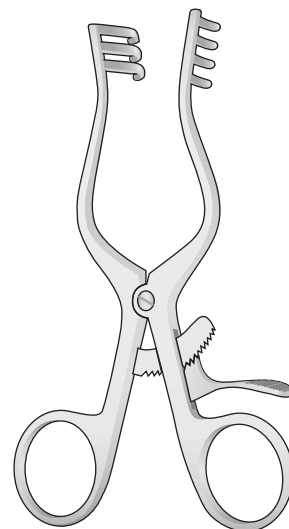

WEITLANER
BV-56
135 mm

Semi acuto - Sharp - Halbscharf
Semi Pointu - Agudas

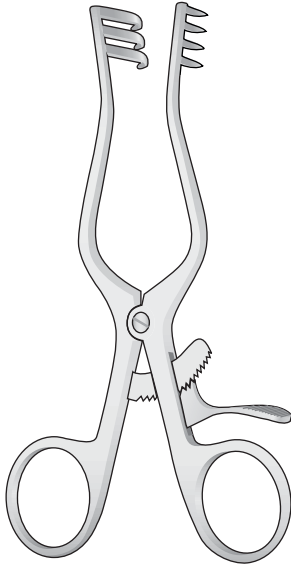

WEITLANER
BV-19
165 mm

Acuto - Sharp - Spitz
Pointu - Agudas

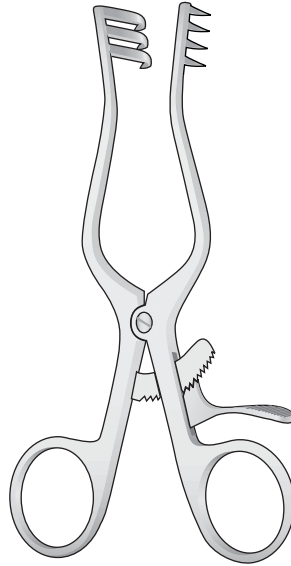

WEITLANER
BV-21
165 mm

Smusso - Blunt - Stumpf
Mousse - Romas

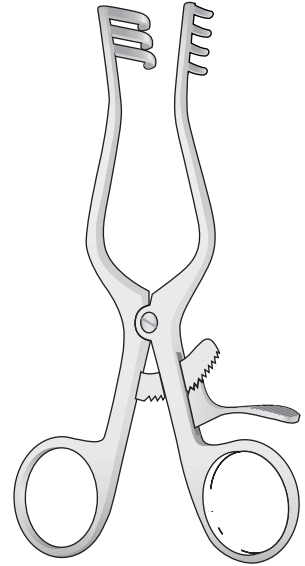

WEITLANER
BV-23
165 mm

Acuto - Sharp - Spitz
Pointu - Agudas

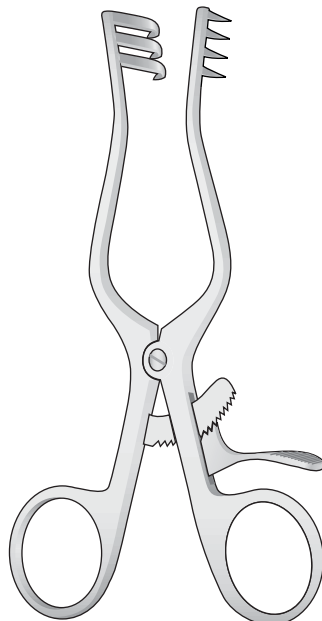

WEITLANER
BV-24
200 mm

Smusso - Blunt - Stumpf
Mousse - Romas

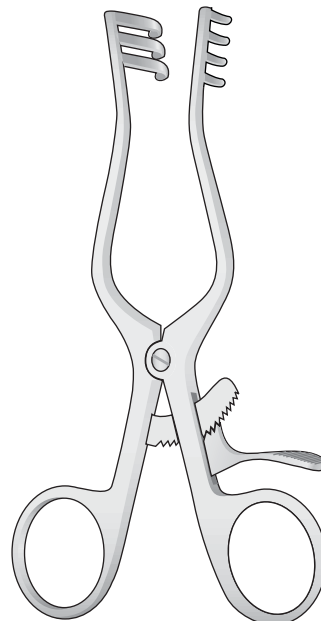

WEITLANER
BV-25
200 mm

Acuto - Sharp - Spitz
Pointu - Agudas

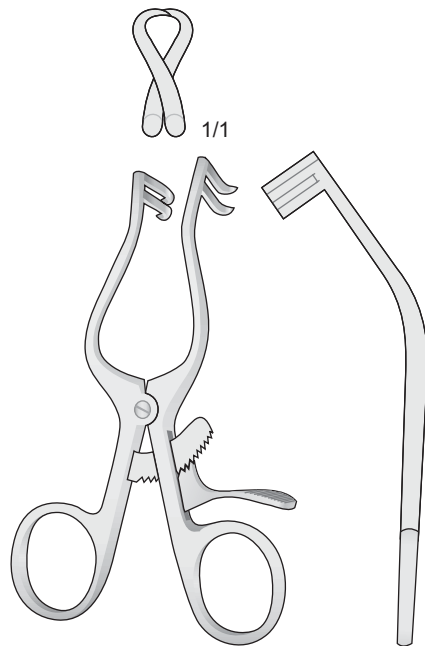

PLESTER
BV-90
110 mm

Smusso - Blunt - Stumpf
Mousse - Romas

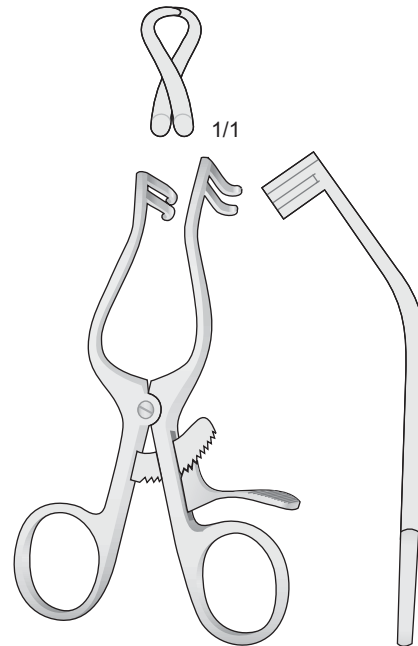

PLESTER
BV-91
110 mm

Acuto - Sharp - Spitz
Pointu - Agudas

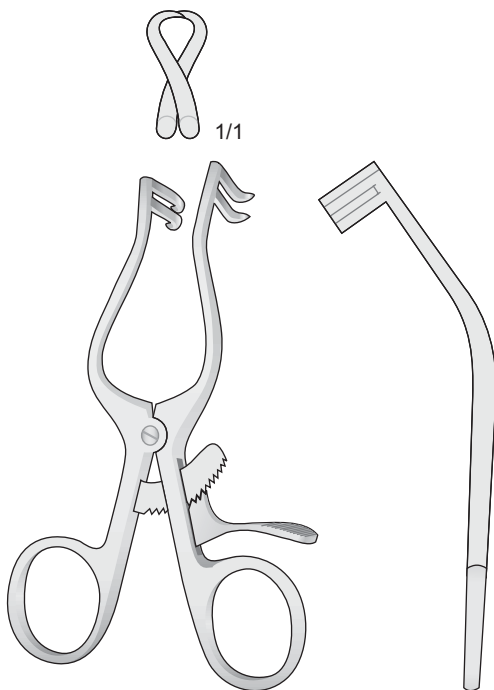

PLESTER
BV-92
135 mm

Smusso - Blunt - Stumpf
Mousse - Romas

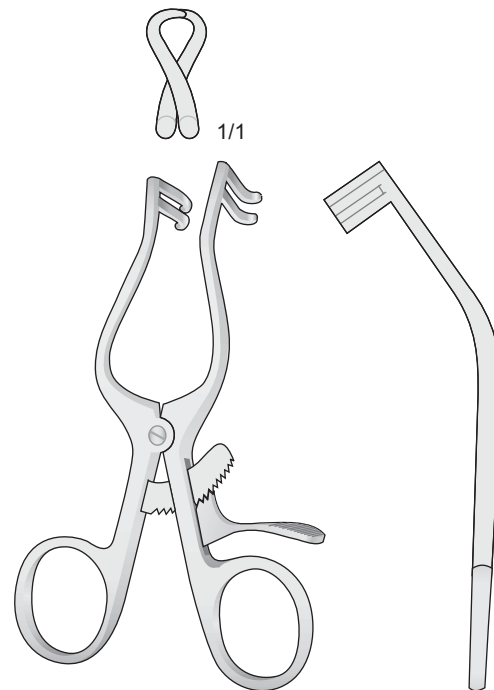

PLESTER
BV-93
135 mm

Smusso - Blunt - Stumpf - Mousse - Rome

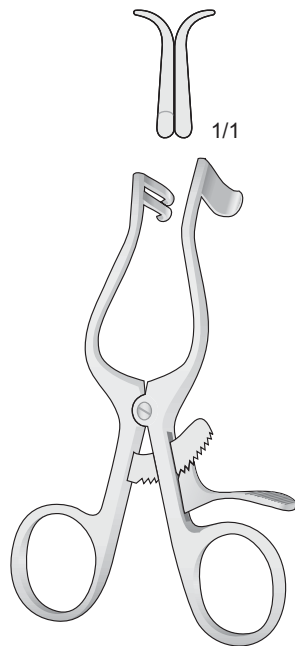

PLESTER
BV-94
110 mm

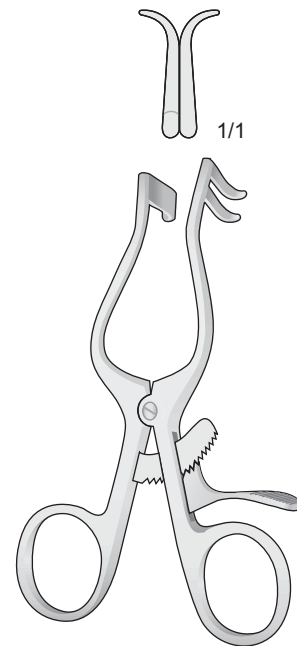

PLESTER
BV-95
110 mm

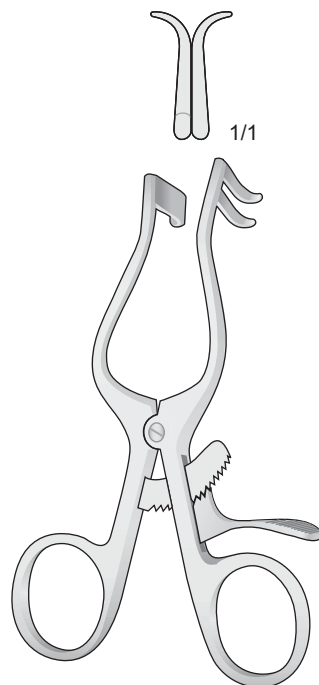

PLESTER
BV-96
135 mm

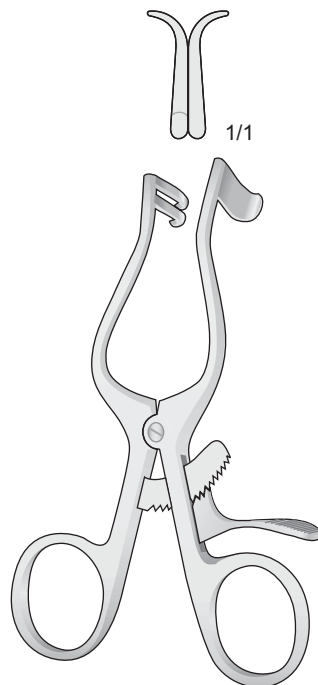

PLESTER
BV-97
135 mm

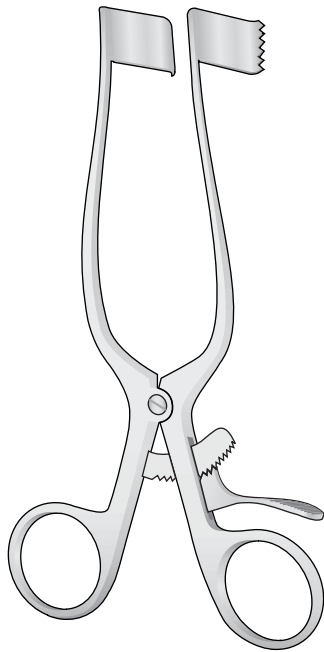

MEYERDING
BV-76 - 32 x 25 mm
BV-77 - 60 x 25 mm
BV-78 - 54 x 25 mm
BV-79 - 60 x 20 mm
180 mm

Acuto - Sharp - Spitz
Pointu - Agudo

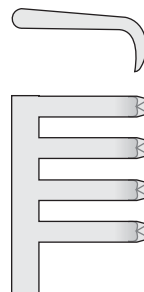

BV-117

Smusso - Blunt - Stumpf
Mousse - Rome

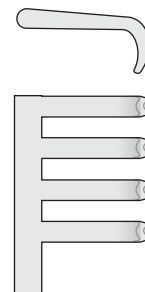

BV-118

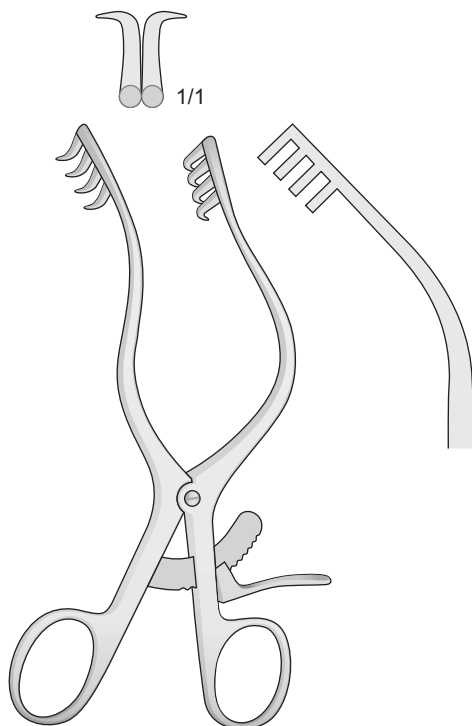

MOLLISON
BV-110

160 mm

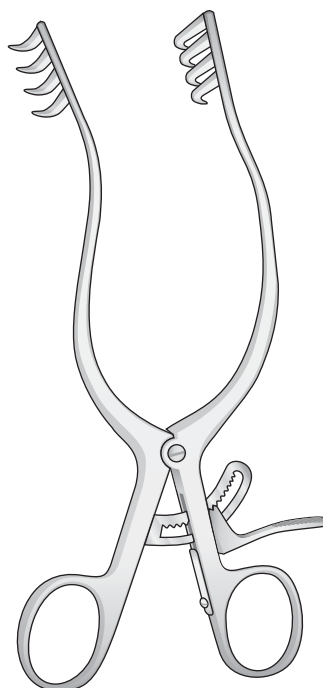

ANDERSON-ADSON
BV-117/BV-118

200 mm



WALTON
BV-88
180 mm

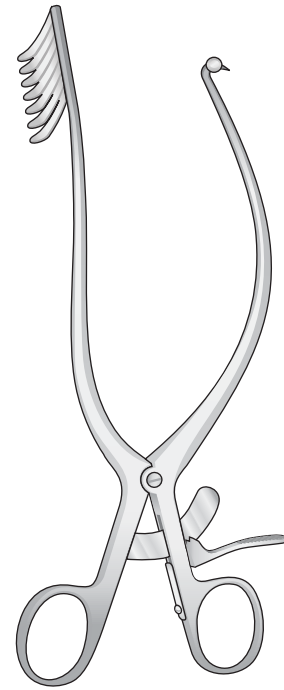

WALTON
BV-89
180 mm

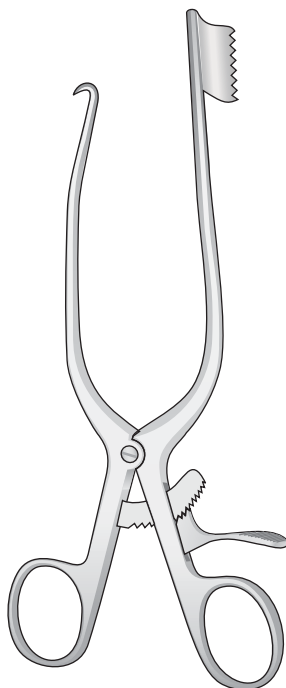

MARKHAM-MEYERDING
BV-98
180 mm

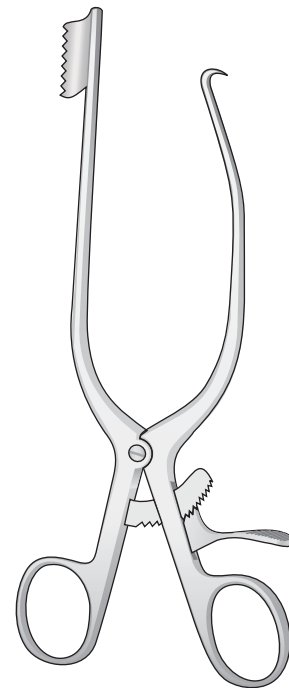

MARKHAM-MEYERDING
BV-99
180 mm

09



Acuto - Sharp - Spitz
Pointu - Agudo

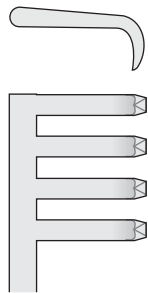

BV-119

Smusso - Blunt - Stumpf
Mousse - Rome

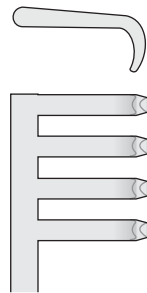

BV-120

4 x 4 Denti
4 x 4 Teeth
4 x 4 Zähne
4 x 4 Dents
4 x 4 Dientes

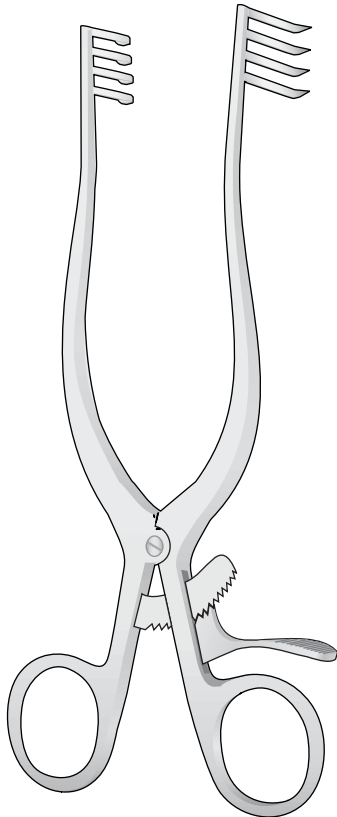

**ADSON
BV-119/BV-120**
200 mm

Acuto - Sharp - Spitz
Pointu - Agudo

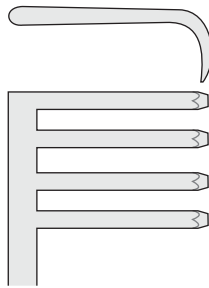

BV-27

Smusso - Blunt - Stumpf
Mousse - Rome

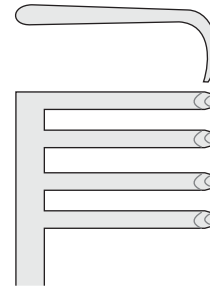

BV-28

4 x 4 Denti
4 x 4 Teeth
4 x 4 Zähne
4 x 4 Dents
4 x 4 Dientes

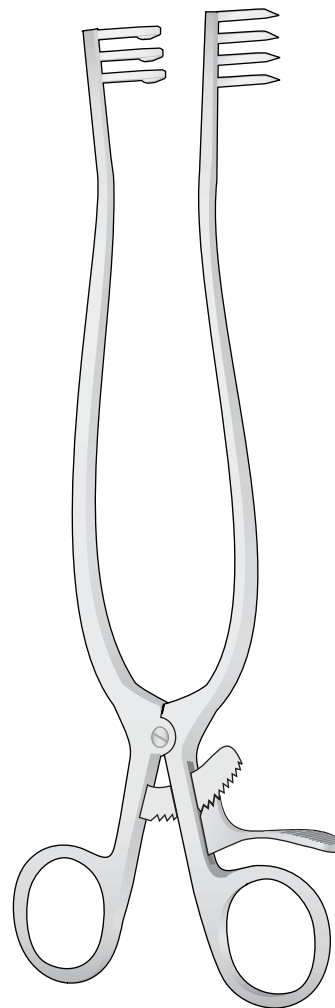

**WEITLANER
BV-27/BV-28**
250 mm

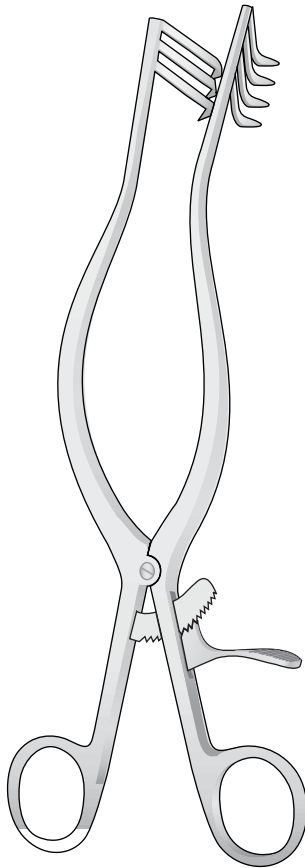

ADSON
BV-190/BV-193
265 mm

3 x 4 Denti
3 x 4 Teeth
3 x 4 Zähne
3 x 4 Dents
3 x 4 Dientes

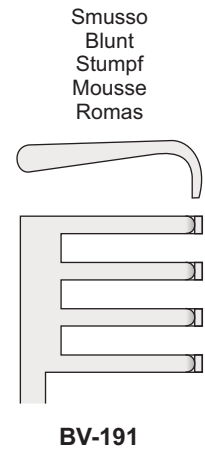
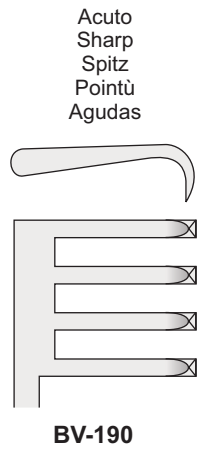

6 x 6 Denti
6 x 6 Teeth
6 x 6 Zähne
6 x 6 Dents
6 x 6 Dientes

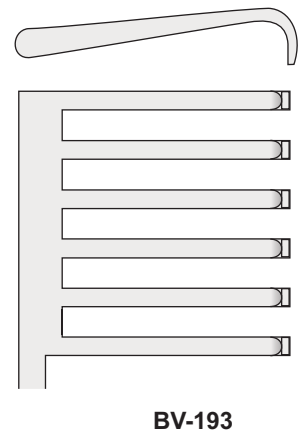
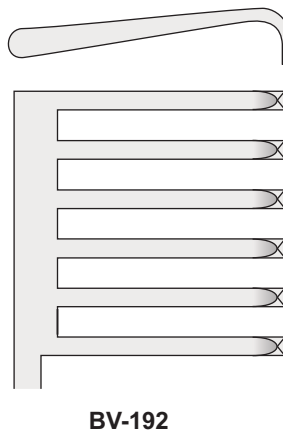

Acuto - Sharp - Spitz
Pointu - Agudo

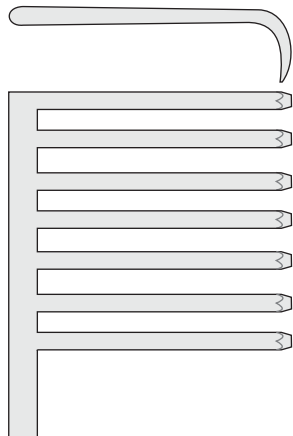

BV-130
220 mm

Smusso - Blunt - Stumpf
Mousse - Rome

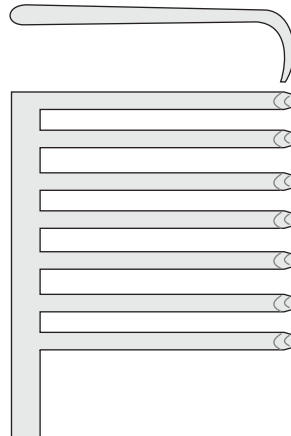

BV-131
220 mm

7 x 7 Denti
7 x 7 Teeth
7 x 7 Zähne
7 x 7 Dents
7 x 7 Dientes

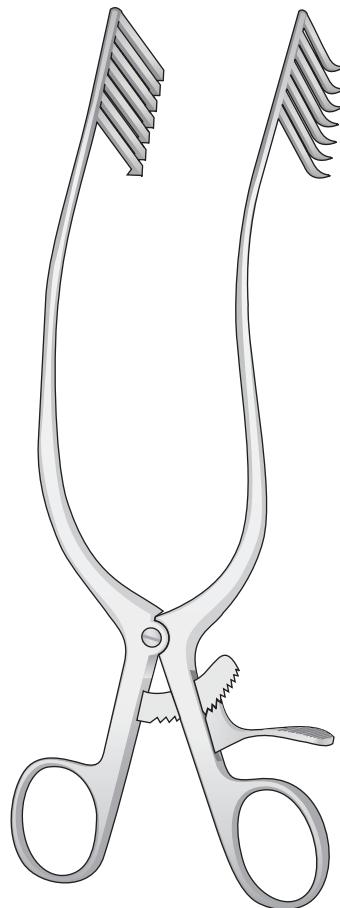

MISKIMON
BV-130/BV-131

220 mm

Acuto
Scharp
Spitz
Pointu
Agudo

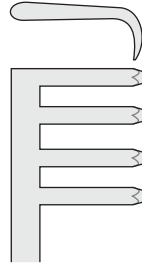

BV-68
140 mm

Smusso
Blunt
Stumpf
Mousse
Romos

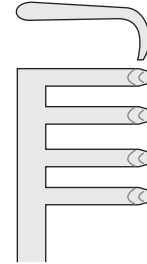

BV-70
140 mm

3 x 4 Denti
3 x 4 Teeth
3 x 4 Zähne
3 x 4 Dents
3 x 4 Dientes

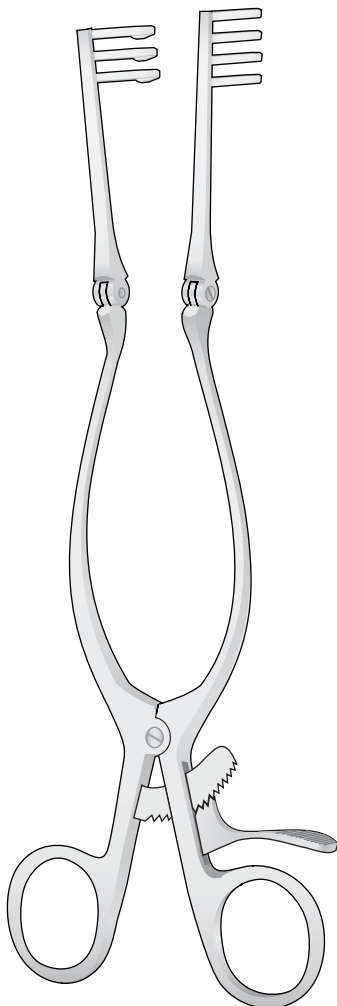

ADSON
BV-68/BV-75

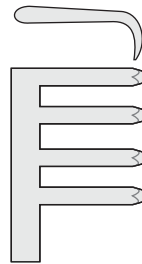

BV-69
165 mm

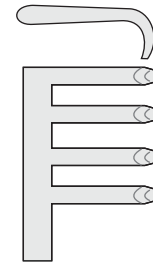

BV-71
165 mm

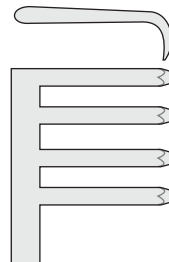

BV-72
200 mm

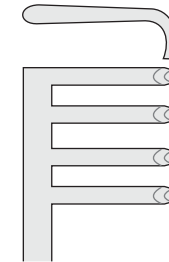

BV-73
200 mm

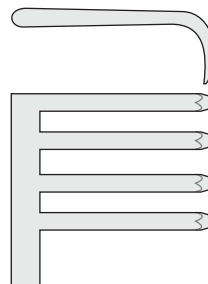

BV-74
250 mm

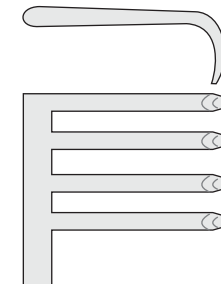

BV-75
250 mm

Acuto - Sharp
Spitz - Pointü
Agudas

- 4 x 4 Denti
- 4 x 4 Teeth
- 4 x 4 Zähne
- 4 x 4 Dents
- 4 x 4 Dientes

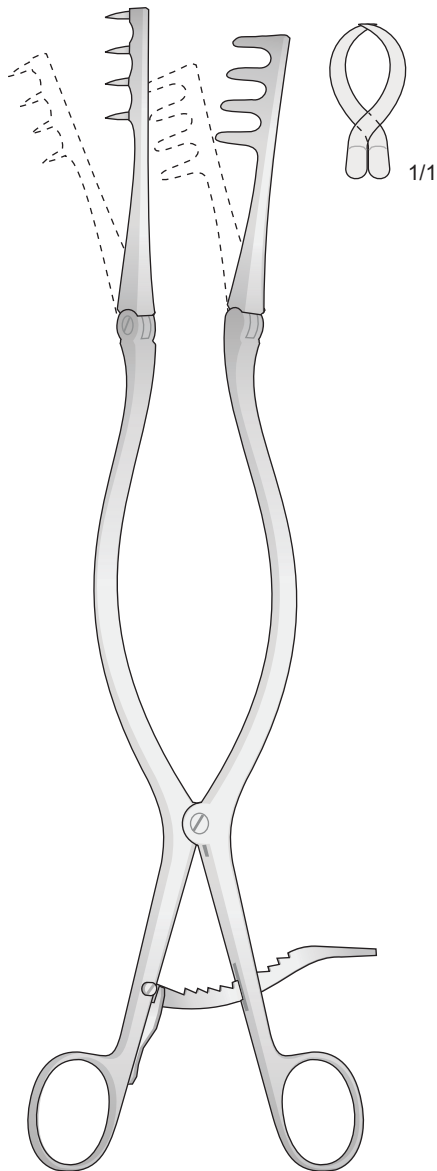

BECKMANN
BV-121
310 mm

Semi acuto -Sharp
Halbscharf - Semi pointü
Agudas

- 4 x 4 Denti
- 4 x 4 Teeth
- 4 x 4 Zähne
- 4 x 4 Dents
- 4 x 4 Dientes

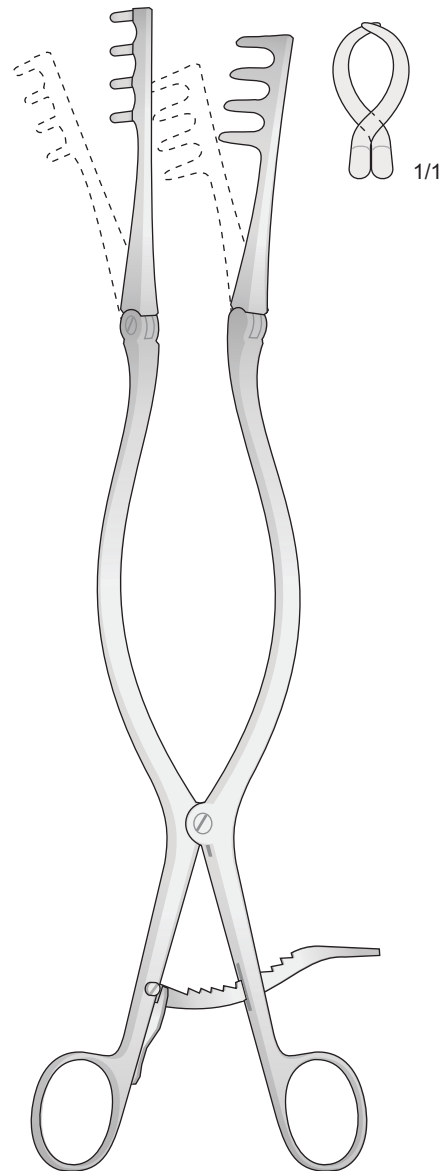

BECKMANN
BV-122
310 mm

Smusso - Blunt - Stumpf
Mousse - Romas

5 x 4 Denti
5 x 4 Teeth
5 x 4 Zähne
5 x 4 Dents
5 x 4 Dientes

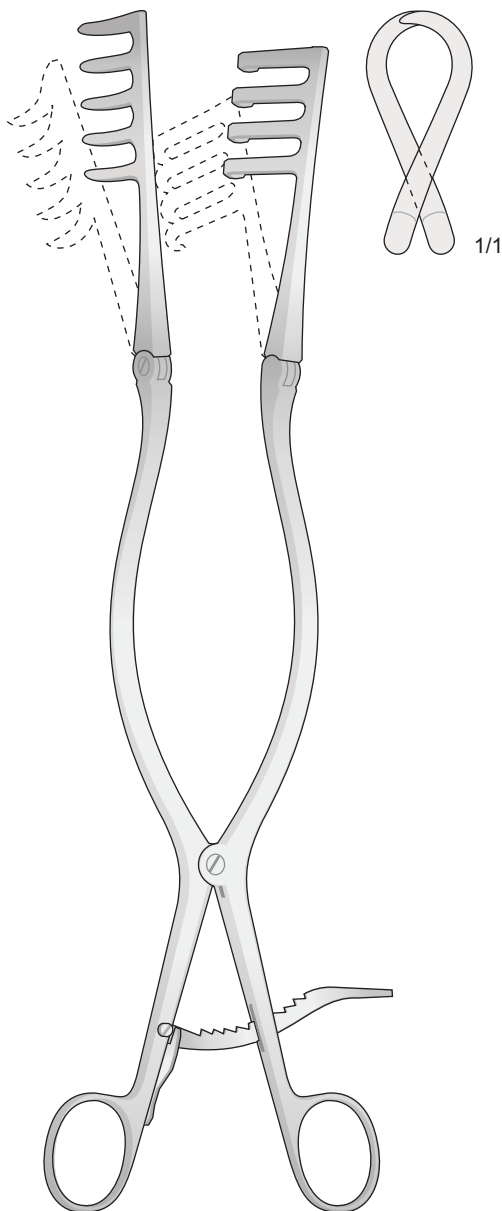

ADSON
BV-123
320 mm

Acuto-Sharp-Spitz
Pointü-Agudas

7 x 7 Denti
7 x 7 Teeth
7 x 7 Zähne
7 x 7 Dents
7 x 7 Dientes

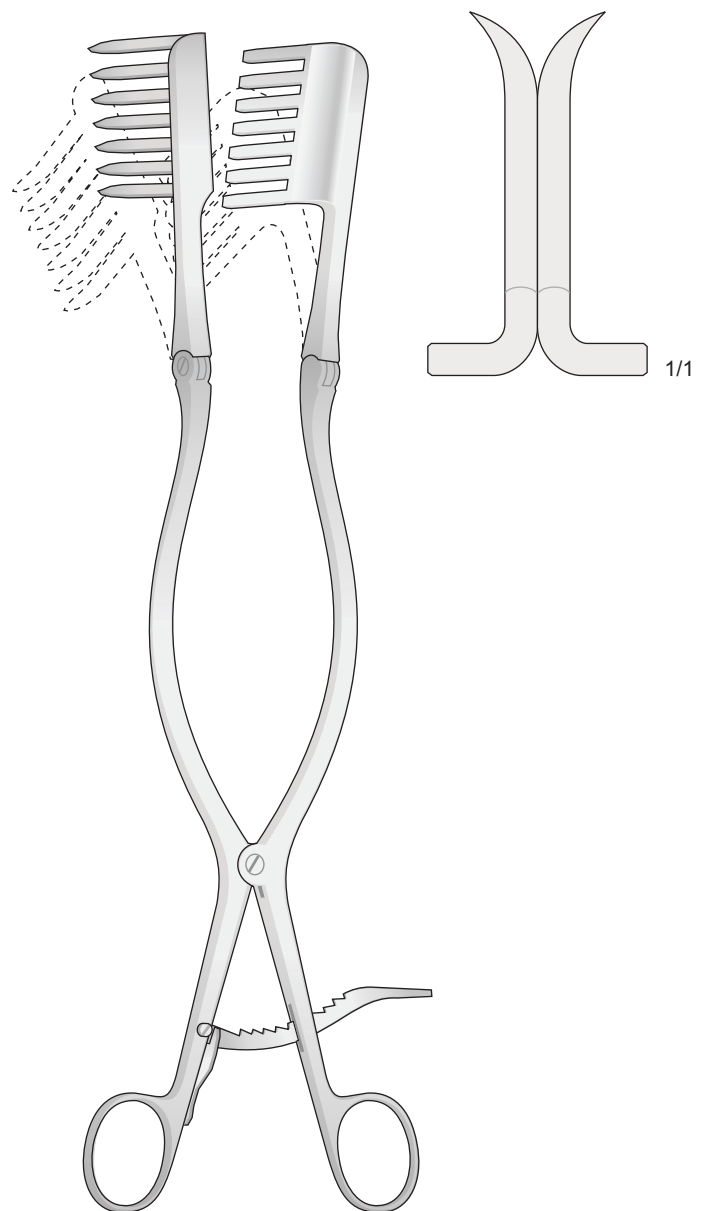

BECKMANN-EATON
BV-124
330 mm

Solo divaricatore senza valva
 Retractor without blades
 Spreizer allein
 Separador sin valvas
 Ecarteur sans valves

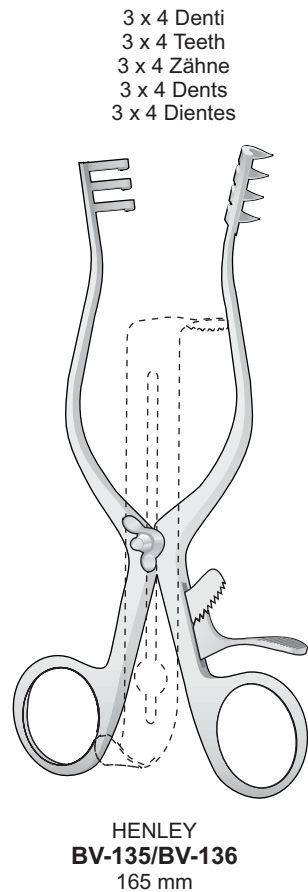
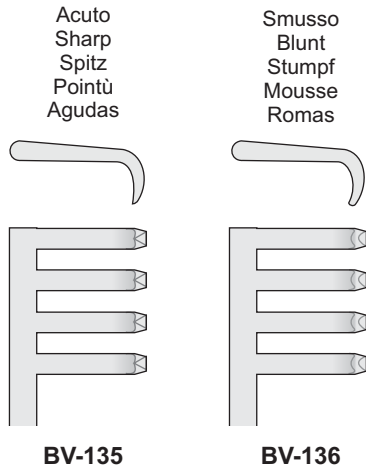

Valve centrali
 Center blades
 Mittelblatte
 Valves centrale
 Valvas centrales

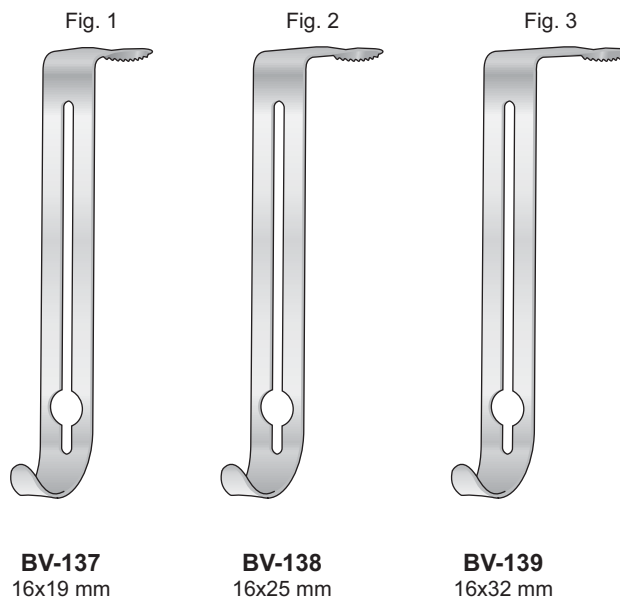

CLOWARD Modif.
BV-319
Divaricatore, solo
Retractor, only
Sperrer, allein
Ecarteur, seul
Separador, suelto

CLOWARD Modif.
BV-317
Divaricatore, solo
Retractor, only
Sperrer, allein
Ecarteur, seul
Separador, suelto

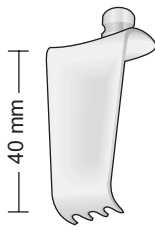

BV-321

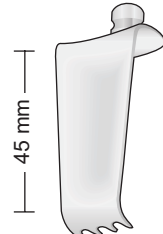

BV-322



BV-326

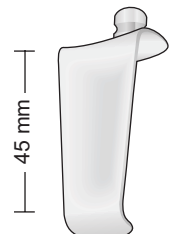

BV-327

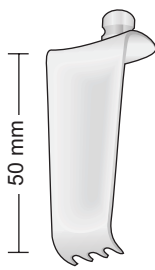

BV-323

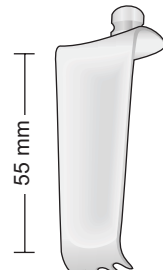

BV-324

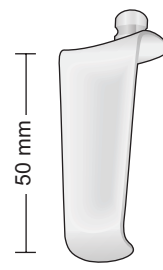

BV-328

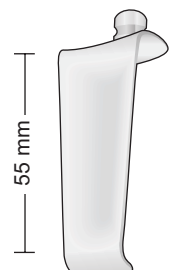

BV-329

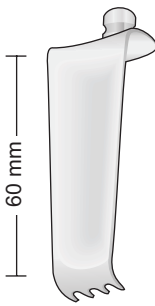

BV-325

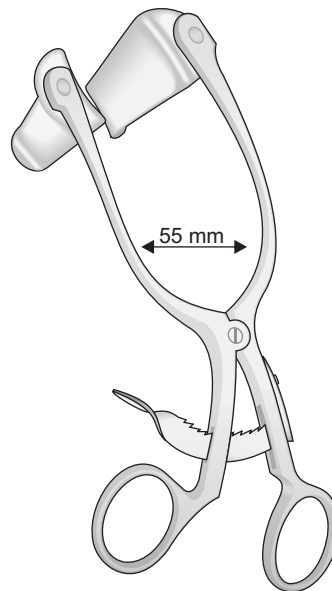

CLOWARD
BV-318
160 mm

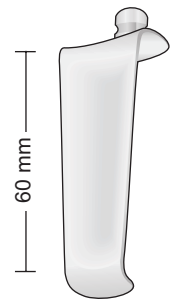

BV-330

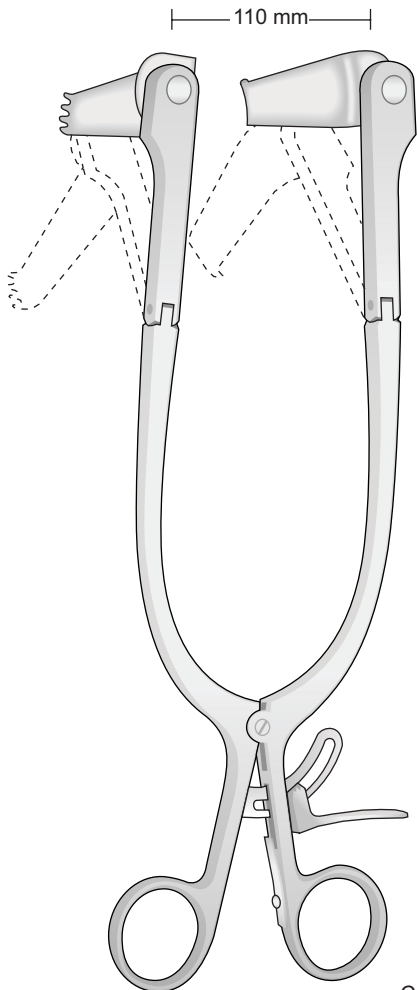

CLOWARD modif.
BV-320
250 mm

Completo di 5 valve
Complete with 5 blades
Komplett mit 5 Valven
Complet avec 5 valves
Completo con 5 valvas

Completo di 5 valve
Complete with 5 blades
Komplett mit 5 Valven
Complet avec 5 valves
Completo con 5 valvas

BV-141

Completo con un paio di valve
Complete with 1 pairs of blades
Komplett mit 1 Paar Valven
Complete avec 1 paires de valves
Completo con 1 pares de valvas

BV-146

Completo con due paia di valve
Complete with 2 pairs of blades
Komplett mit 2 paar valven
Complete avec 2 paires de valves
Completo con 2 pares de valvas

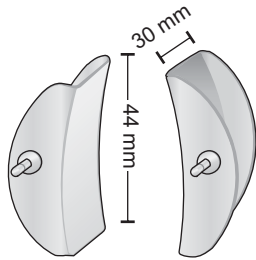

BV-142 20x44 mm

BV-143 30x44 mm

Valve laterali - paia
Lateral blades - pairs
Seitl. Blätter - paar
Valves latérales - paires
Valvas laterales - pares

BV-145

Completo con un paio di valve
Complete with 1 pairs of blades
Komplett mit 1 Paar Valven
Complete avec 1 paires de valves
Completo con 1 pares de valvas

BV-148

Divaricatore solo
Retractor only
Sperrer allein
Ecarteur seul
Separador suelto

BV-372

32x62 mm

Valve laterali - paia
Lateral blades - pairs
Seitl.blätter - paar
Valves latérales - paires
Valvas laterales - pares

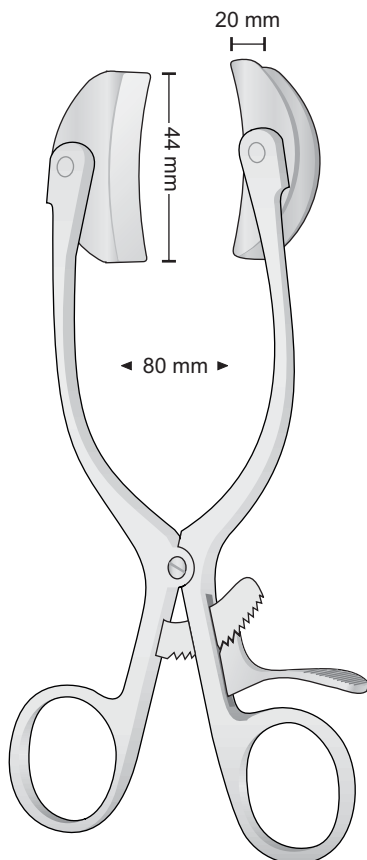

BABY-COLLIN
BV-141
180 mm

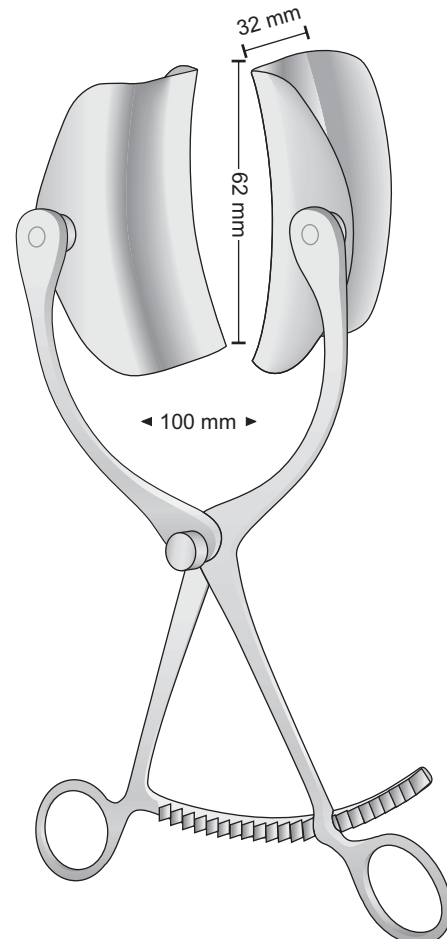

COLLIN
BV-145
220 mm

**COLLIN
BV-380**
Completo - Complete
Komplett - Complets - Completos
BV-378 ÷ BV-375 ÷ BV-372

**COLLIN
BV-381**
Completo - Complete
Komplett - Complets - Completos
BV-379 ÷ BV-376 ÷ BV-373

**COLLIN
BV-382**
Completo - Complete
Komplett - Complets - Completos
BV-379 ÷ BV-377 ÷ BV-374

BV-378
Allargatore solo
Spreader only
Sperrer allein
Ecarteur seul
Separador suelto

BV-379
Allargatore solo
Spreader only
Sperrer allein
Ecarteur seul
Separador suelto

BV-379
Allargatore solo
Spreader only
Sperrer allein
Ecarteur seul
Separador suelto

BV-375
Valva centrale
Center blade
Mittelblatt
Valve centrale
Valva central
55 x 55 mm

BV-376
Valva centrale
Center blade
Mittelblatt
Valve centrale
Valva central
55 x 65 mm

BV-377
Valva centrale
Center blade
Mittelblatt
Valve centrale
Valva central
55 x 75 mm

BV-372
Valve laterali
Lateral blades
Seitliche Blätter
Valves latérales
Valvas laterales
32 x 62 mm

BV-373
Valve laterali
Lateral blade
Seitliche Blätter
Valves latérales
Valvas laterales
38 x 80 mm

BV-374
Valve laterali
Lateral blade
Seitliche Blätter
Valves latérales
Valvas laterales
38 x 100 mm

Completo - Complete
Komplett - Complets - Completos

BV-378 - 135 mm
BV-379 - 160 mm

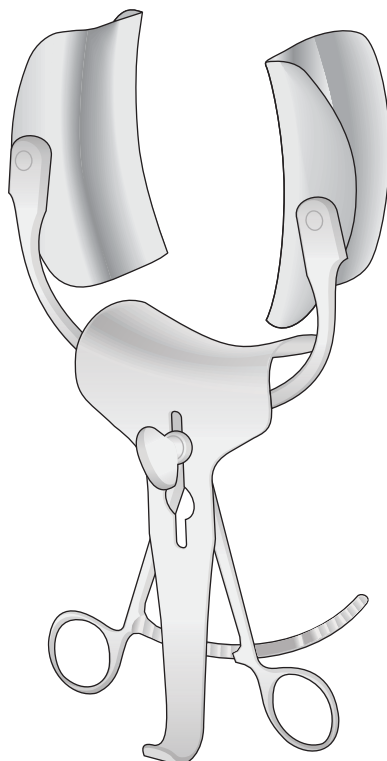

COLLIN
BV-380 - BV-381 - BV-382

Unità di vendita delle valve: paio
Sales Unit of blades: pair
Bestelleinheit der Blätter: Paar
Unité de commande pour les valves: paire

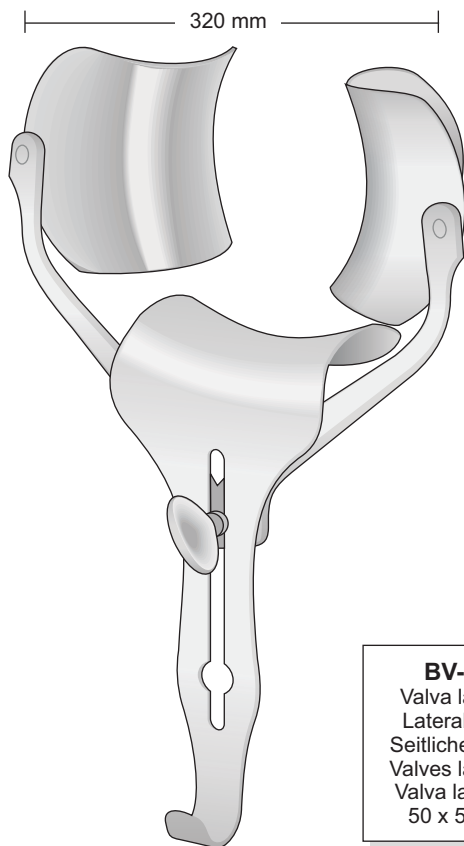

**RICARD
BV-199**
Completo - Complete
Komplett - Complet - Completo
BV-194 + BV-195 + BV-197

**RICARD
BV-200**
Completo - Complete
Komplett - Complet - Completo
BV-194 + BV-196 + BV-198

BV-194
Divaricatore solo
Retractor only
Sperrer allein
Ecarteur seul
Separador suelto

BV-195
Valva centrale
Center blade
Mittelblatt
Valve centrale
Valva central
55 x 70 mm

BV-196
Valva centrale
Center blade
Mittelblatt
Valve centrale
Valva central
80 x 90 mm

BV-183
Valva laterale
Lateral blade
Seitliche Blätter
Valves latérales
Valva laterales
50 x 58 mm

BV-197
Valva laterale
Lateral blade
Seitliche Blätter
Valves latérales
Valva laterales
60 x 80 mm

BV-198
Valva laterale
Lateral blade
Seitliche Blätter
Valves latérales
Valva laterales
72 x 85 mm

RICARD
BV-199 Completo - Complete
Komplett - Complet - Completo
BV-200 Completo - Complete
Komplett - Complet - Completo

Completo - Complete
Komplett - Complete - Completos

Unità di vendita delle valve: paio
Sales Unit of blades: pair
Bestelleinheit der Blätter: Paar
Unité de commande pour les valves: paire

BV-162
Divaricatore solo
Retractor only
Sperrer allein
Ecarteur seul
Separador suelto

BV-159
59 x 80 mm
Valve laterali
Lateral blades
Seitliche Blätter
Valves latérales
Valvas laterales

BV-144
74 x 82 mm
Valva centrale
Center blade
Mittelblatt
Valve centrale
Valva central

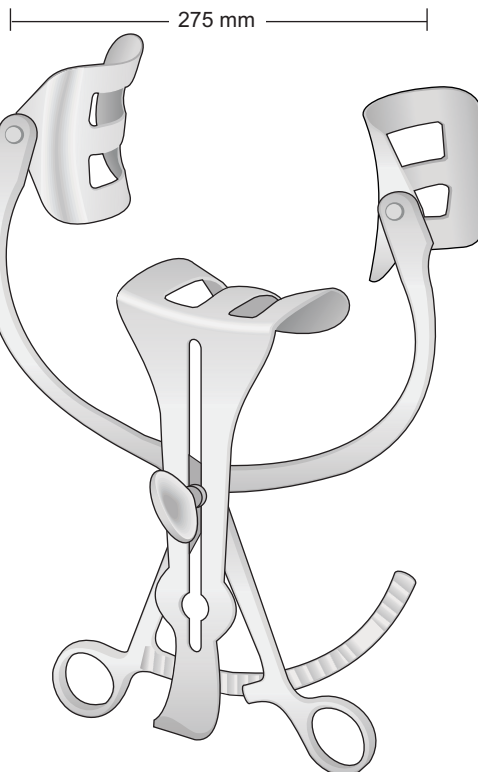

**HOLZBACH
BV-158**

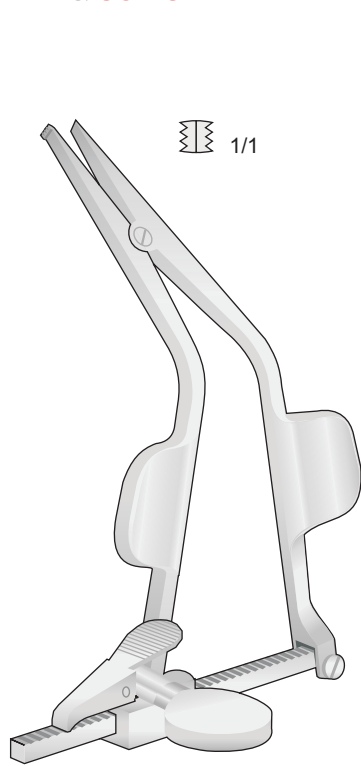

CLOWARD
BV-86
150 mm

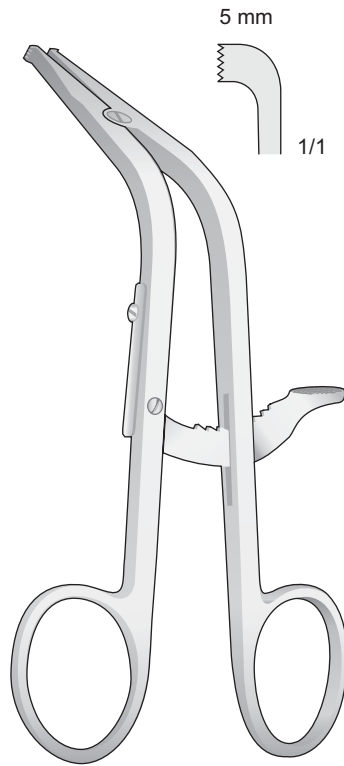

CLOWARD
BV-84
160 mm

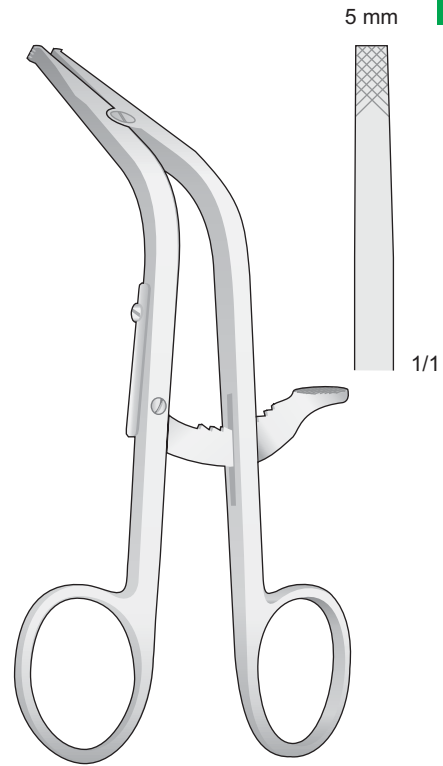

CLOWARD
BV-85
160 mm

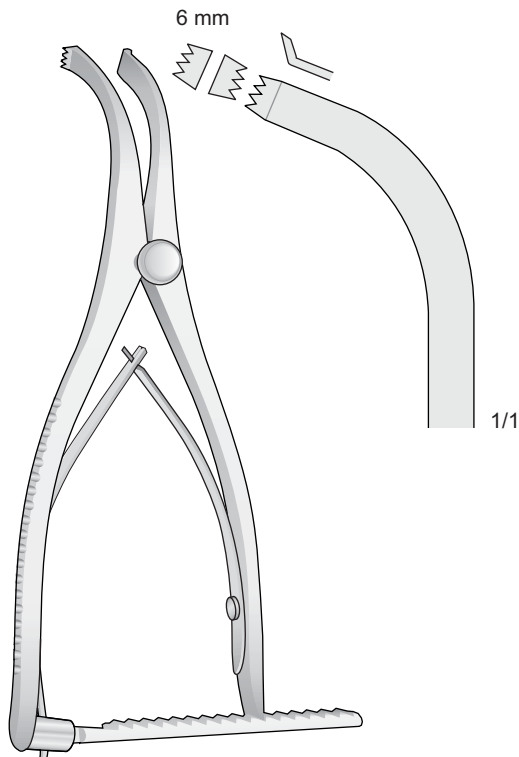

INGE
BV-80
160 mm

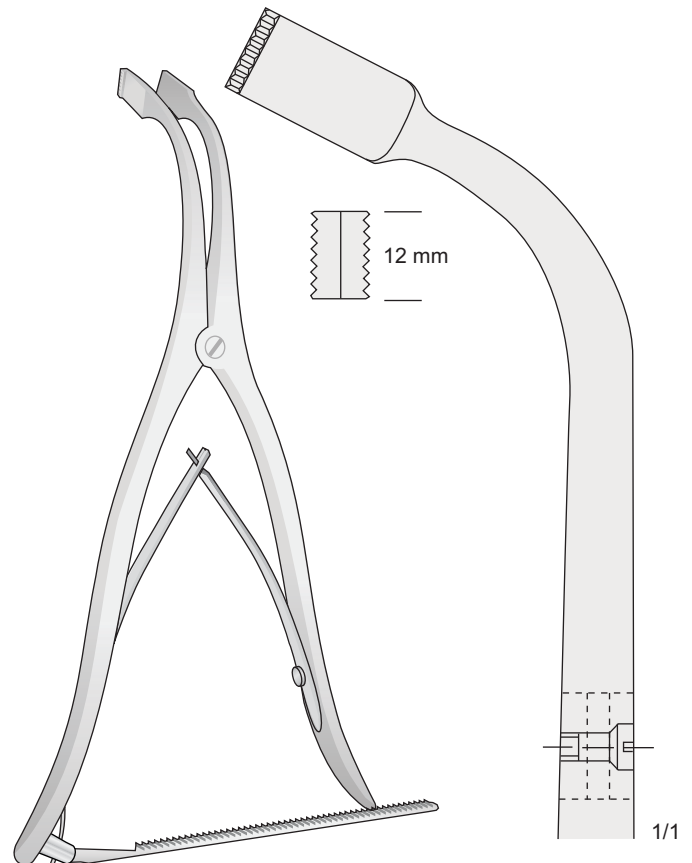

INGE
BV-82
275 mm

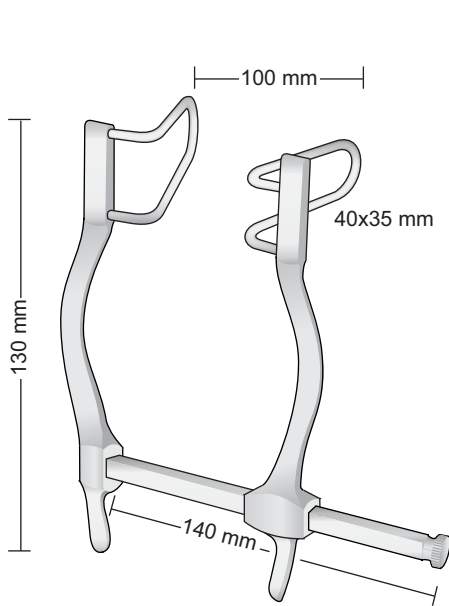

**GOSSET
BV-31**

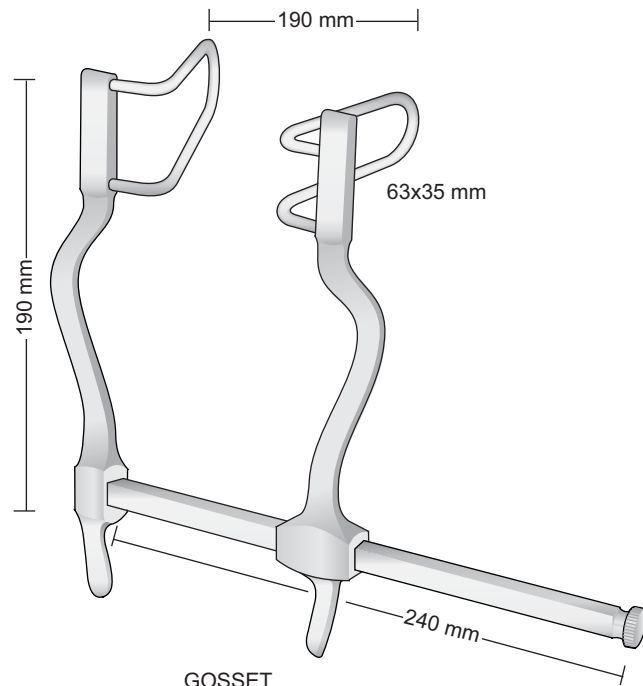

**GOSSET
BV-30**

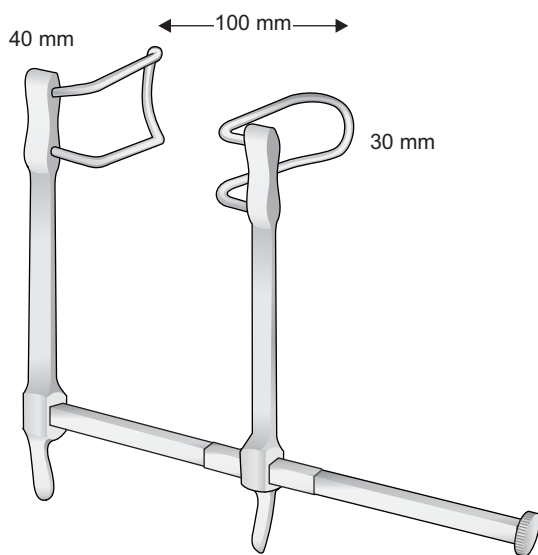

**GOSSET
BV-33**

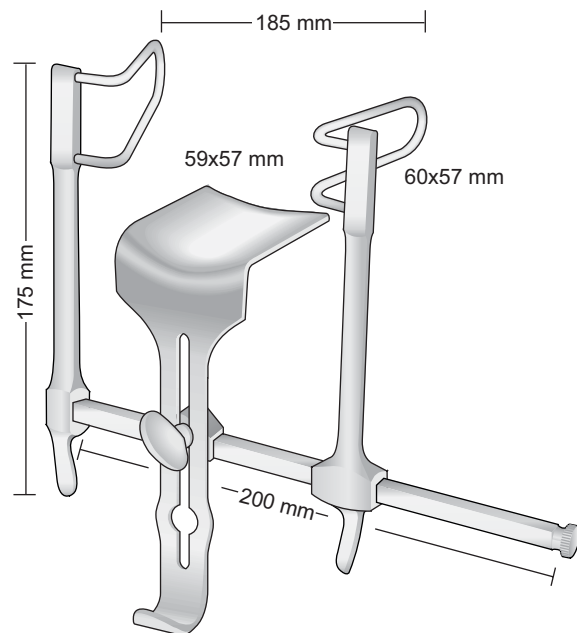

**GOSSET
BV-32**

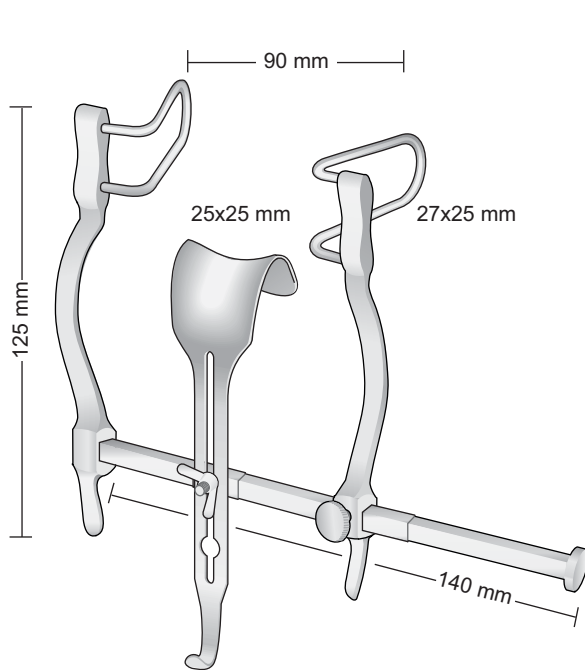

**BALFOUR-BABY
BV-41**

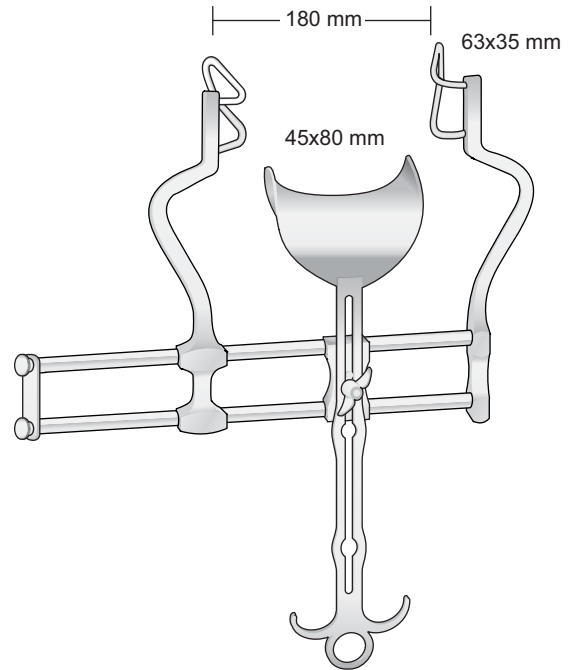

**BALFOUR
BV-40**

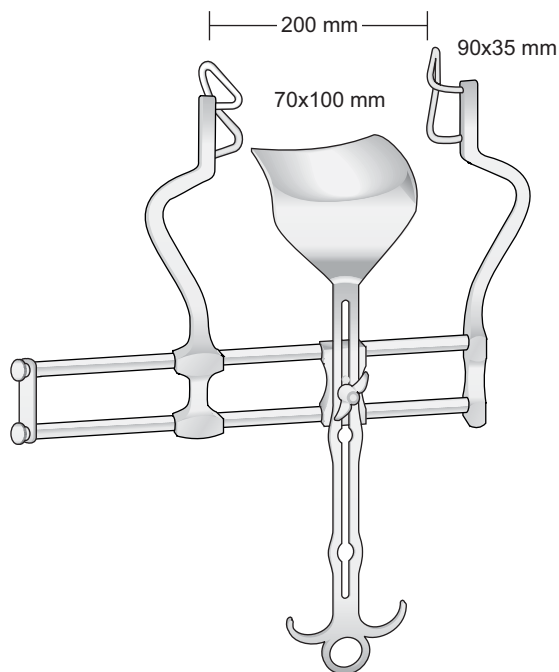

**BALFOUR
BV-42**

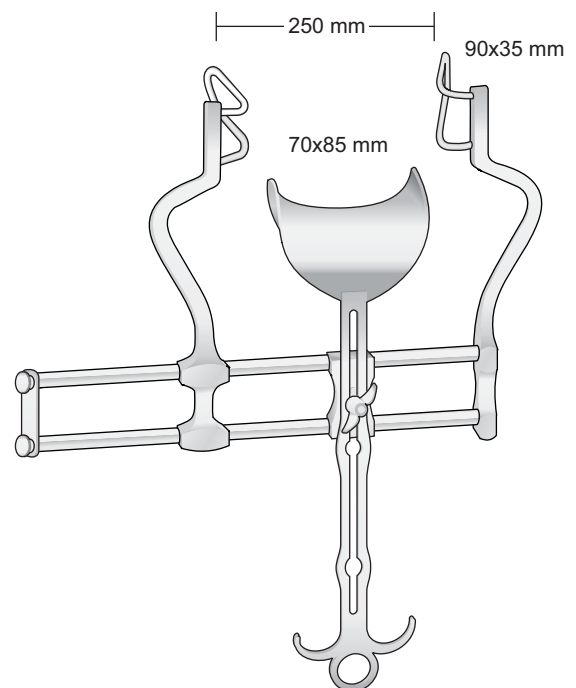

**BALFOUR
BV-43**

Valva centrale - Center blade
Mittelblatt - Valve centrale - Valva central

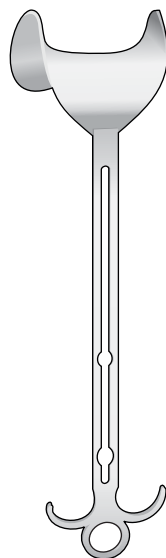

BALFOUR
BV-153
45 x 80 mm

Valve laterali - paio
Lateral blades - pair
Seitliche Blätter - Paar
Valves latérales - paires
Valvas laterales - pares

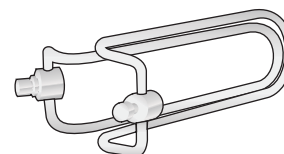

BV-186 - 50 mm
BV-187 - 60 mm
BV-188 - 75 mm
BV-189 - 90 mm

BV-184
Completo con:
Complete with:
Komplett mit:
Complet avec:
Completo con:
BV-185 - BV-153 - BV-186

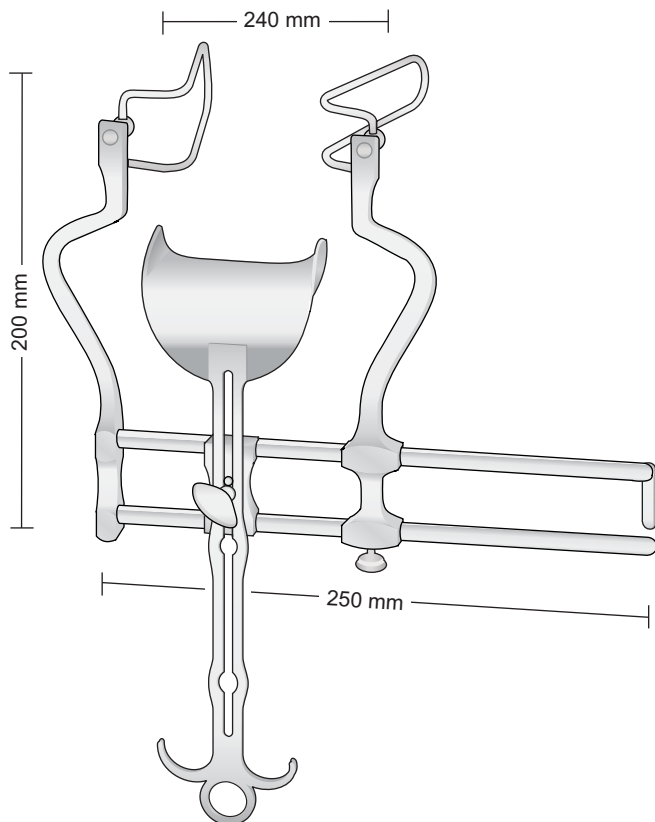

BALFOUR
BV-184

BV-185
BALFOUR
Divaricatore solo
Retractor only
Sperrer allein
Ecarteur seul
Separador suelto

BV-153
Valva centrale
Center blade
Mittelblatt
Valve centrale
Valva central
45 x 80 mm

BV-156
Valva centrale
Center blade
Mittelblatt
Valve centrale
Valva central
60 x 80 mm

BV-157
Valva centrale
Center blade
Mittelblatt
Valve centrale
Valva central
80 x 80 mm

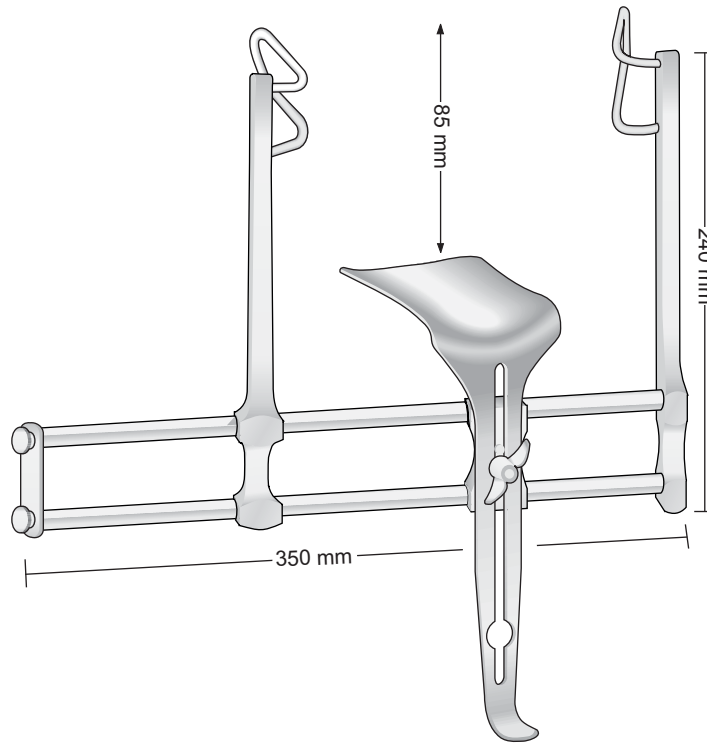

BALFOUR MODIF.
BV-46

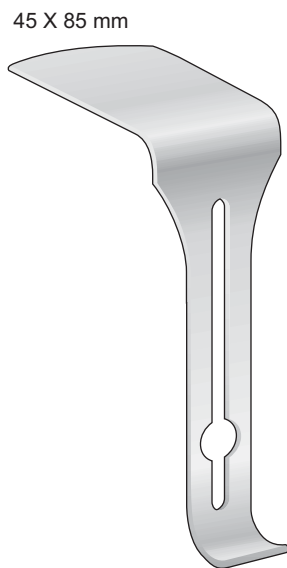

BV-150
170 mm

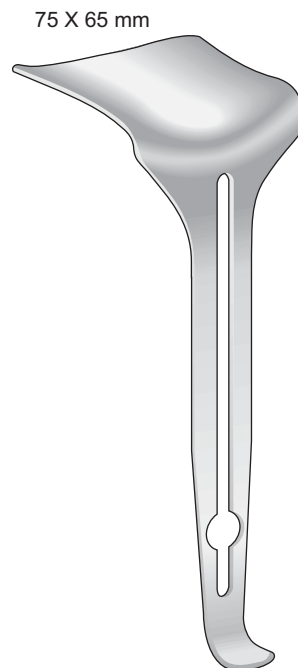

BV-151
230 mm



BV-152
200 mm

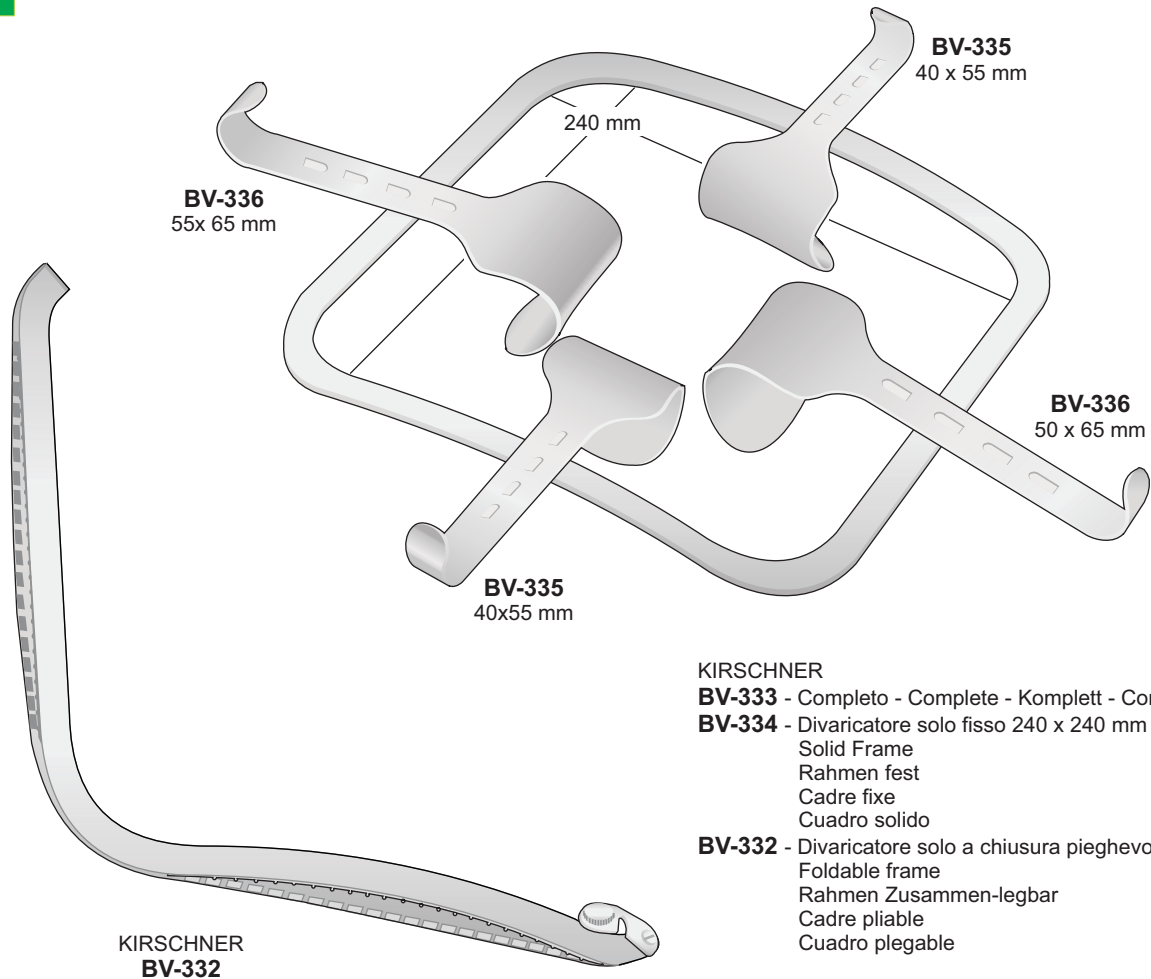

KIRSCHNER
BV-333 - Completo - Complete - Komplet - Complet - Completo
BV-334 - Divaricatore solo fisso 240 x 240 mm
 Solid Frame
 Rahmen fest
 Cadre fixe
 Cuadro solido
BV-332 - Divaricatore solo a chiusura pieghevole 240 x 240 mm
 Foldable frame
 Rahmen Zusammen-legbar
 Cadre pliable
 Cuadro plegable

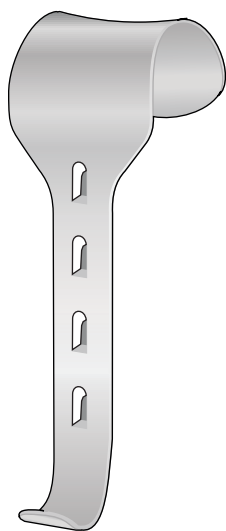

KIRSCHNER
BV-335
 40 x 55 mm

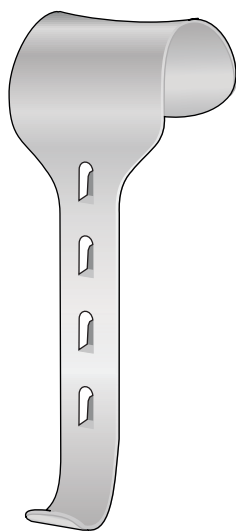

KIRSCHNER
BV-331 - 65 x 80 mm
BV-336 - 50 x 65 mm

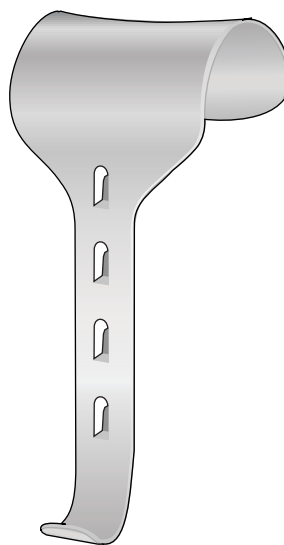

KIRSCHNER
BV-337 - 60 x 85 mm
BV-338 - 78 x 65 mm
BV-339 - 90 x 65 mm

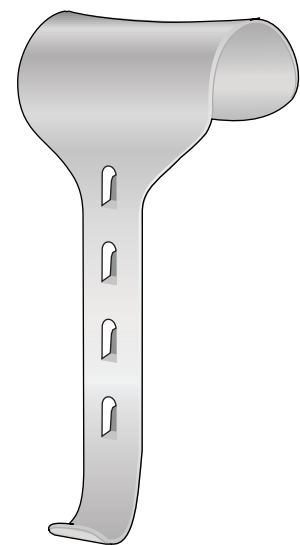

KIRSCHNER
BV-346 - 80 x 80 mm
BV-347 - 80 x 90 mm
BV-348 - 90 x 90 mm

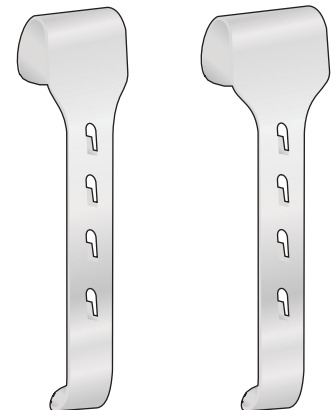
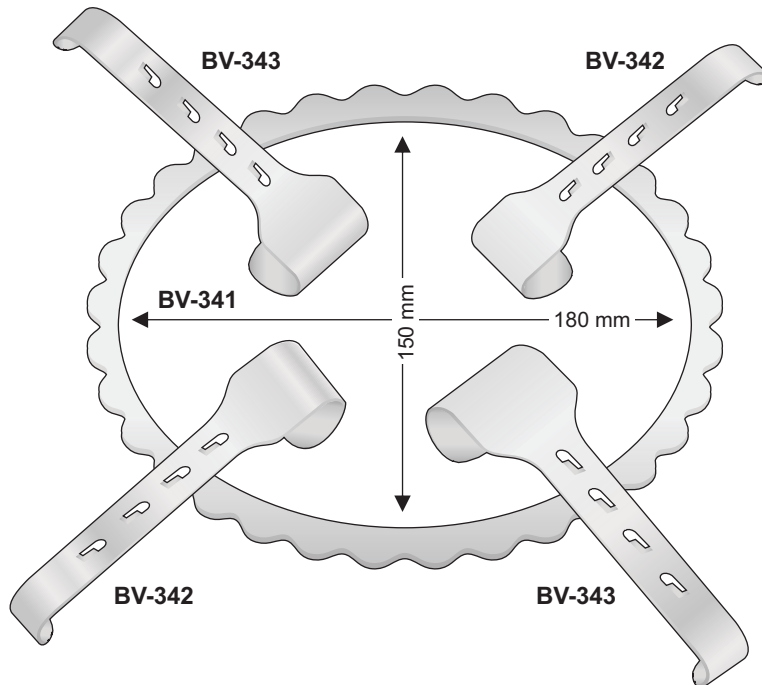

BV-344
20 x 30 mm

BV-345
20 x 40 mm

**DENIS-BROWNE
BV-340**

Set completo per bambini
Set complete for children
Komplettset für Kinder
Set complete pour enfants
Set completo para niños

- BV-341** - 1 Cornice 180 x 150 mm
- BV-344** - 2 Valve 20 x 30 mm
- BV-345** - 2 Valve 20 x 40 mm

BV-341
180 x 150 mm
Cornice sola
Frame only
Rahmen allein
Ecarteur seul
Separador suelto

Per bambini - For children
Für Kinder - Pour enfants
Para niños

**DENIS-BROWNE
BV-350**

Set completo per adulti
Set complete for adults
Komplettset für Erwachsene
Set complete pour adultes
Set completo para adultos

- BV-349** - 1 Cornice 255 x 180 mm
- BV-342** - 2 Valve 40 x 30 mm
- BV-343** - 2 Valve 40 x 40 mm

BV-349
255 x 180 mm
Cornice sola
Frame only
Rahmen allein
Ecarteur seul
Separador suelto

Per adulti - For adults
Für erwachsene - Pour adultes
Para adultos

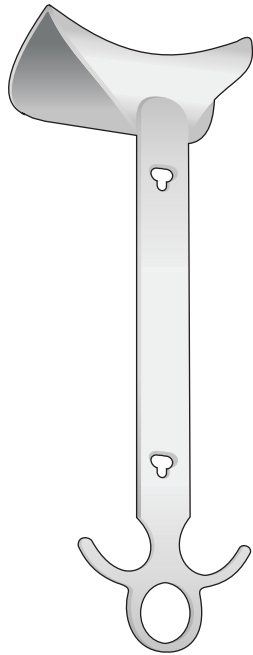

ROCHARD
BV-383 - 60 x 95 mm
BV-384 - 60 x 105 mm
BV-385 - 60 x 120 mm
BV-386 - 60 x 135 mm
BV-387 - 60 x 155 mm
 270 mm

Dispositivo di fissaggio
 Fixation device
 Fixiervorrichtung
 Dispositif de fixation articulé
 Dispositivo de fijación

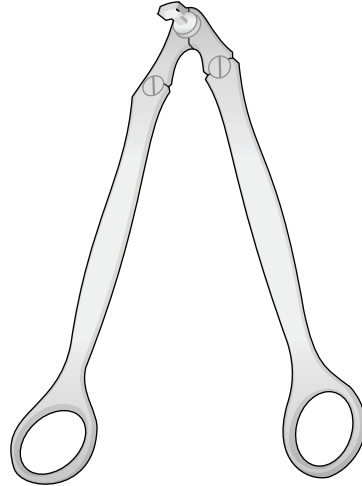

ROCHARD
BV-388
 190 mm

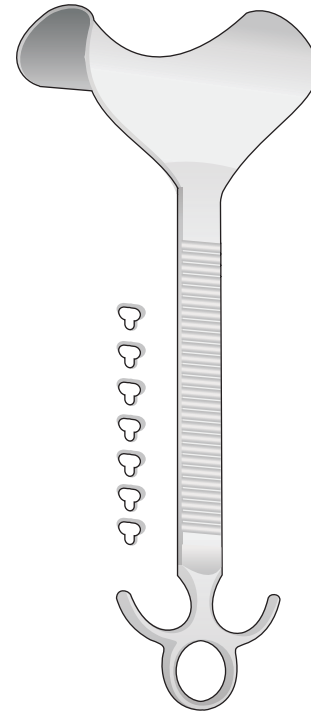

DOYEN
BT-255 - 50 x 85 mm
BT-256 - 48 x 90 mm
BT-257 - 48 x 105 mm
BT-258 - 48 x 120 mm
BT-259 - 48 x 135 mm
 280 mm

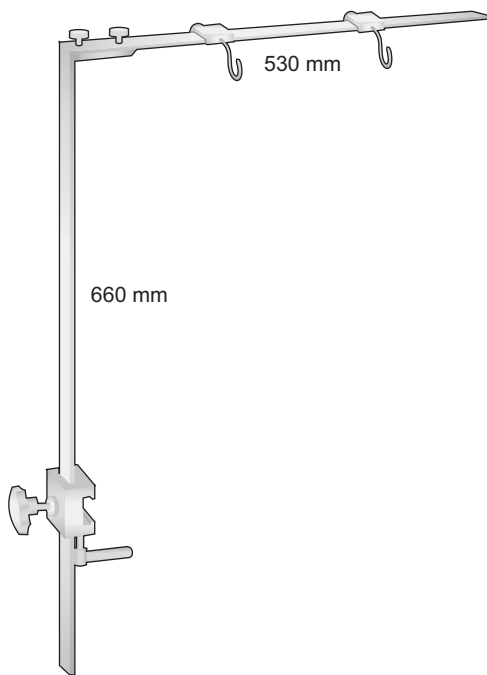

ROCHARD
BV-389

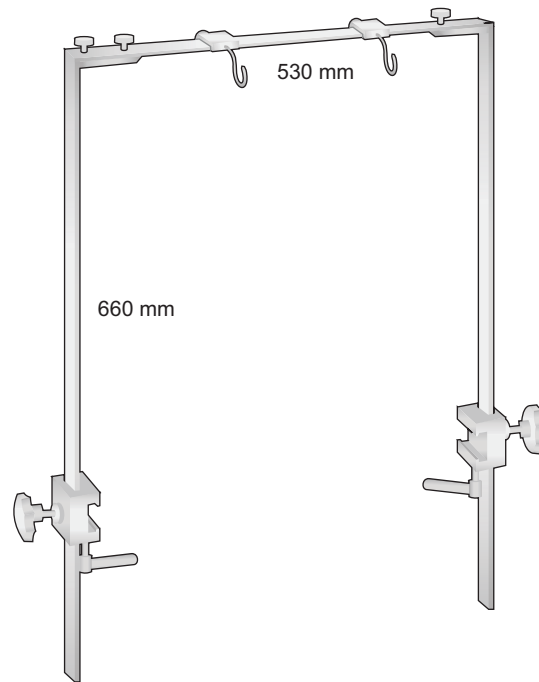

ROCHARD
BV-390

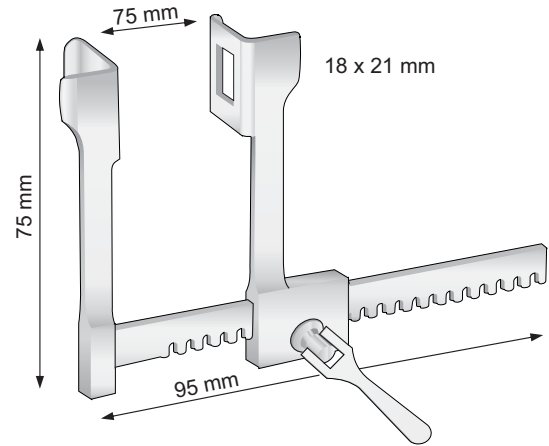
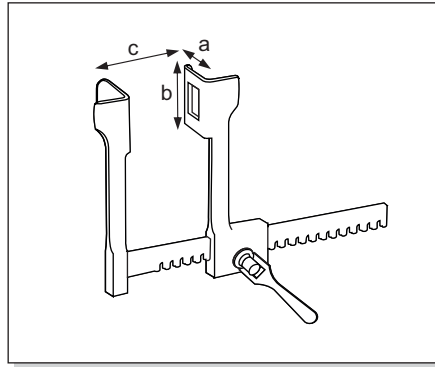

BABY FINOCCHIETTO
a b c
BV-60 18 x 20 mm 75 mm

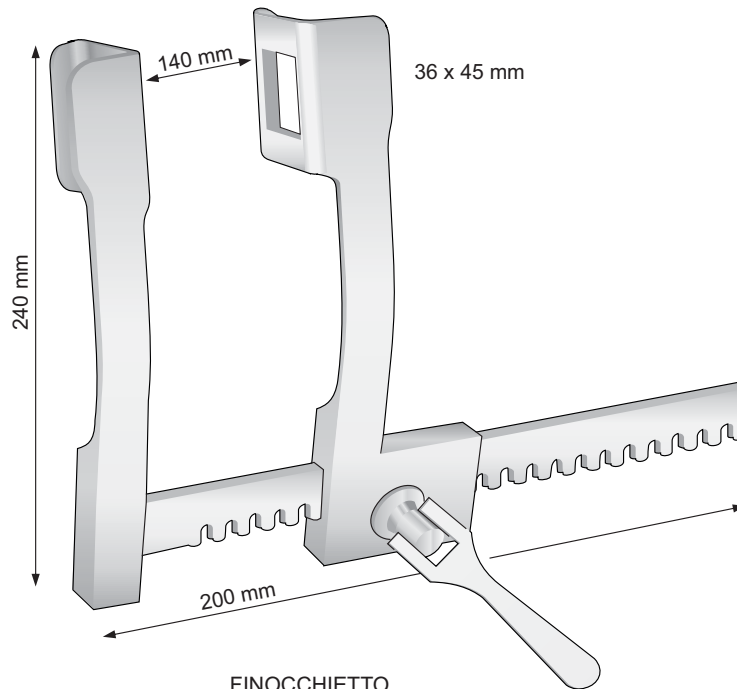

FINOCCHIETTO
a b c
BV-62 40 x 40 mm 165 mm
BV-64 45 x 65 mm 200 mm
BV-66 70 x 65 mm 250 mm

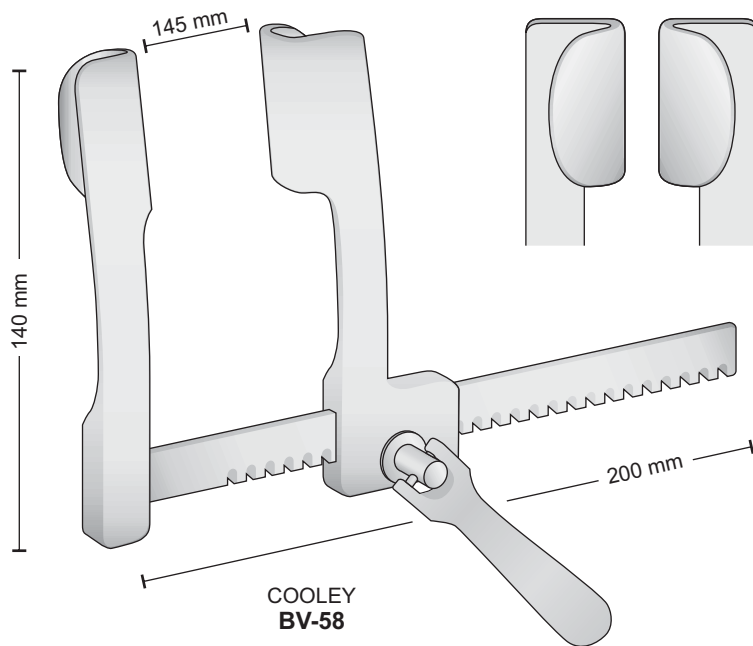

Valve
Blades
Blätter
Valves
Valvas
21 x 45 mm

Per bambini
For children
Für kinder
Pour enfants
Para niños

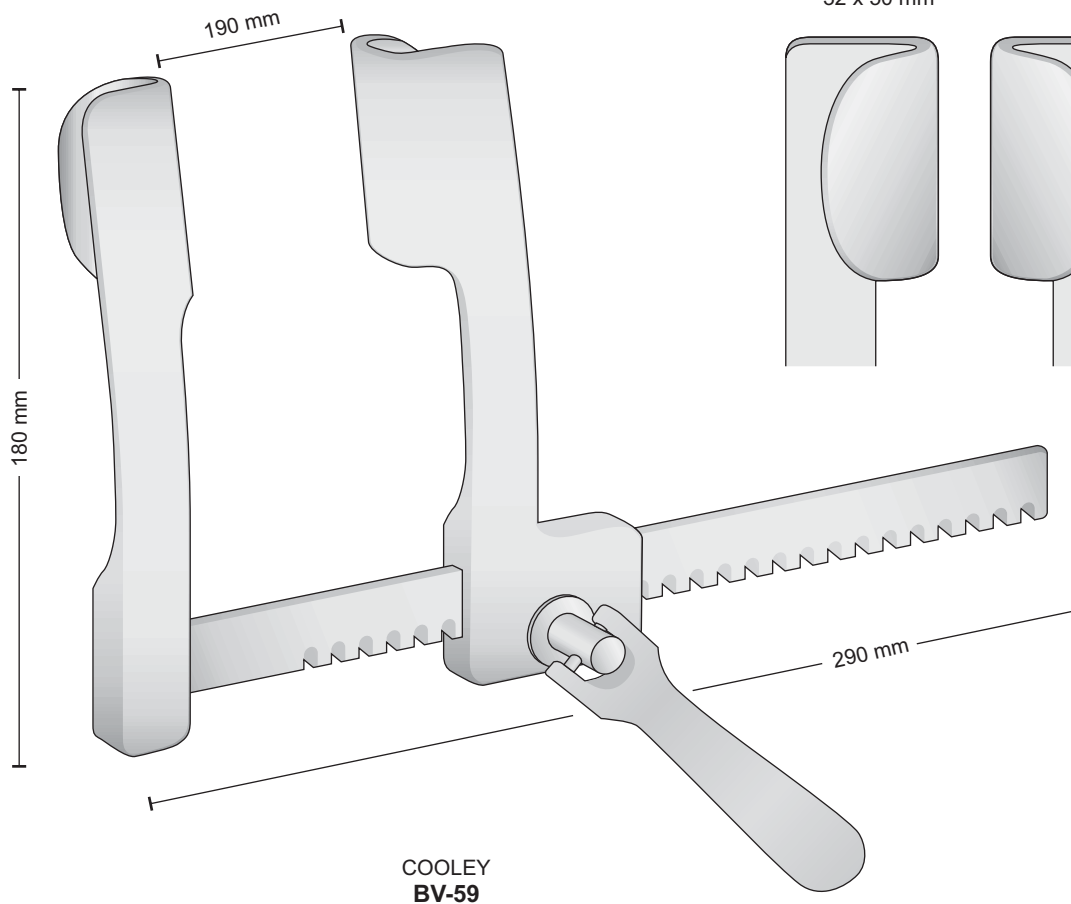

Valve
Blades
Blätter
Valves
Valvas
32 x 50 mm

Per adulti
For adults
Für Erwachsene
Pour adultes
Para adultos

Valve - Blade - Blätter
Valve - Valvas
50 x 43 mm

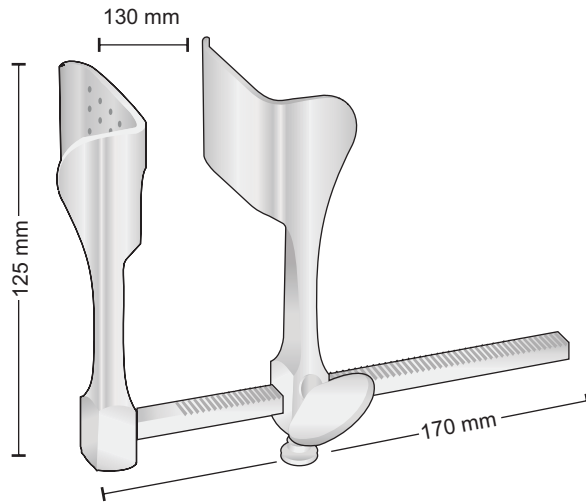

TUFFIER
BV-57

Divaricatori per sternotomia
Sternotomy spreaders
Sternotomie-Sperrer
Ecarteurs à sternotomie
Separador para sternotomia

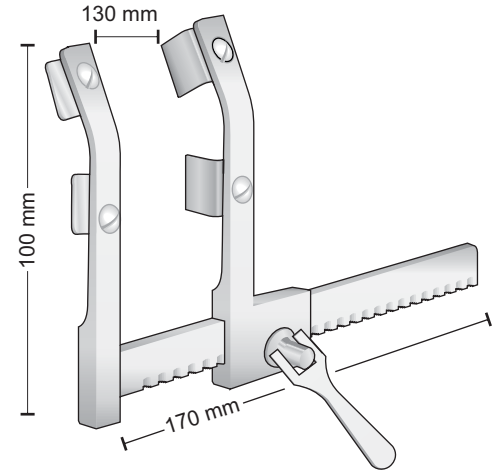

BABY-MORSE
BV-125

Divaricatori per sternotomia - Sternotomy spreaders - Sternotomie-Sperrer
Ecarteurs à sternotomie - Separador para sternotomia

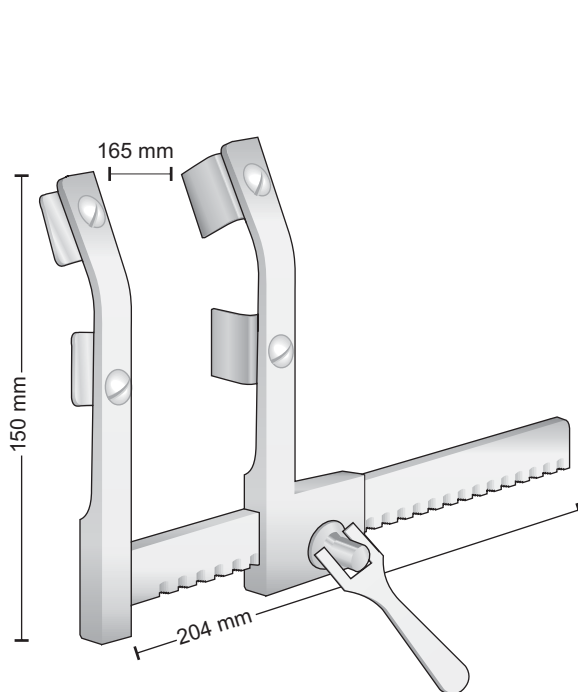

MORSE
BV-126

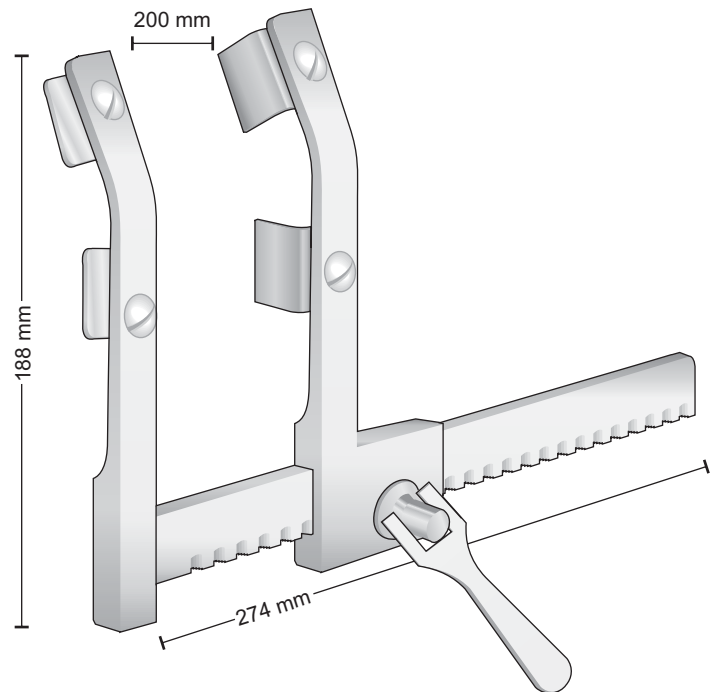

MORSE
BV-128

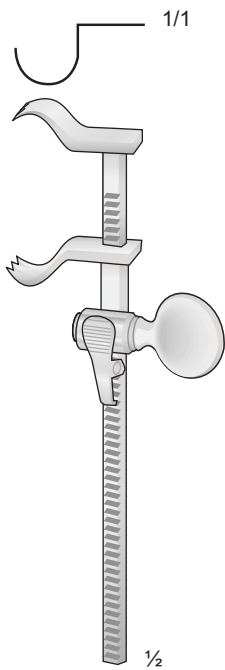

BAILEY
FB-296
160 mm

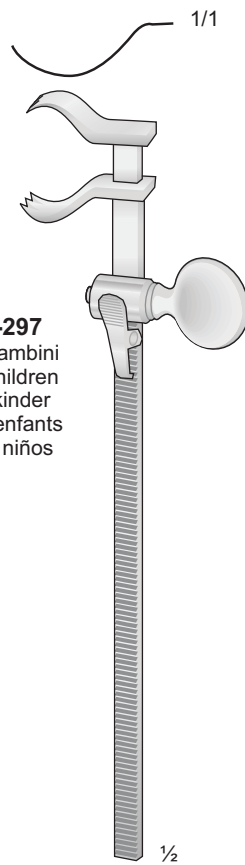

FB-297
Per bambini
For children
Für kinder
Pour enfants
Para niños

BAILEY
FB-297-FB-298
200 mm

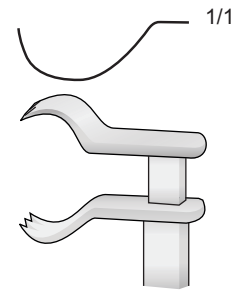

FB-298
Per adulti
For adults
Für Erwachsene
Pour adultes
Para adultos

Valva centrale
Center blade
Mittelblatt
Valve centrale
Valva central

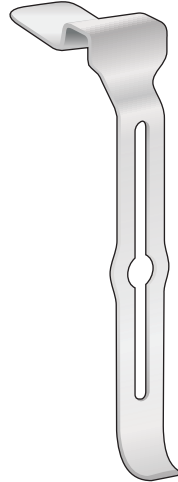

BV-355

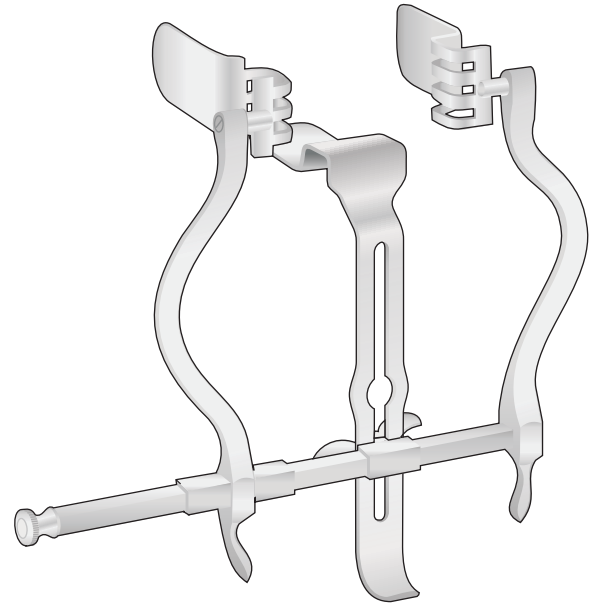

**JUDD-MASSON
BV-354**

Speculum rettale
Rectal specula
Mastdarm rektum spekulum
Spéculum pour rectum
Espéculus rectales

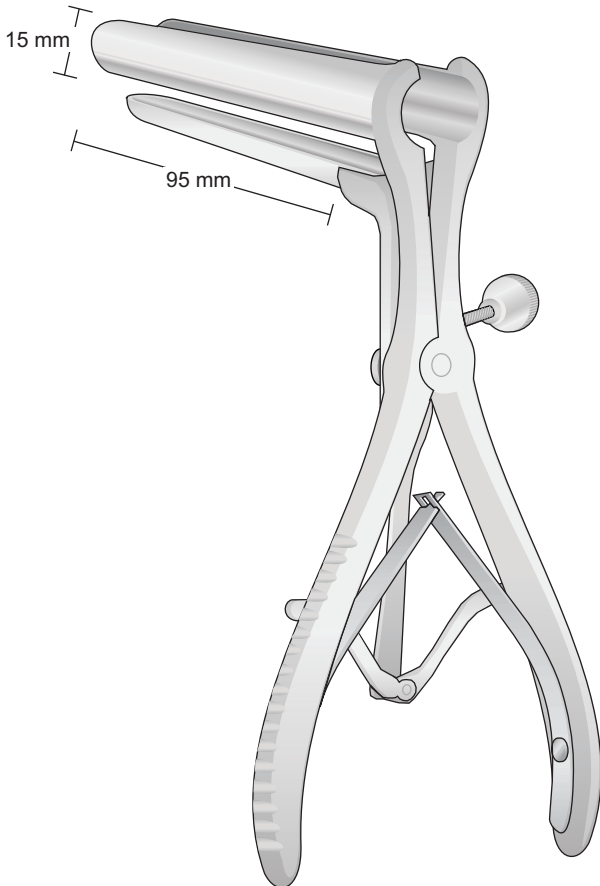

**MATHIEU
EA-40
215 mm**

BV-358

Divaricatore solo - Retractor only
Sperrer allein - Ecarteur seul
Separador suelto

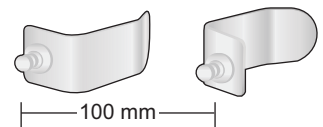

BV-360

Valva laterale
Lateral blade
Seitliche Blätter
Valves latérales
Valva laterales
80 x 25 mm

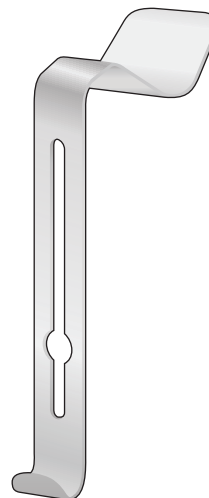

BV-359

Valva centrale - Center blade - Mittelblatt
Valve centrale - Valva central

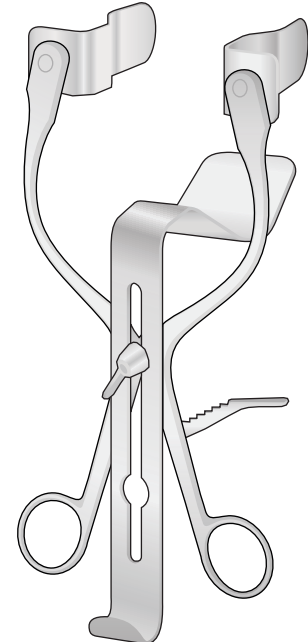

**MILLIN
BV-357**

Completo - Complete - Komplett
Complet - Completo

09

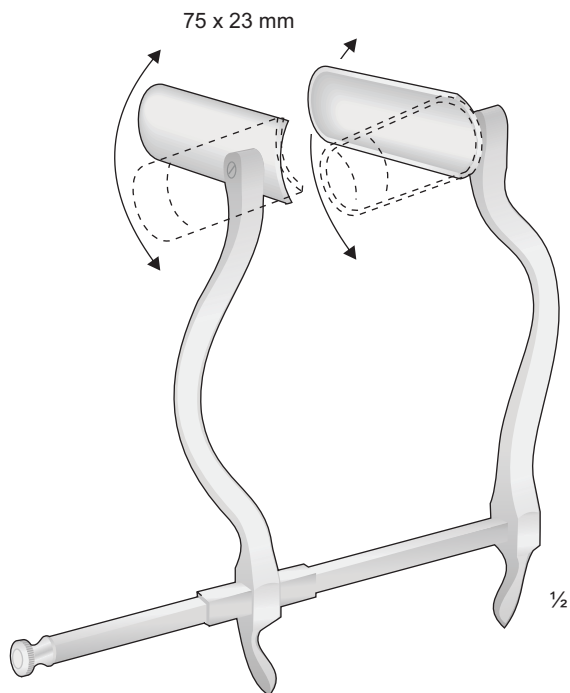

SMITH-BUIE
BV-241
150 mm



BARR
BV-242
170 mm

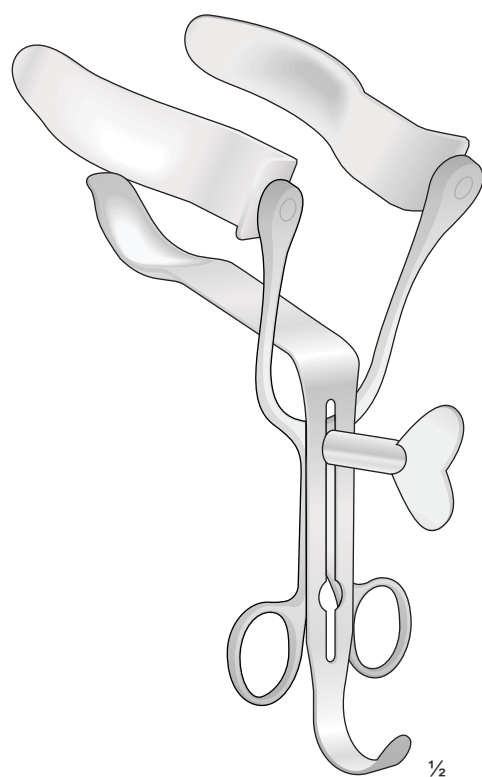

ALAN PARKS
BV-245

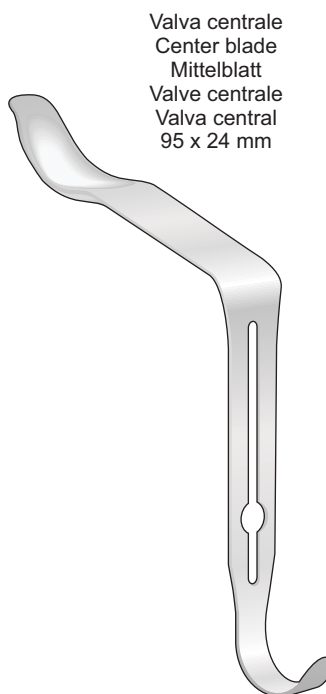

BV-248

Valva centrale
Center blade
Mittelblatt
Valve centrale
Valva central
95 x 24 mm

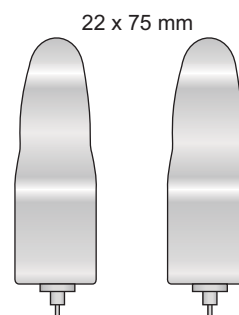

BV-246

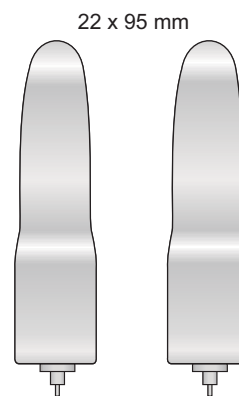

BV-247

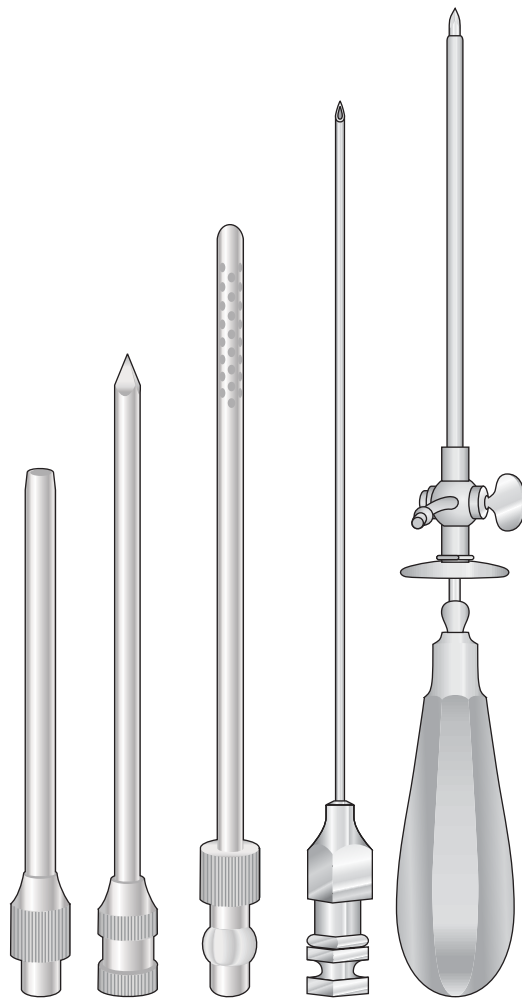

10 |

Trocar | Biopsy Needles
Trokar | Biopsienadeln
Trocart | Aiguilles pour biopsie
Trocar | Agujas para biopsia
Trocar | Aghi da biopsia

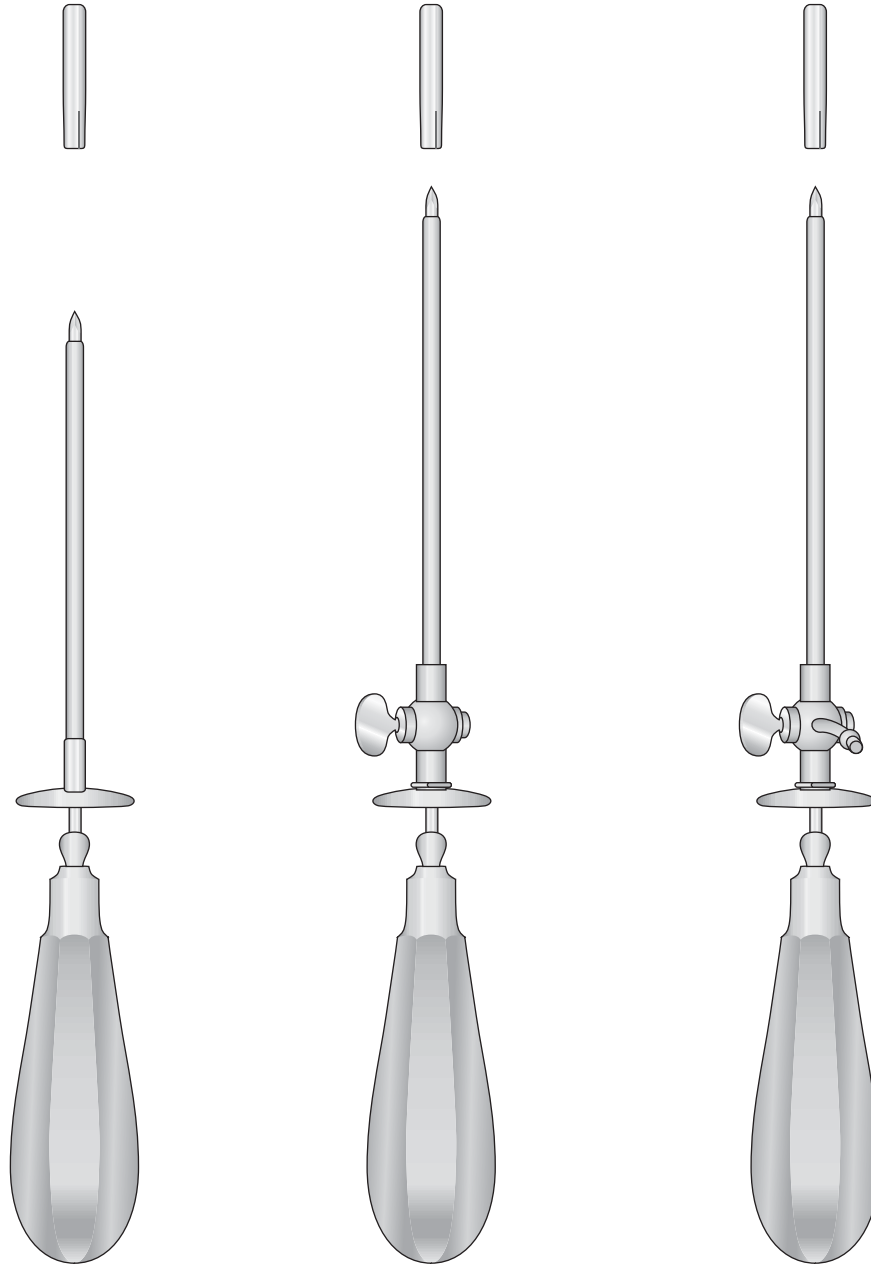

Ø mm	Ø mm
Esterno	Interno
Outside	Inside
Außen	Innen
Extérieur	Intérieur
Exterior	Interior

		STANDARD	STANDARD	STANDARD
3,0	2,0	TR-40	TR-20	TR-51
3,5	2,5	TR-44	TR-21	TR-52
4,0	3,0	TR-41	TR-22	TR-53
4,5	3,5	TR-45	TR-23	TR-54
5,0	4,0	TR-42	TR-24	TR-55
5,5	4,5	TR-46	TR-25	TR-56
6,0	5,0	TR-43	TR-26	TR-57

110 mm

120 mm

120 mm

Per vescica biliare - For gall bladder - Für die gallenblase
 Pour la vésicule biliaire - Para vesícula biliar

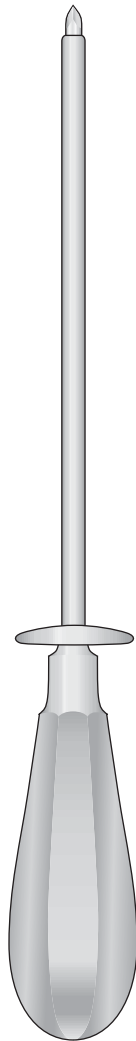
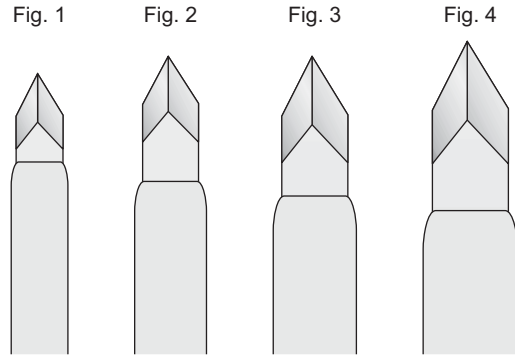

Ø mm Esterno Outside Außen Extérieur Exterior	Ø mm Interno Inside Innen Intérieur Interior		
7,5	6,0	Fig. 1	TR-61
9,5	8,0	Fig. 2	TR-62
11,0	9,5	Fig. 3	TR-63
12,5	11,0	Fig. 4	TR-64
210 mm			

NELSON

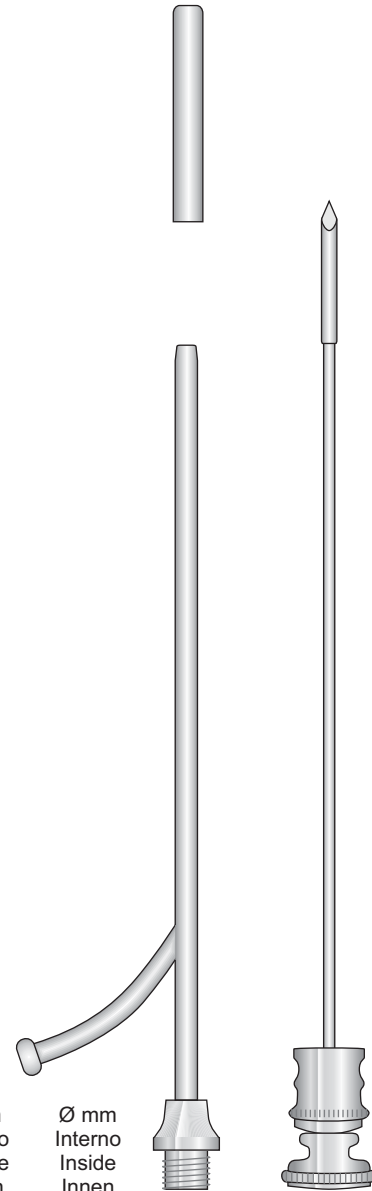

Ø mm Esterno Outside Außen Extérieur Exterior	Ø mm Interno Inside Innen Intérieur Interior		
4,0	3,0		GF-120
4,6	3,6		GF-121
5,3	4,3		GF-122
6,0	5,0		GF-123
210 mm			

OCHSNER

Trequarti per seno mascellare
 Antrum puncture trocars
 Kieferhöhlentrokare
 Trocarts pour sinus maxillaire
 Trócares para punción del seno maxilar

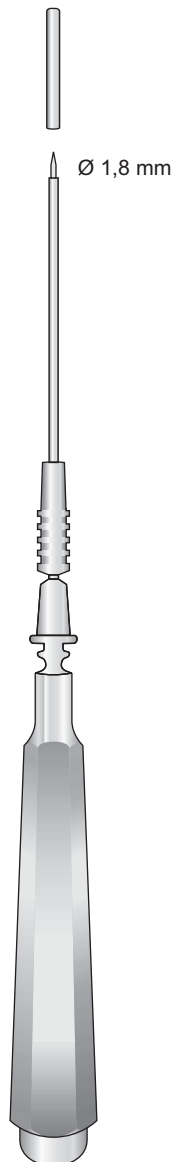

LICHTWITZ
TR-30
 190 mm

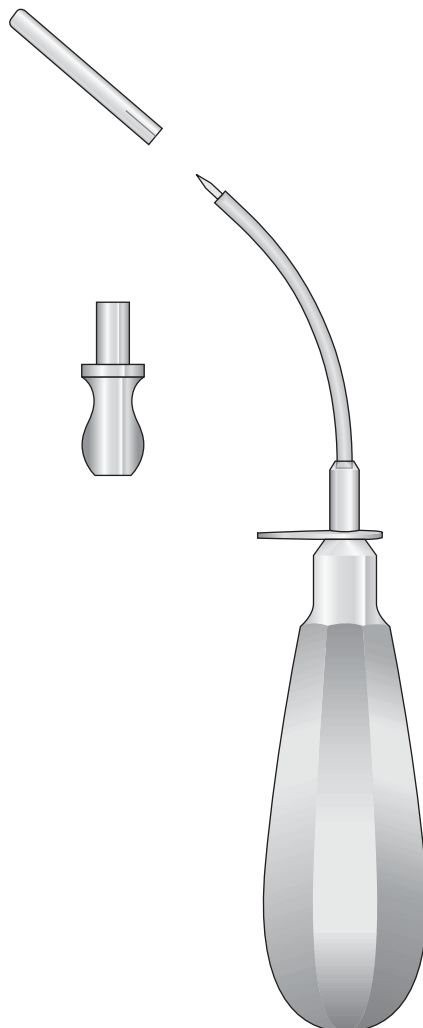

PIERCE
TR-32 Ø 3 mm
TR-33 Ø 4 mm
TR-34 Ø 5 mm
 160 mm

Set completo Krause
 Krause set complete
 Krause Kompletset
 Set complet Krause
 Set completo Krause

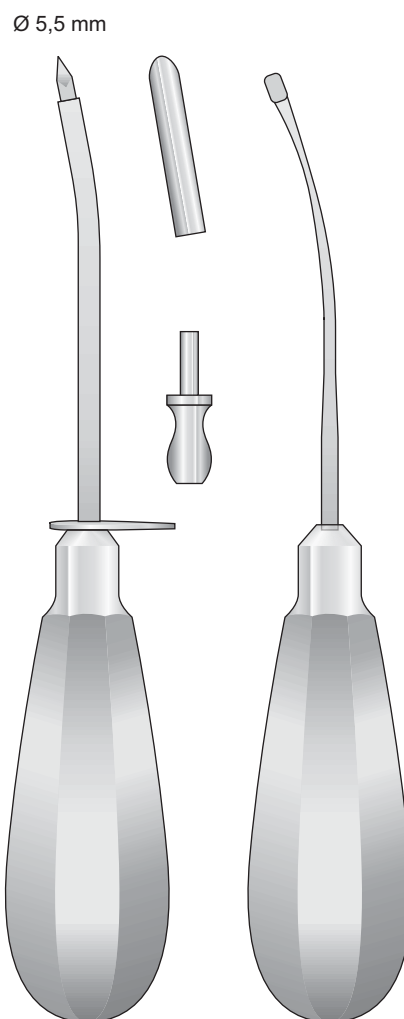

KRAUSE
TR-35
 160 mm

Universale completo con 3 punte
Set of 3 pieces
Satz zu 3 stück
Jeu de 3 pièces
Juego de 3 piezas

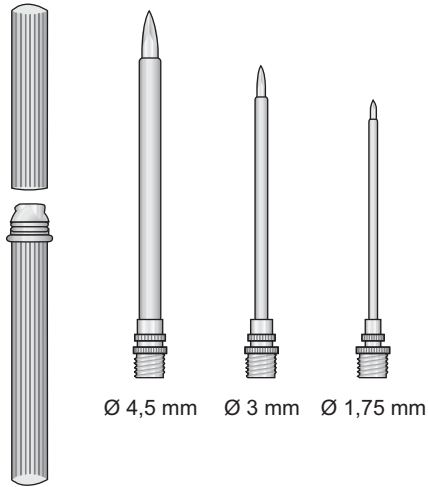

UNIVERSAL
TR-47

Universale completo con 4 punte
Set of 4 pieces
Satz zu 4 stück
Jeu de 4 pièces
Juego de 4 piezas

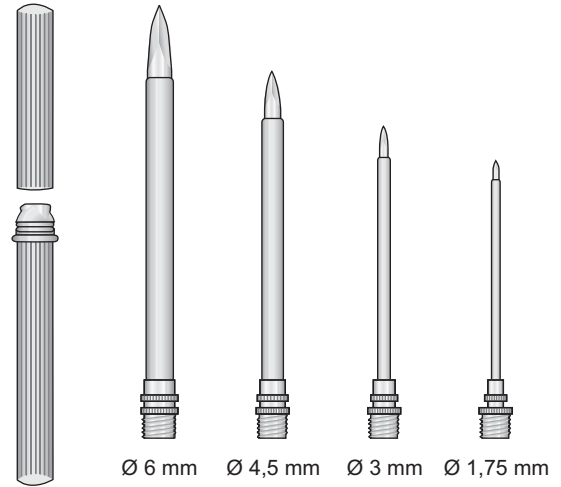

UNIVERSAL
TR-48

Universale completo con 3 punte
Set of 3 pieces
Satz zu 3 stück
Jeu de 3 pièces
Juego de 3 piezas

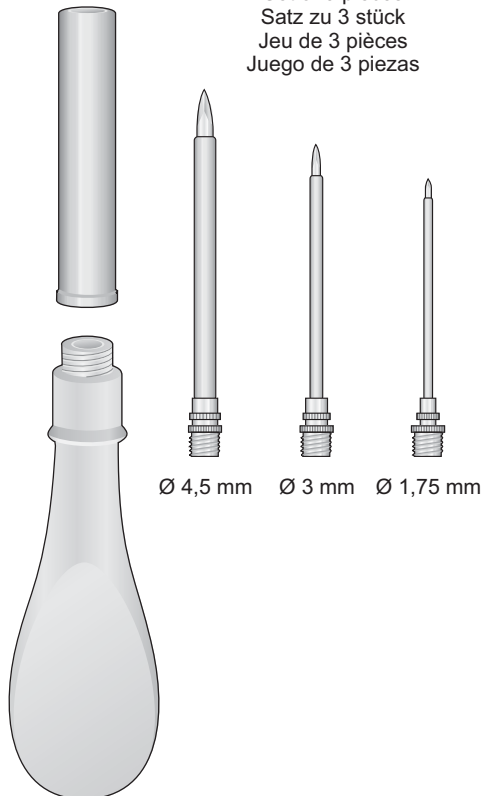

TR-49
130 mm

Universale completo con 4 punte
Set of 4 pieces
Satz zu 4 stück
Jeu de 4 pièces
Juego de 4 piezas

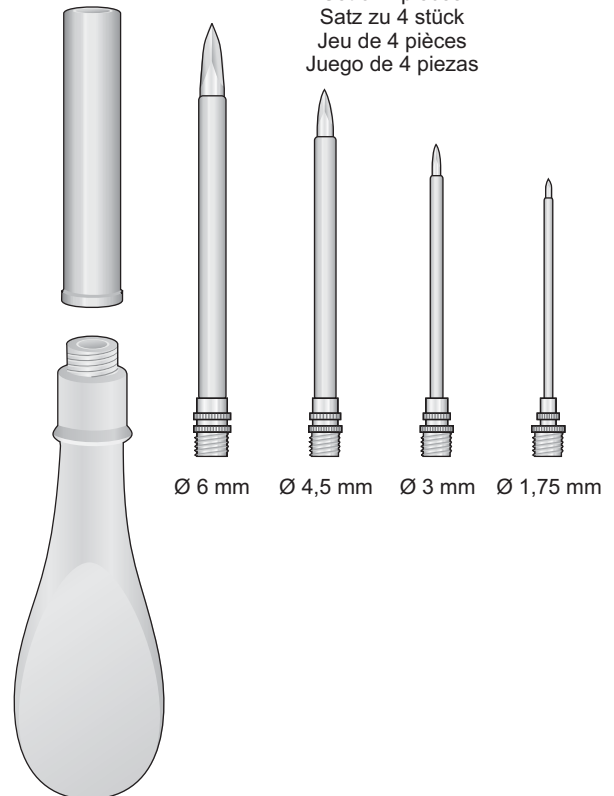

TR-50
130 mm

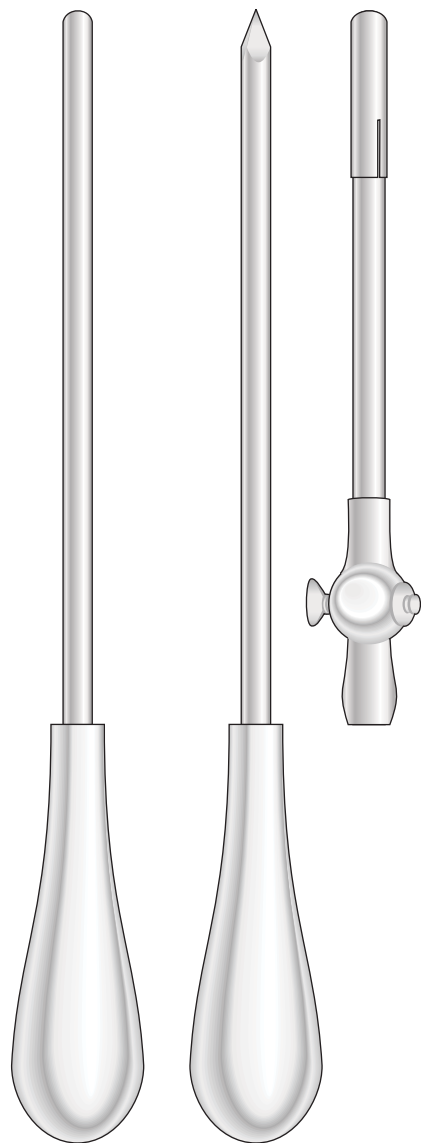

Ago per la puntura dello sterno
 Sternal puncture needle
 Sternal-punktionskänülen
 Aiguilles pour la ponction sternale
 Agujas para punción esternal

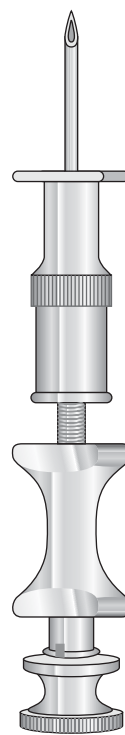

Ø mm	Ø mm
Esterno	Interno
Outside	Inside
Außen	Innen
Extérieur	Intérieur
Exterior	Interior

BUELAU

8

6,5

TR-68

10

8,5

TR-69

240 mm

KLIMA-ROSEGGER
OL-40

1,80 x 35 mm

DUKE
GF-106

110 mm - 5,5 mm



OL-01
120 mm

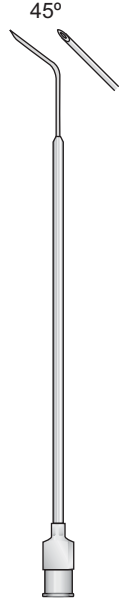

OL-02
110 mm

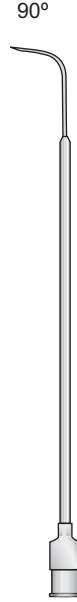

OL-03
110 mm



OL-04
110 mm

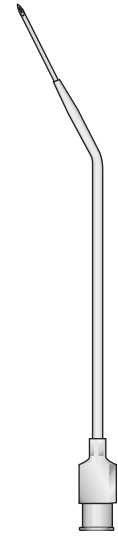

OL-05
110 mm

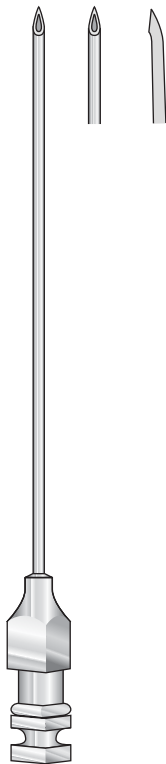

TUOHY
OL-41 - 1,30 x 80 mm
OL-42 - 1,50 x 80 mm
OL-43 - 1,65 x 80 mm



QUINCKE
OL-44 - 0,70 x 80 mm
OL-45 - 0,70 x 90 mm
OL-46 - 1,00 x 80 mm
OL-47 - 1,00 x 90 mm
OL-48 - 1,20 x 90 mm
OL-49 - 1,20 x 100 mm

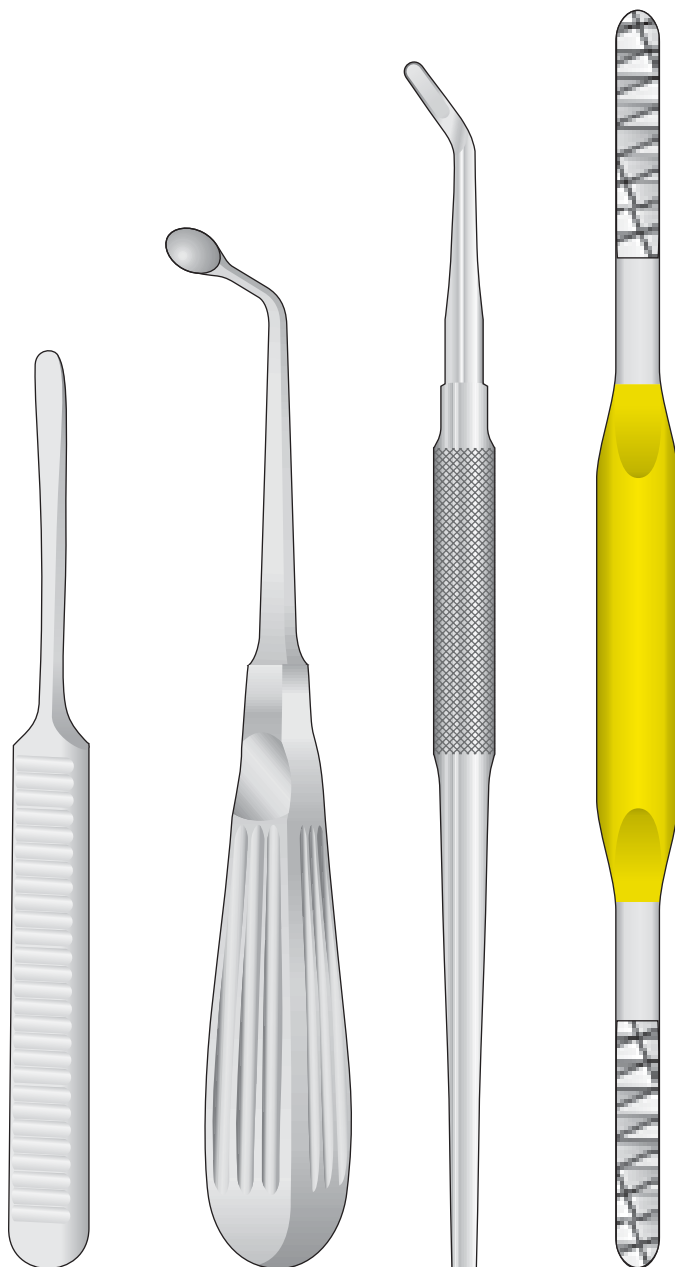

11

Elevators | Periosteal | Bone files | Curettes
Elevatoren | Raspatorien | Knochenfeilen | Küretten
Élévateurs | Rugines périostiques | Limes à os | Curettes
Elevadores | Periostótomos | Limas para hueso | Curetas
Elevatori | Scollaperiosteo | Lime per osso | Curettes

6 mm



8 mm
DO-242
135 mm

8 mm



10 mm
DO-243
135 mm

4,5 mm

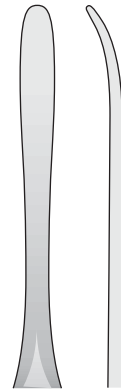

**KÖNIG
KO-1**
155 mm

4,5 mm

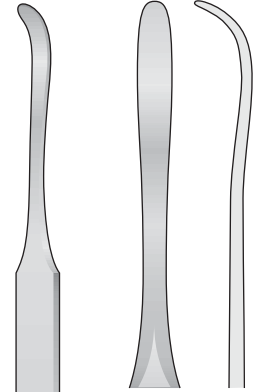

**KÖNIG
KO-2**
155 mm

5 mm

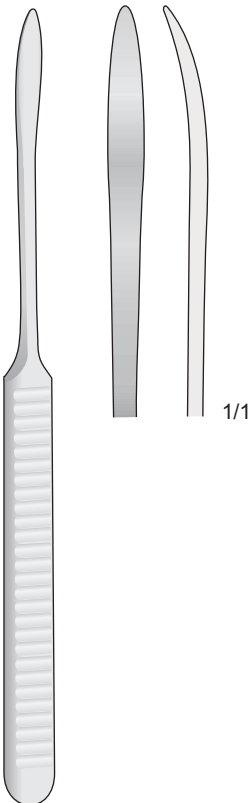

**WILLIGER
WG-10**
165 mm

6 mm

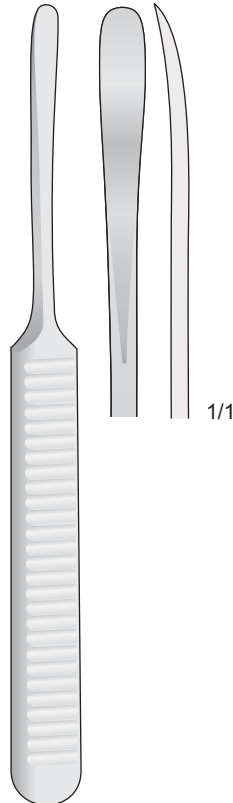

**WILLIGER
WG-12**
160 mm

4 mm

Periostotomi
Periosteal Raspatories
Raspatorien
Rugines à périostomie
Legras periostotomos

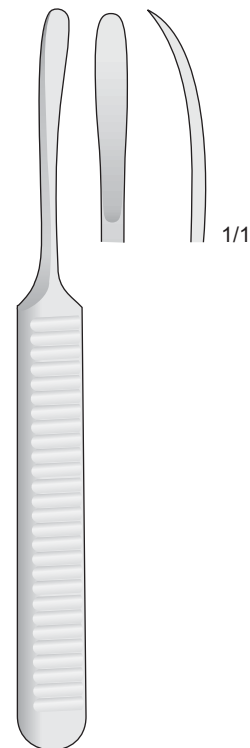

**WILLIGER
WG-14**
140 mm

11

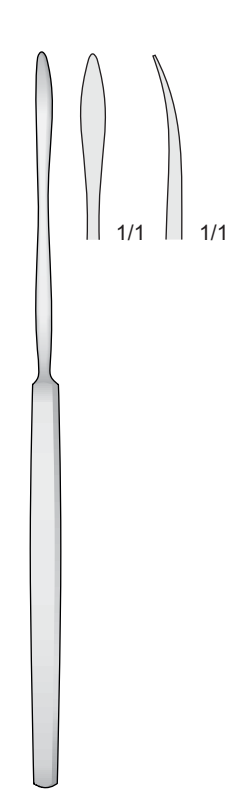

KO-18
175 mm

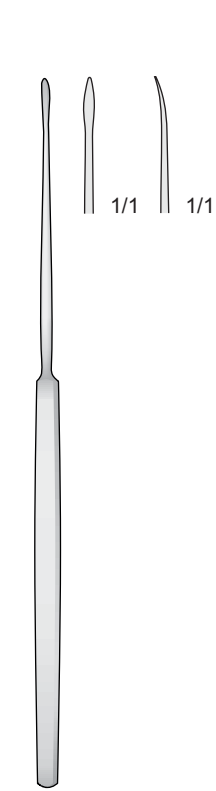

KO-19
160 mm

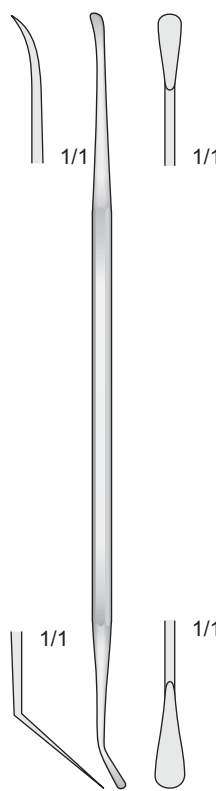

**MILLIGAN
KO-27**
210 mm

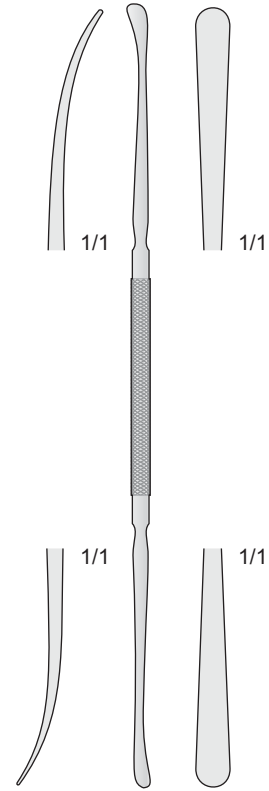

**DAVIS
KO-21**
245 mm

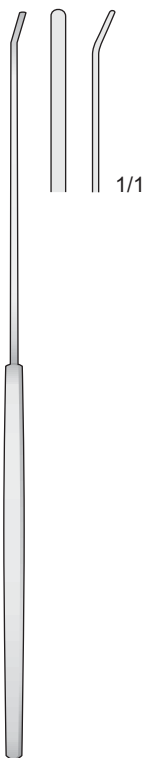

**FAGER
KO-24**
200 mm

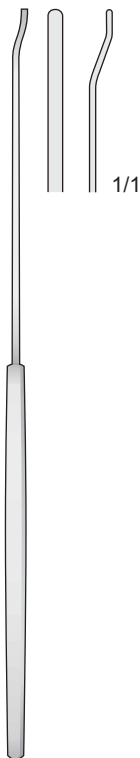

**FAGER
KO-25**
200 mm



**SACHS
KO-26**
210 mm

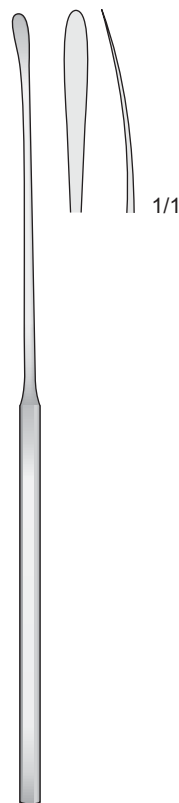

**SACHS
KO-28**
210 mm

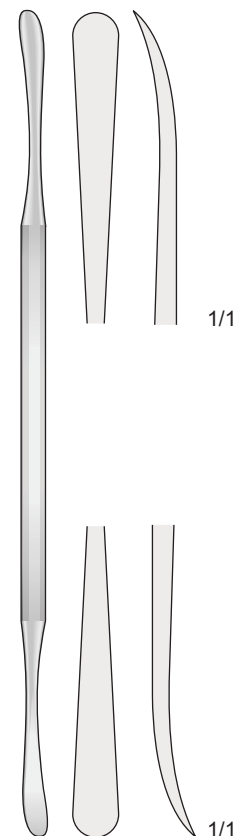

KO-29
220 mm

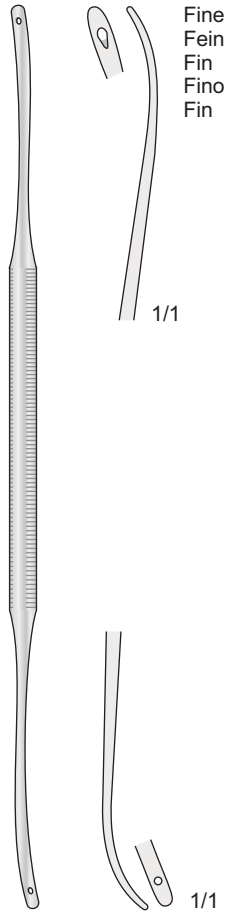

KO-14 - 180 mm
KO-15 - 240 mm

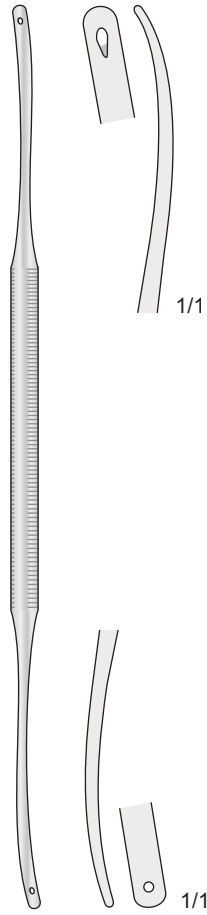

KO-16 - 180 mm
KO-17 - 240 mm

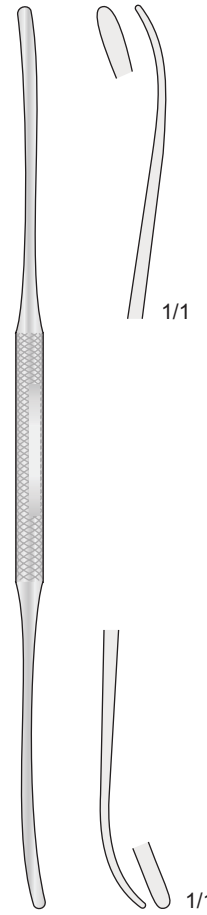

OLIVECRONA
KO-47 - 180mm
KO-48 - 240mm

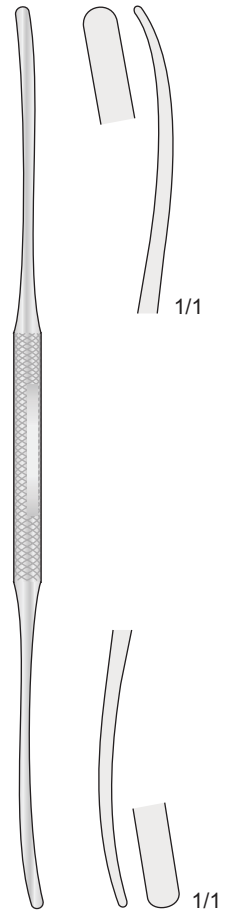

OLIVECRONA
KO-49 - 195mm
KO-50 - 240mm

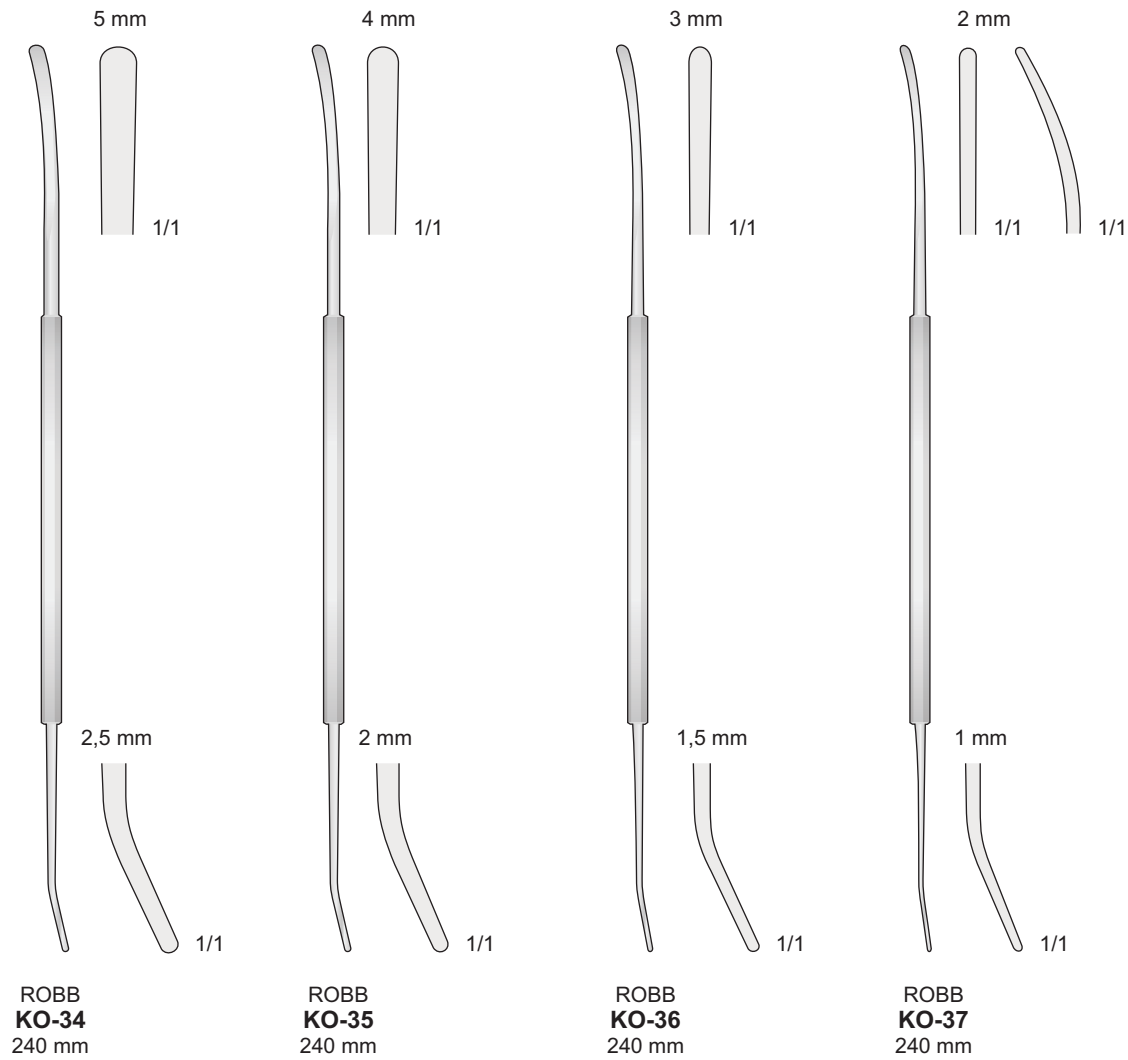

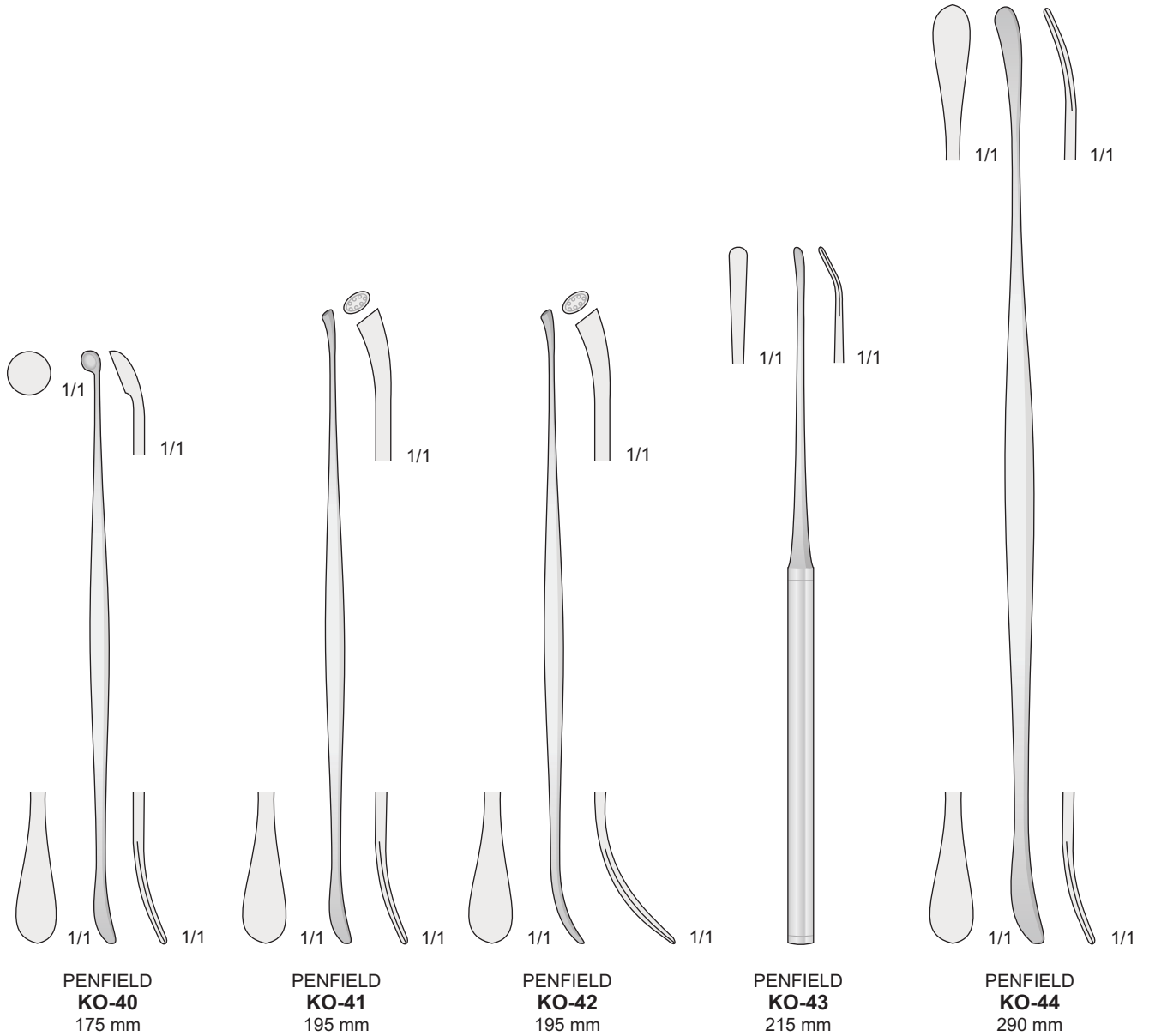

Nerve protectors

Destro	Sinistro
Right	Left
Rechts	Links
À droite	À gauche
A la derecha	A la izquierda

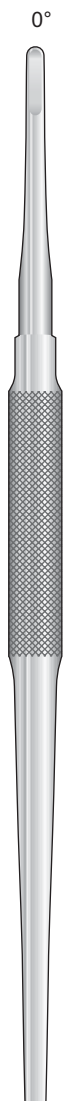

DO-220
165 mm

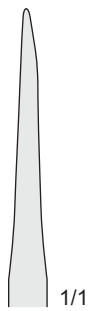

DO-221
165 mm

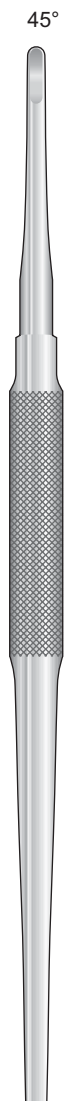
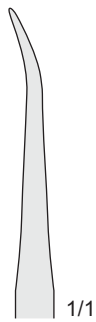

DO-222
165 mm

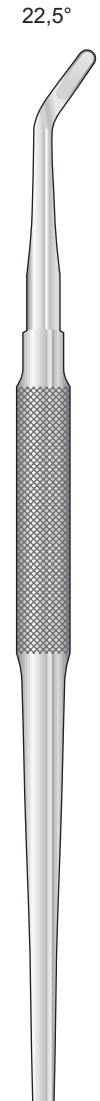
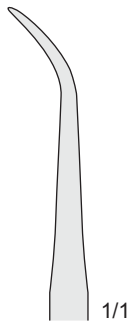

DO-223
165 mm

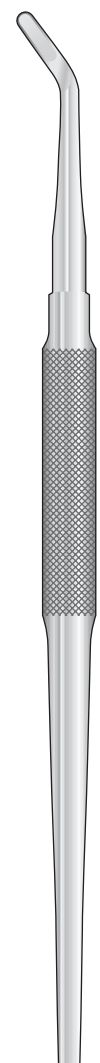

DO-224
165 mm

Elevatori orbitali

Sinistro
Left
Links
À gauche
A la izquierda

Destro
Right
Rechts
À droite
A la derecha

5 mm

5 mm

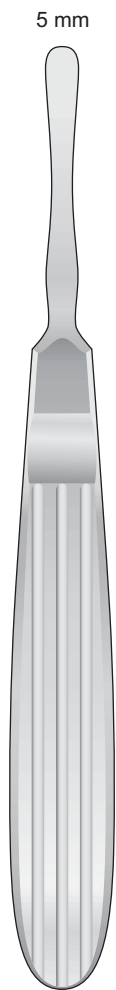

DO-98
145 mm

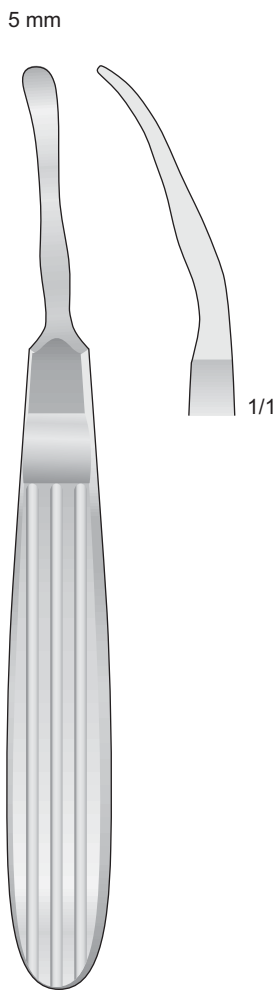

DO-99
140 mm



DO-104
160 mm

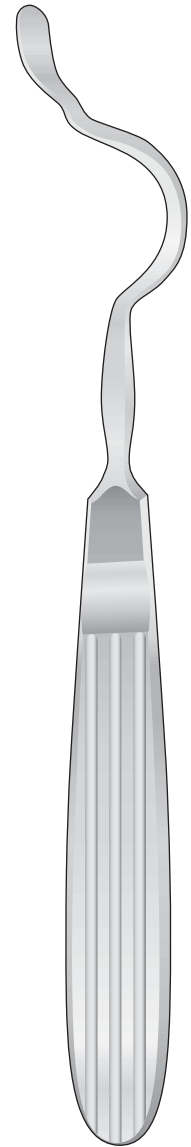

DO-105
160 mm

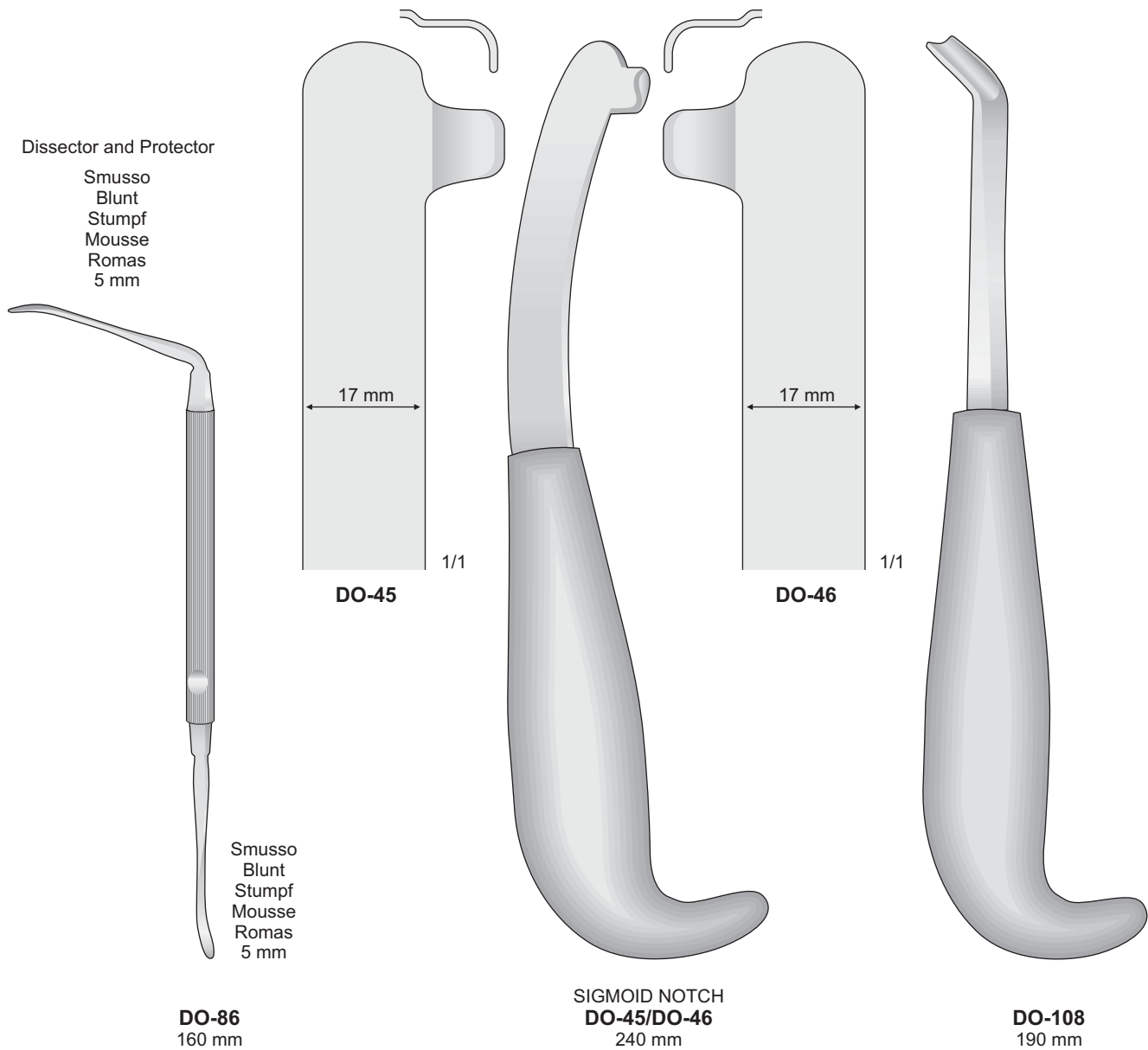

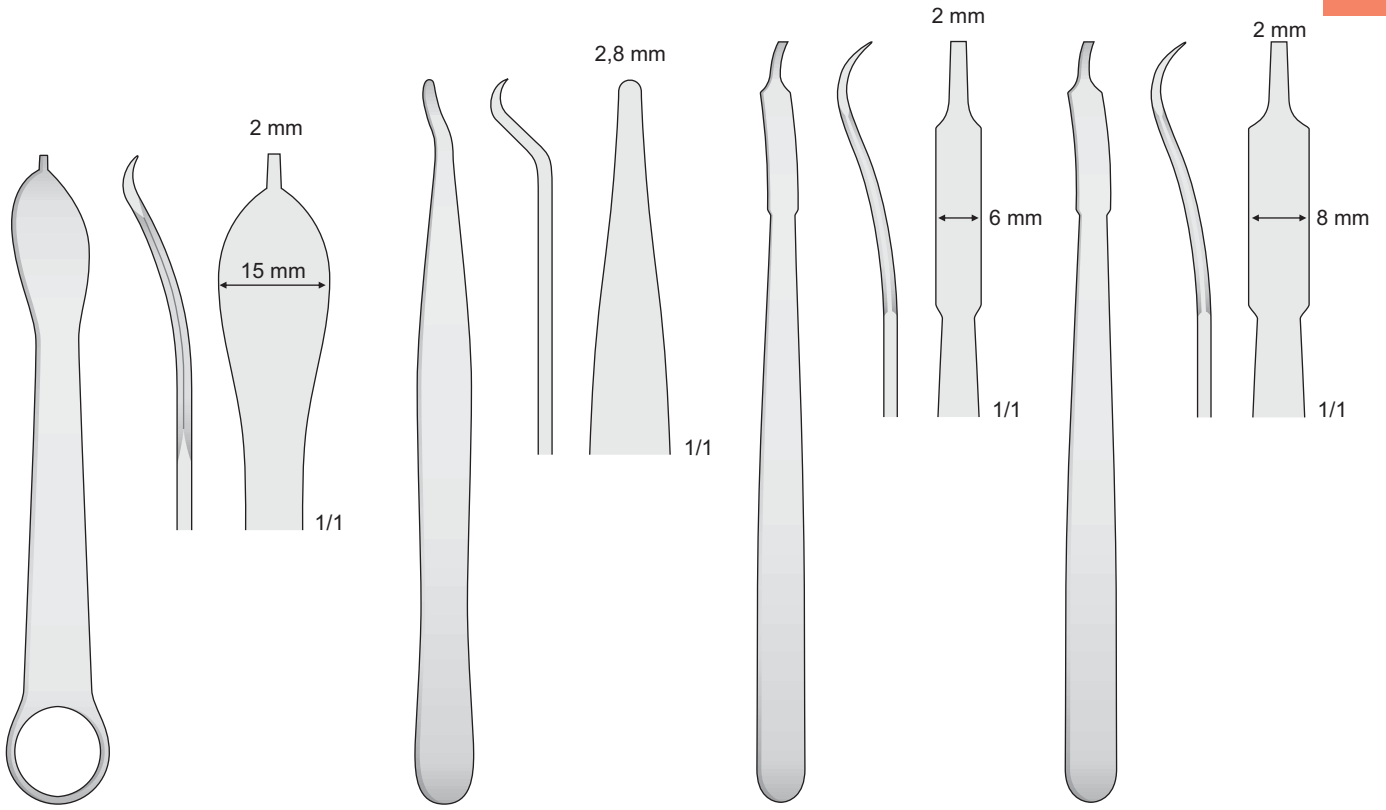

FK-45
120 mm

FK-46
140 mm

MINI-HOHMANN
FK-48
160 mm

MINI-HOHMANN
FK-49
160 mm

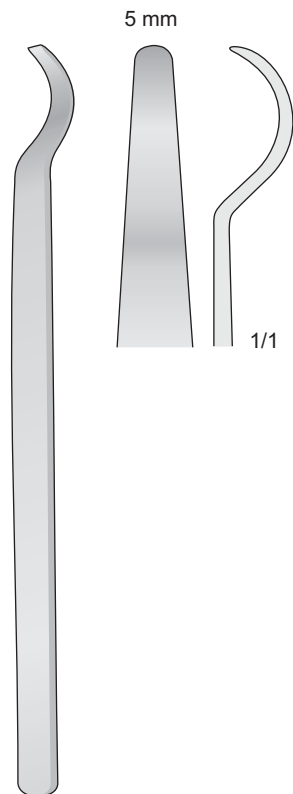

FK-30
150 mm

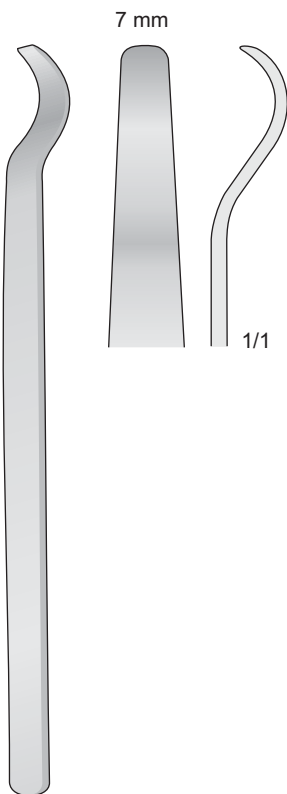

FK-28
150 mm

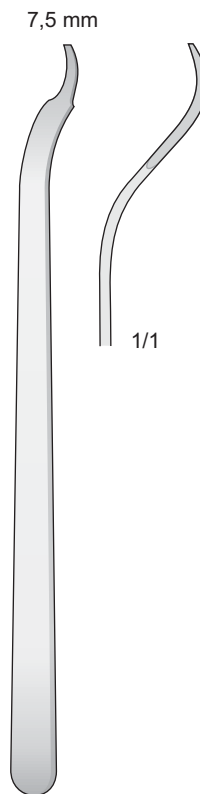

BUCK-GRAMCKO
FK-20
150 mm

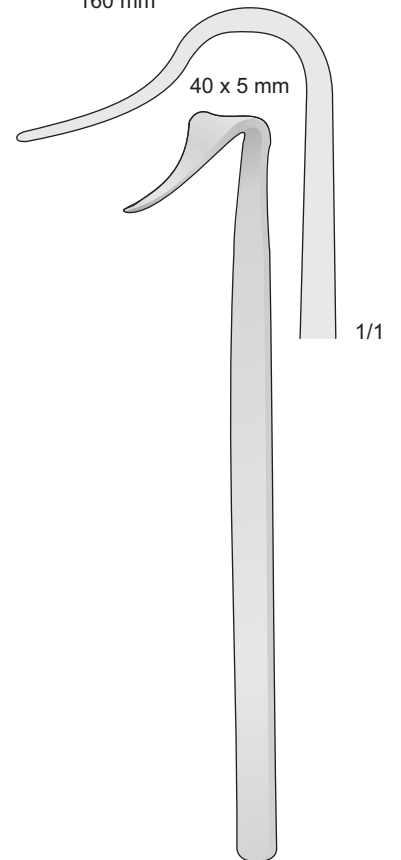

BLOUNT
FK-27
175 mm

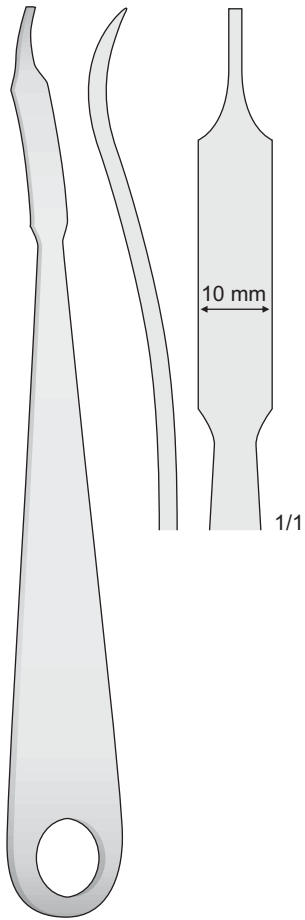

FK-51
220 mm

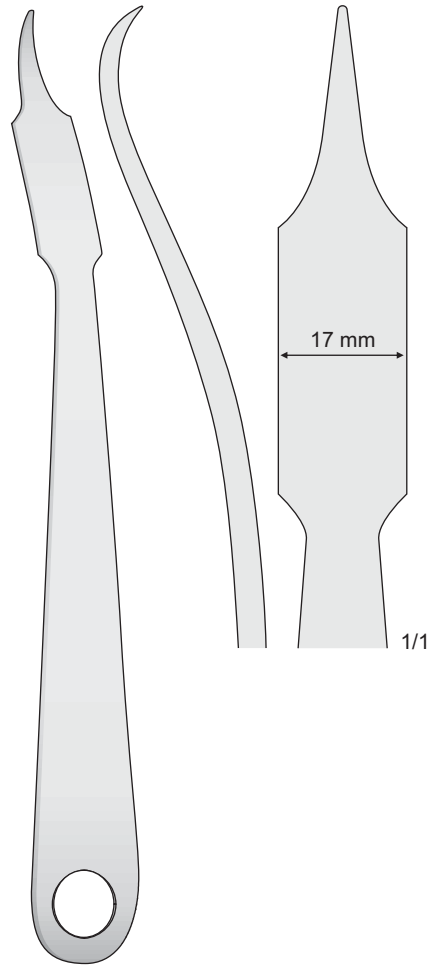

FK-52
240 mm

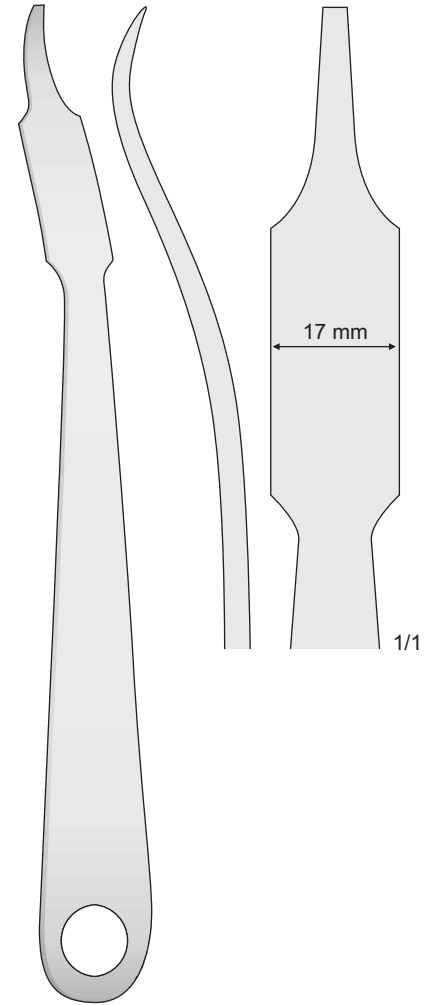

FK-53
240 mm

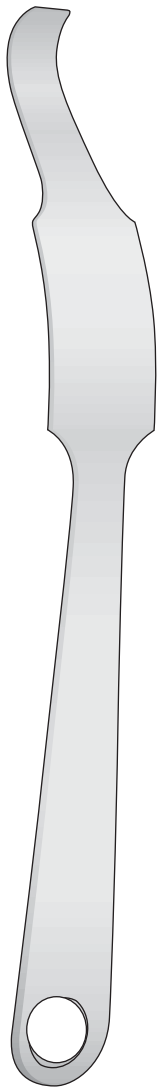

HOHMANN
FK-54/FK-55

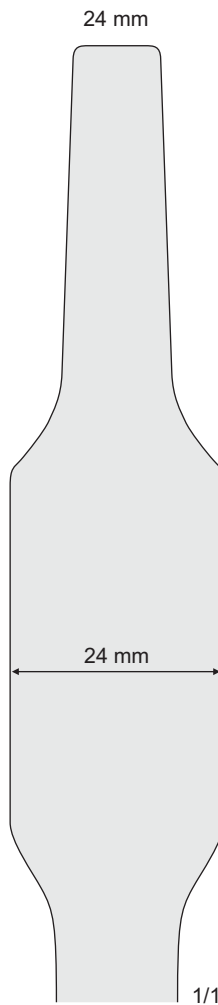

FK-54
260 mm

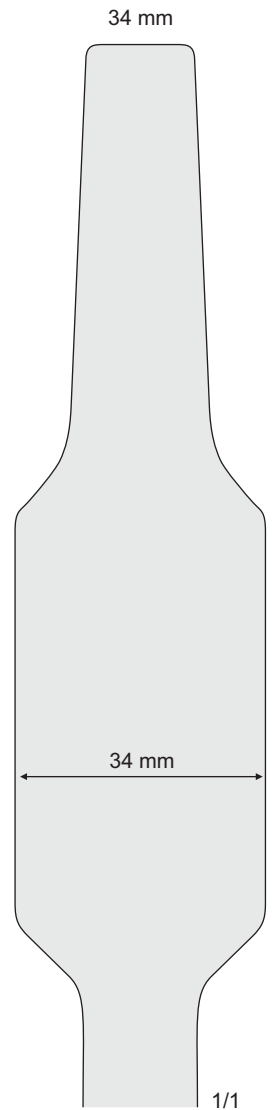

FK-55
285 mm

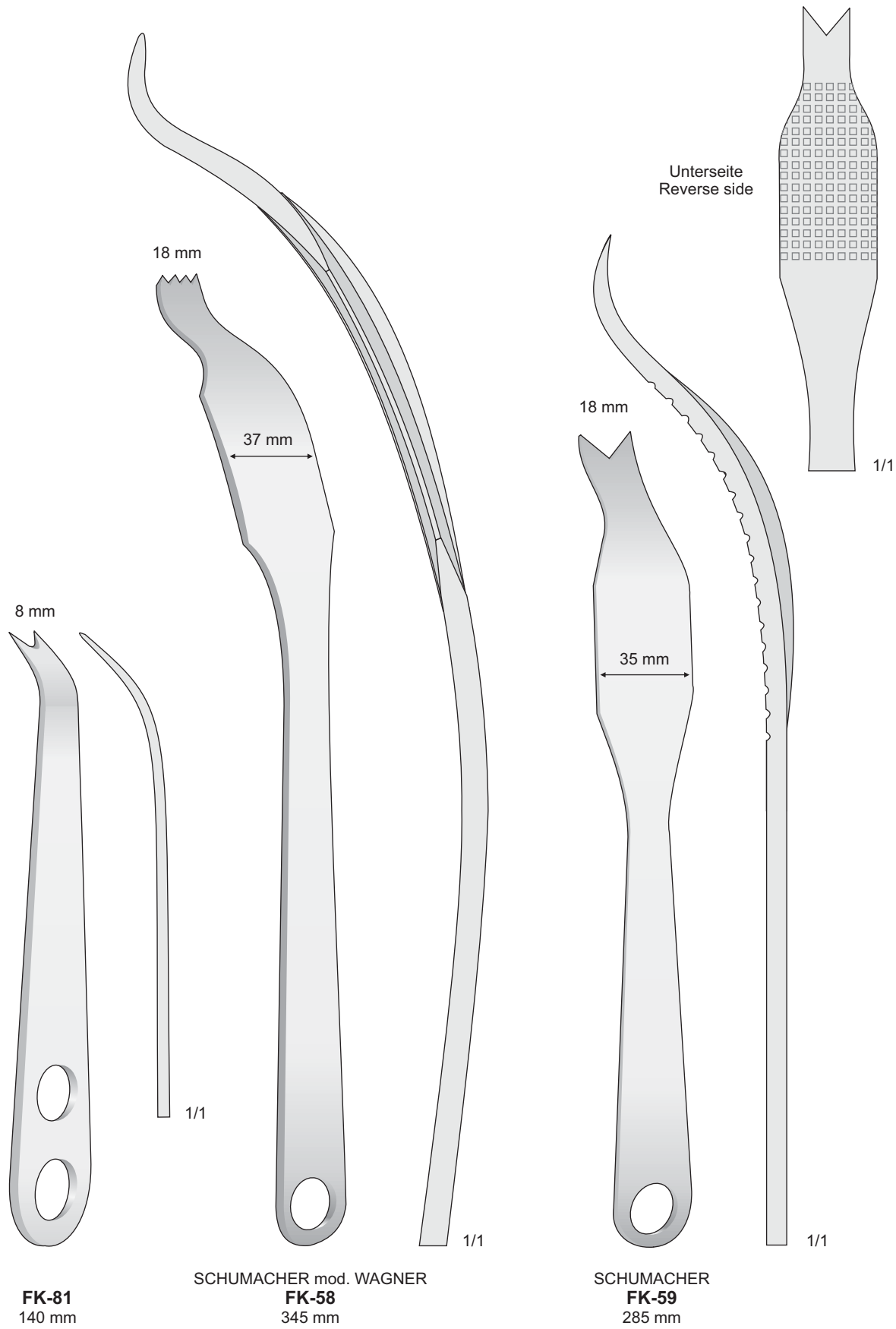

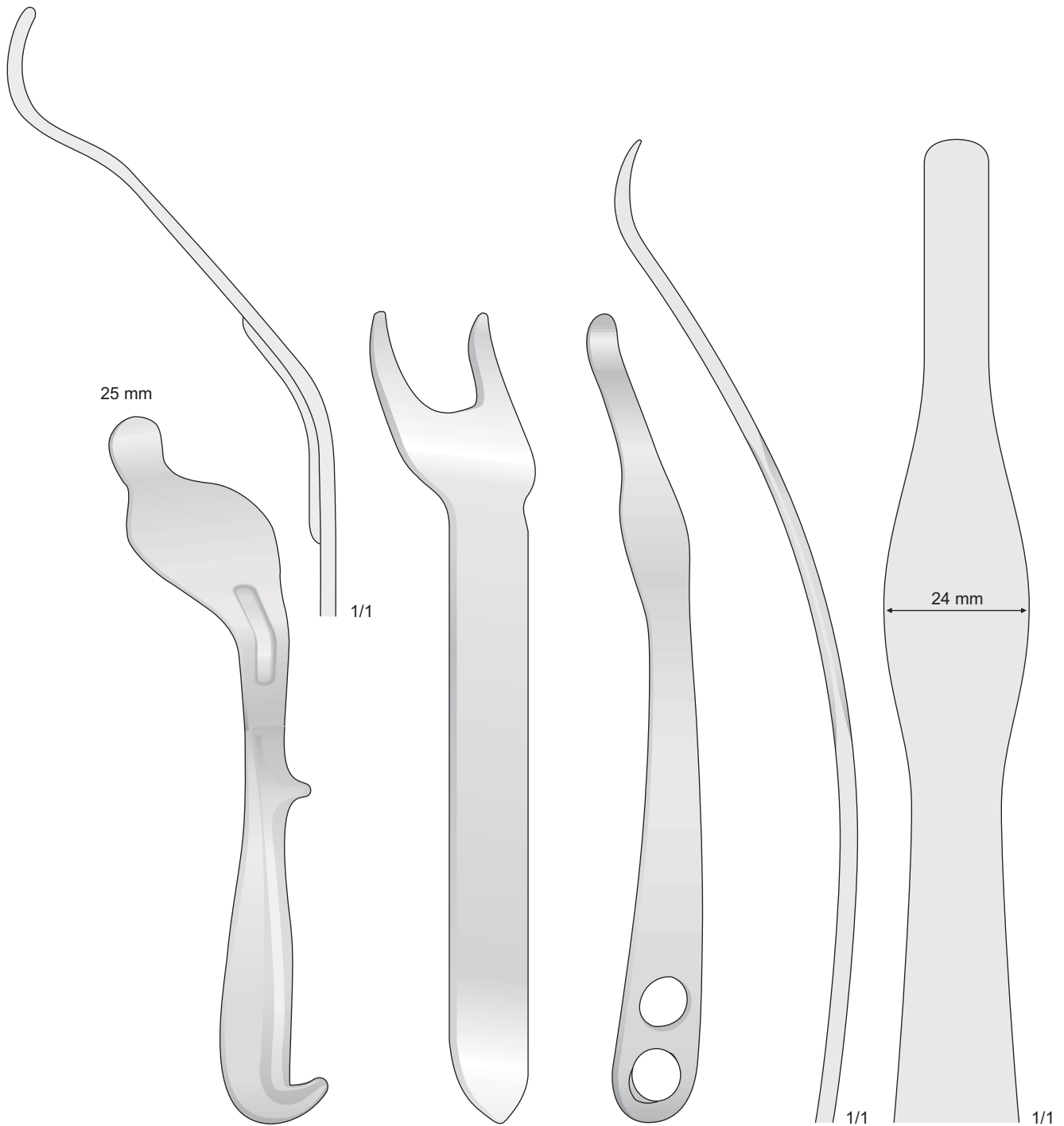

BENNETT
FK-176 43 mm
FK-179 60 mm
 240 mm

BLOUNT
FK-93
 260 mm

FK-56
 260 mm

11

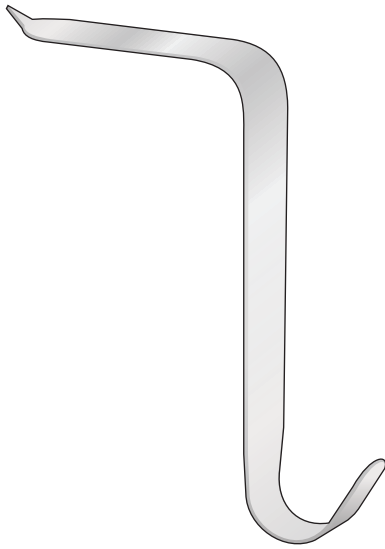

TAYLOR
FK-168 75 x 30 mm
FK-169 100 x 30 mm
165 mm

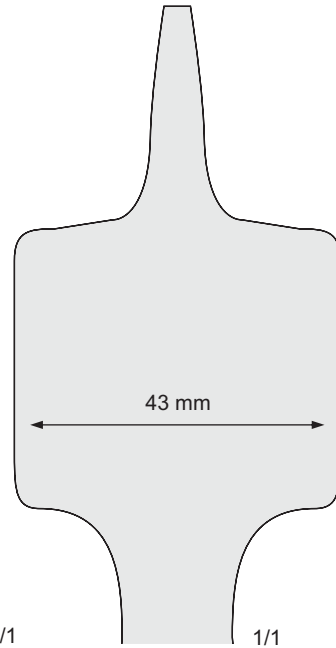
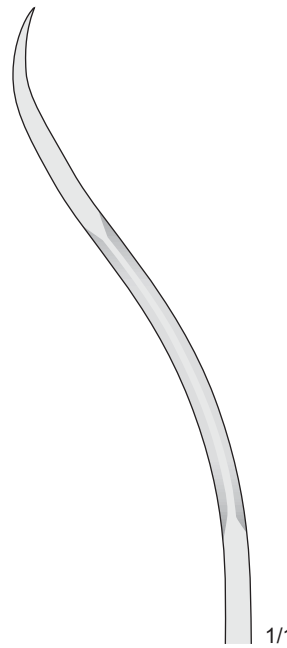

FK-57
240 mm

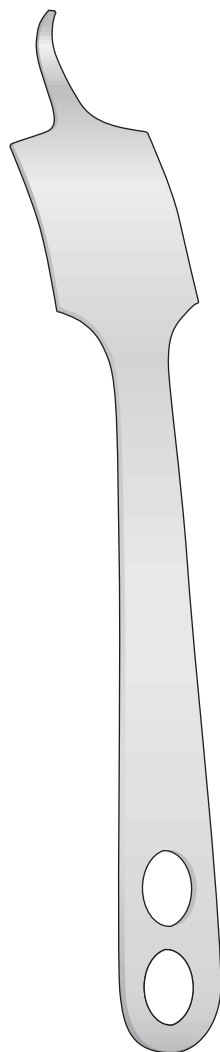
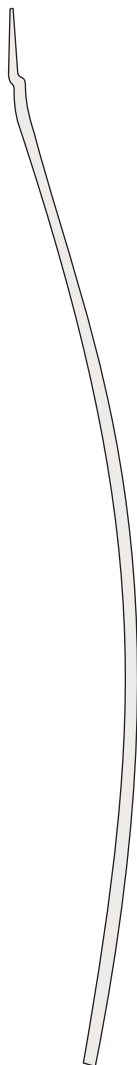
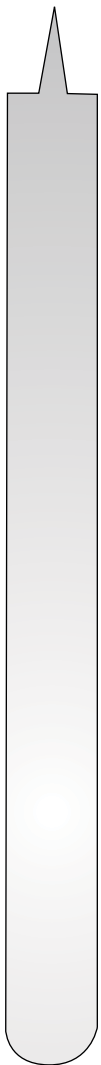

FK-164
250 mm

HOHMANN
FK-47/FK-57
240 mm

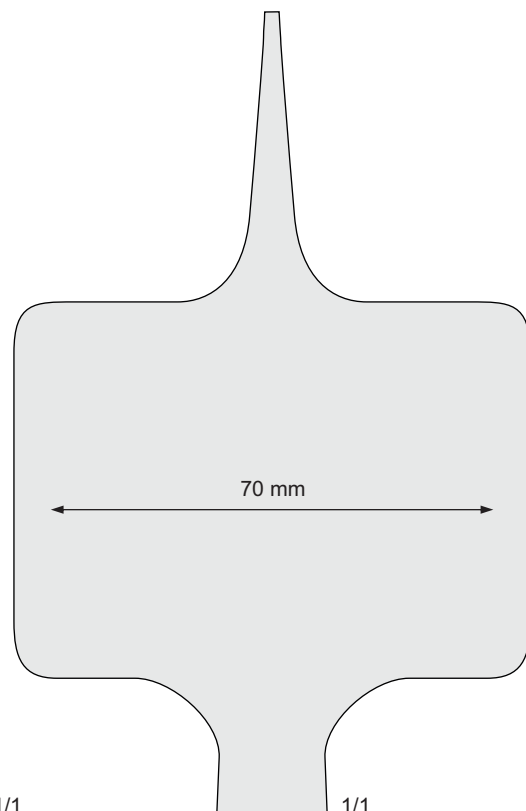
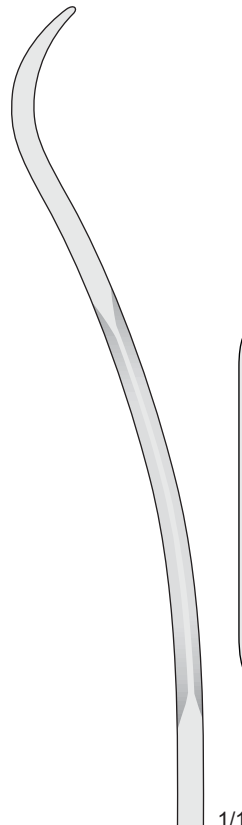

FK-47
240 mm



WEST
185 mm



**BABBUSH
KO-20**
180 mm

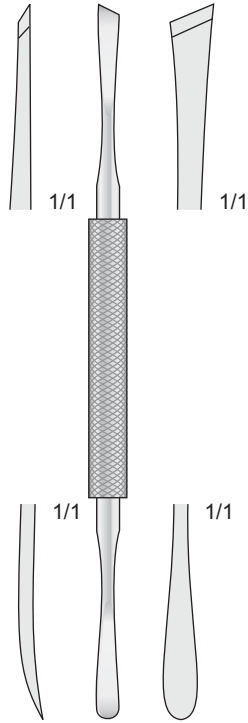

MEAD
165 mm

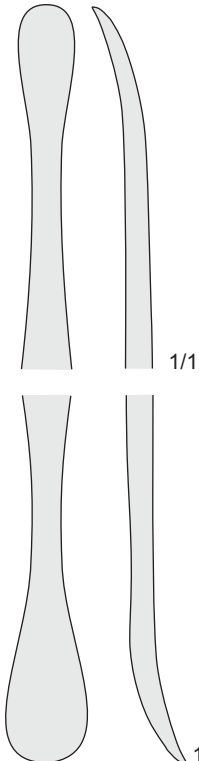

**SELDIN
KO-23**
195 mm



**ALDERDYCE
KO-39**
210 mm

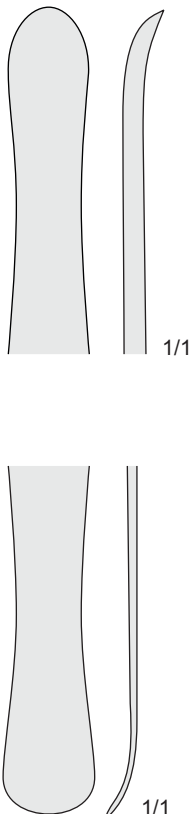

**SELDIN
KO-22**
190 mm

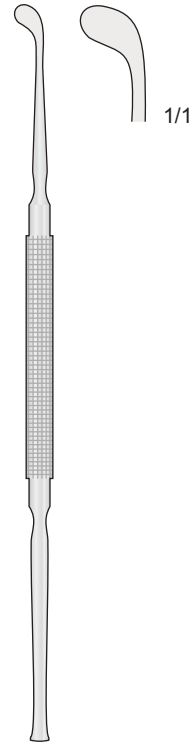

**FREER
FR-15**
190 mm

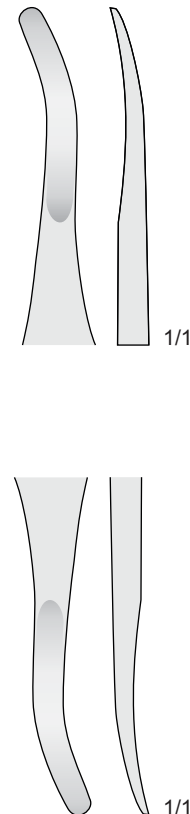

**LANGENBECK
FK-12**
200 mm

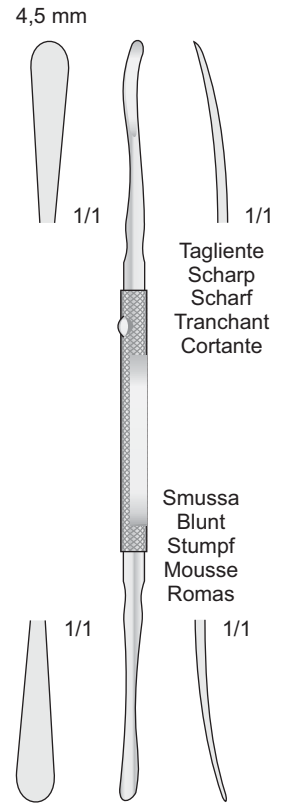

4 mm



DO-244
200 mm

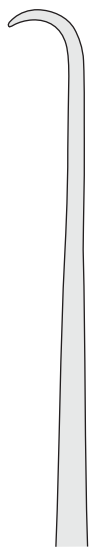

1/1

COTTLE DO-60
220 mm

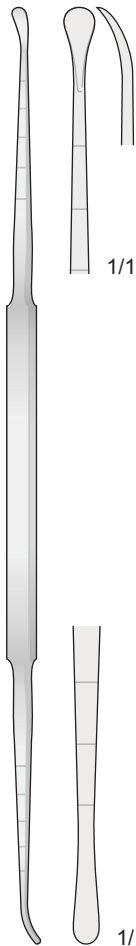

1/1

MASING DO-47
210 mm



1/1

COTTLE DO-111
210 mm

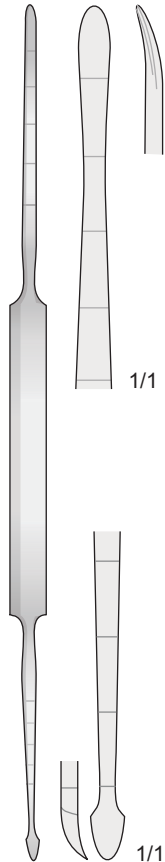

1/1

SALZBURG DO-240
245 mm



5 mm

Tagliente
Sharp
Scharf
Tranchant
Cortante

1/1

Smussa
Blunt
Stumpf
Mousse
Romas

1/1

SALZBURG DO-241
245 mm



5 mm

Tagliente
Sharp
Scharf
Tranchant
Cortante

1/1

Smussa
Blunt
Stumpf
Mousse
Romas

1/1

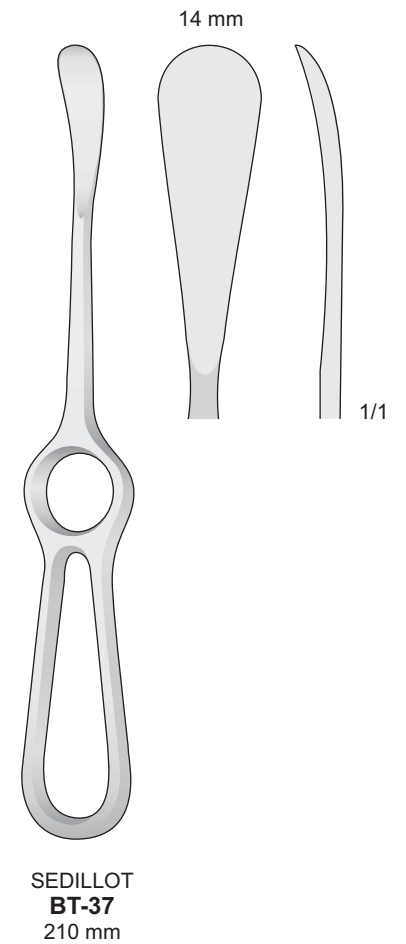
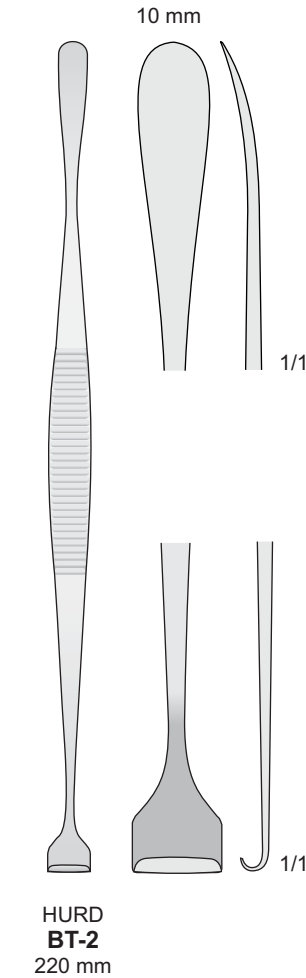
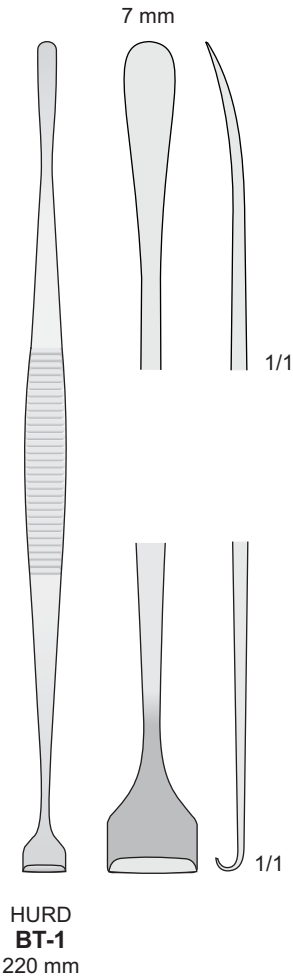
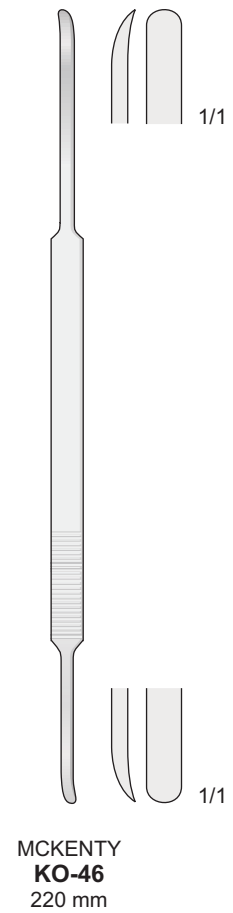
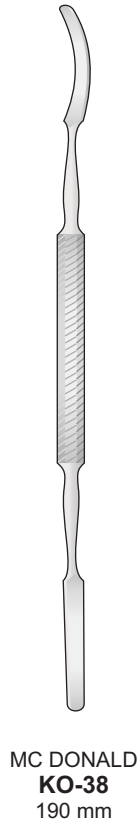

Periosteal elevators
Taglienti
Sharp
Scharf
Tranchant
Cortante

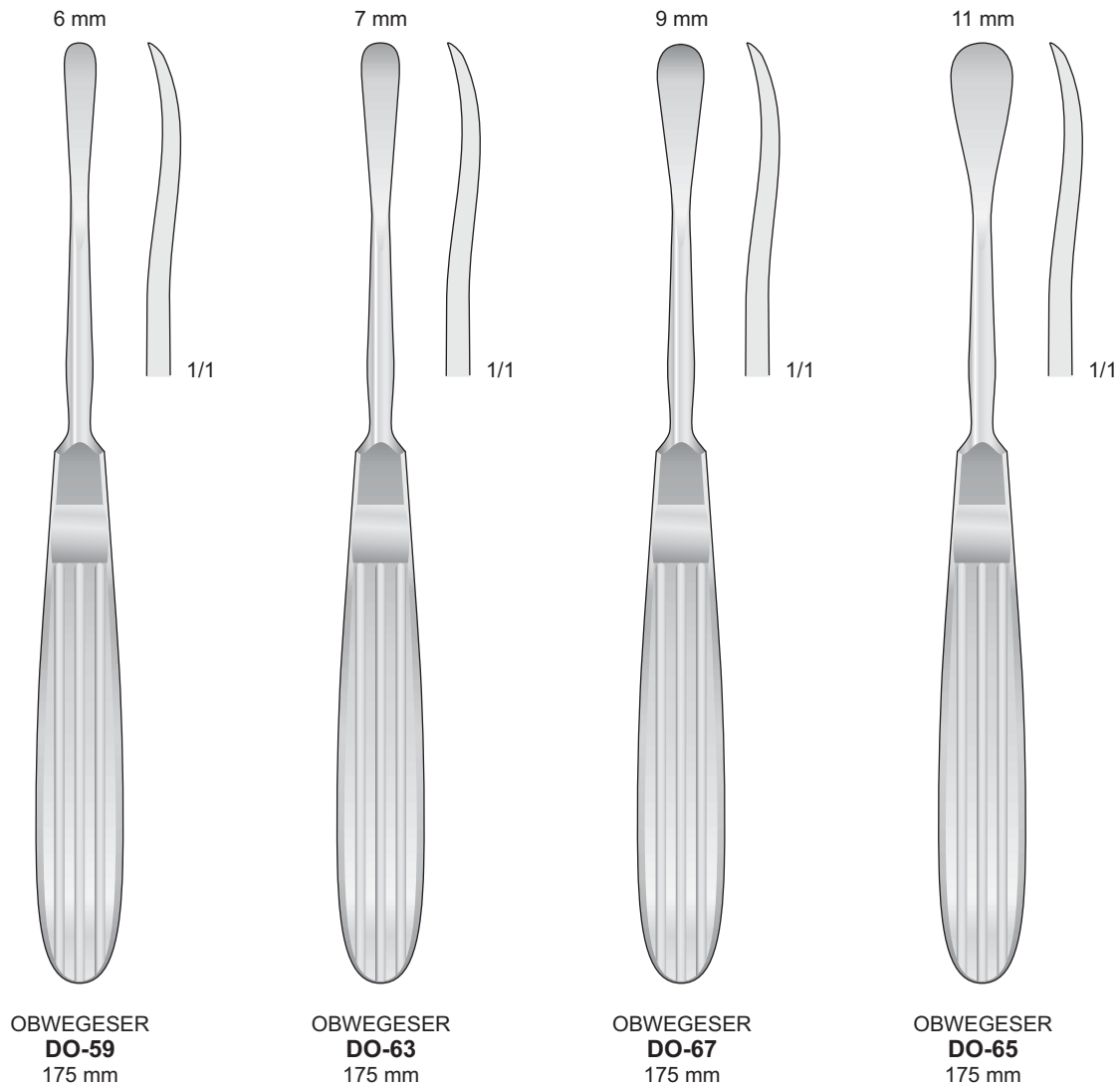

Sinistra, tagliente
Left, sharp
Links, Scharf
À gauche, tranchant
A la izquierda, cortante

Destra, tagliente
Right, sharp
Rechts, Scharf
À droite, tranchant
A la derecha, cortante

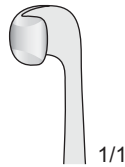

DO-68

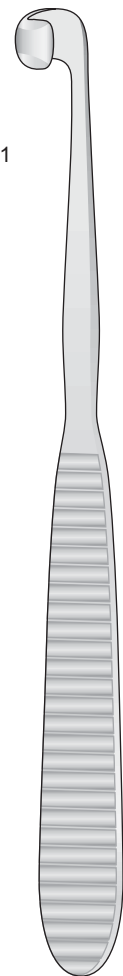

**OBWEGESER
DO-68/DO-69**
190 mm

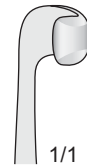

DO-69

5 mm

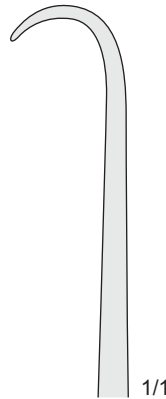

DO-90
200 mm

7 mm

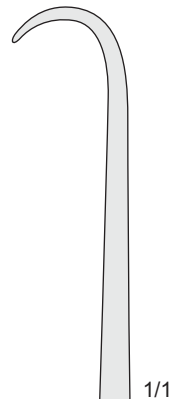

DO-117
200 mm

Taglienti - Sharp
Scharf - Tranchant - Cortante

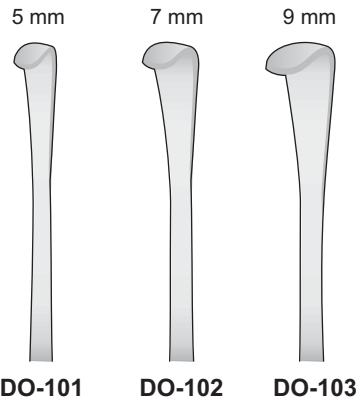

OBWEGESER
DO-101/DO-103
200 mm

Elevator

Smusso
Blunt
Stumpf
Mousse
Romas

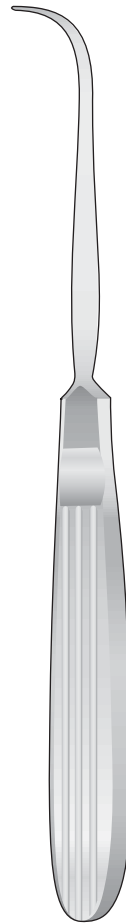

STEINHÄUSER
DO-106
185 mm

Repositioning fork

Tagliente
Sharp
Scharf
Tranchant
Cortante



STEINHÄUSER
DO-107
180 mm

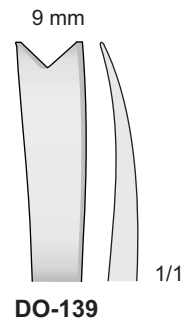
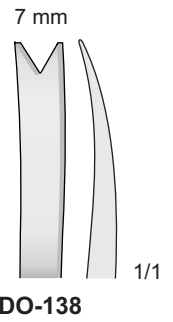

OBWEGESER
DO-138/DO-139
175 mm



CUSHING
FK-252
190 mm



ADSON
FK-260/FK-263
170 mm

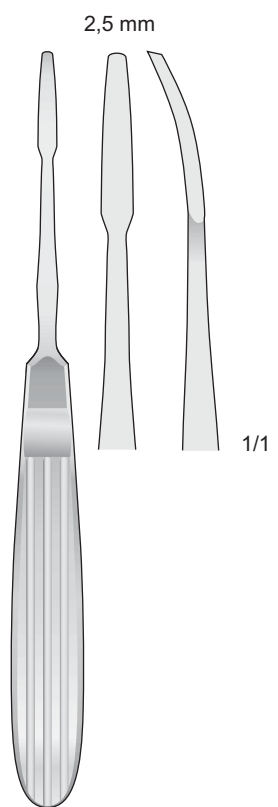
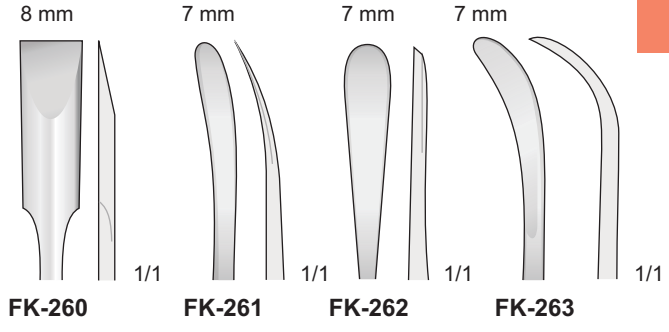

JOSEPH
FK-80
170 mm

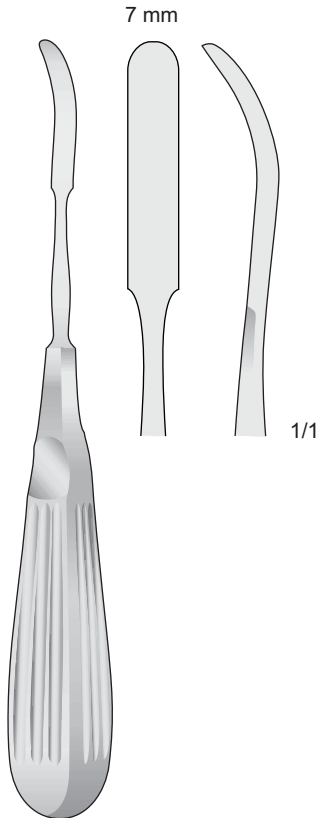

JOSEPH
FK-82
180 mm

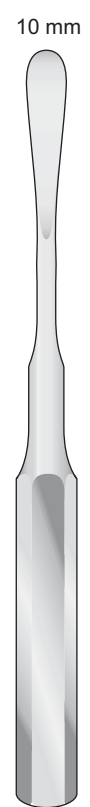

MOLT
MO-15
160 mm

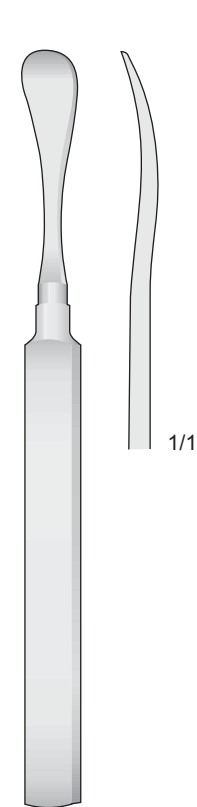

HENAHAN
BT-05/BT-07
175 mm

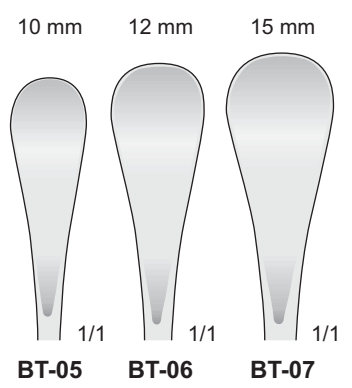

11

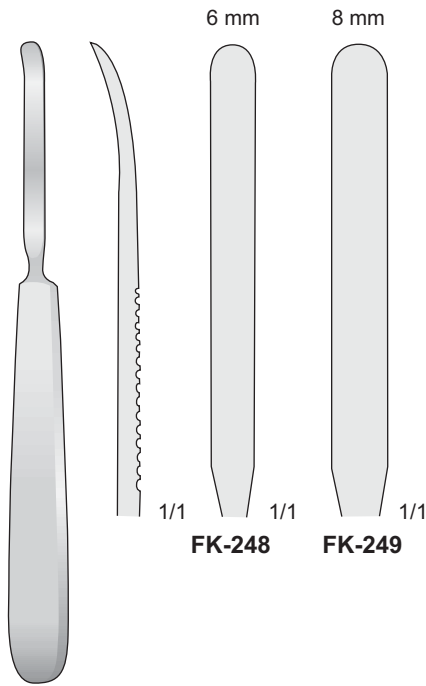

FK-248/FK-249
170 mm

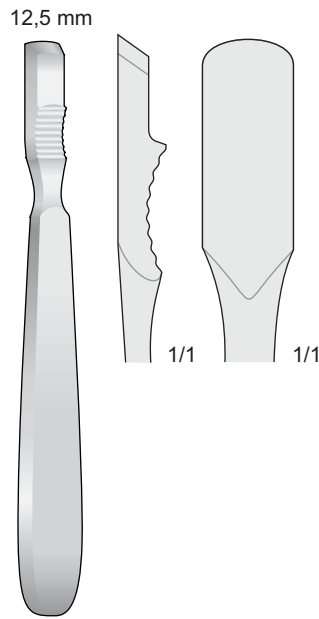

FARABEU FK-250
150 mm

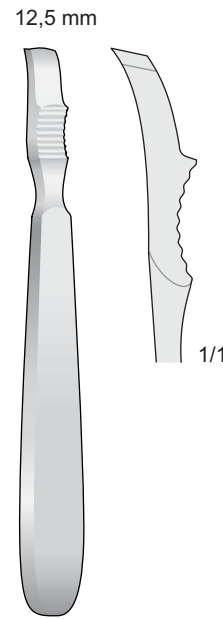

FARABEU FK-251
150 mm

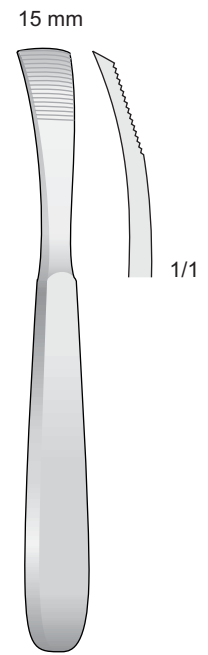

JANSEN FK-255
165 mm

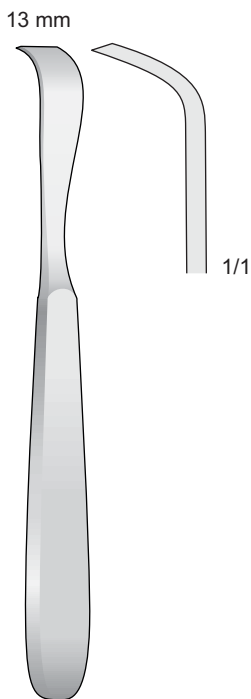

SCHNEIDER FK-258
175 mm

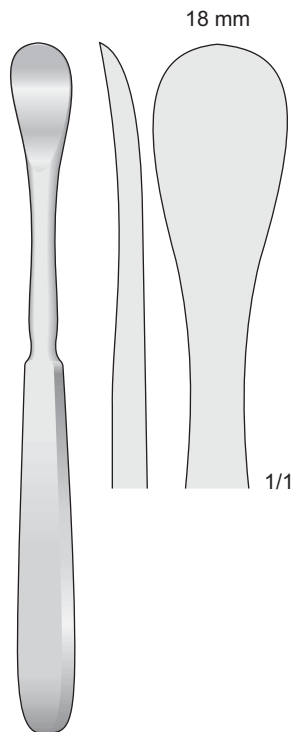

SEDILLOT FK-254
185 mm

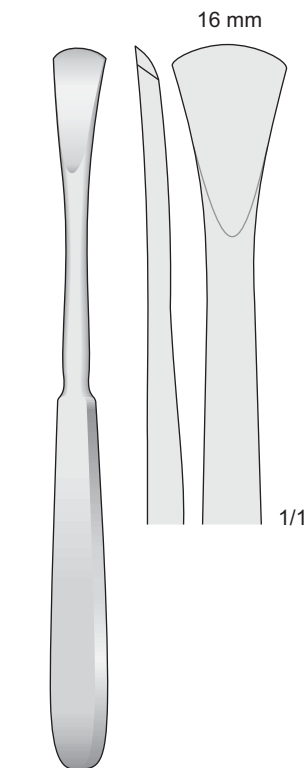

LANGENBECK FK-256
190 mm

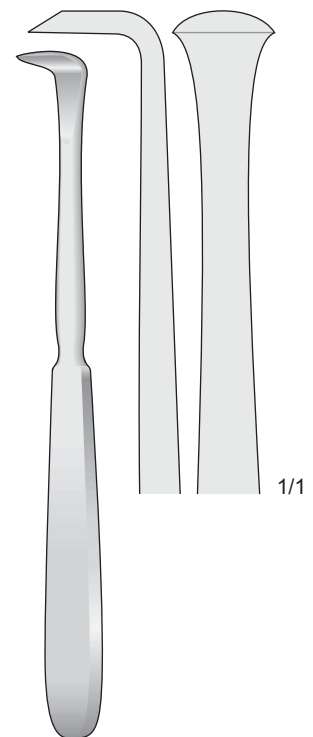

LANGENBECK FK-257
180 mm

Sinus
Hypophisectomia

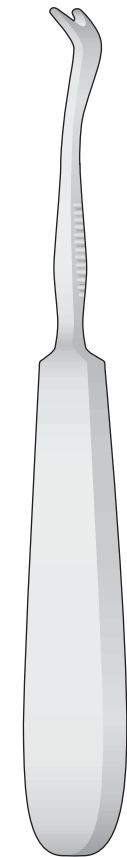

SEMB
FK-40/FK-44

Sinus and
Hypophisectomy

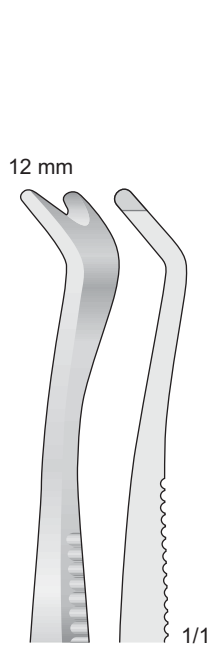

FK-40
190 mm

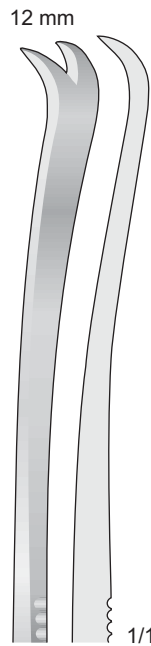

FK-41
230 mm

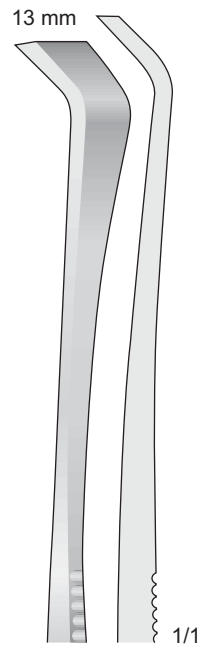

FK-42
230 mm

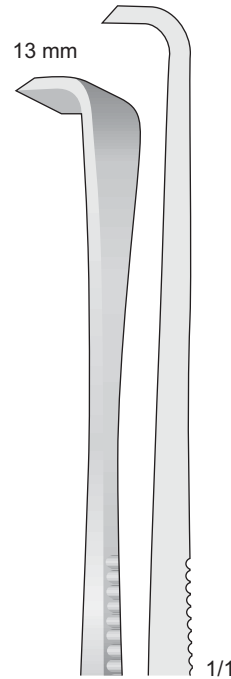

FK-43
230 mm

Elevation e dissezion
de apofisi zigomatica

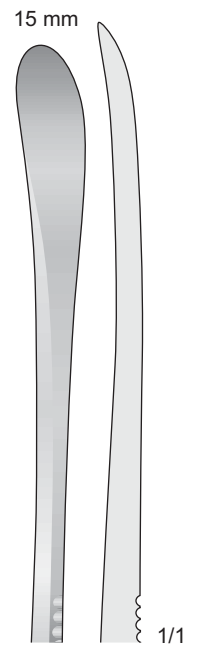

FK-44
230 mm

11

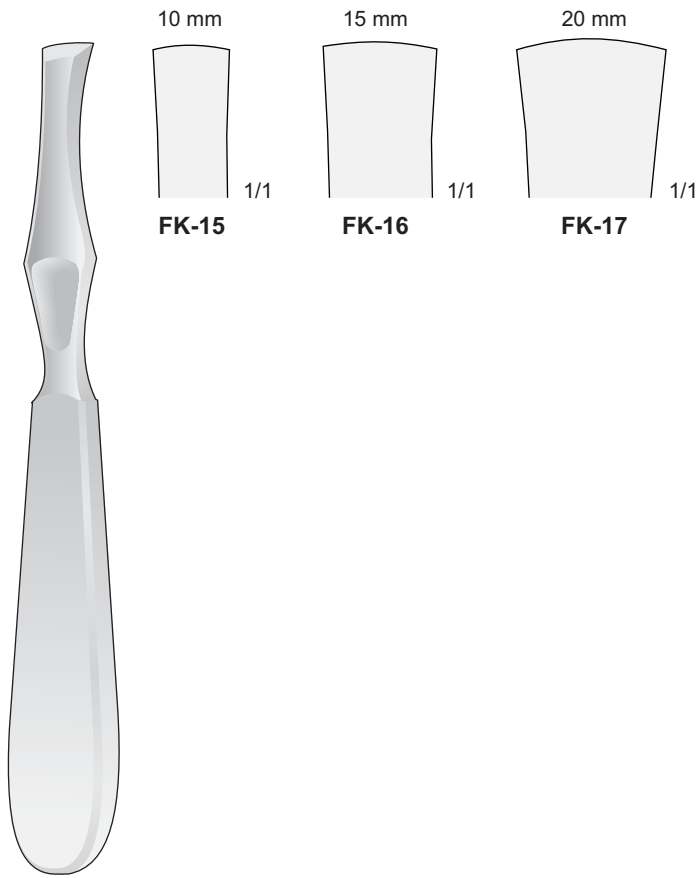

LAMBOTTE
FK-15/FK-17
205 mm

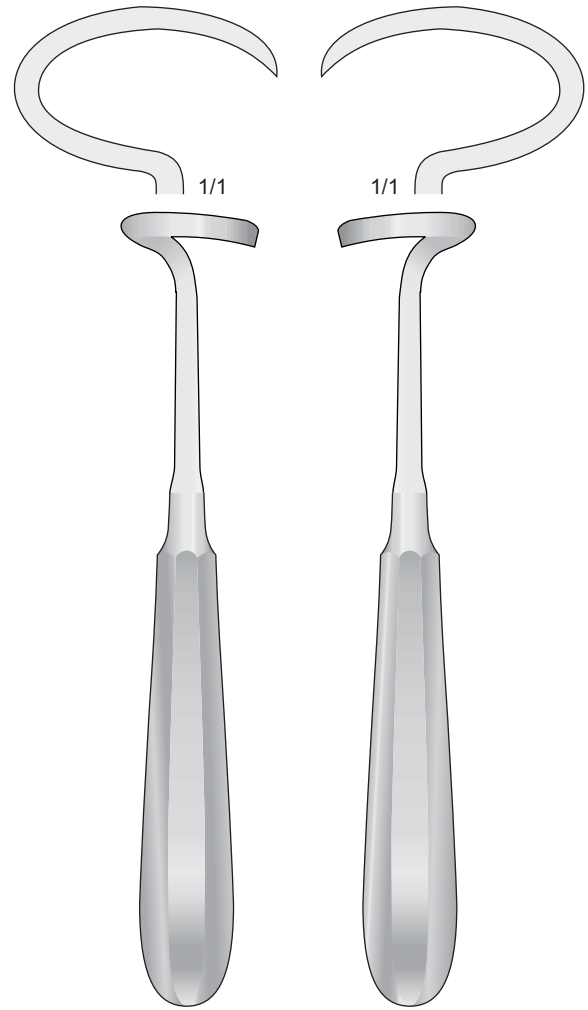

DOYEN
FK-18
180 mm

DOYEN
FK-19
180 mm

Con manico Ferrozell
With Ferrozell handle
Mit Ferrozellgriff
Avec poignée en Ferrozell
Con mango de Ferrozell

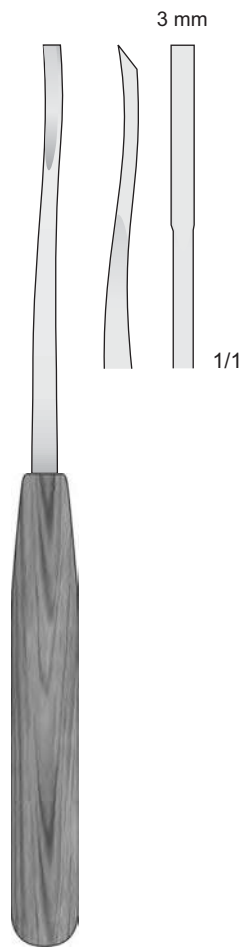

FK-234
180 mm

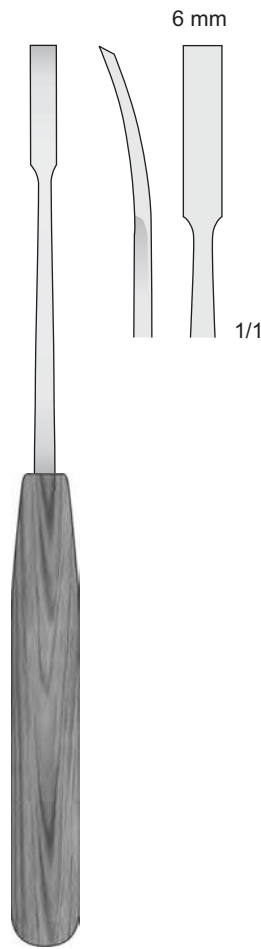

FK-230
190 mm



FK-232
190 mm

Con manico Ferrozell
 With Ferrozell handle
 Mit Ferrozellgriff
 Avec poignée en Ferrozell
 Con mango de Ferrozell

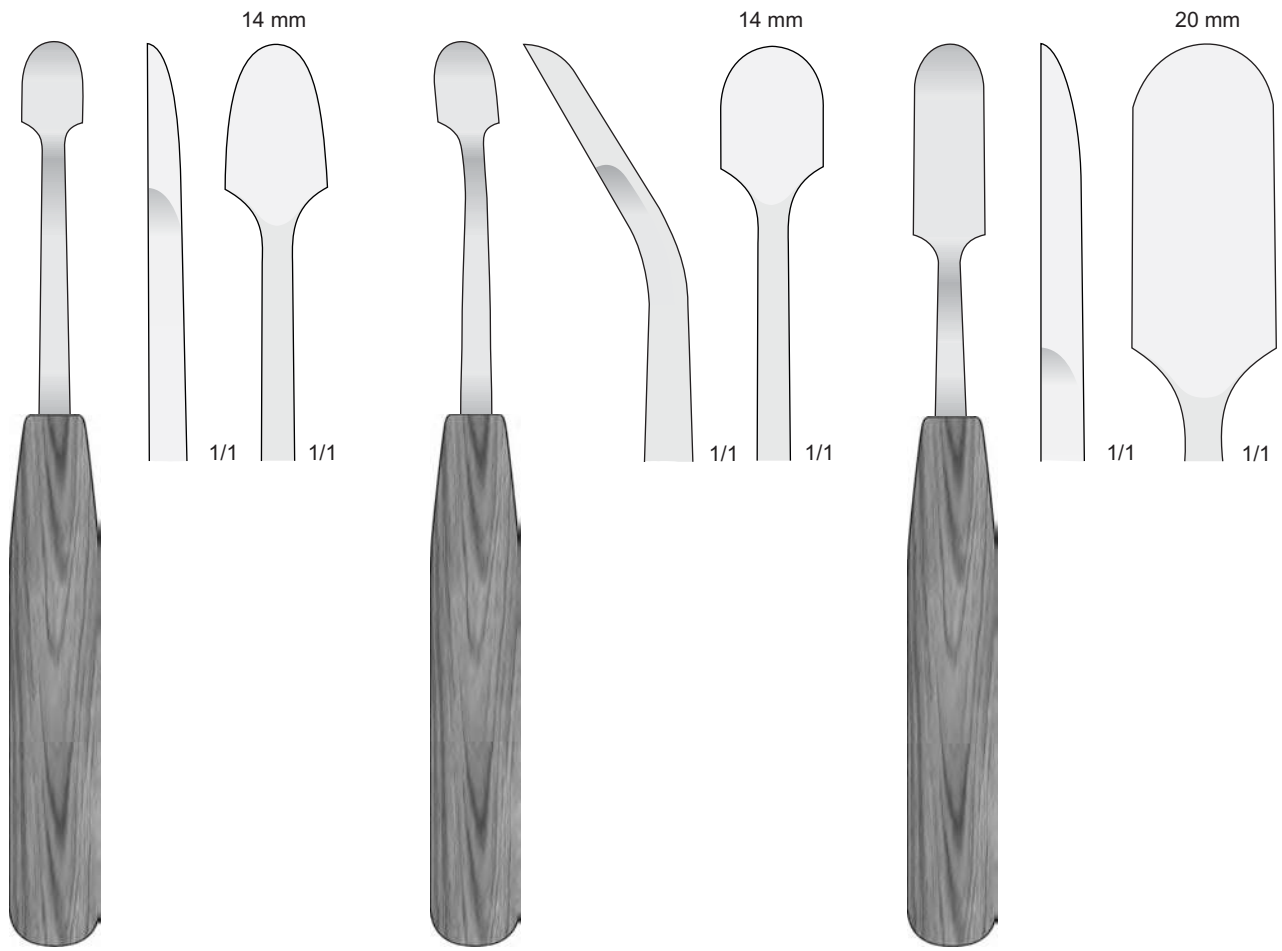

FK-238
200 mm

FK-240
200 mm

Con manico Ferrozell
With Ferrozell handle
Mit Ferrozellgriff
Avec poignée en Ferrozell
Con mango de Ferrozell

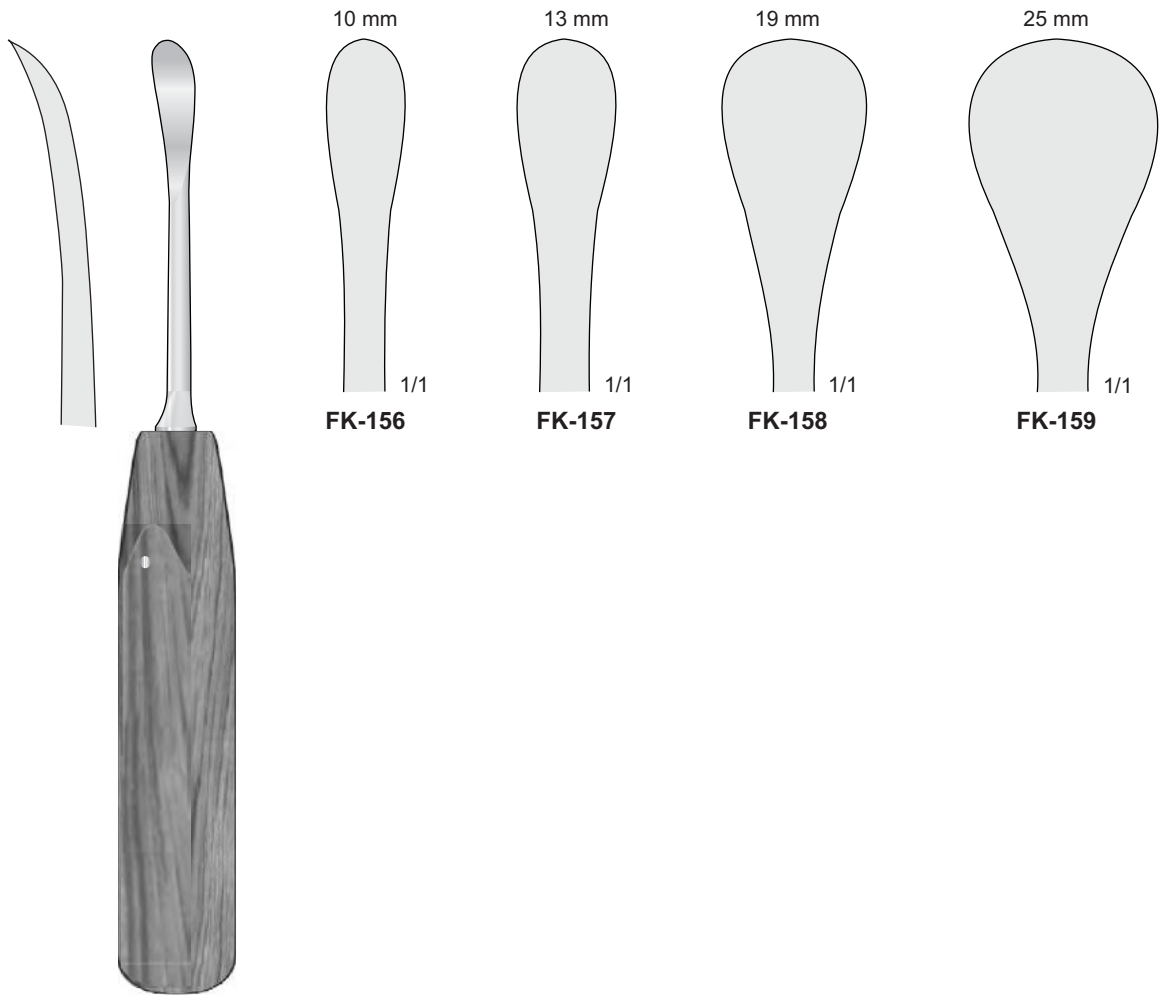

COBB
FK-156/FK-159
250 mm

Fig. 67

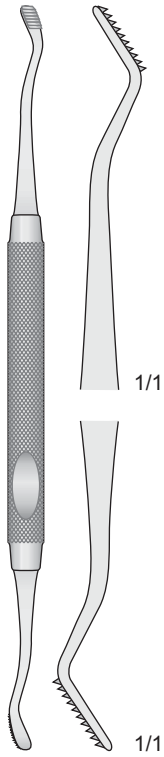

HOWARD DO-1
180 mm

Fig. 45

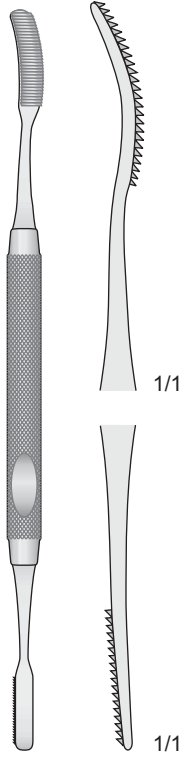

MILLER DO-2
185 mm

Fig. 52

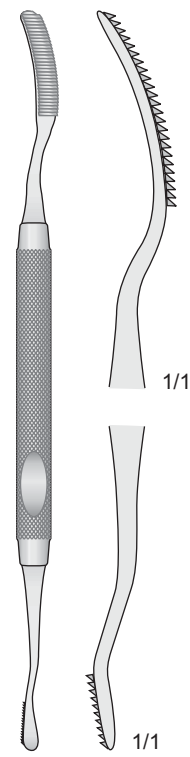

MILLER DO-3
180 mm

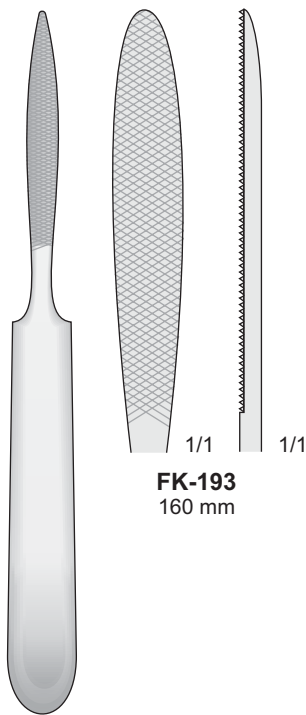

JOSEPH FK-193
160 mm

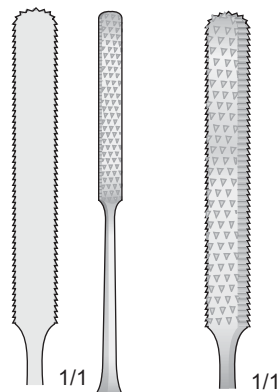

GALLAHER FK-194/FK-196
160 mm

FK-194
160 mm

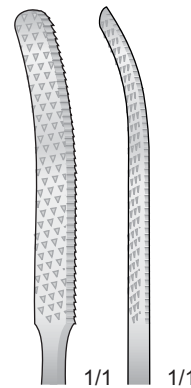

FK-195
160 mm

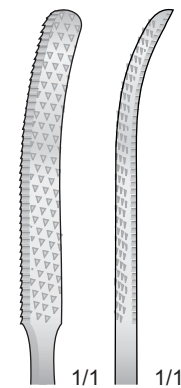

FK-196
160 mm

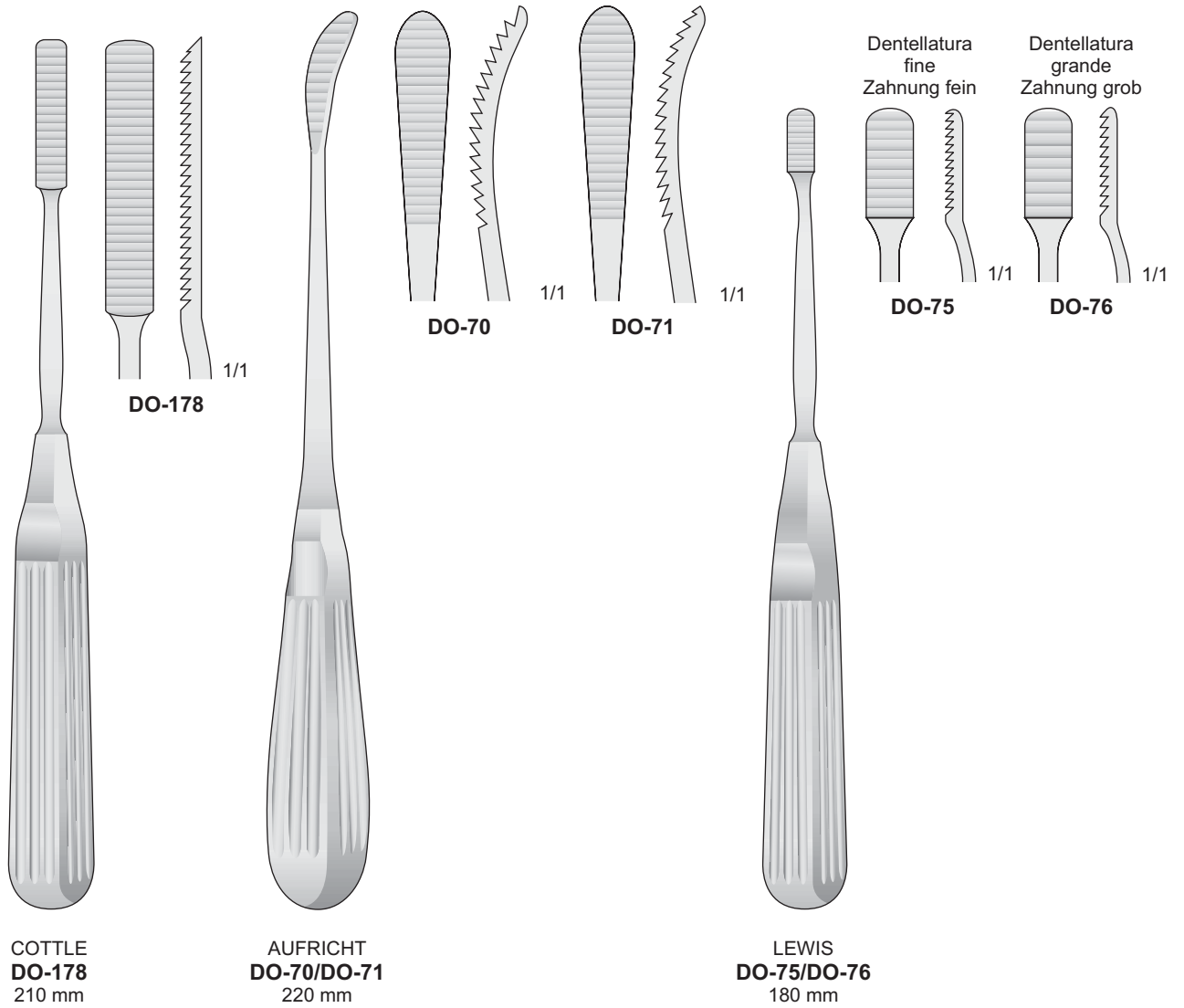

TC
TUNGSTEN
CARBIDE

Tungsten-Carbide Inserts
Mit Hartmetalleinsätzen
Plaquettes en carbure de tungstène
Plaquetas de carburo de tungsteno
Inserti in carburo di tungsteno

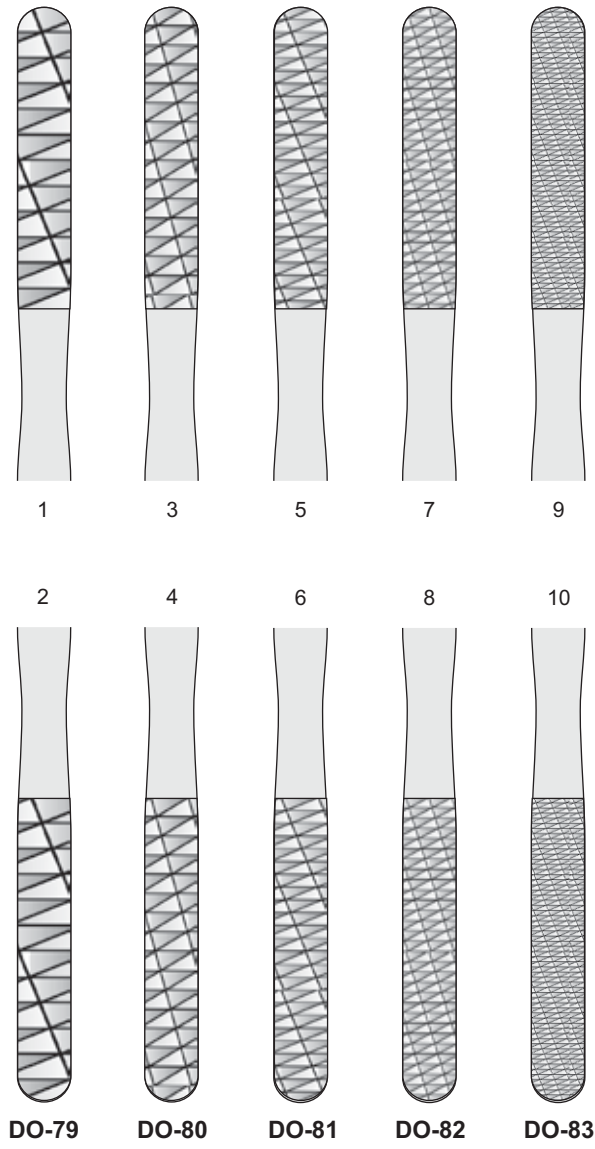
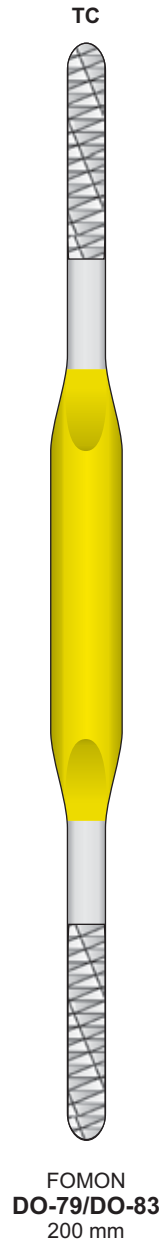

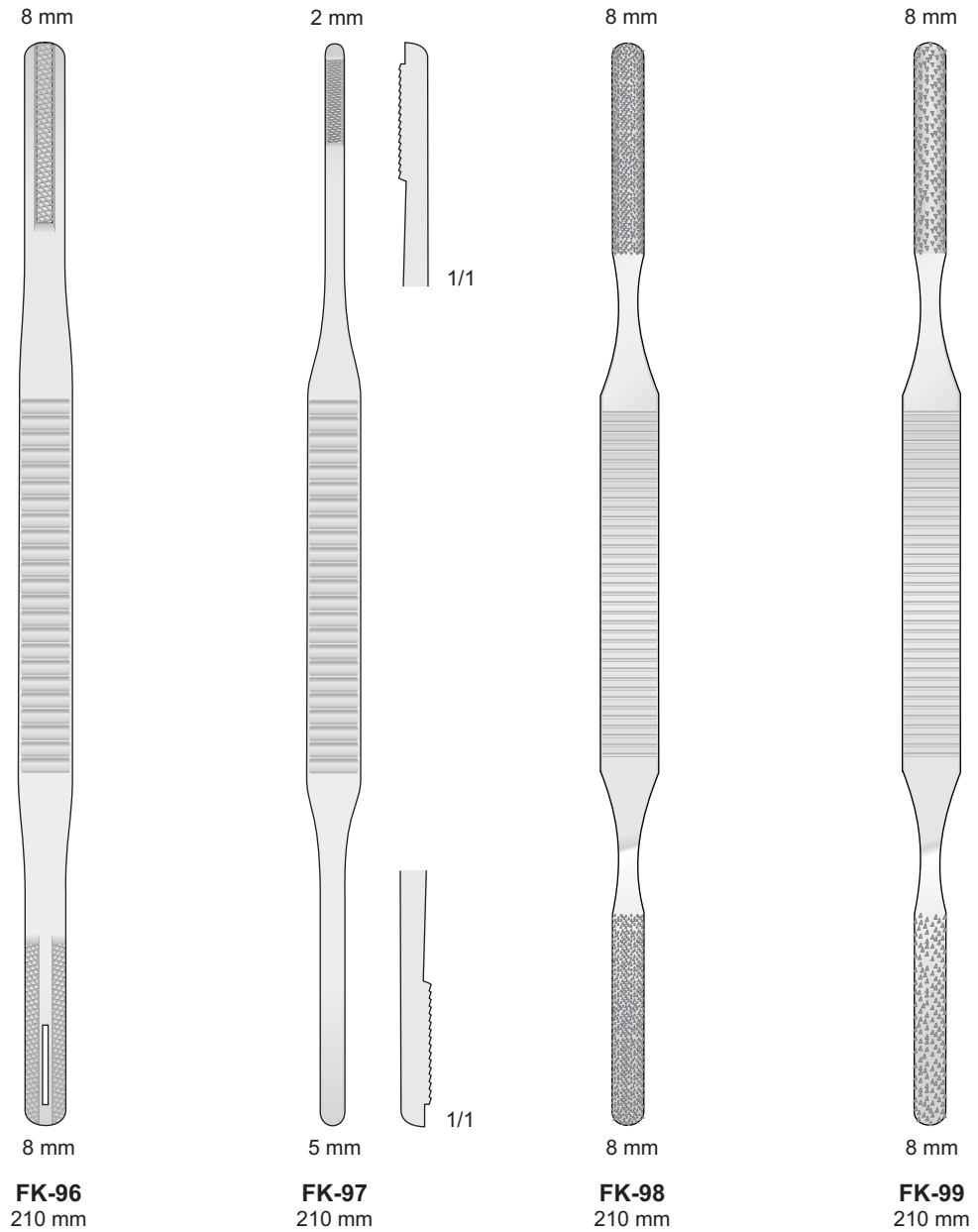

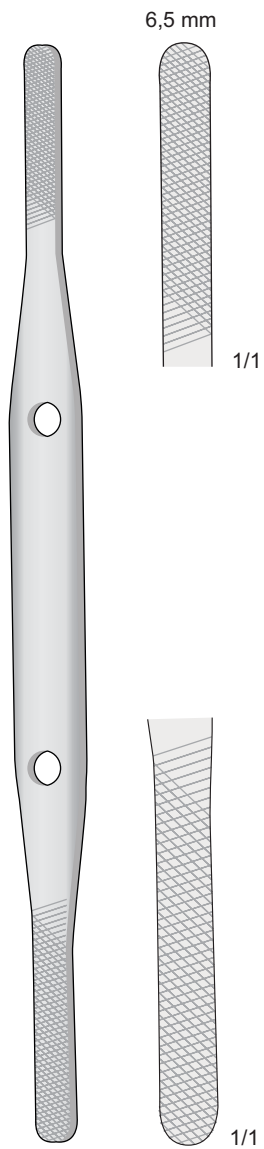

FOMON DO-168
210 mm

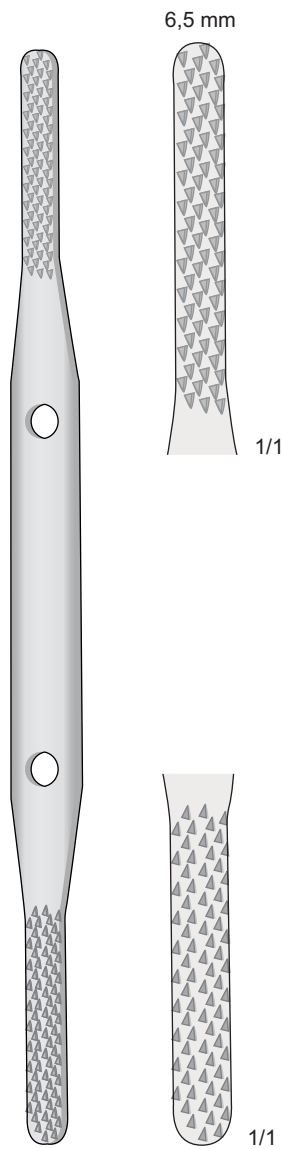

FOMON DO-169
210 mm

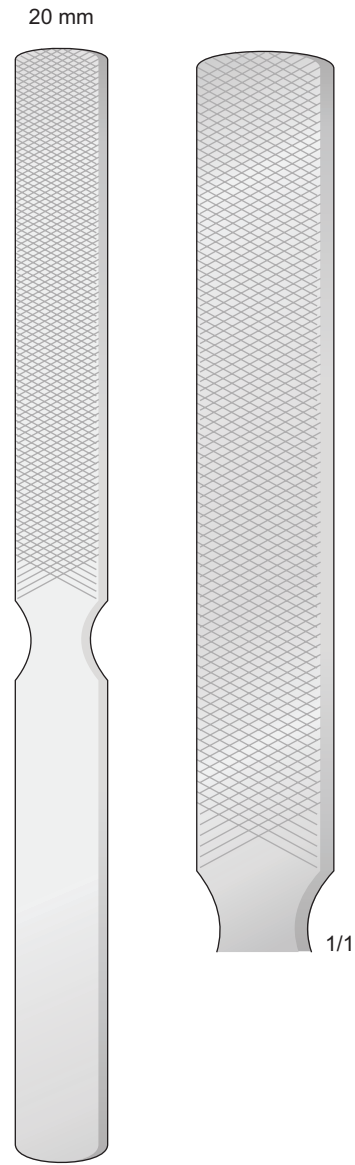

FK-119
220 mm

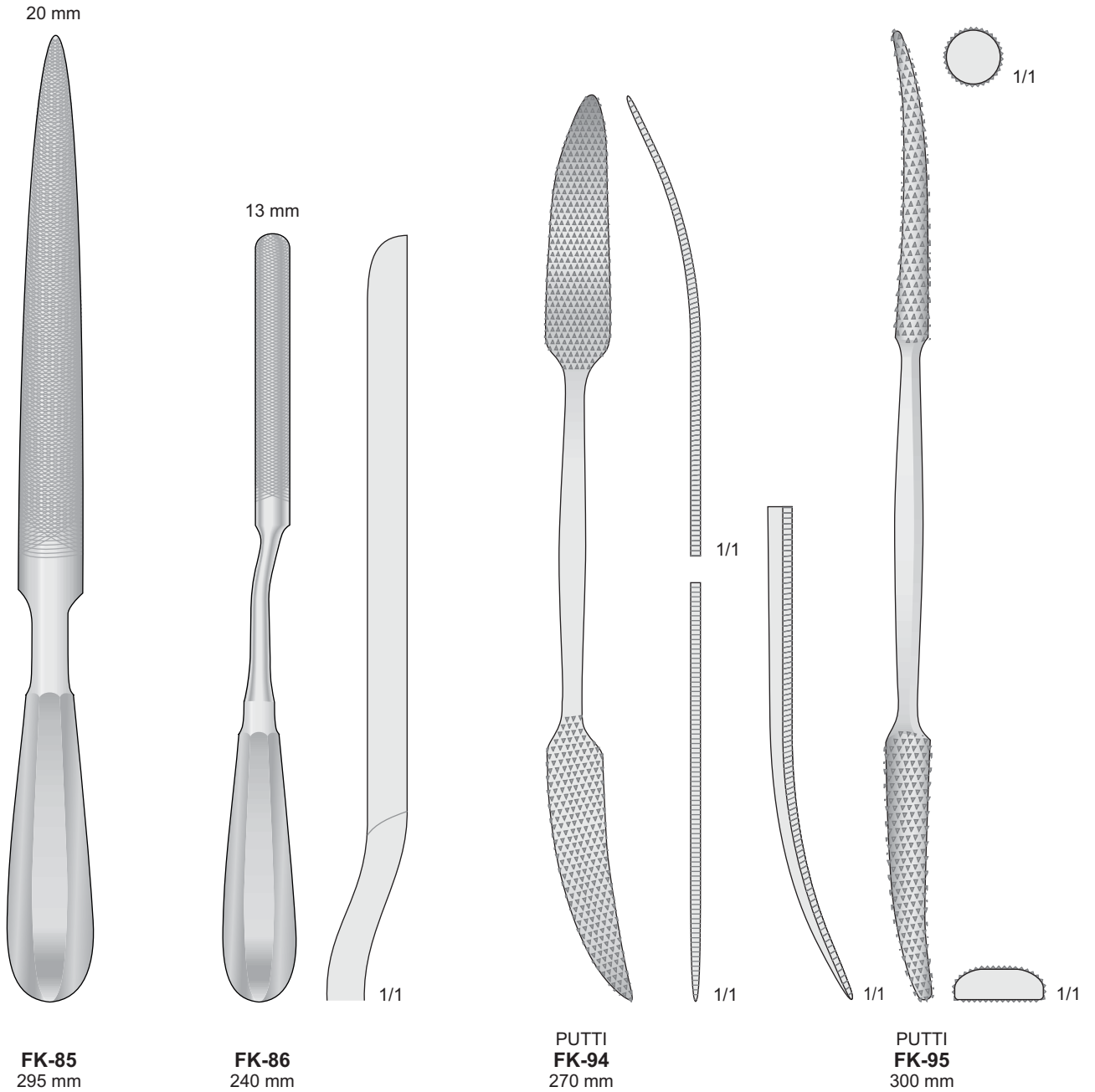

11

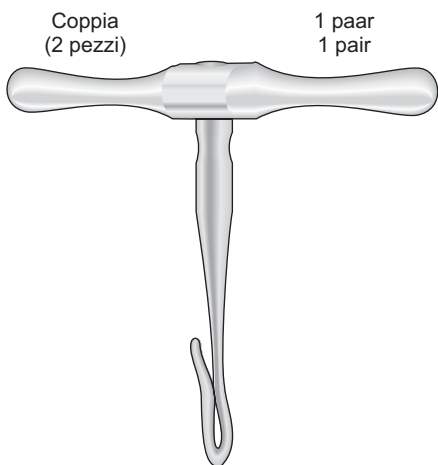

Coppia
(2 pezzi)

1 paar
1 pair

GIGLI
FK-11

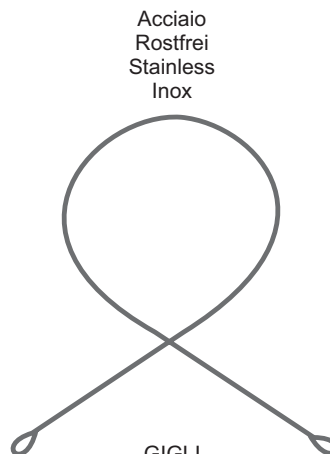

Acciaio
Rostfrei
Stainless
Inox

GIGLI
FK-13
300 mm
FK-14
500 mm

LS-300
Completa con 3 seghe
Complete with 3 saws
Komplett mit 3 Sägen
Complet avec 3 scies
Completo con 3 sierras

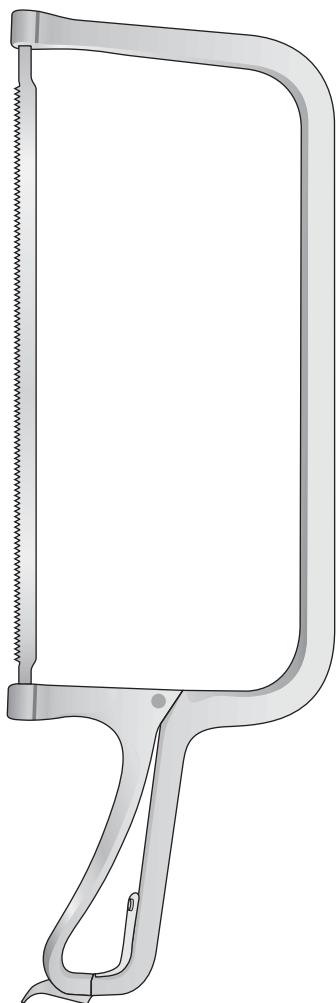

COLLIN
LS-300
390 mm

Fig.1 Fig.2 Fig.3

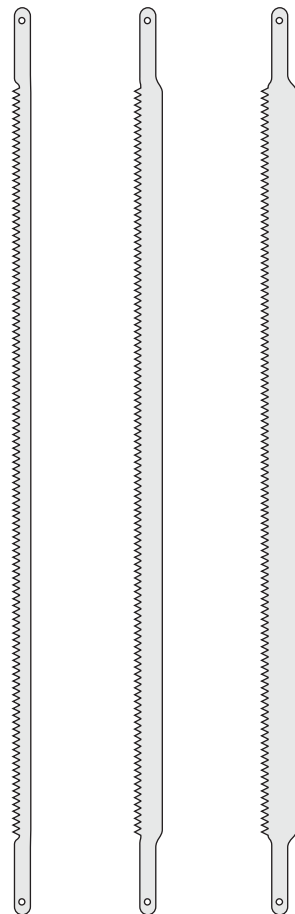

LS-301
280 mm

LS-302
280 mm

LS-303
280 mm



LINDEMANN
FK-243
200 mm

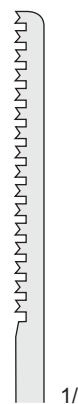

1/1



LANGENBECK
FK-244
235 mm

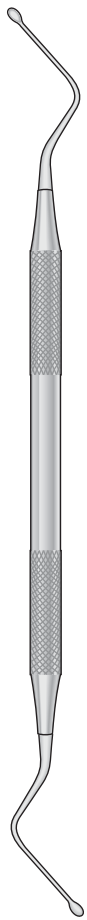

HEMINGWAY
C-1
175 mm

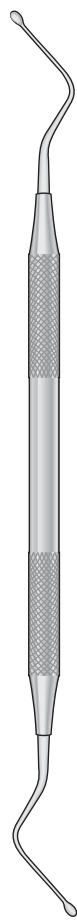

HEMINGWAY
C-2
175 mm

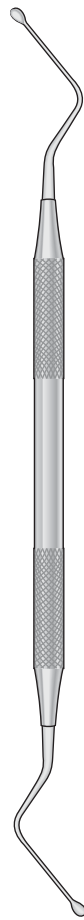

HEMINGWAY
C-3
175 mm

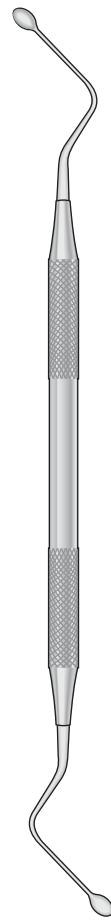

HEMINGWAY
C-4
175 mm

Fig. 1

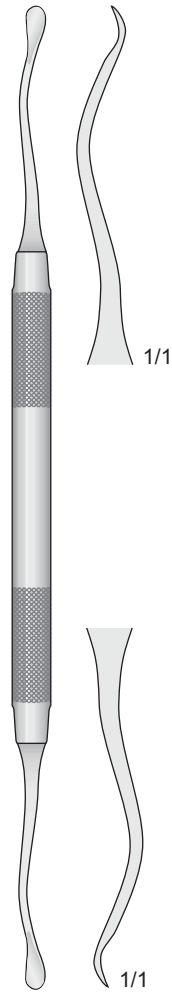

SL-1
200 mm

Fig. 2

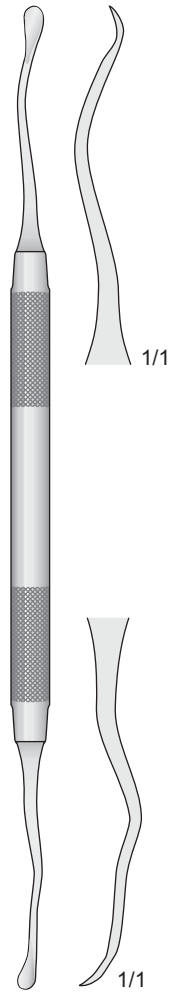

SL-2
195 mm

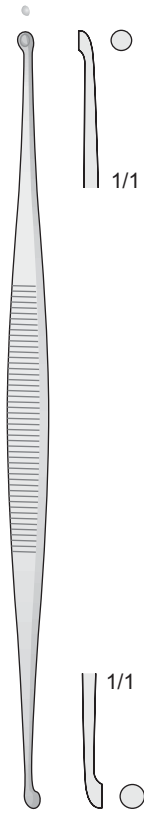

MARTINI
FK-70
 140 mm

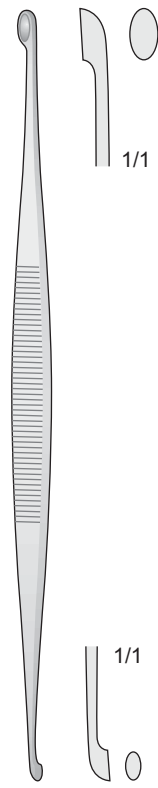

WILLIGER
FK-71
 145 mm

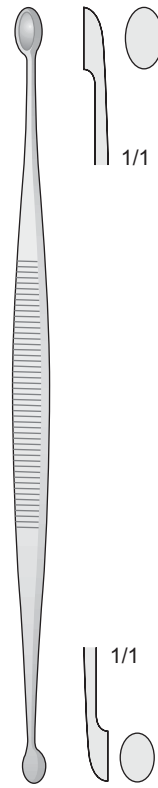

JACOBSON
FK-75
 140 mm

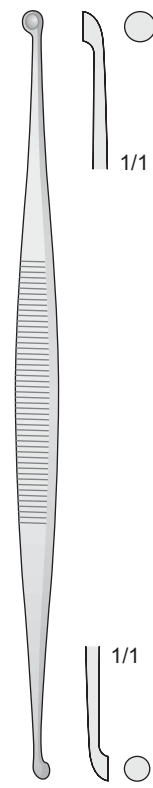

MARTINI
FK-76
 140 mm

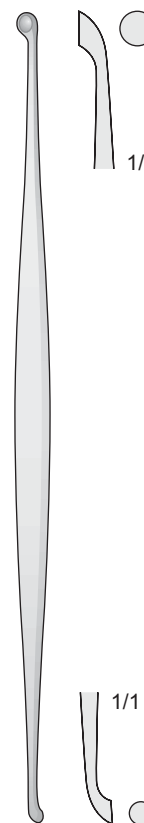

JANSEN
FK-77
 160 mm

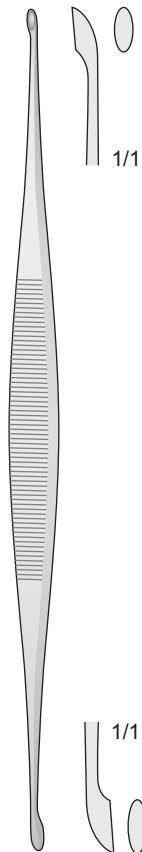

BARTH
FK-78
 180 mm

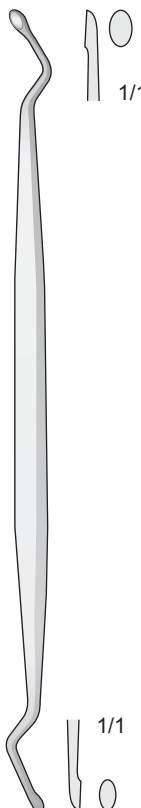

FK-83
 160 mm

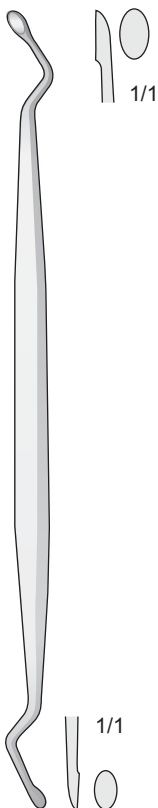

JANSEN
FK-84
 160 mm

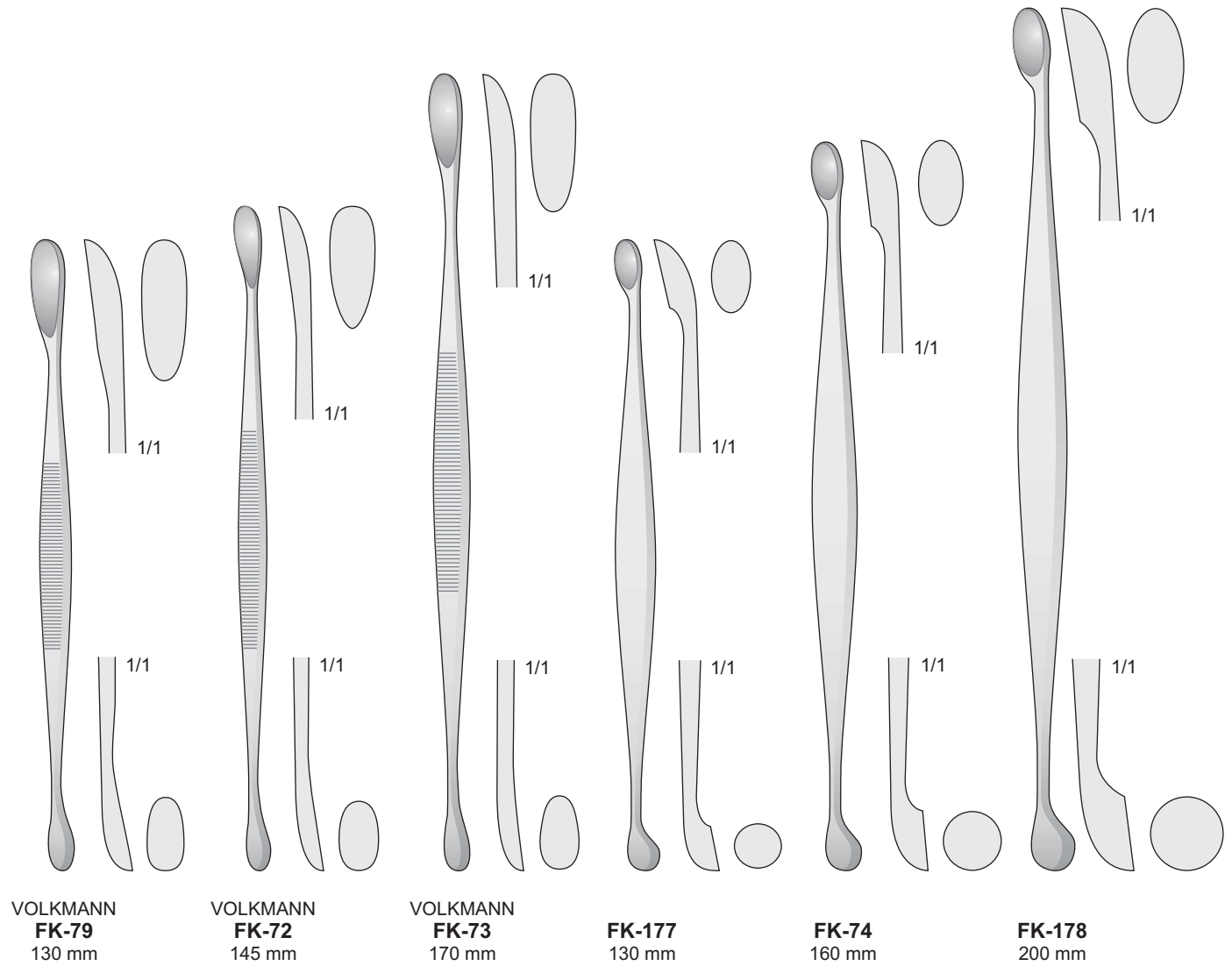

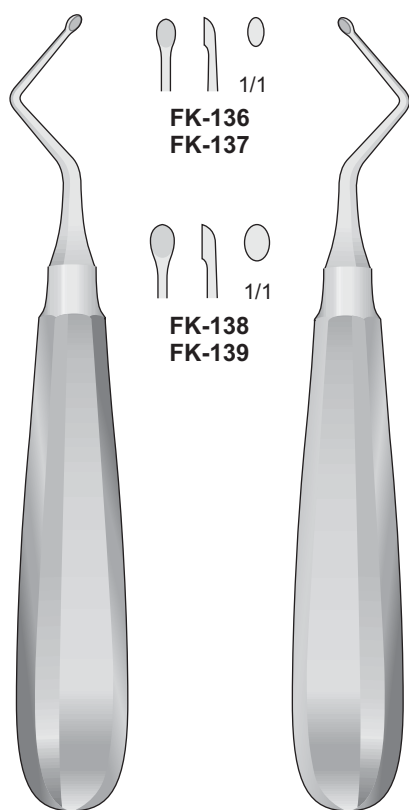

KERPEL
FK-136
FK-138
 145 mm

KERPEL
FK-137
FK-139
 145 mm

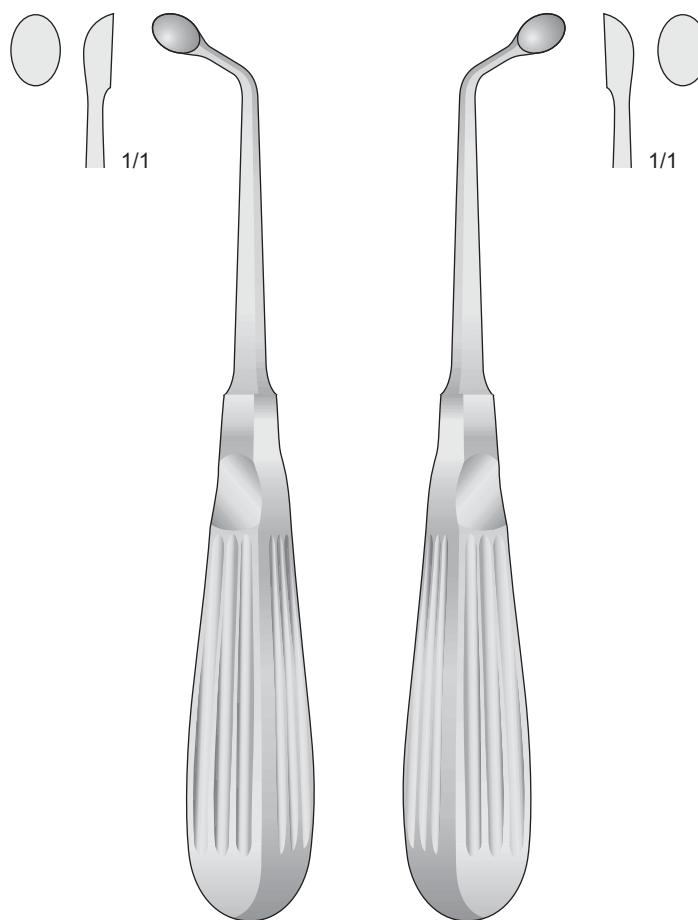

UFFENDORDE
FK-188
 170 mm

UFFENDORDE
FK-189
 170 mm

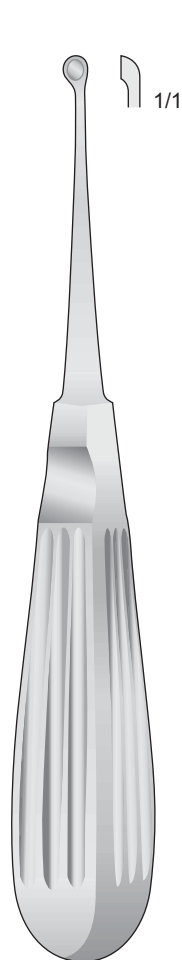

BRUNS
FK-110/FK-116
165 mm

Fig.000
3 mm



FK-110

Fig.00
4 mm



FK-111

Fig.0
5 mm



FK-112

Fig.1
6 mm



FK-113

Fig.2
8 mm



FK-114

Fig.3
10 mm



FK-115

Fig.4
12 mm



FK-116

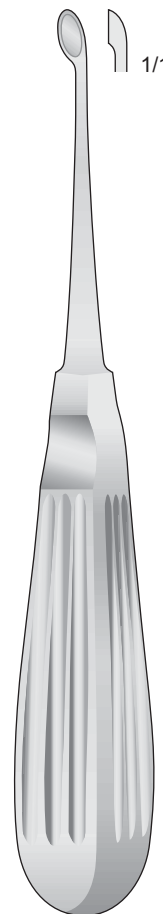

SCHEDE
FK-120/FK-126
170 mm

Fig.000
2,5 mm



FK-120

Fig.00
3,4 mm



FK-121

Fig.0
4,2 mm



FK-122

Fig.1
5,2 mm



FK-123

Fig.2
6,3 mm



FK-124

Fig.3
7,4 mm



FK-125

Fig.4
8 mm



FK-126

11

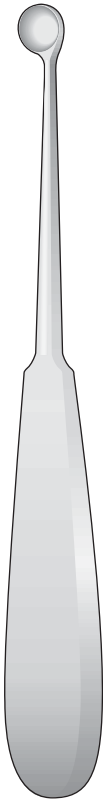

- Fig.1
○ 1/1
FK-01
- Fig.2
○ 1/1
FK-02
- Fig.3
○ 1/1
FK-03
- Fig.4
○ 1/1
FK-04
- Fig.5
○ 1/1
FK-05
- Fig.6
○ 1/1
FK-06
- Fig.7
○ 1/1
FK-07
- Fig.8
○ 1/1
FK-08

FK-01/FK-08
180 mm

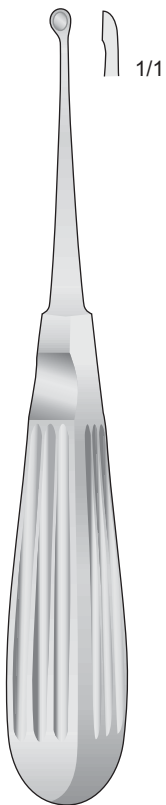

- Fig.0000
2,8 mm
○ 1/1
FK-60
- Fig.000
3,6 mm
○ 1/1
FK-61
- Fig.00
4,4 mm
○ 1/1
FK-62
- Fig.0
5,2 mm
○ 1/1
FK-63
- Fig.1
6,8 mm
○ 1/1
FK-64
- Fig.2
8,5 mm
○ 1/1
FK-65
- Fig.3
10 mm
○ 1/1
FK-66
- Fig.4
11,5 mm
○ 1/1
FK-67
- Fig.5
13 mm
○ 1/1
FK-68
- Fig.6
14,5 mm
○ 1/1
FK-69

VOLKMANN
FK-60/FK-69
170 mm



FK-31/FK-39
210 mm

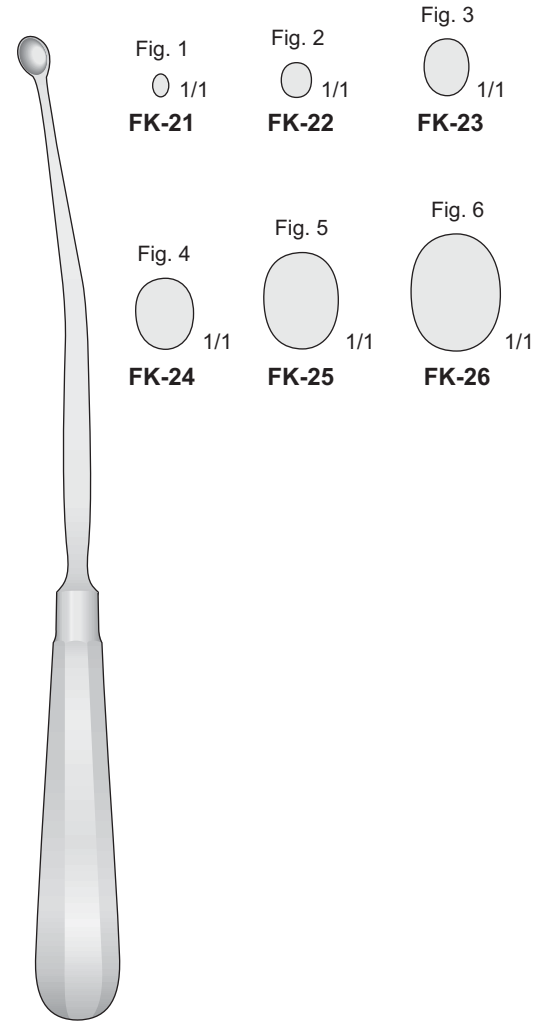
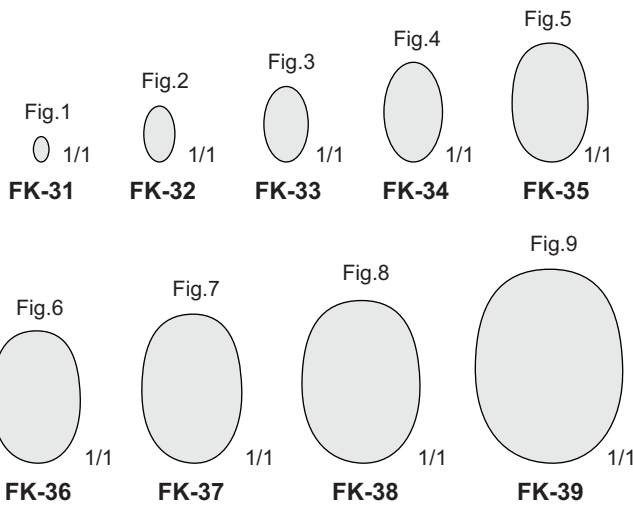

FK-21/FK-26
260 mm

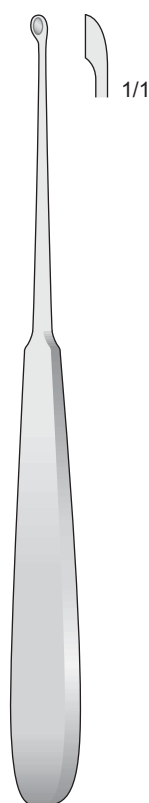

Fig. 00
3,4 mm
1/1
FK-197

Fig. 1
5,2 mm
1/1
FK-198

WILLIGER
FK-197/FK-198
170 mm

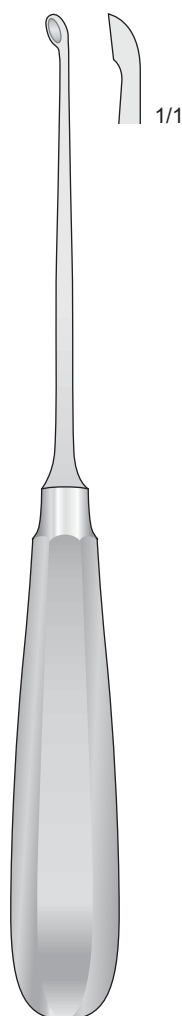
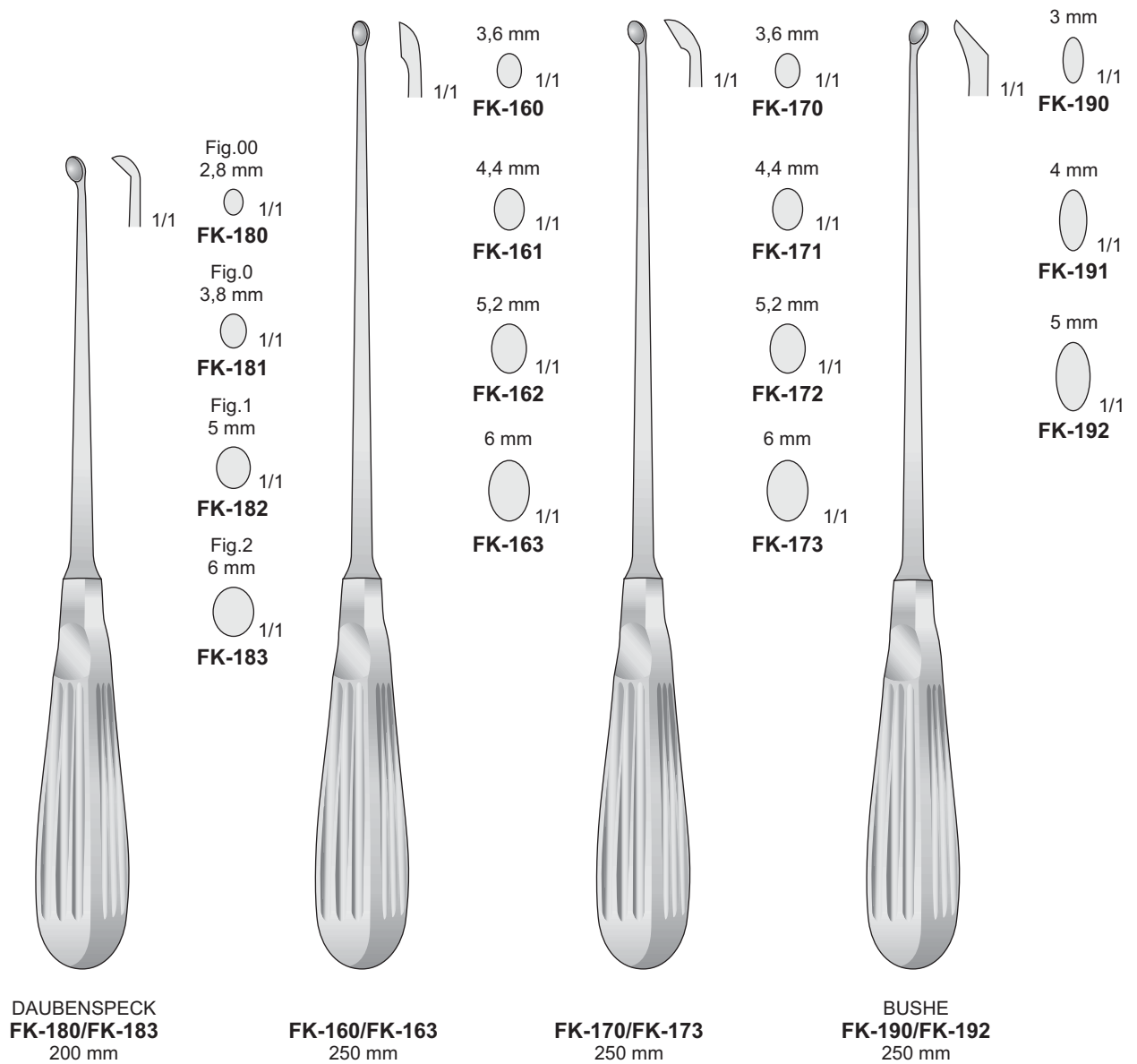

Fig.00
4,4 mm
1/1
FK-130

Fig.0
5,2 mm
1/1
FK-131

Fig.1
6,8 mm
1/1
FK-132

HALLE
FK-130/FK-132
215 mm



11

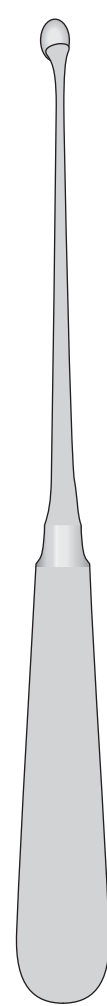
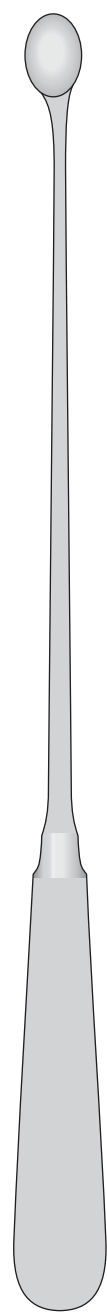

 <p>SIMON FK-147/FK-149 235 mm</p>	<p>Fig.000 3,6 mm 1/1 FK-147</p>	 <p>SIMON FK-140/FK-145 240 mm</p>	<p>Fig.1 6,8 mm 1/1 FK-140</p>	<p>Fig.2 8,5 mm 1/1 FK-141</p>	 <p>SCHRÖDER FK-150/FK-155 310 mm</p>	<p>Fig.1 6,8 mm 1/1 FK-150</p>	<p>Fig.2 8,5 mm 1/1 FK-151</p>
	<p>Fig.00 4,4 mm 1/1 FK-148</p>		<p>Fig.3 10 mm 1/1 FK-142</p>	<p>Fig.4 11,5 mm 1/1 FK-143</p>		<p>Fig.3 10 mm 1/1 FK-152</p>	<p>Fig.4 11,5 mm 1/1 FK-153</p>
	<p>Fig.0 5,2 mm 1/1 FK-149</p>		<p>Fig.5 13 mm 1/1 FK-144</p>	<p>Fig.6 14,5 mm 1/1 FK-145</p>		<p>Fig.5 13 mm 1/1 FK-154</p>	<p>Fig.6 14,5 mm 1/1 FK-155</p>

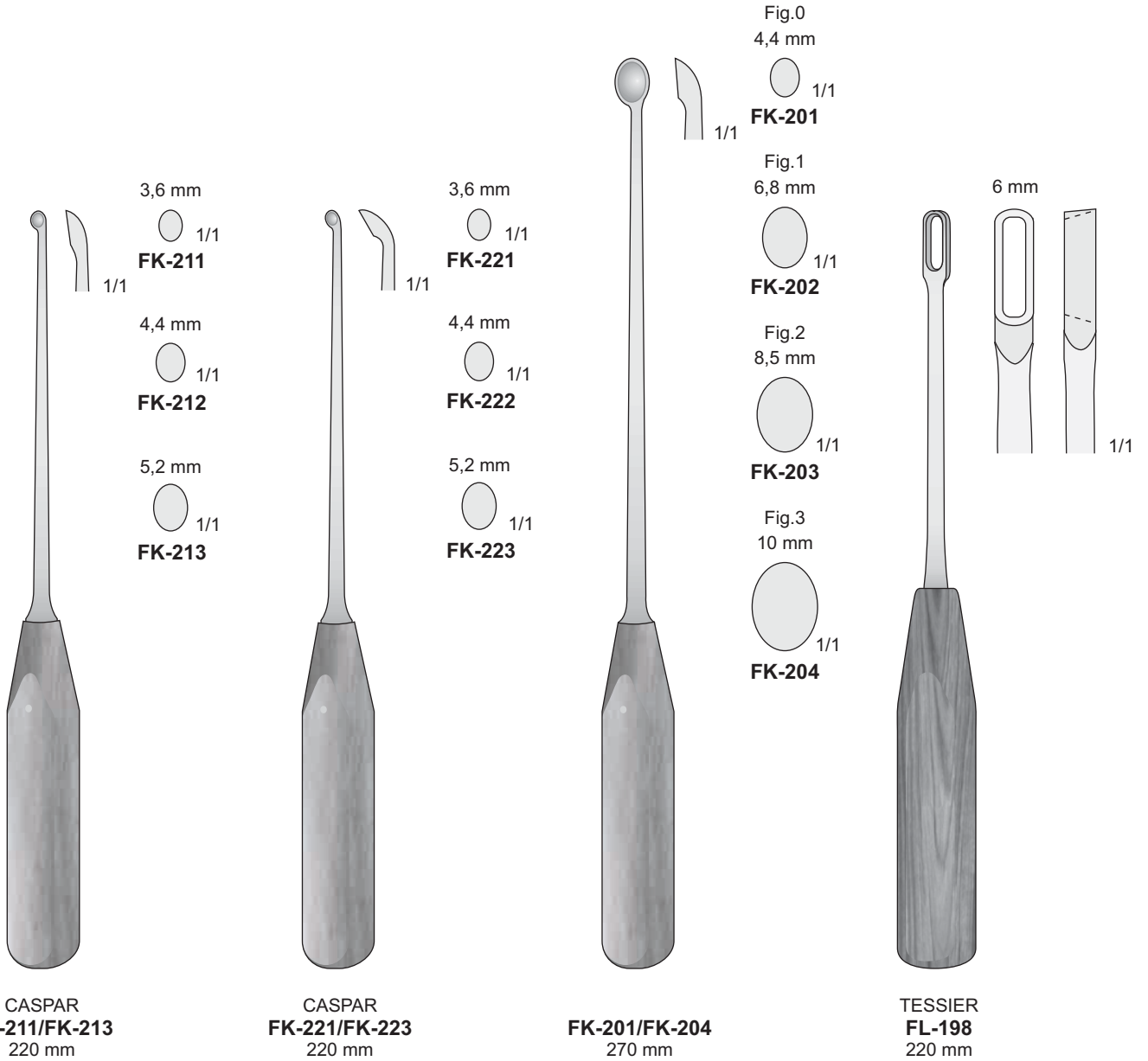

Strumentario per protesi femorale
 Femoral prosthesis instrumentation
 Instruments pour prothese femorale

Con manico Ferrozell
 With Ferrozell handle
 Mit Ferrozellgriff
 Avec poignée en Ferrozell
 Con mango de Ferrozell

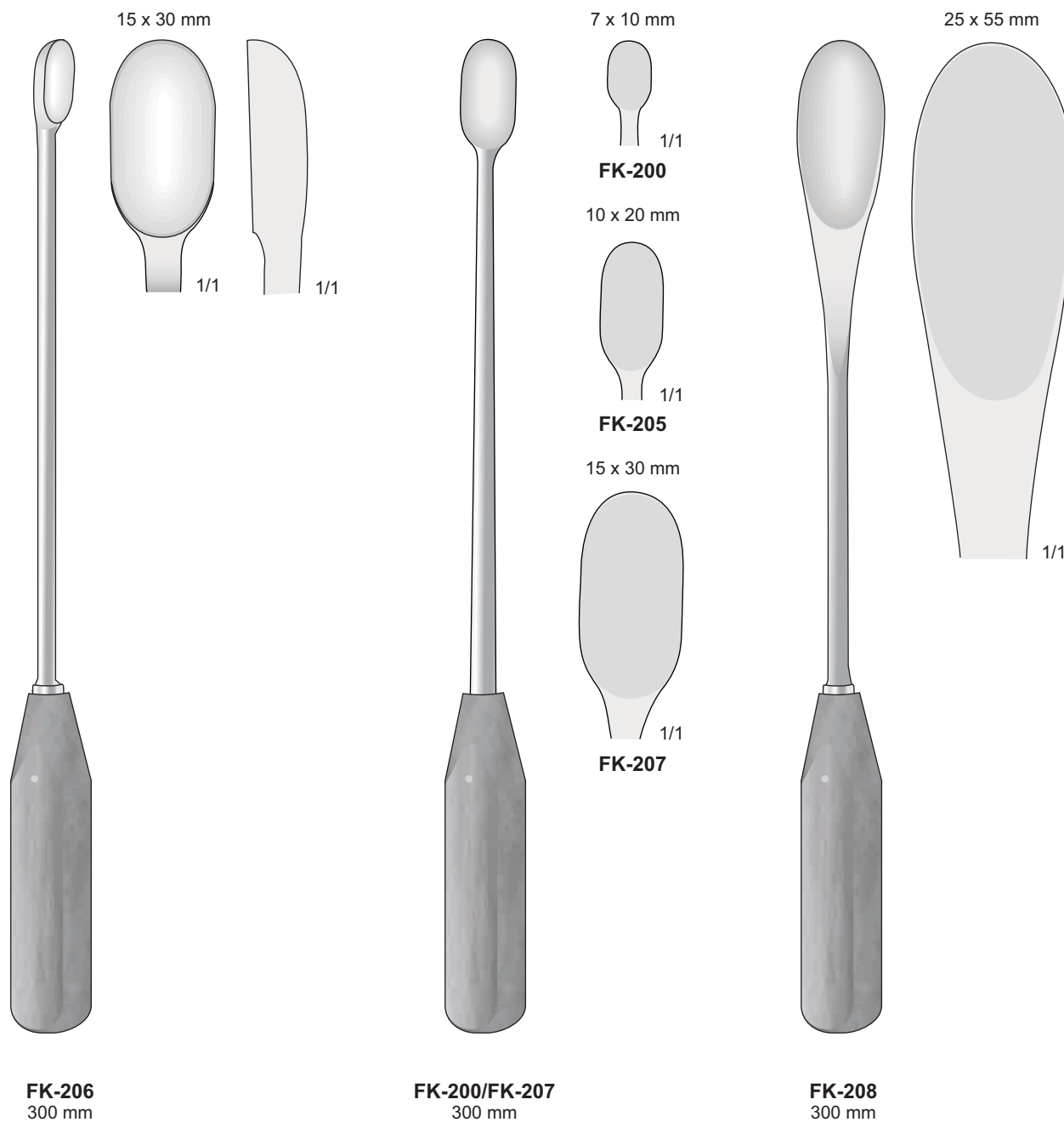

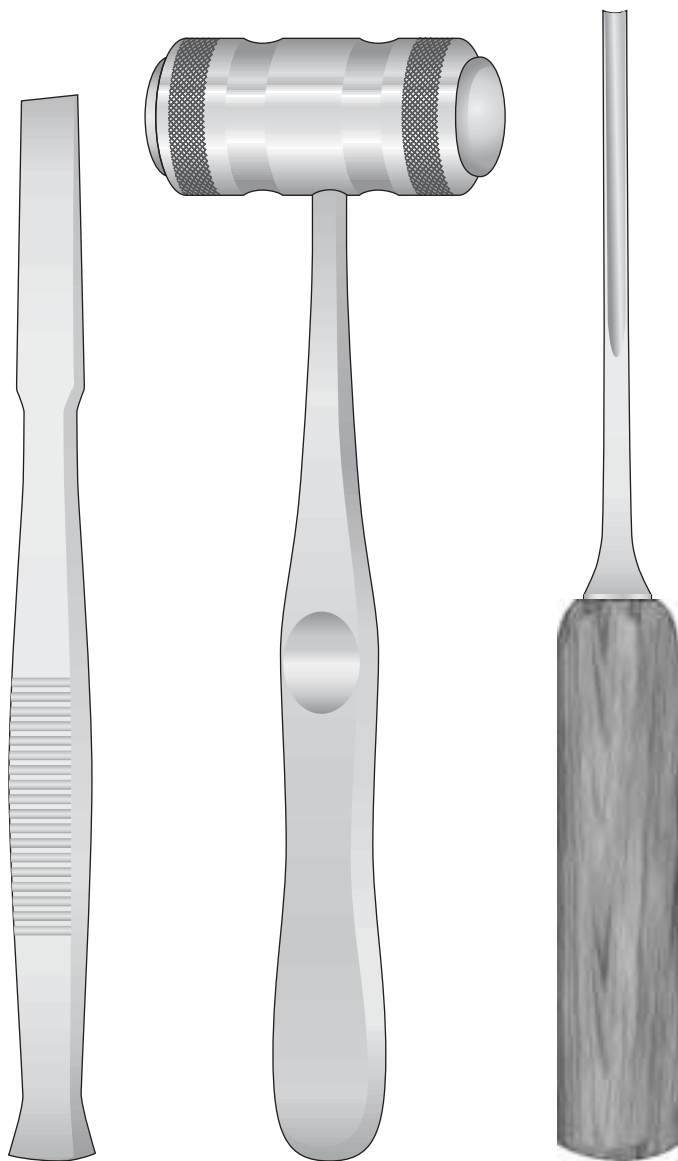

12 |

Mallet | Osteotome | Bone Chisel
Hämmer | Osteotom | Knochenmeißel
Maillet | Ostéotome | Burin à os
Martillo | Osteotomo | Cincel para hueso
Martello | Osteotomo | Scalpello per osso

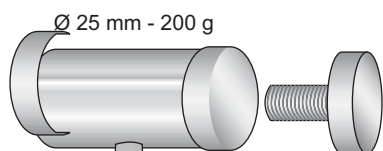
**FL-11R**

Coppia di teste di ricambio
 Pair of spare faces
 Paar Ersatzbacken
 Paire de faces de rechange
 Pareja de tapas intercambiables

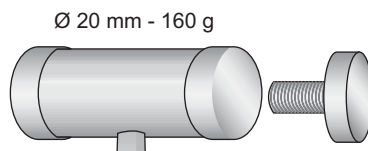

MEAD
FL-11
 200 mm

**FL-09R**

Coppia di teste di ricambio
 Pair of spare faces
 Paar Ersatzbacken
 Paire de faces de rechange
 Pareja de tapas intercambiables

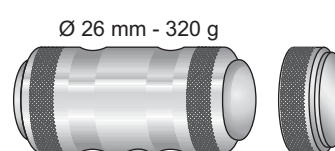

MEAD
FL-09
 190 mm

**FL-12R**

Coppia di teste di ricambio
 Pair of spare faces
 Paar Ersatzbacken
 Paire de faces de rechange
 Pareja de tapas intercambiables



MEAD
FL-12
 190 mm
 Ø 20 mm - 240 g

Ø 20 mm - 140 g



FL-01
 165 mm

Ø 25 mm - 300 g

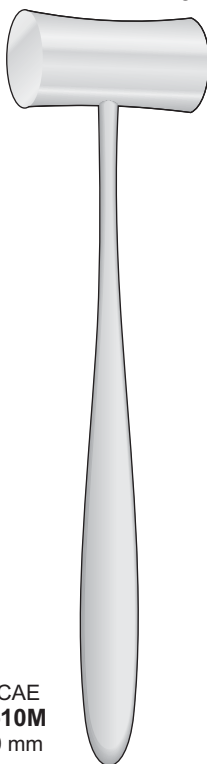

LUCAE
FL-10M
 190 mm

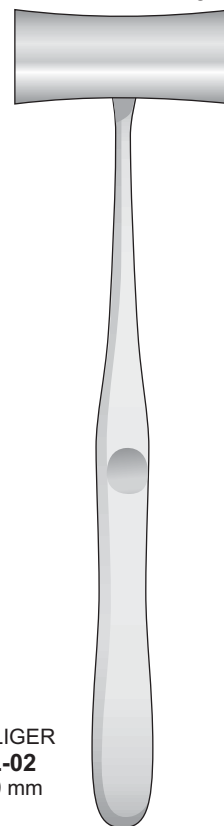

WILLIGER
FL-02
 240 mm

1 Lato piatto - 1 Lato convesso
1 Side flat - 1 Side convex
1 Seite flach - 1 Seite convex
1 Face plate - 1 Face convexe
1 Parte plana - 1 Parte convexa

Ø 30 mm - 240 g

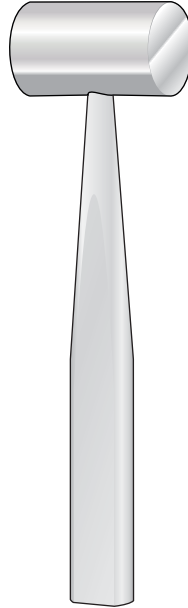

COTTLE
FL-104
185 mm

Ø 30 mm - 300 g

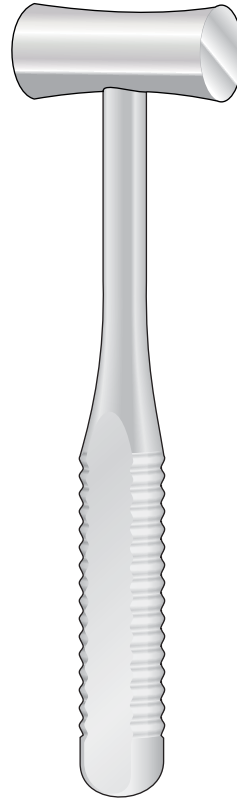

BERGMANN
FL-105
235 mm

Ø 45 mm - 300 g

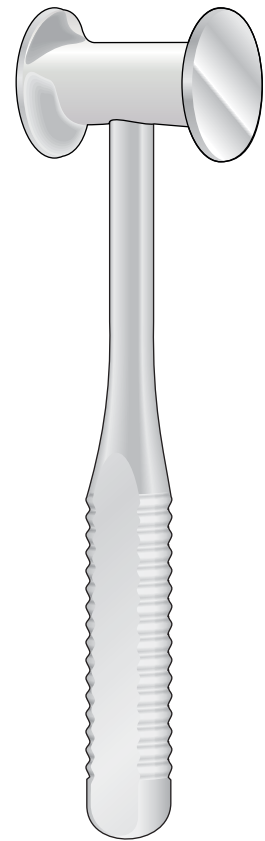

BERGMANN
FL-106
245 mm

Ø 30 mm

400 g

Ø 42 mm

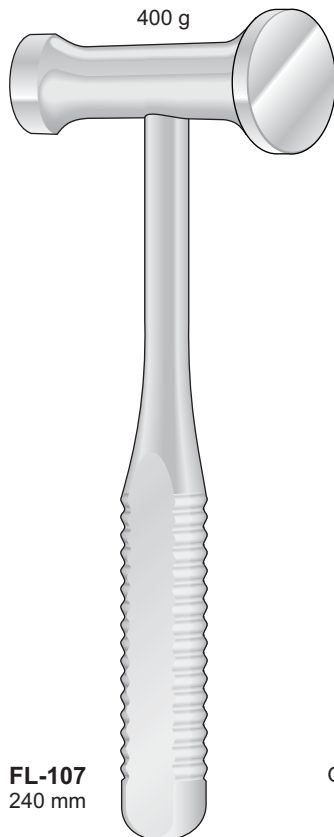

FL-107
240 mm

Ø 40 mm - 550 g

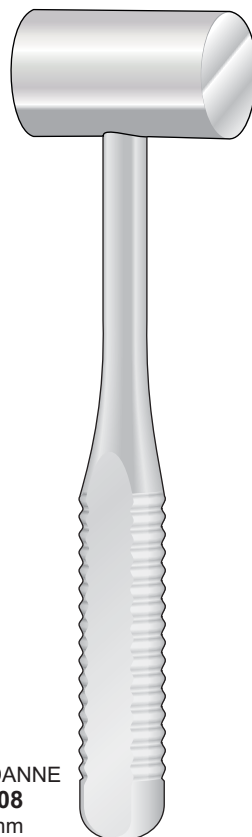

OMBREDANNE
FL-108
240 mm

Ø 40 mm - 700 g

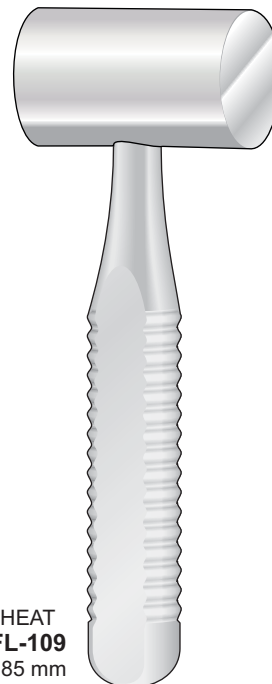

HEAT
FL-109
185 mm

Ø 40 mm - 900 g

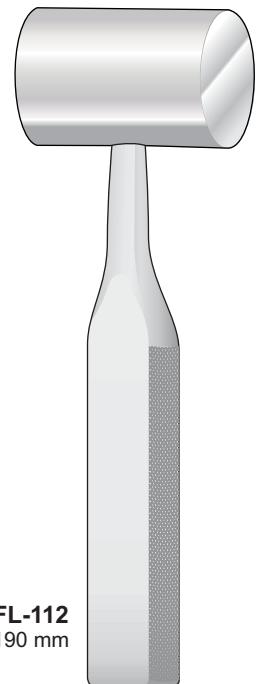

FL-112
190 mm

12

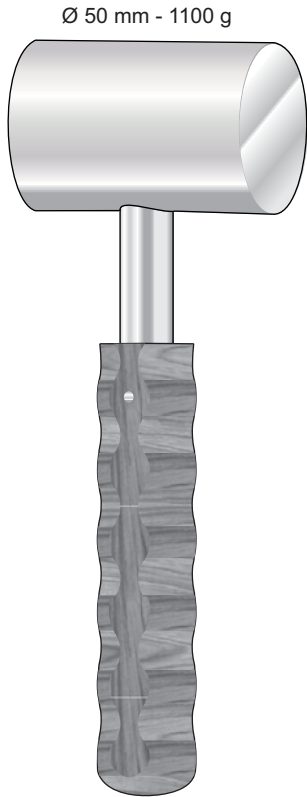

Ø 50 mm - 1100 g

FL-111
200 mm

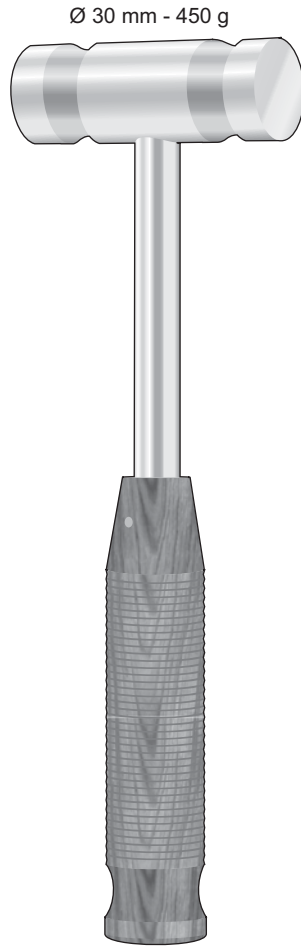

Ø 30 mm - 450 g

FL-06
260 mm



Ø 50 mm - 1450 g

FL-113
270 mm



CASPAR
FF-147/FF-149
200 mm

-  **FF-147**
Ø3 mm
-  **FF-148**
Ø5 mm
-  **FF-149**
Ø8 mm







FL-253/FL-255
200 mm

-  **FL-253**
Ø12 mm
-  **FL-254**
Ø14 mm
-  **FL-255**
Ø16 mm



SYPERT
FL-256/FL-259
290 mm

-  **FL-256**
3x8 mm
-  **FL-257**
4x10 mm
-  **FL-258**
5x15 mm
-  **FL-259**
6x20 mm

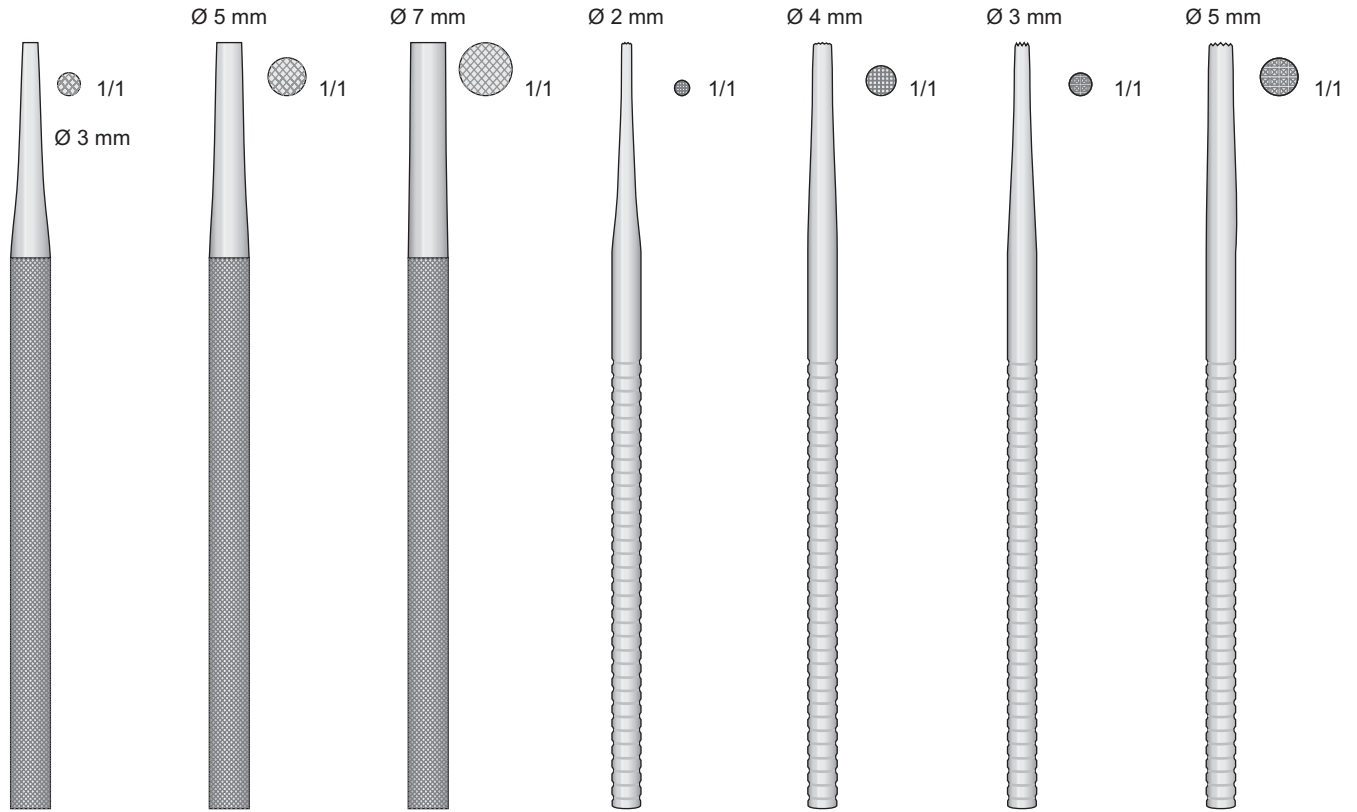

FL-20
155 mm

FL-21
155 mm

FL-22
155 mm

FL-30
155 mm

FL-31
155 mm

FL-33
155 mm

FL-35
155 mm

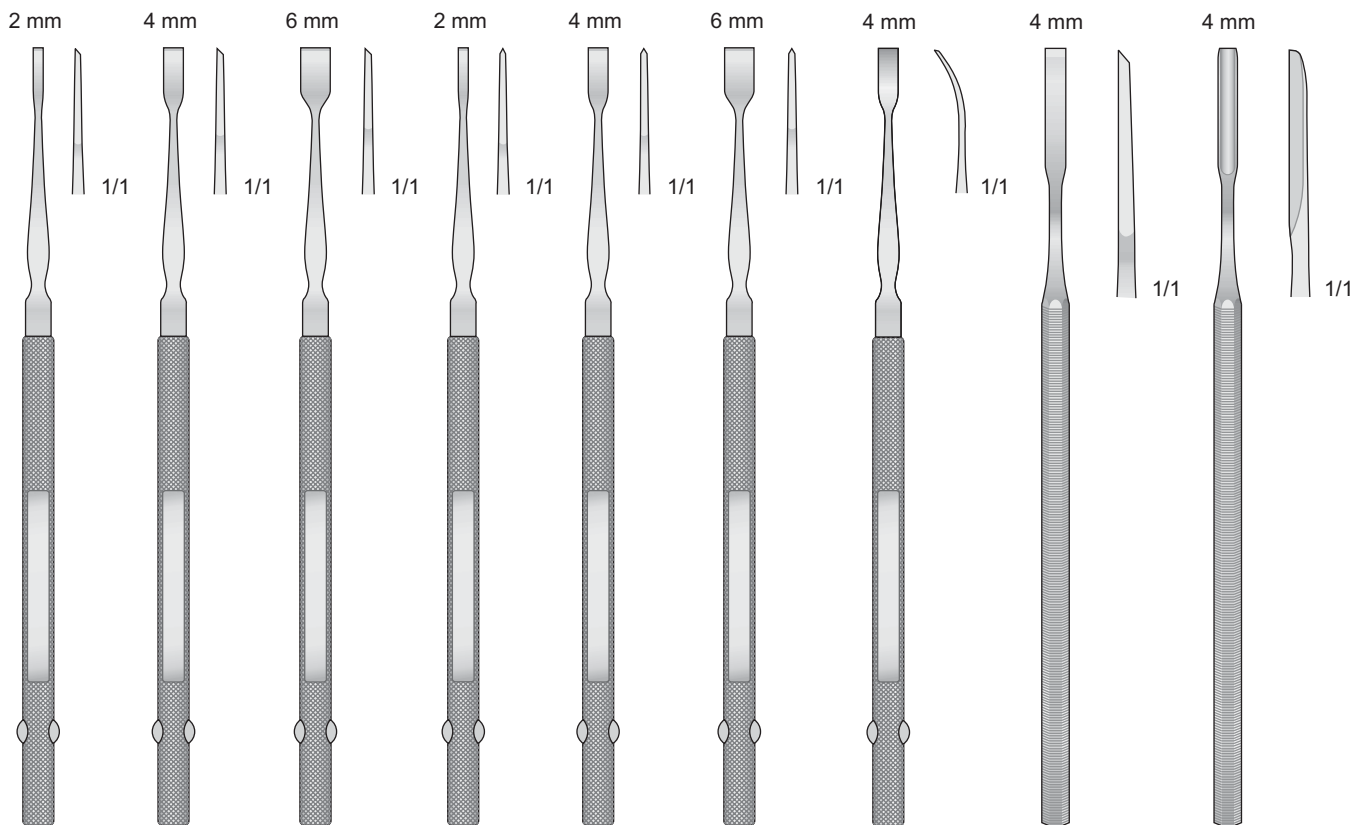

TG-10
160 mm

TG-11
160 mm

TG-12
160 mm

TG-20
160 mm

TG-21
160 mm

TG-22
160 mm

FREER
TG-23
160 mm

BUCKLEY
TG-40
160 mm

BUCKLEY
TG-41
160 mm

Osteotomi -Osteotomes
Osteotome - Ostéotomes - Osteótomos

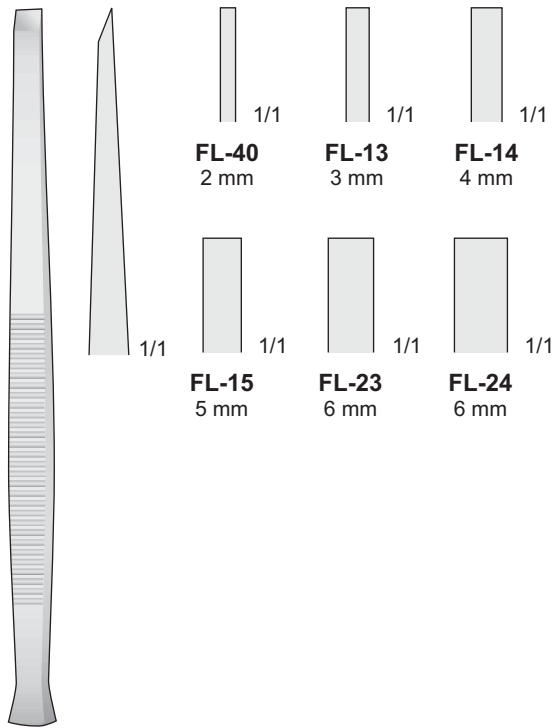

PARTSCH
FL-13/FL-40
140 mm

Sgorbie - Gouges
Hohlmeissel - Gouges - Gubias

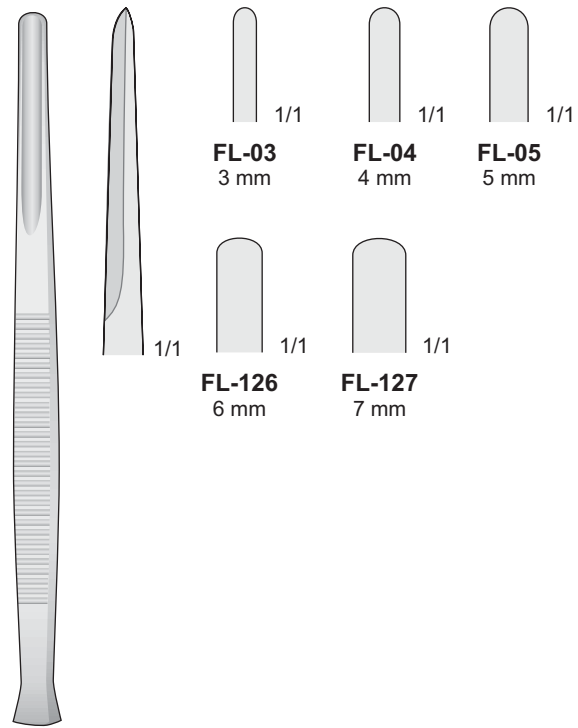

PARTSCH
FL-03/FL-127
140 mm

Osteotomi -Osteotomes
Osteotome - Ostéotomes - Osteótomos

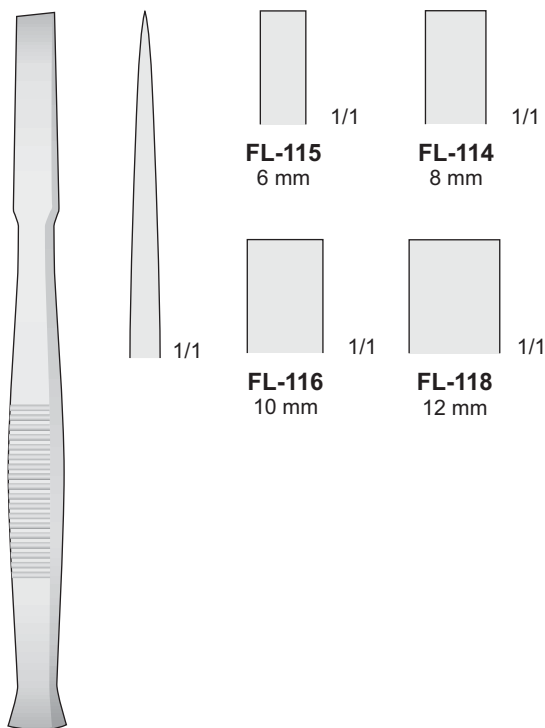

FL-114/FL-118
140 mm

Sgorbie - Gouges
Hohlmeissel - Gouges - Gubias

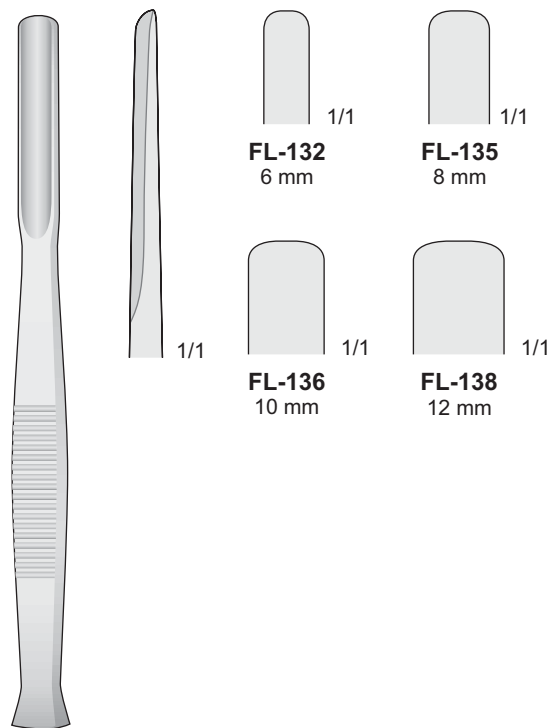

FL-132/FL-138
140 mm

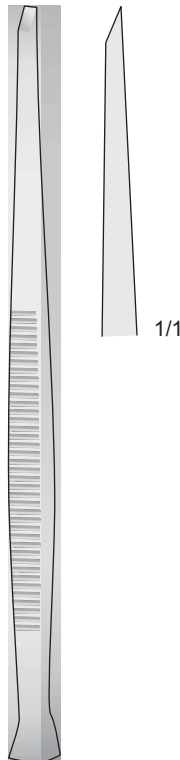
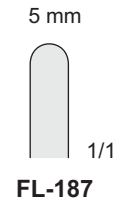
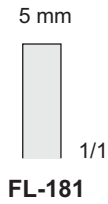
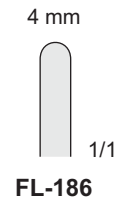
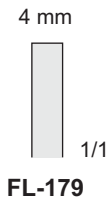
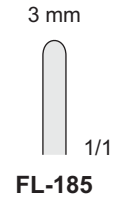
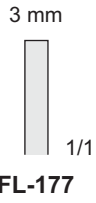

PARTSCH
FL-177/FL-184
170 mm

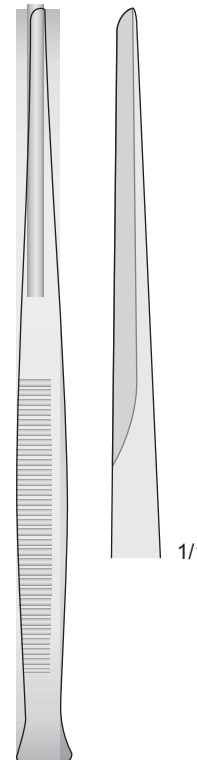
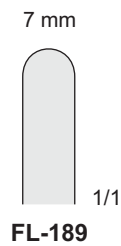
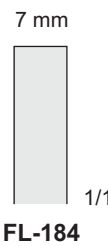
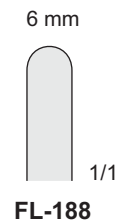
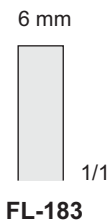

PARTSCH
FL-185/FL-189
170 mm

12

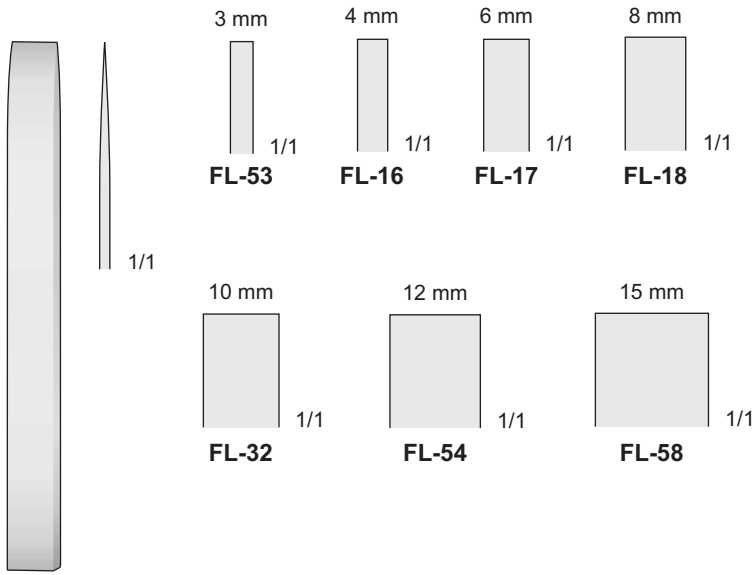

MINI-LAMBOTTE
FL-16/FL-58
125 mm



LAMBOTTE
FL-41/FL-49
250 mm

LAMBOTTE
FL-94/FL-99
250 mm

OBWEGESER
DO-18
235 mm

- FL-41 4 mm
- FL-29 8 mm
- FL-42 10 mm
- FL-34 13 mm
- FL-43 15 mm
- FL-36 18 mm
- FL-44 20 mm
- FL-45 25 mm
- FL-46 30 mm
- FL-47 38 mm
- FL-48 44 mm
- FL-49 50 mm

- FL-94 8 mm
- FL-95 13 mm
- FL-96 18 mm
- FL-97 25 mm
- FL-98 30 mm
- FL-99 38 mm

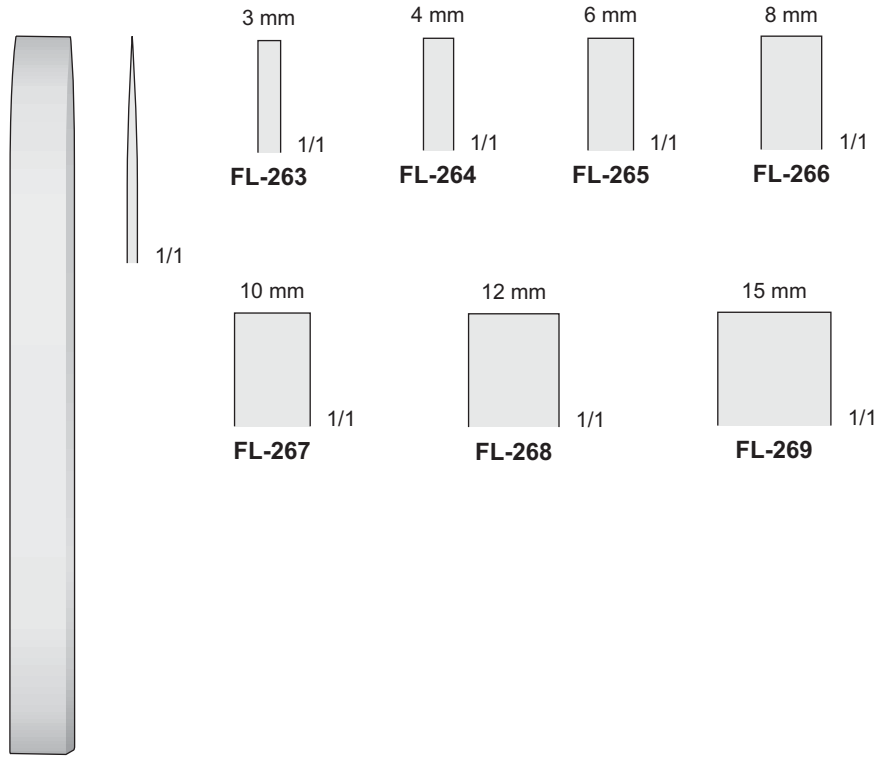

MINI-LAMBOTTE
FL-263/FL-269
170 mm

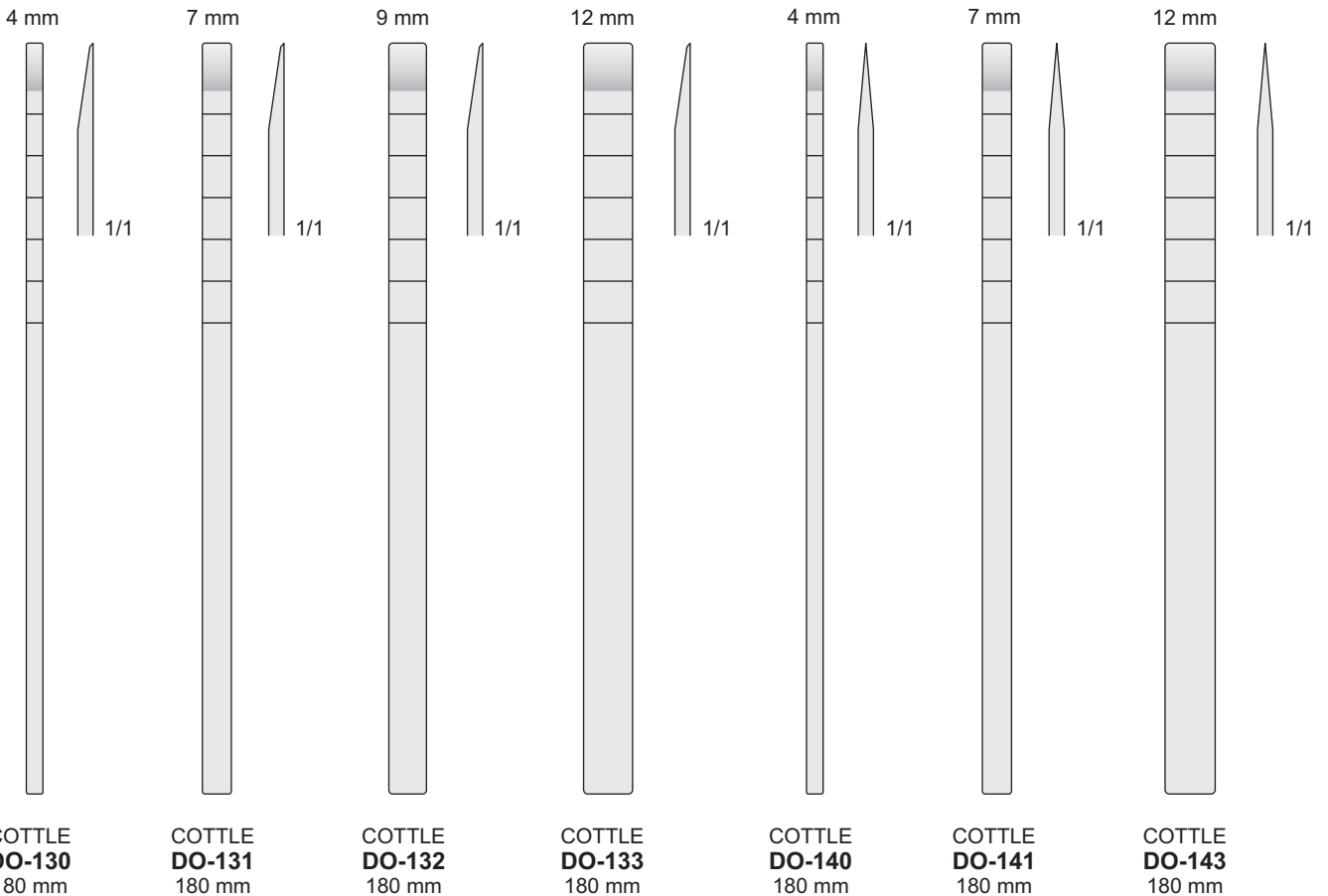

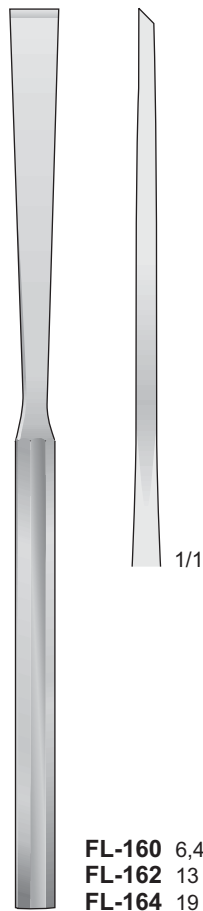

FL-160 6,4 mm
FL-162 13 mm
FL-164 19 mm

HIBBS
FL-160/FL-164
 230 mm

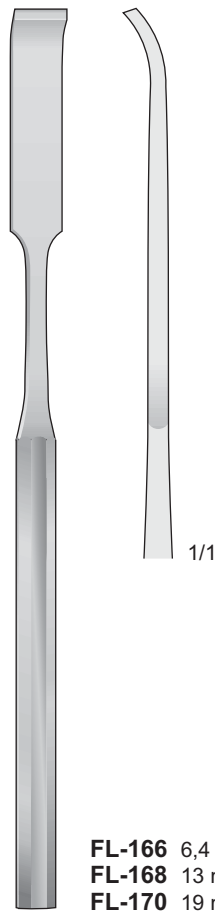

FL-166 6,4 mm
FL-168 13 mm
FL-170 19 mm

HIBBS
FL-166/FL-170
 230 mm

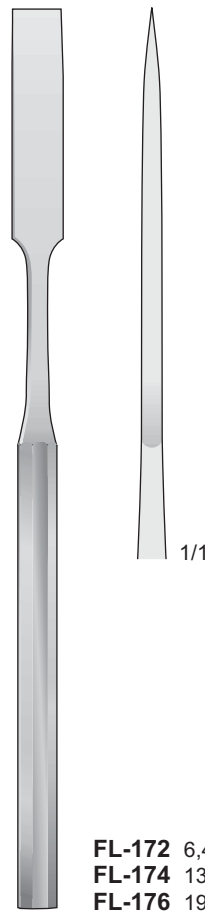

FL-172 6,4 mm
FL-174 13 mm
FL-176 19 mm

HIBBS
FL-172/FL-176
 230 mm

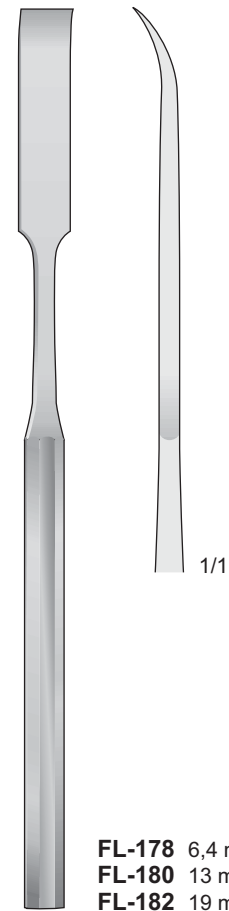

FL-178 6,4 mm
FL-180 13 mm
FL-182 19 mm

HIBBS
FL-178/FL-182
 230 mm



DO-190 4 mm
DO-191 6 mm
DO-192 8 mm

DO-190/DO-192
180 mm



DO-193 4 mm
DO-194 6 mm
DO-195 8 mm

DO-193/DO-195
180 mm



DO-196 6 mm
DO-197 8 mm

DO-196/DO-197
180 mm

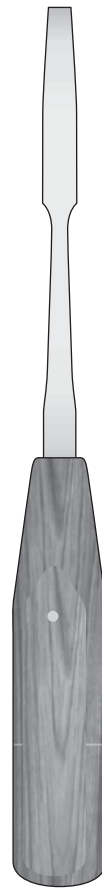

MINI-LEXER
FL-59/FL-62
200 mm

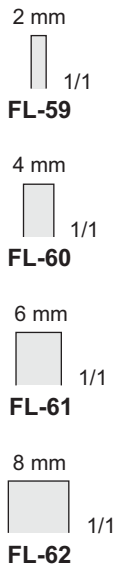

12

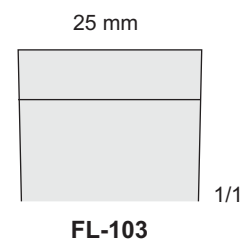
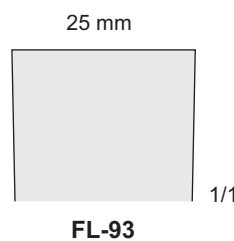
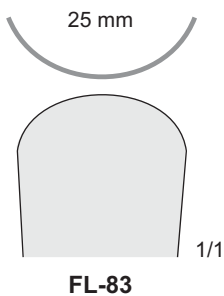
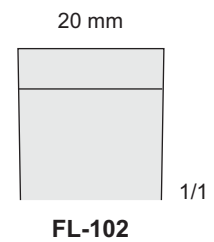
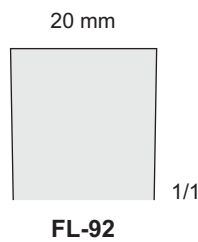
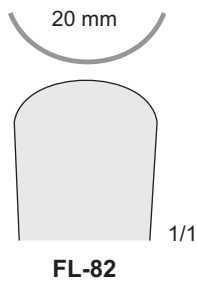
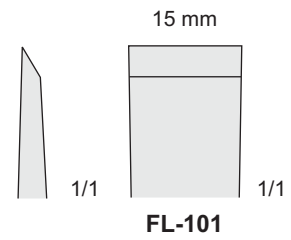
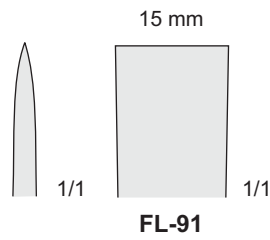
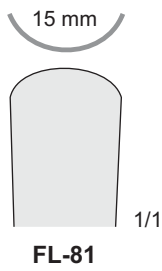
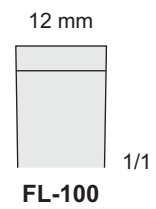
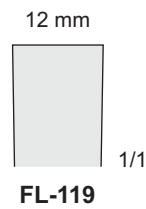
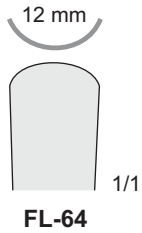
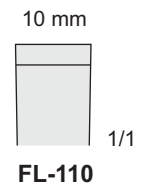
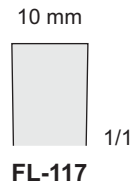
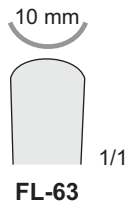

STILLE
FL-63/FL-83
200 mm

STILLE
FL-91/FL-119
200 mm

STILLE
FL-100/FL-110
200 mm

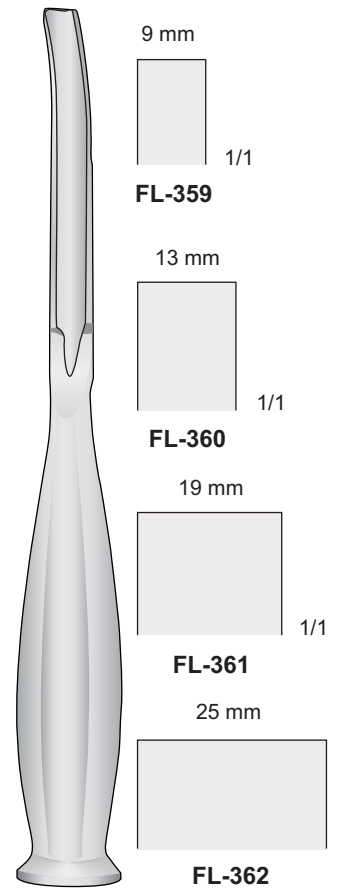
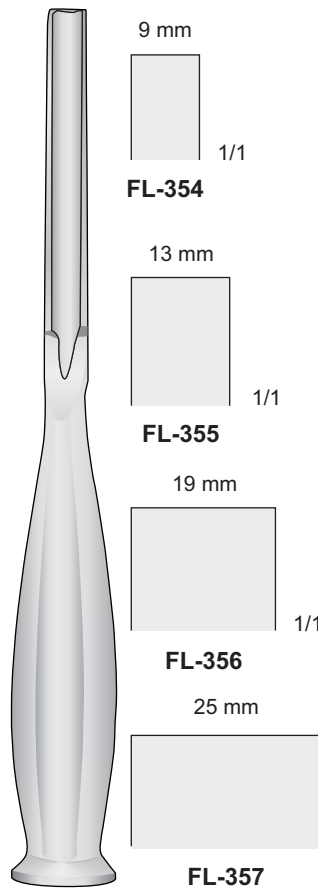
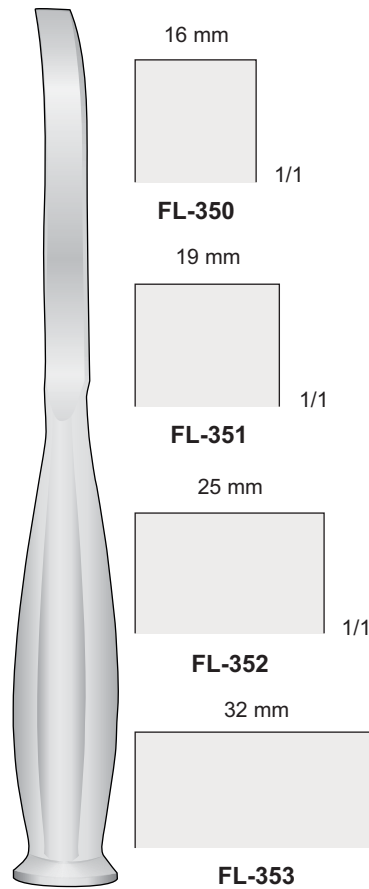
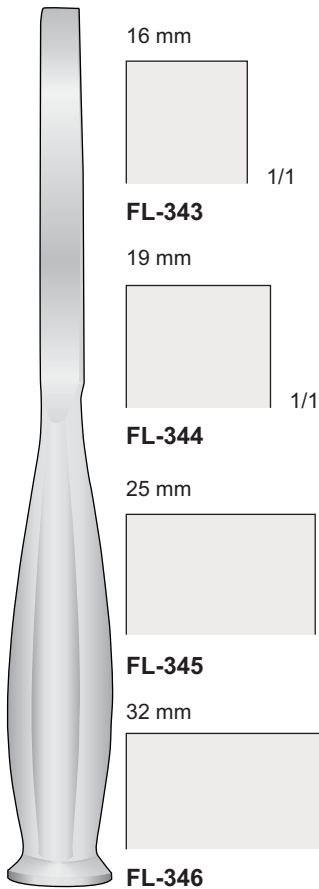
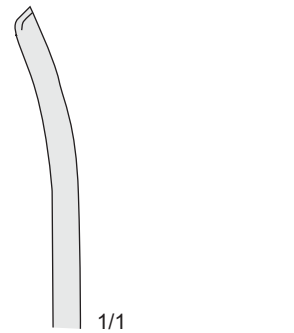
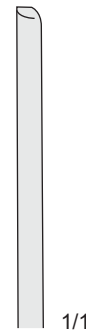
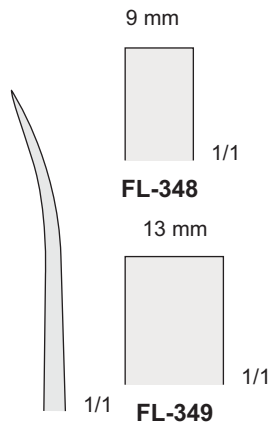
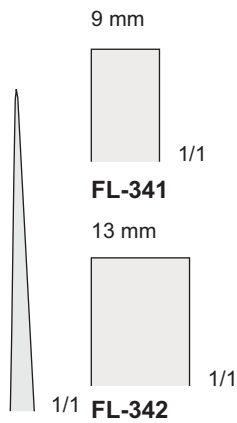
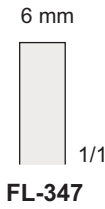
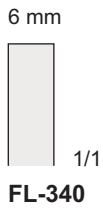

SMITH-PETERSEN
FL-340/FL-346
200 mm

SMITH-PETERSEN
FL-347/FL-353
200 mm

SMITH-PETERSEN
FL-354/FL-357
200 mm

SMITH-PETERSEN
FL-359/FL-362
200 mm

12

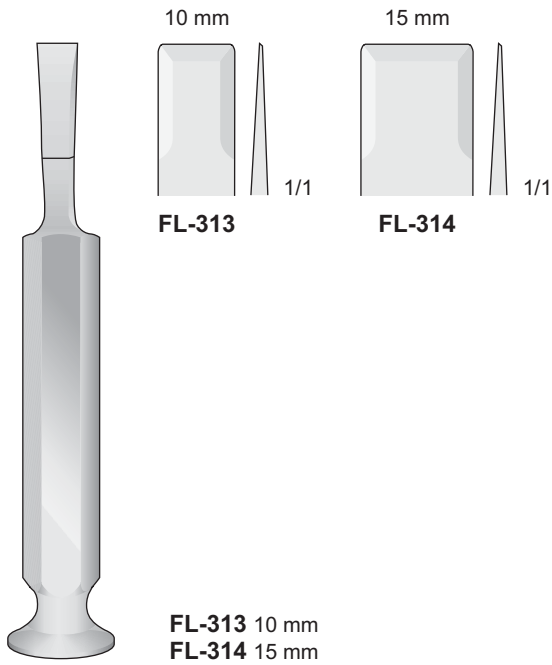

TESSIER
FL-313/FL-314
160 mm

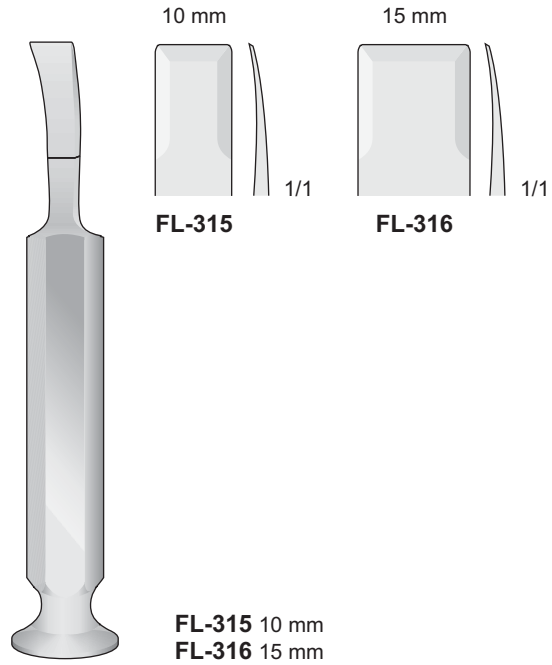

TESSIER
FL-315/FL-316
160 mm

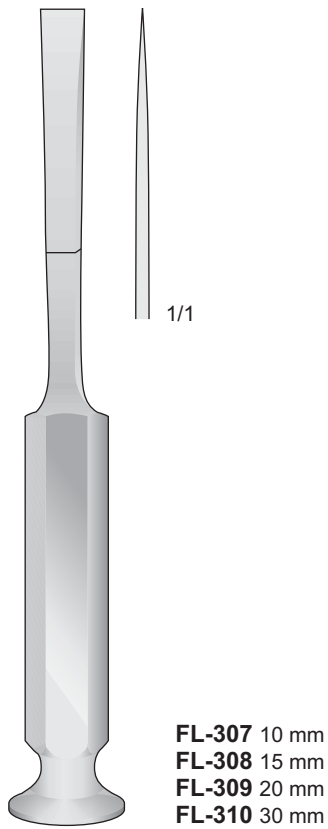

TESSIER
FL-307/FL-310
200 mm

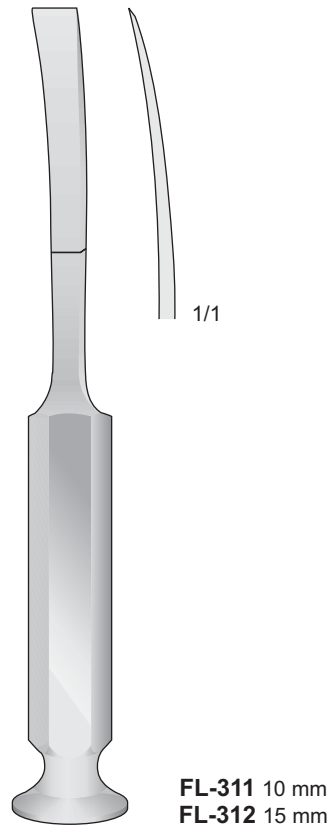

TESSIER
FL-311/FL-312
200 mm

FL-90

Set completo di
Set complete with
Komplettset mit
Set complet avec
Set completo con

1 Manico portalame in ferrozell	4 Lame Fig. 1-2-3-4	1 Chiave ferma lama
1 With Ferrozell handle	4 Blades Fig. 1-2-3-4	-
1 Mit Ferrozellgriff	4 Klingen Fig. 1-2-3-4	-
1 Avec poignée en Ferrozell	4 Lames Fig. 1-2-3-4	-
1 Con mango de Ferrozell	4 Hojas Fig. 1-2-3-4	-

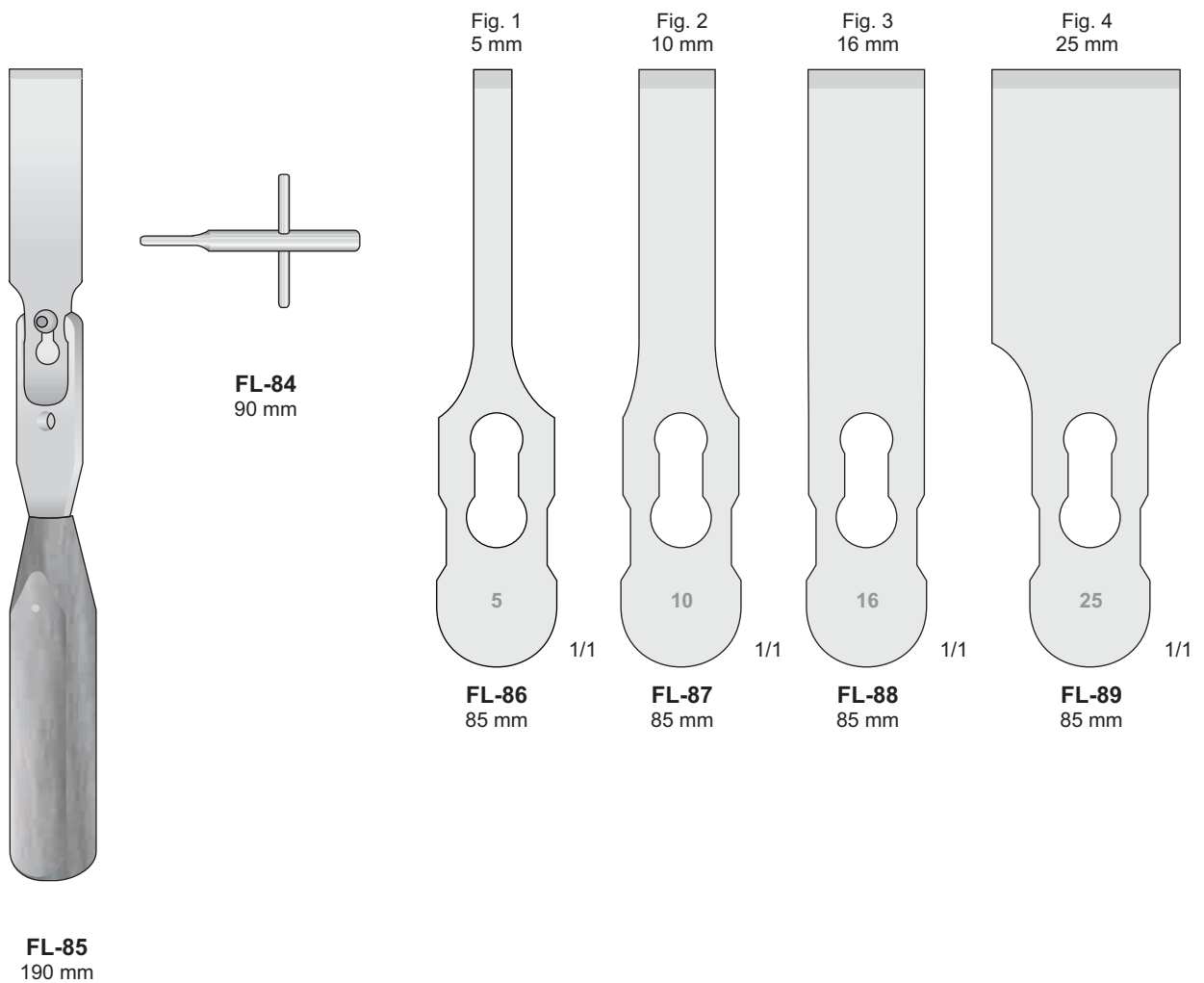

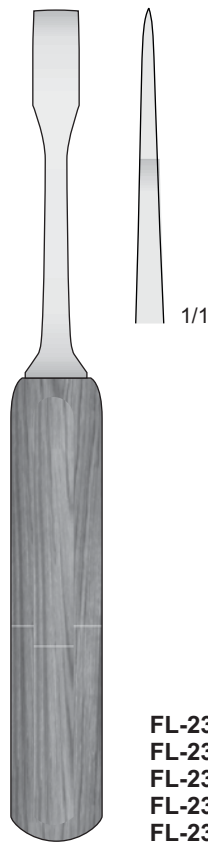

- FL-230** 4 mm
- FL-231** 6 mm
- FL-232** 8 mm
- FL-233** 10 mm
- FL-234** 12 mm

MINI-LEXER
FL-230/FL-234
180 mm

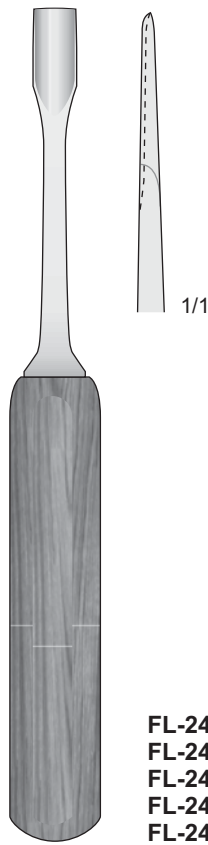

- FL-240** 4 mm
- FL-241** 6 mm
- FL-242** 8 mm
- FL-243** 10 mm
- FL-244** 12 mm

MINI-LEXER
FL-240/FL-244
180 mm

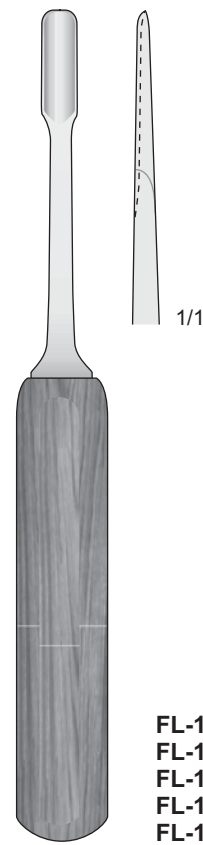

- FL-190** 4 mm
- FL-191** 6 mm
- FL-192** 8 mm
- FL-193** 10 mm
- FL-194** 12 mm

LEXER
FL-190/FL-194
180 mm

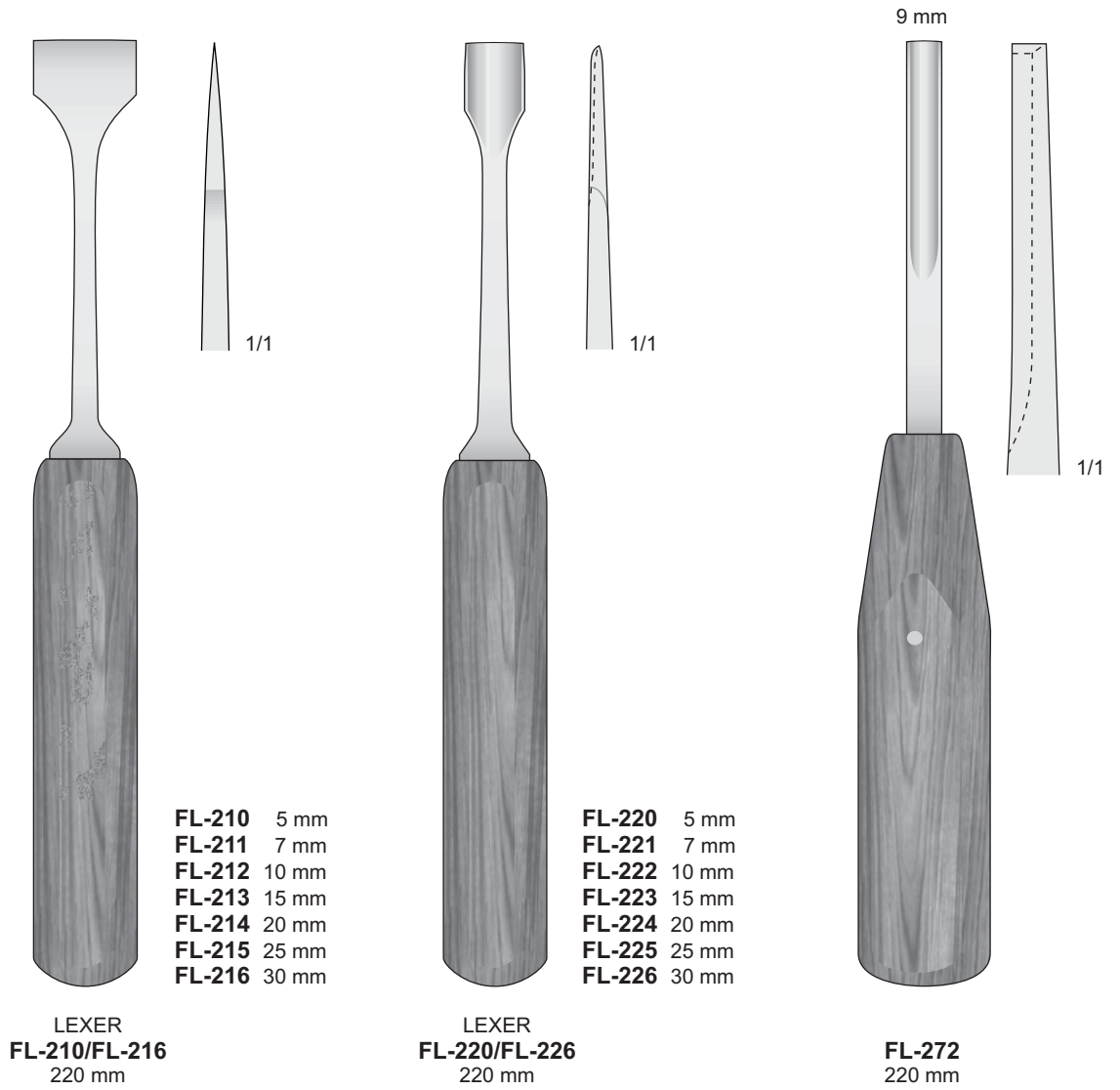

12

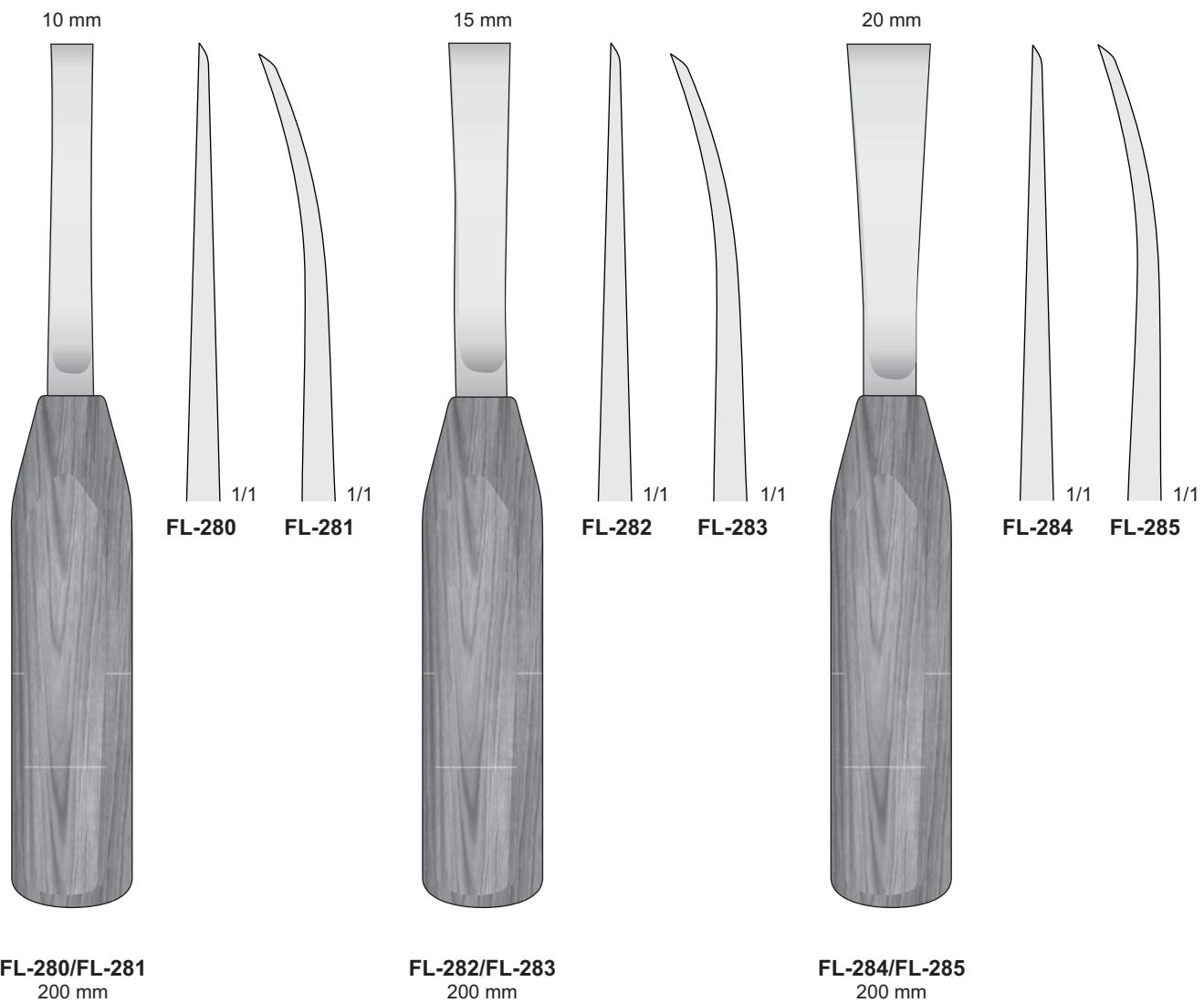

Sgorbie - Gouges
Hohlmeissel - Gouges - Gubias

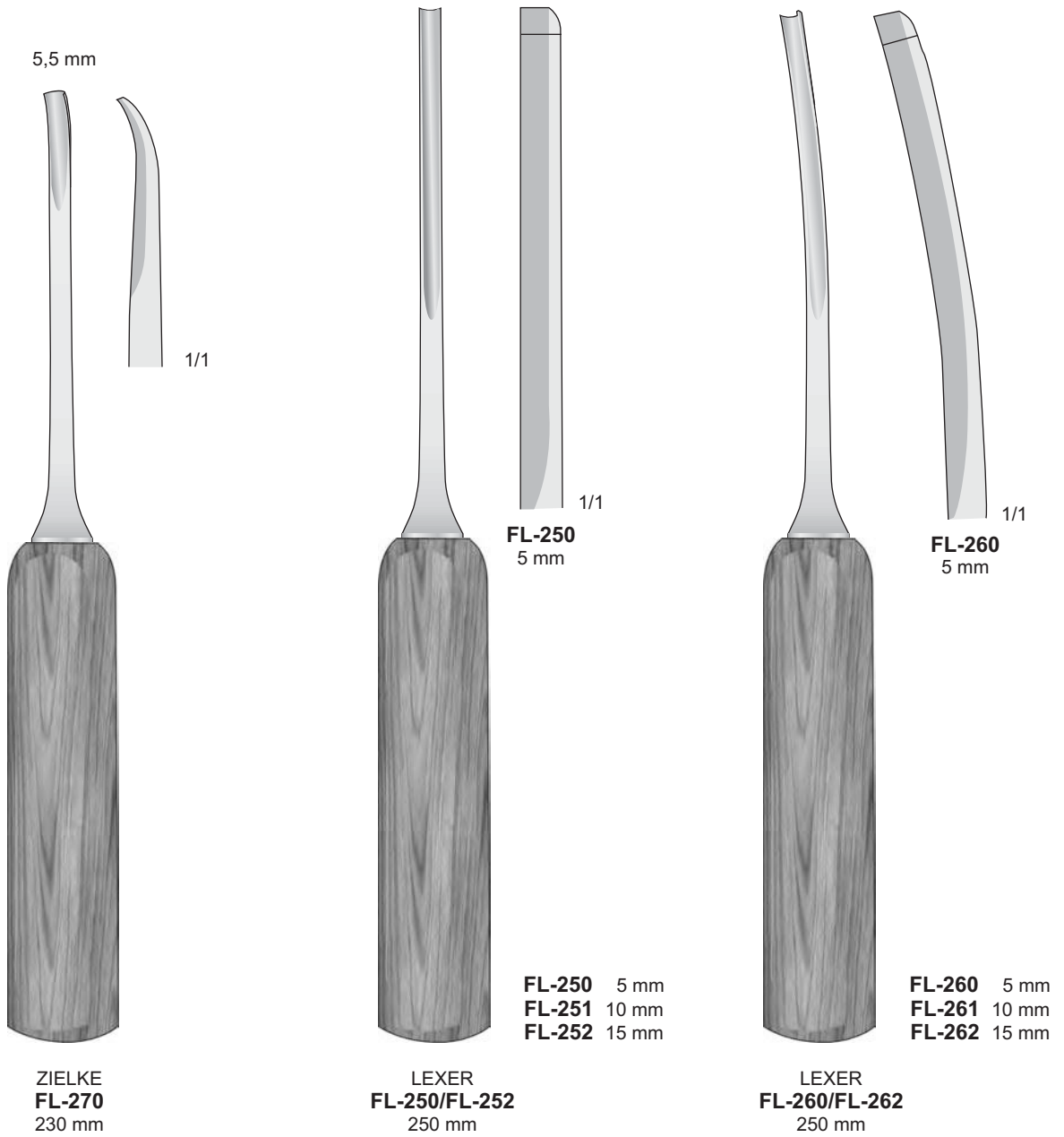

12

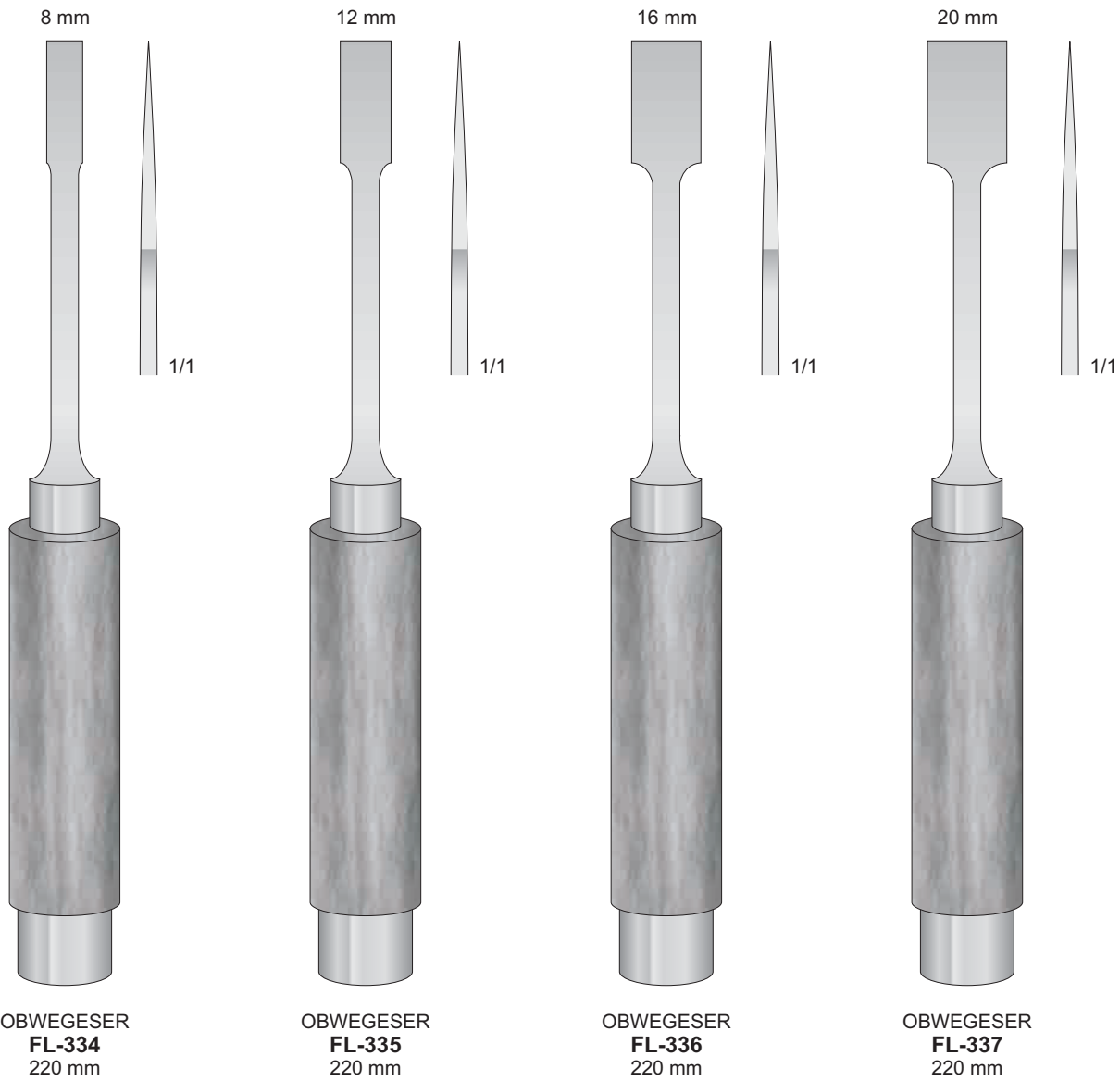

OBWEGESER
FL-334
220 mm

OBWEGESER
FL-335
220 mm

OBWEGESER
FL-336
220 mm

OBWEGESER
FL-337
220 mm

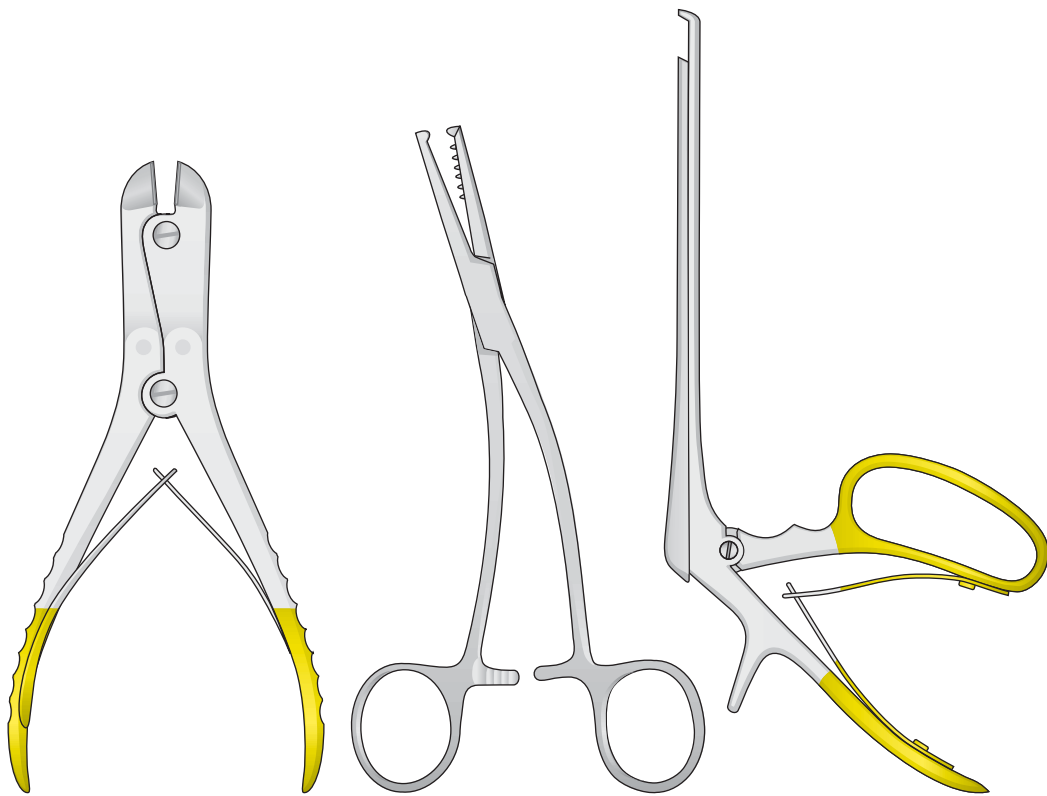

13 |

Bone surgery | Laminectomy
Knochenchirurgie | Laminektomie
Chirurgie osseuse | Laminectomia
Cirugia ósea | Laminectomía
Chirurgia ossea | Laminectomia

13

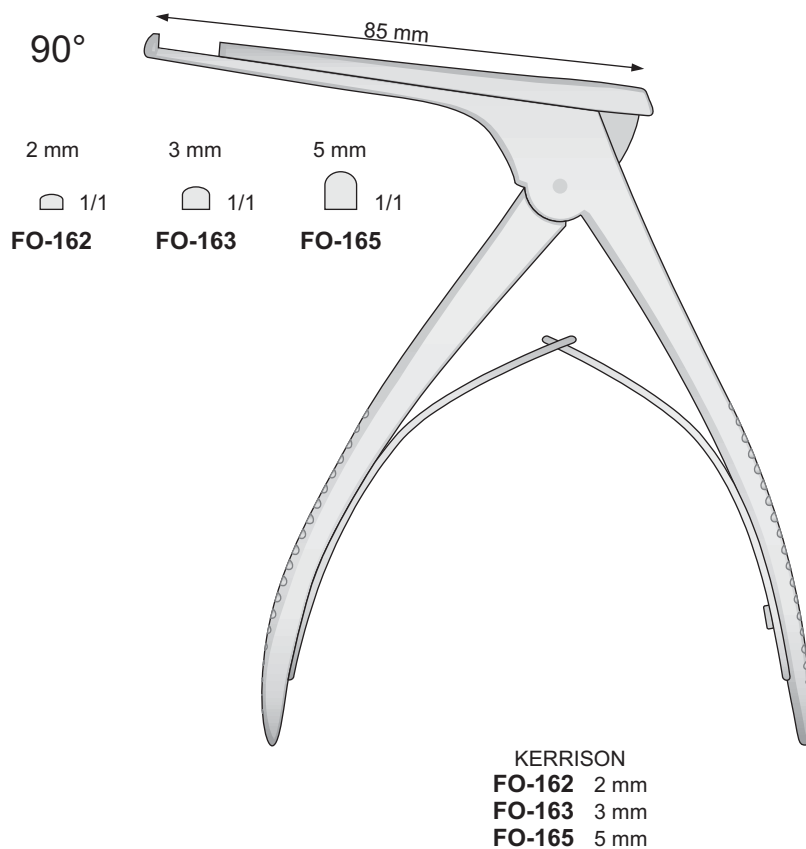
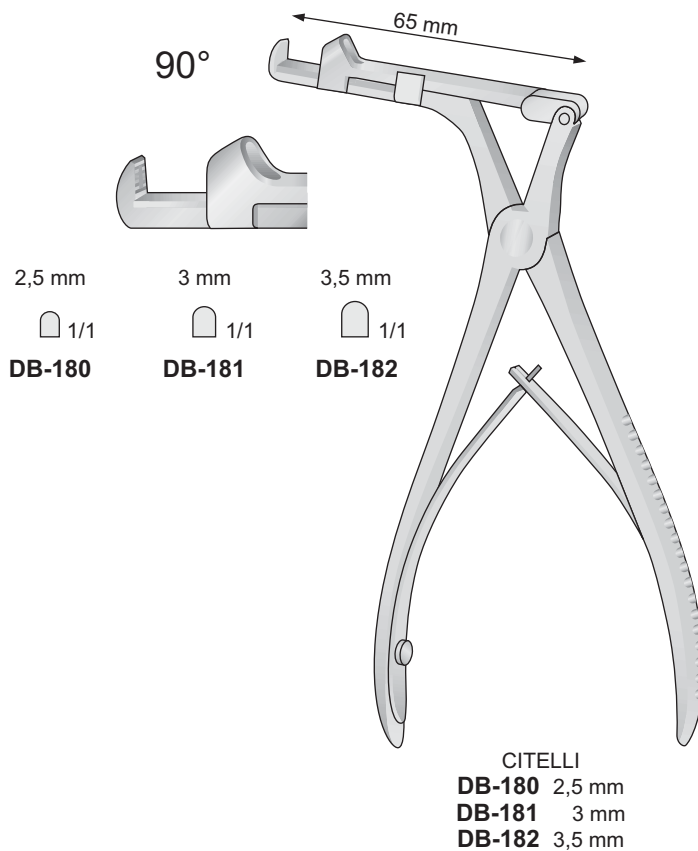

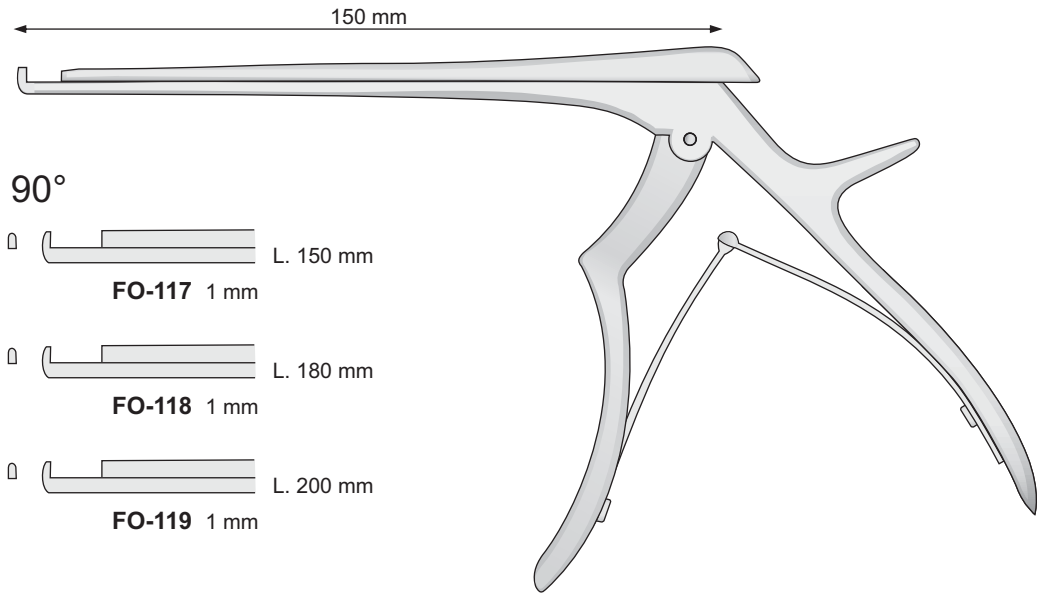

FERRIS-SMITH-KERRISON
FO-117/FO-119

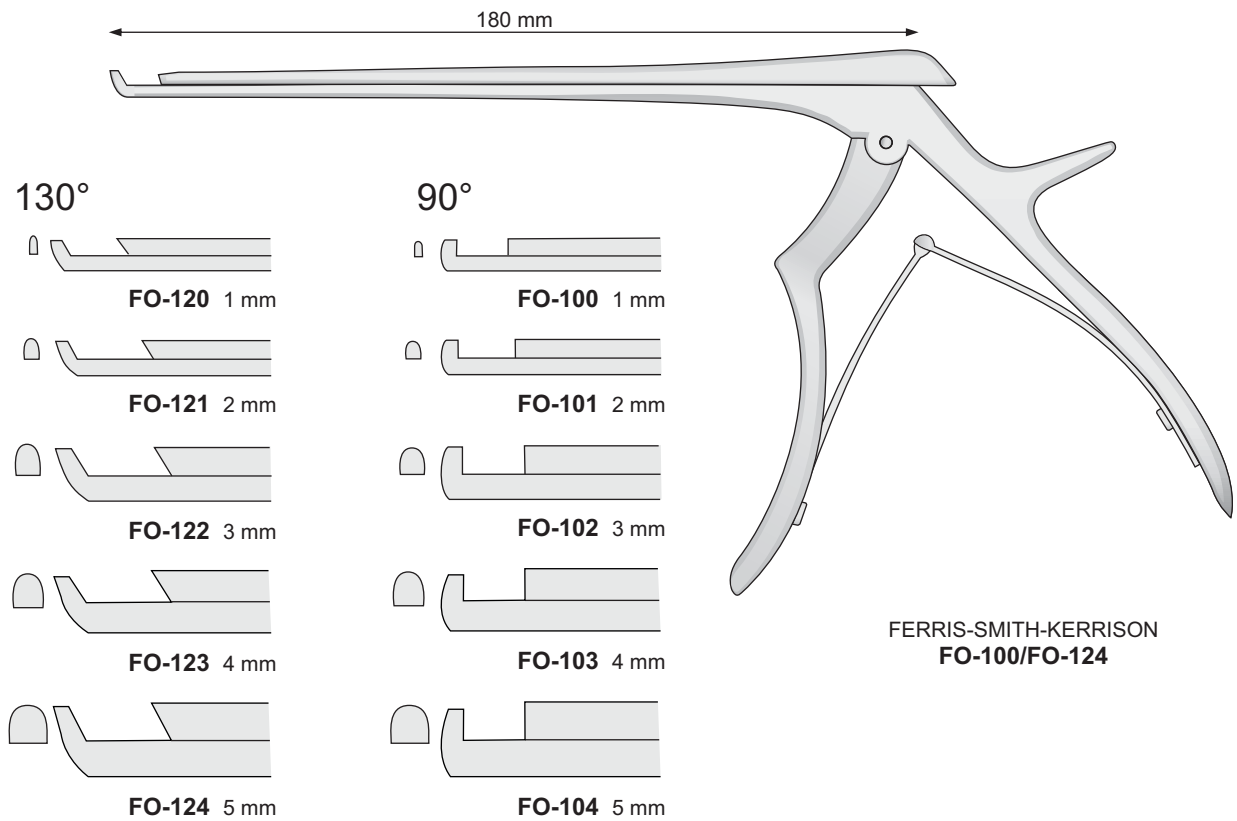

FERRIS-SMITH-KERRISON
FO-100/FO-124

13

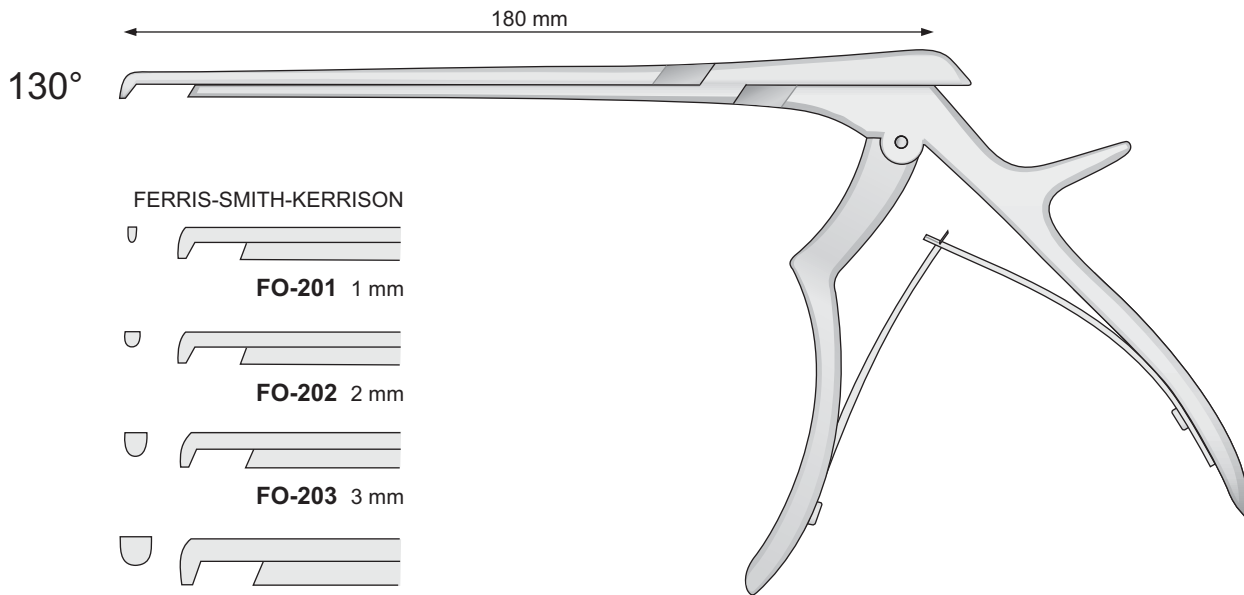

FO-201/FO-205

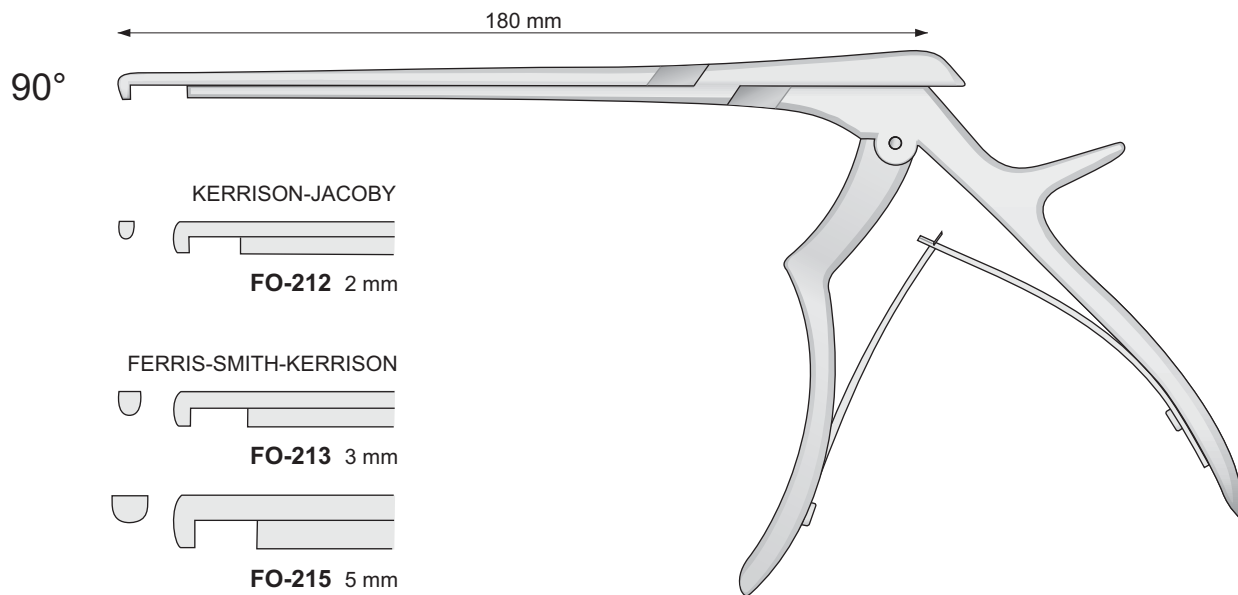

FO-212/FO-215

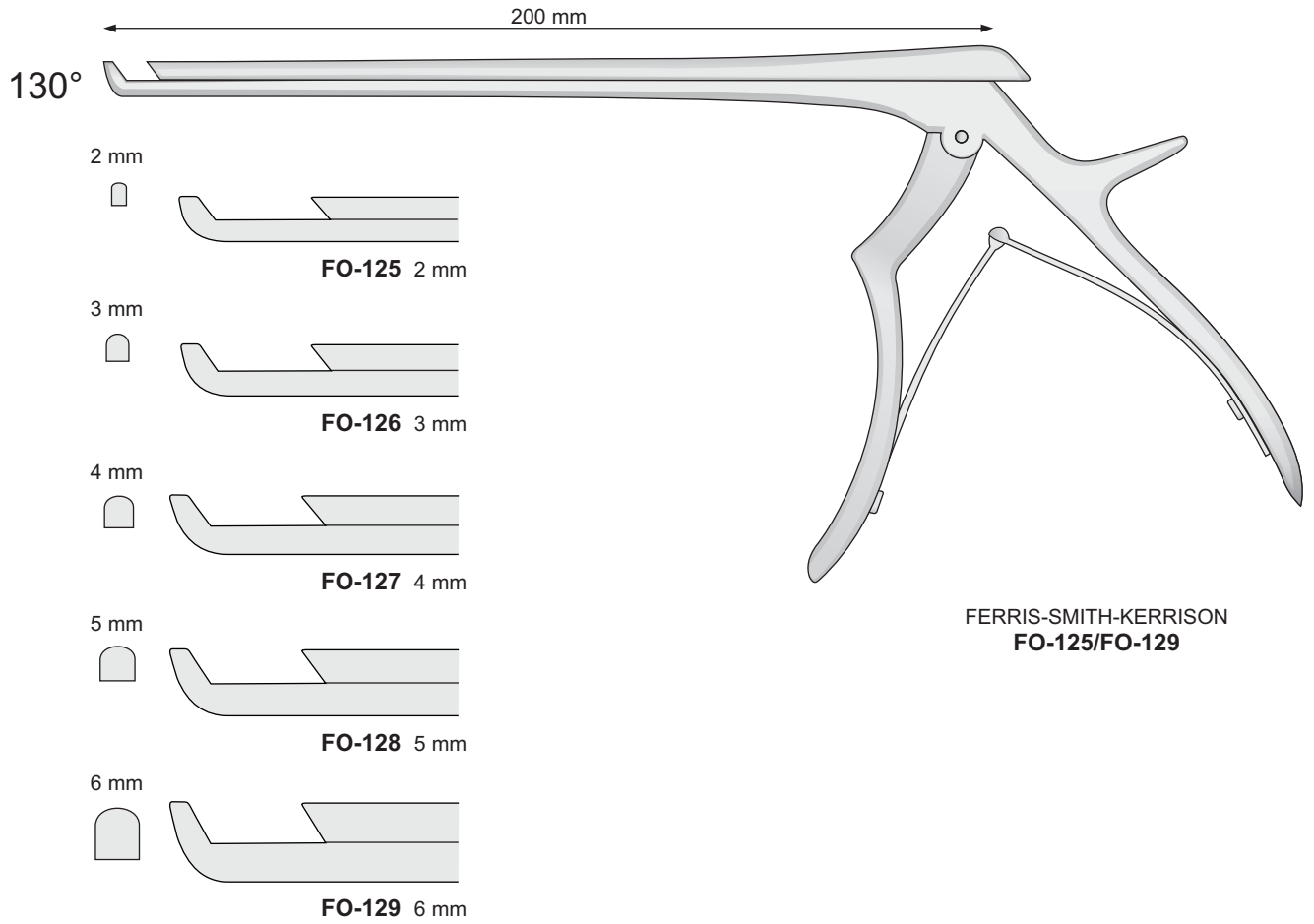

Laminotomo cervicale - Cervical Laminectomy

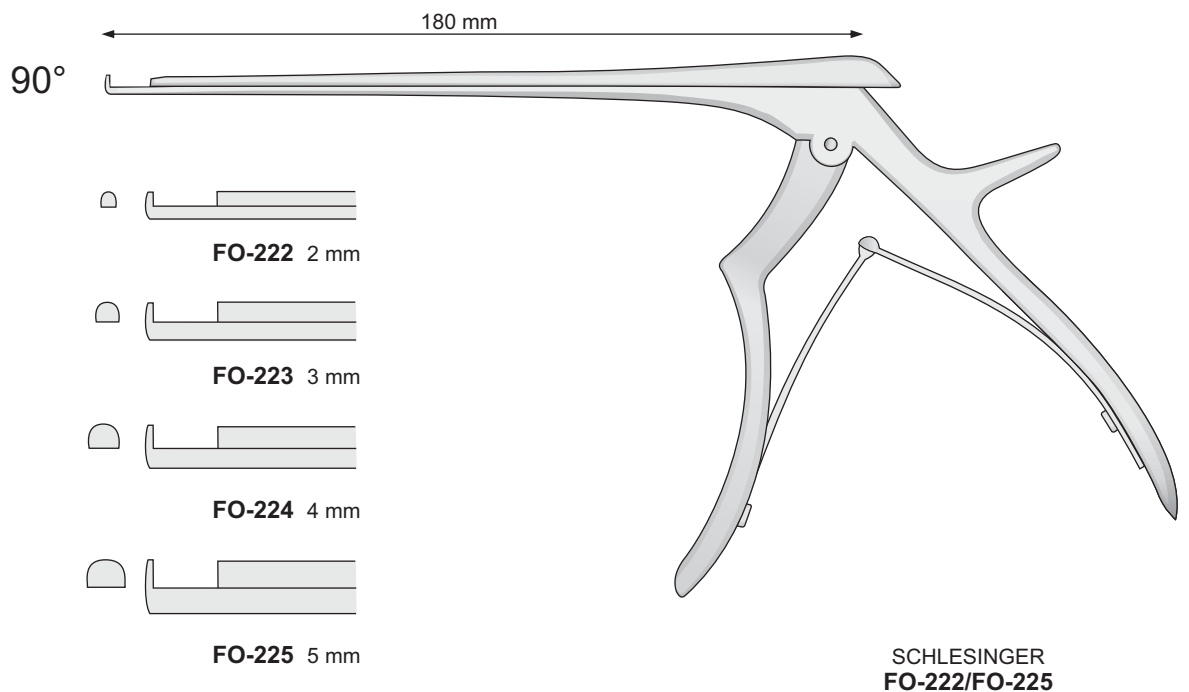

13

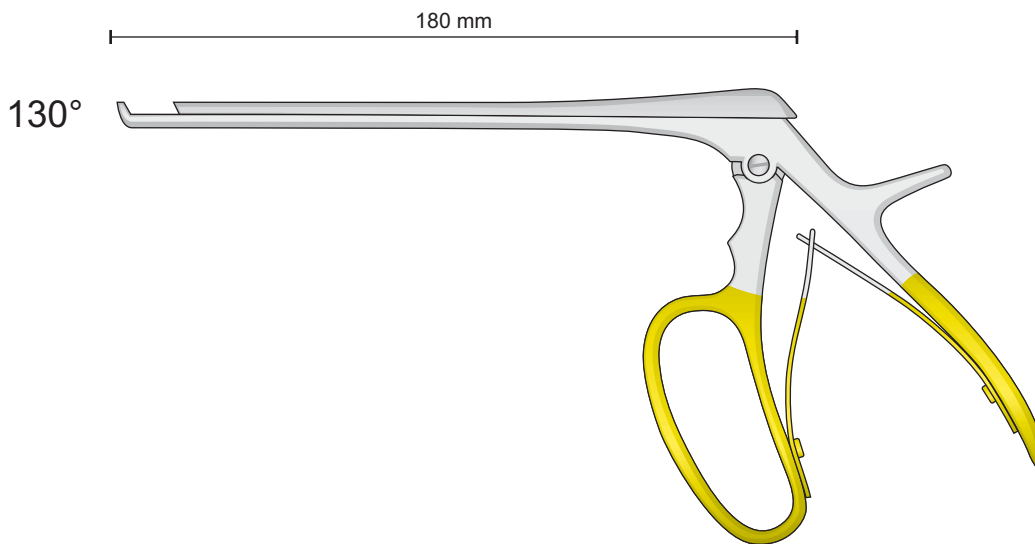
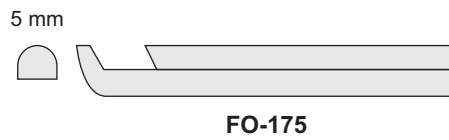
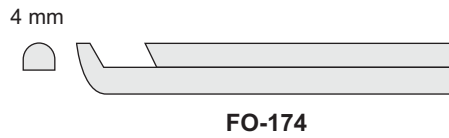
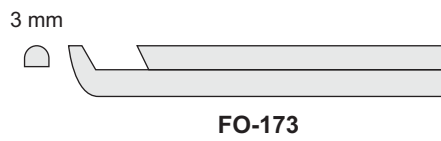
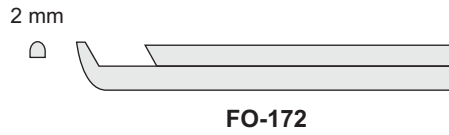

FERRIS - SMITH - KERRISON
FO-171/FO-175

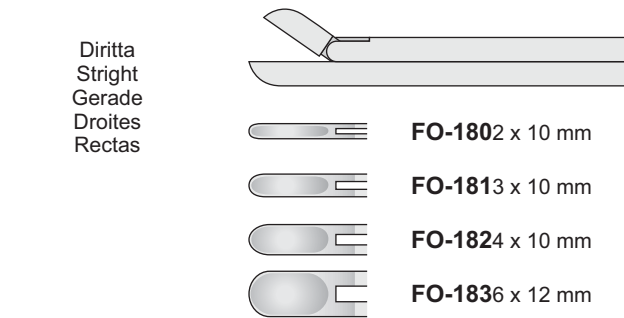

Curva verso l'alto
Top curved
Aufwärtsgebogen
Courbe vers le haut
Curvos

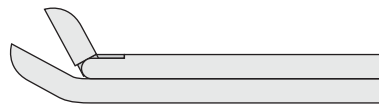

Curva verso il basso
Bottom curved
Abwärts gebogen
Courbe vers le bas
Curvos

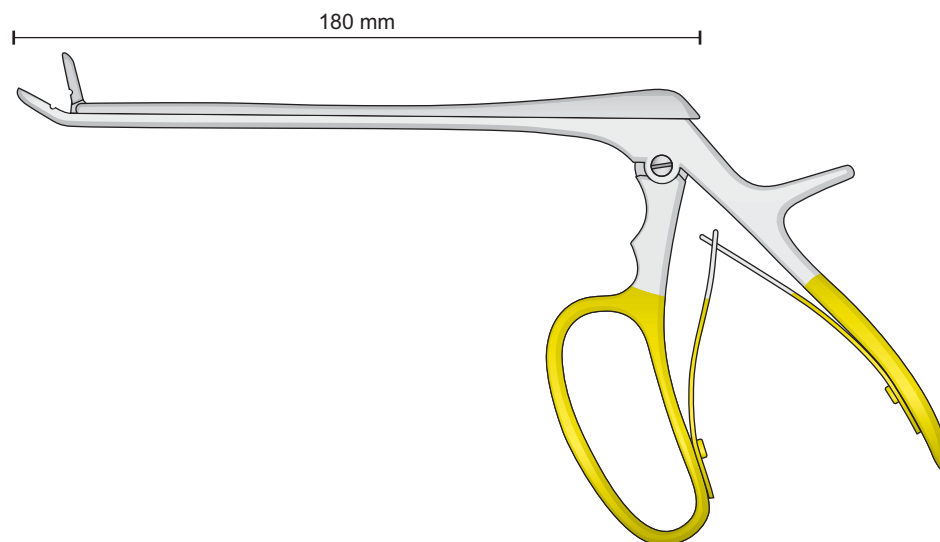
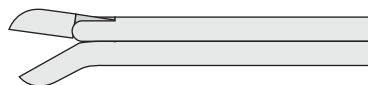

FERRIS - SMITH - CUSHING
FO-180/FO-189

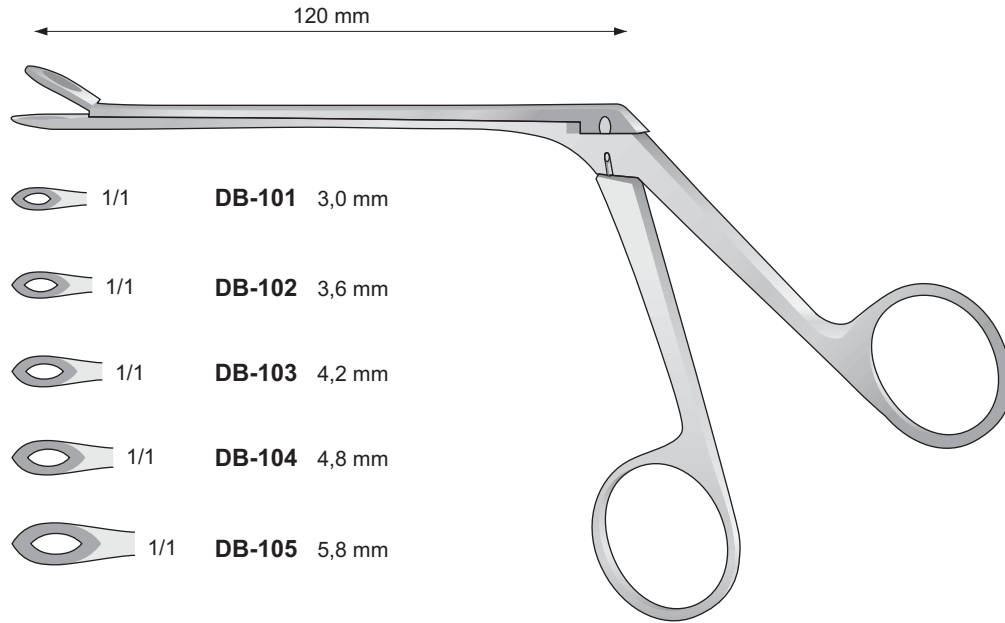

WEIL-BLAKESLEY
DB-101/DB-105
190 mm

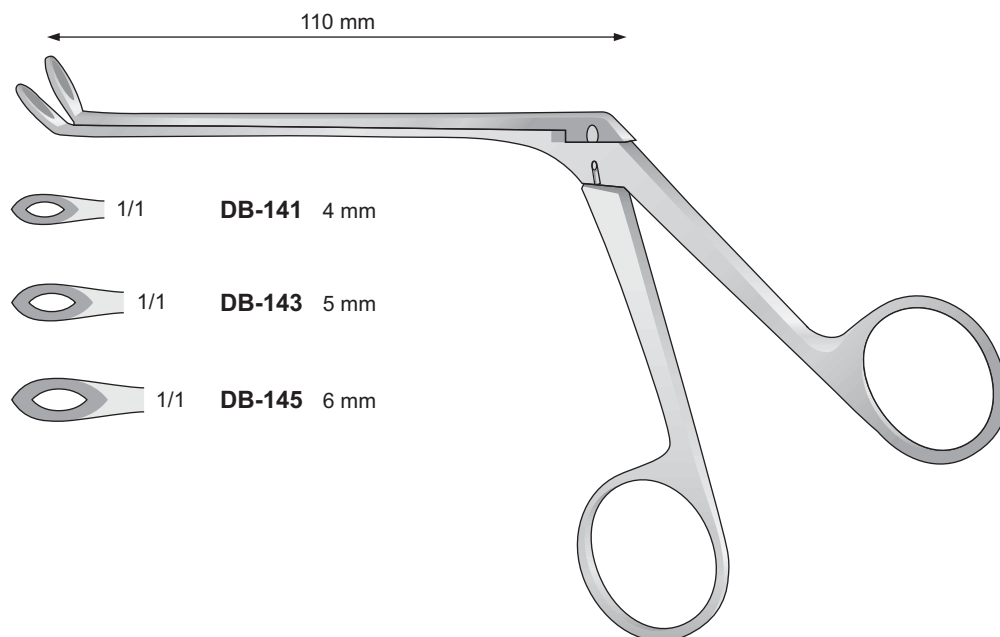

WEIL-BLAKESLEY
DB-141/DB-145
190 mm

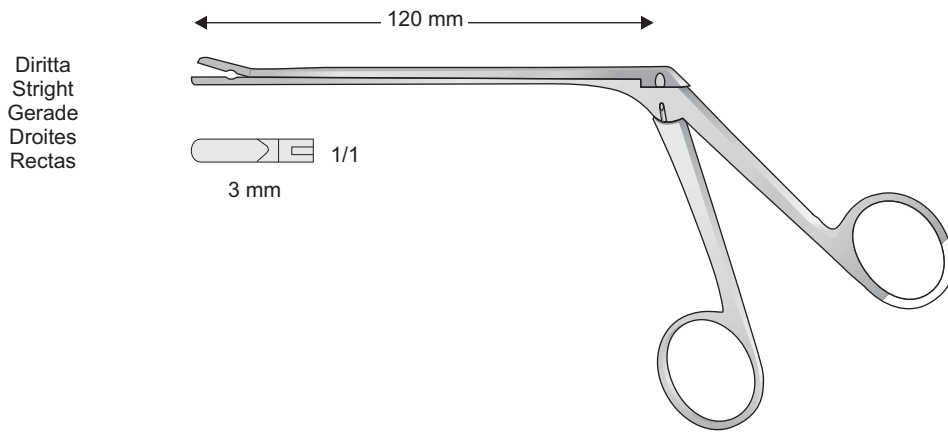

TAKAHASHI
FF-70

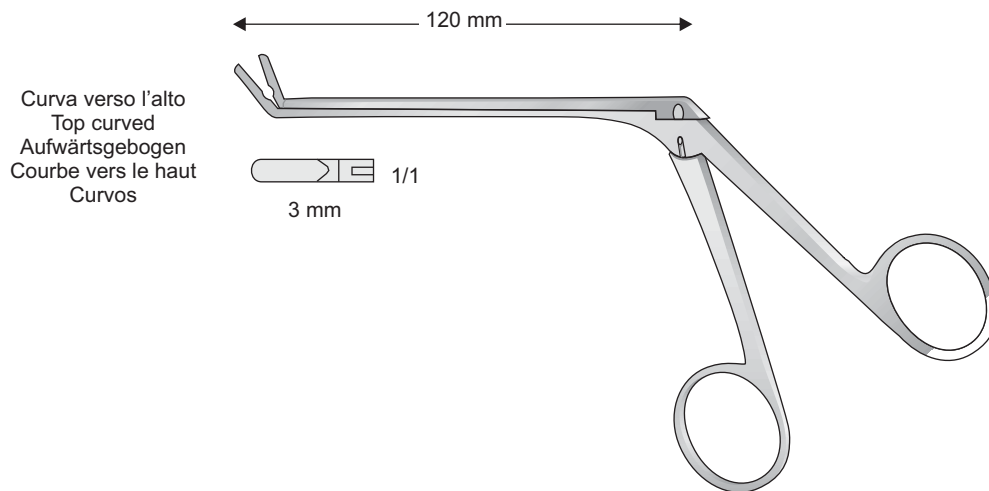

TAKAHASHI
FF-71

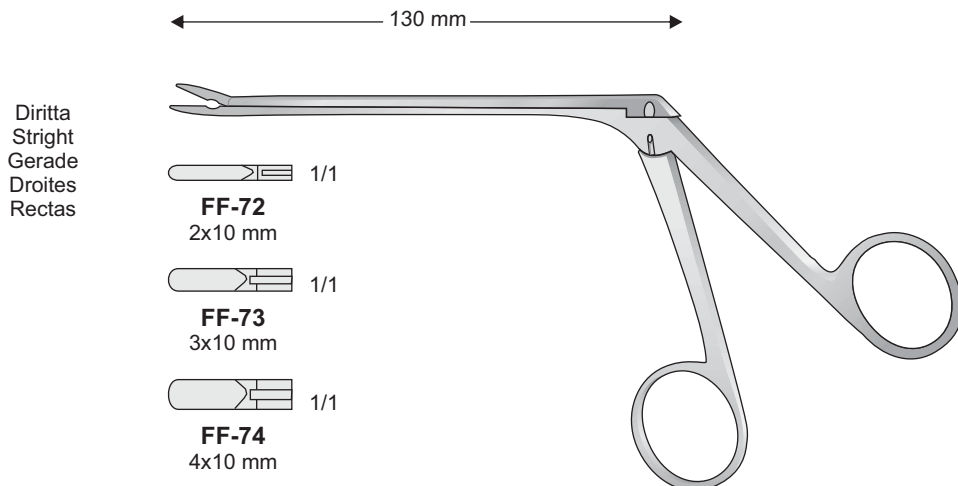

LOVE-GRUENWALD
FF-72/FF-74

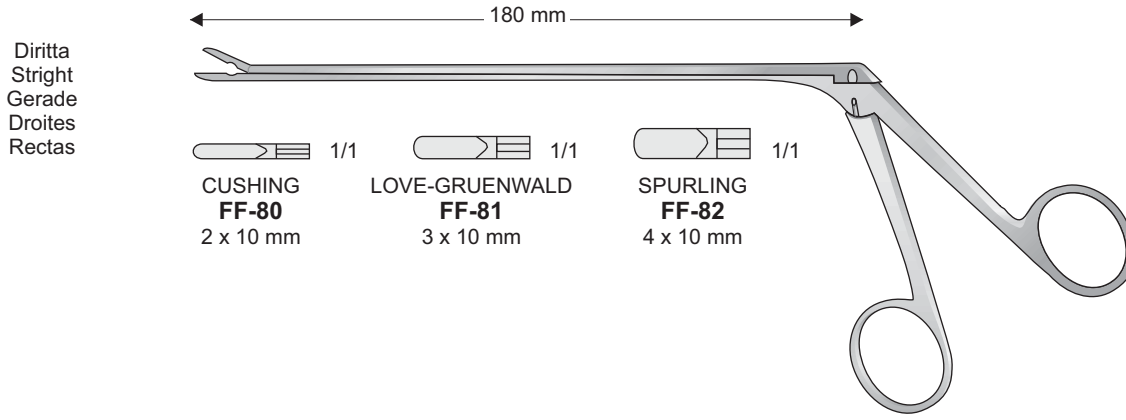

FF-80/FF-82

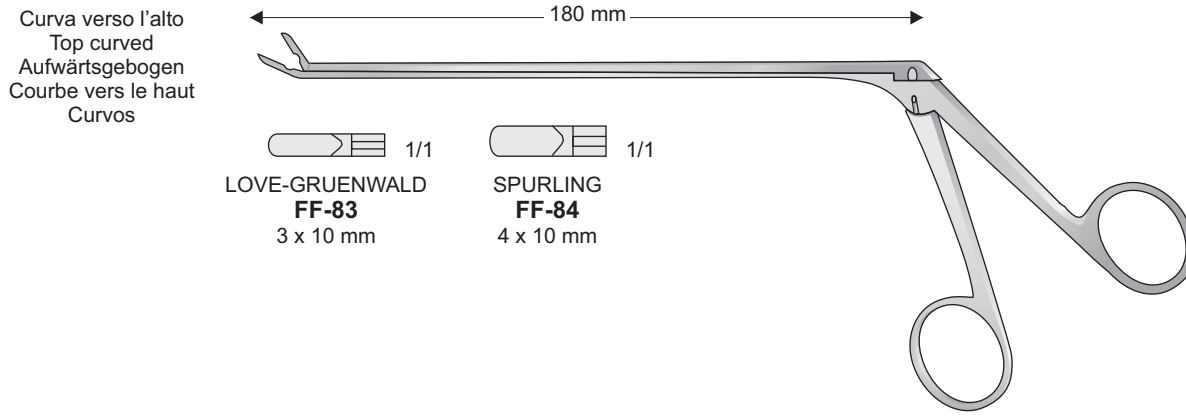



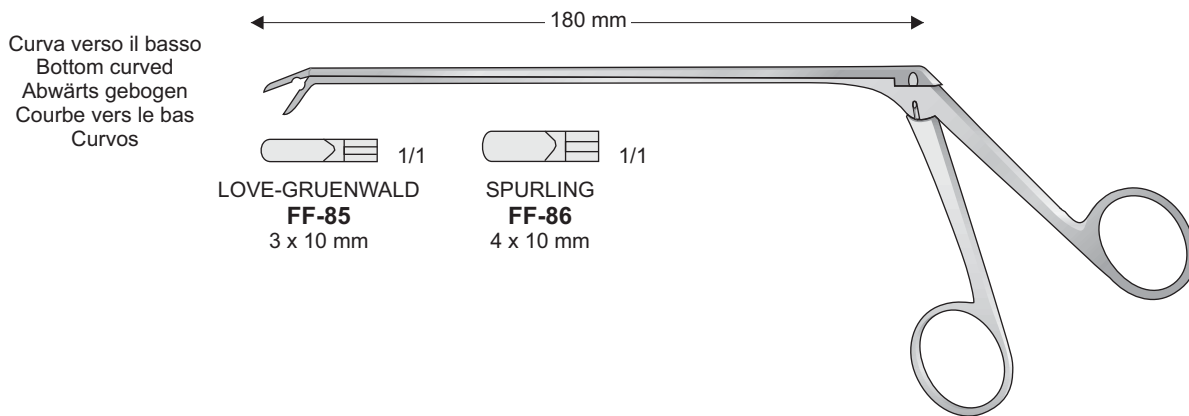

FF-83/FF-84



FF-85/FF-86

155 mm

Diritta
Stright
Gerade
Droites
Rectas

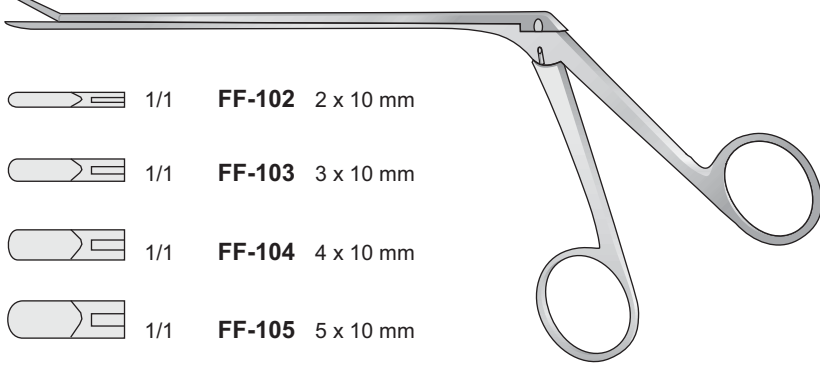

	1/1	FF-102	2 x 10 mm
	1/1	FF-103	3 x 10 mm
	1/1	FF-104	4 x 10 mm
	1/1	FF-105	5 x 10 mm



CASPAR
FF-102/FF-105

155 mm

Curva verso l'alto
Top curved
Aufwärtsgebogen
Courbe vers le haut
Curvos

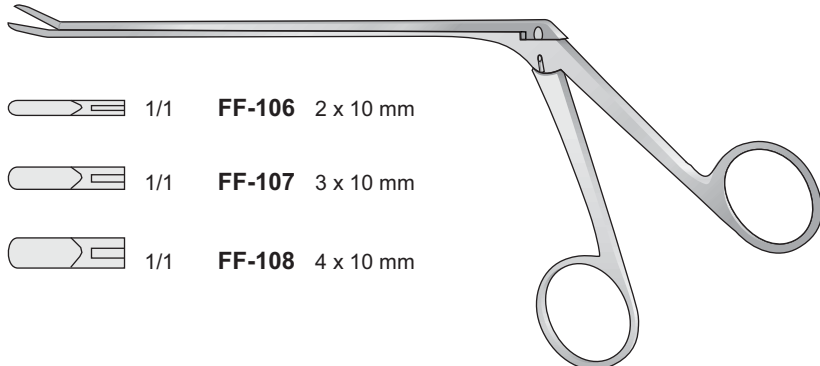

	1/1	FF-106	2 x 10 mm
	1/1	FF-107	3 x 10 mm
	1/1	FF-108	4 x 10 mm



CASPAR
FF-106/FF-108

155 mm

Curva verso il basso
Bottom curved
Abwärts gebogen
Courbe vers le bas
Curvos

	1/1	FF-109	2 x 10 mm
	1/1	FF-110	3 x 10 mm
	1/1	FF-111	4 x 10 mm

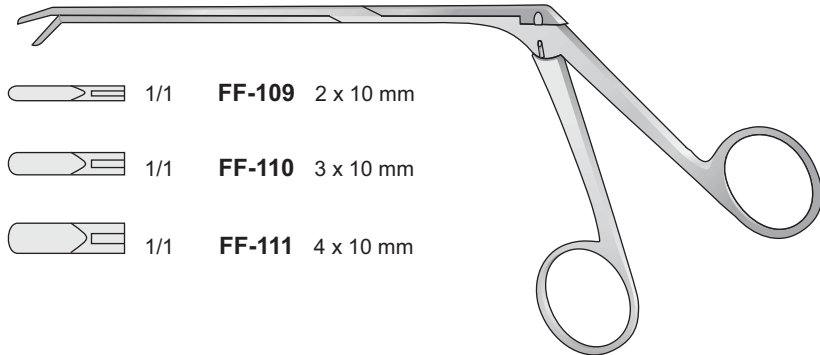

CASPAR
FF-109/FF-111

Diritta
Stright
Gerade
Droites
Rectas

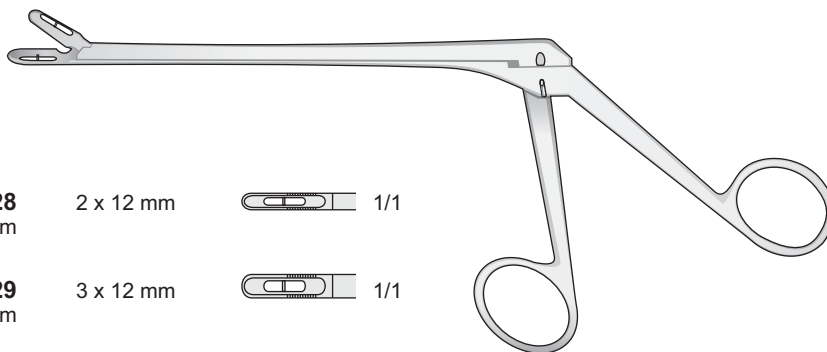

CASPAR

FF-120 140 mm	FF-123 160 mm	FF-128 185 mm	2 x 12 mm		1/1
FF-121 140 mm	FF-124 160 mm	FF-129 185 mm	3 x 12 mm		1/1
FF-122 140 mm	FF-125 160 mm	FF-130 185 mm	4 x 14 mm		1/1
	FF-126 160 mm	FF-131 185 mm	5 x 14 mm		1/1
	FF-127 160 mm	FF-132 185 mm	6 x 16 mm		1/1

CASPAR
FF-120/FF-132

Curva verso l'alto
Top curved
Aufwärtsgebogen
Courbe vers le haut
Curvos

150°

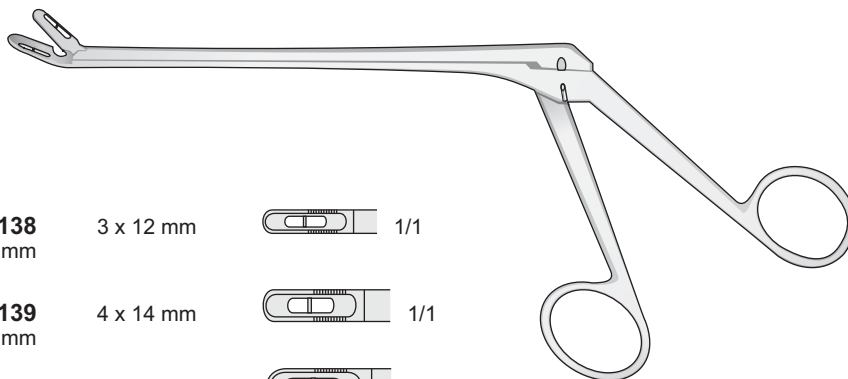

CASPAR

FF-133 140 mm	FF-135 160 mm	FF-138 185 mm	3 x 12 mm		1/1
FF-134 140 mm	FF-136 160 mm	FF-139 185 mm	4 x 14 mm		1/1
	FF-137 160 mm	FF-140 185 mm	5 x 14 mm		1/1

CASPAR
FF-133/FF-140

Curva verso il basso
Bottom curved
Abwärts gebogen
Courbe vers le bas
Curvos

150°

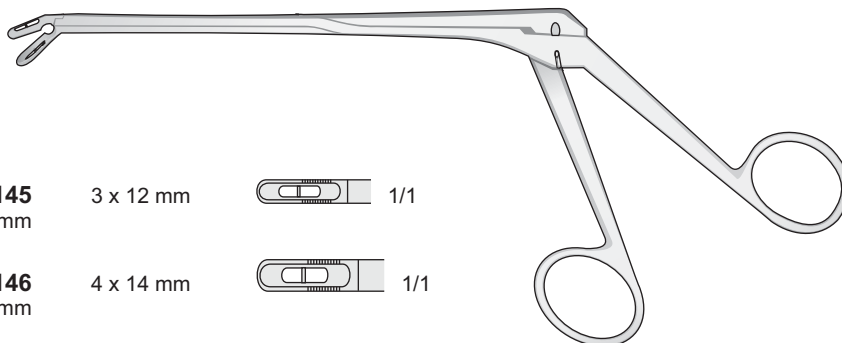

CASPAR

FF-141 140 mm	FF-143 160 mm	FF-145 185 mm	3 x 12 mm		1/1
FF-142 140 mm	FF-144 160 mm	FF-146 185 mm	4 x 14 mm		1/1

CASPAR
FF-141/FF-146

Diritta
Stright
Gerade
Droites
Rectas

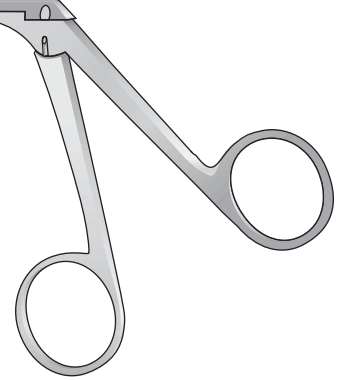
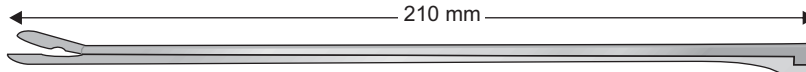

WAGNER
FF-90

Diritta
Stright
Gerade
Droites
Rectas

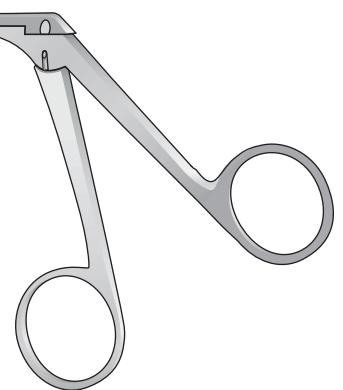
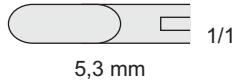
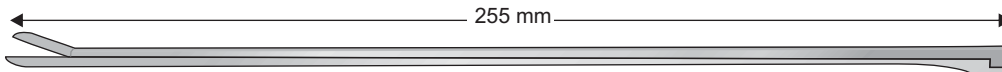

FF-91

Curva verso l'alto
Top curved
Aufwärtsgebogen
Courbe vers le haut
Curvos

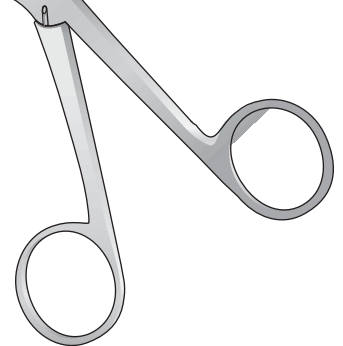
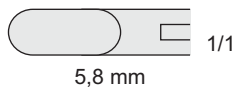
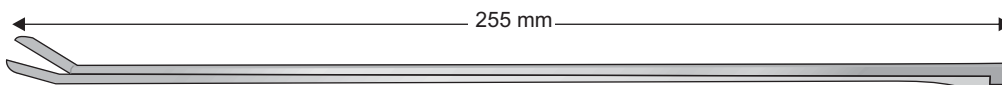

SYPERT
FF-92

Diritta
Stright
Gerade
Droites
Rectas

180 mm

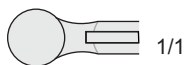
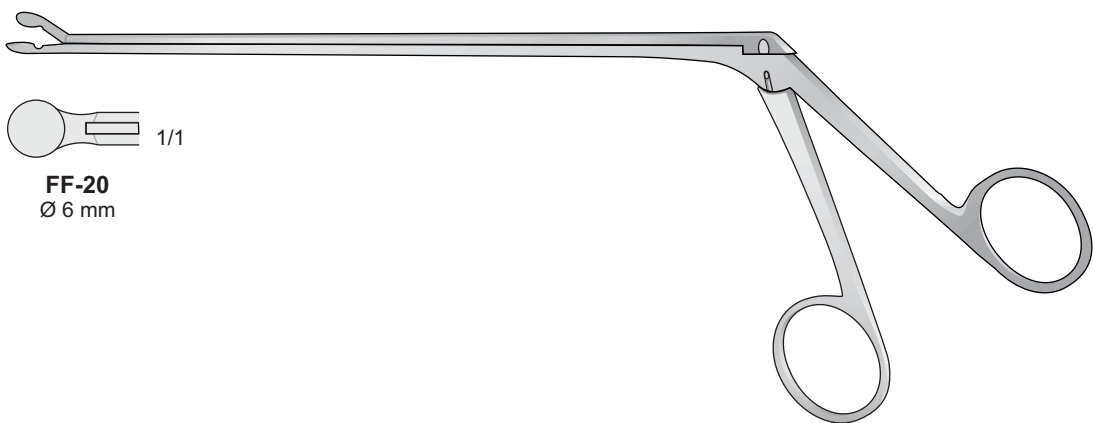

FF-20
Ø 6 mm

OLDBERG
FF-20

Diritta
Stright
Gerade
Droites
Rectas

190 mm

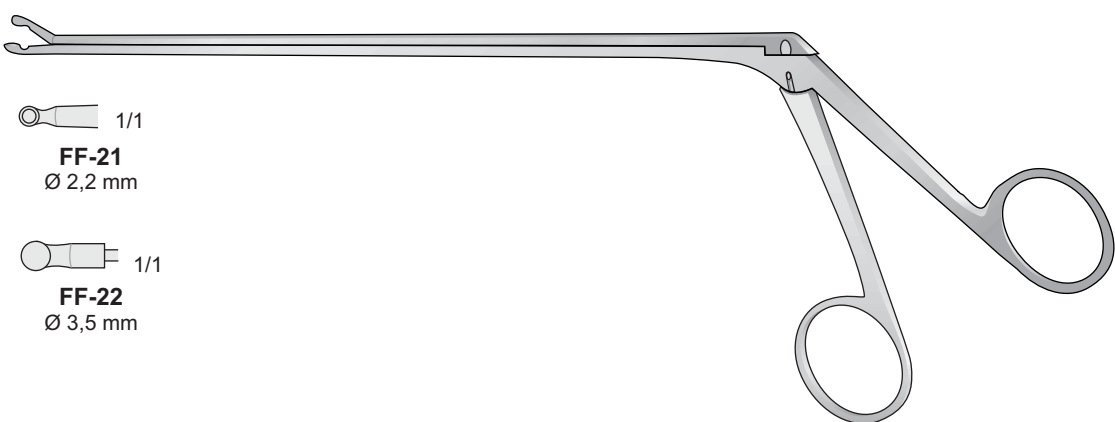

FF-21
Ø 2,2 mm



FF-22
Ø 3,5 mm

YASARGIL
FF-21/FF-22

Diritta
Stright
Gerade
Droites
Rectas

200 mm

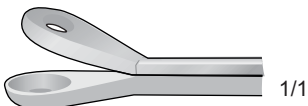
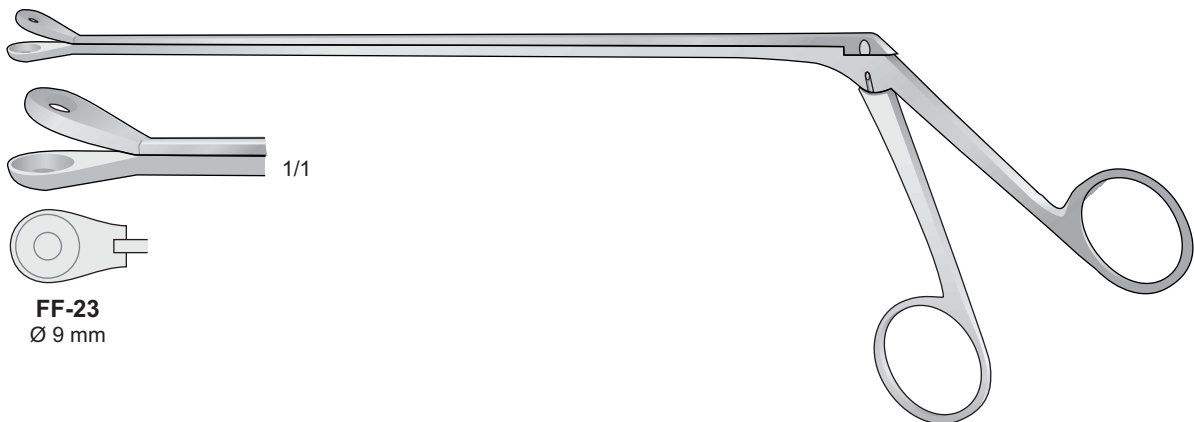

FF-23
Ø 9 mm

LANDOLT
FF-23

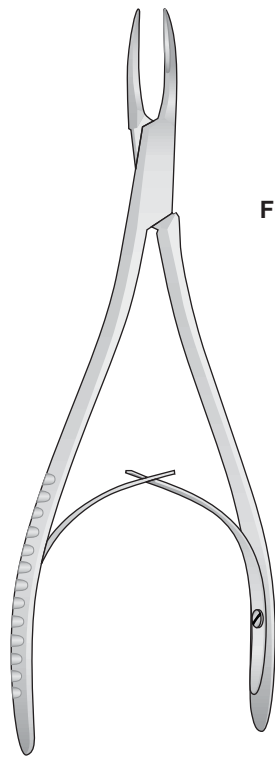

MINI-FRIEDMANN
FO-22/FO-24
150 mm

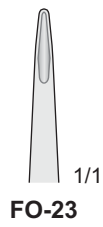

FO-23

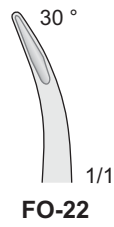

FO-22

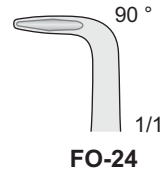

FO-24

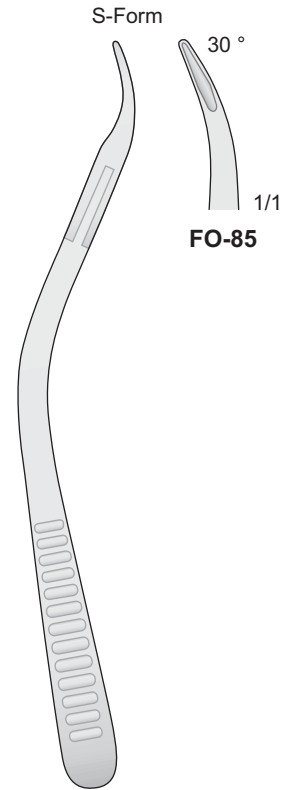

MINI-FRIEDMANN
FO-85
145 mm

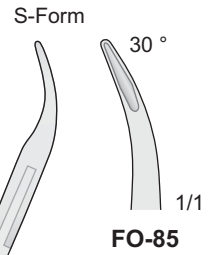

FO-85

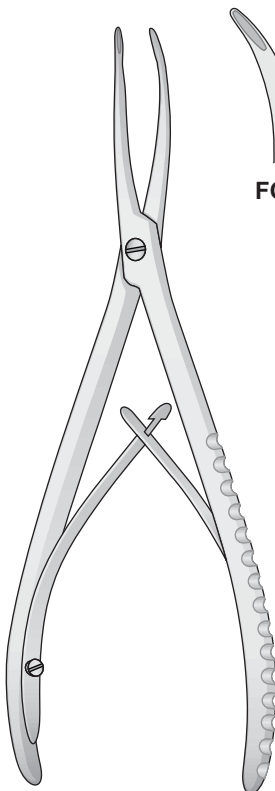

STELLBRINK
FO-88/FO-89
170 mm

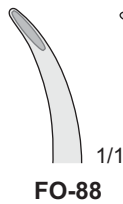

FO-88

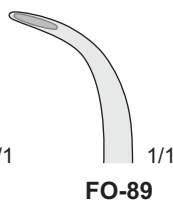

FO-89

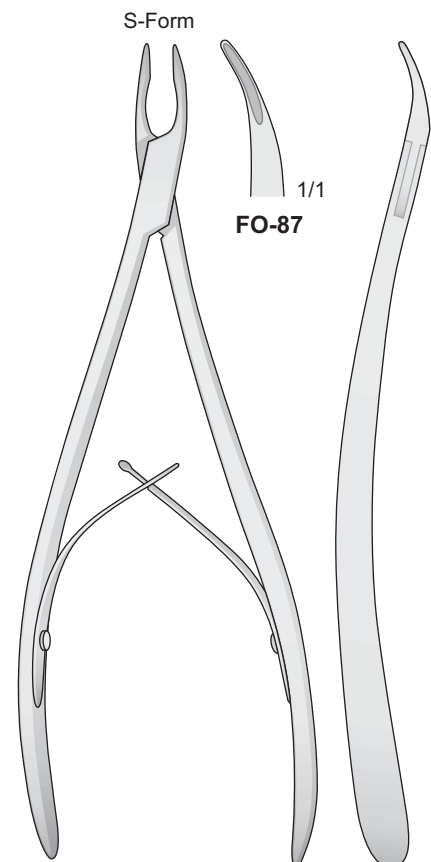

STELLBRINK
FO-87
190 mm



FO-87

13

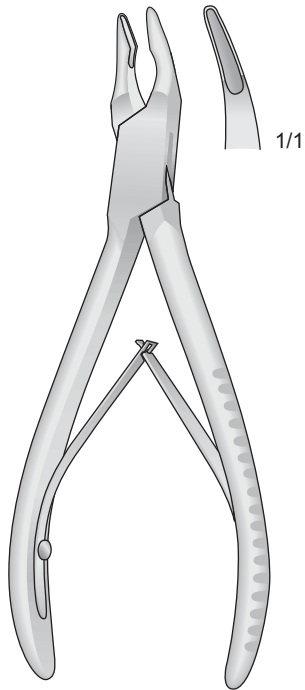

MINI FRIEDMANN
FO-15
120 mm

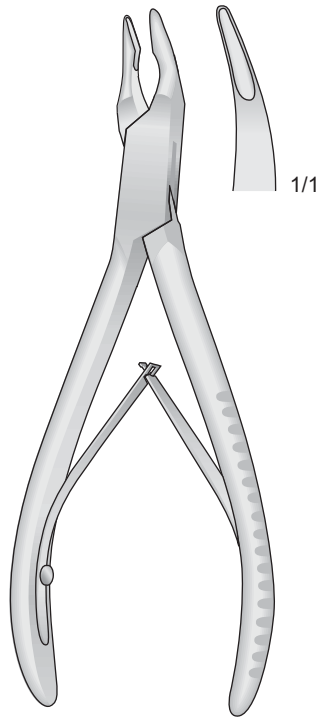

FRIEDMANN
FO-17
140 mm

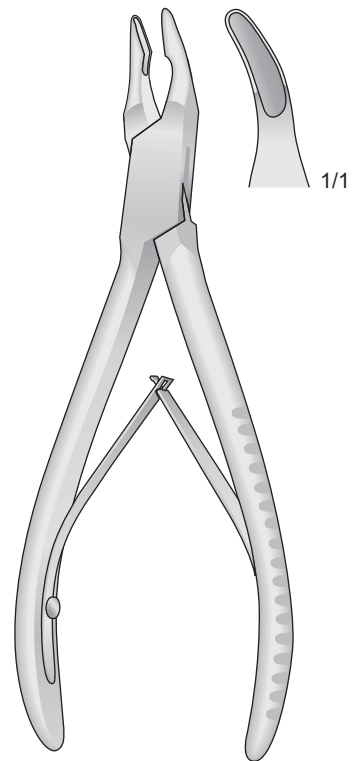

BLUMENTHAL
FO-19
155 mm

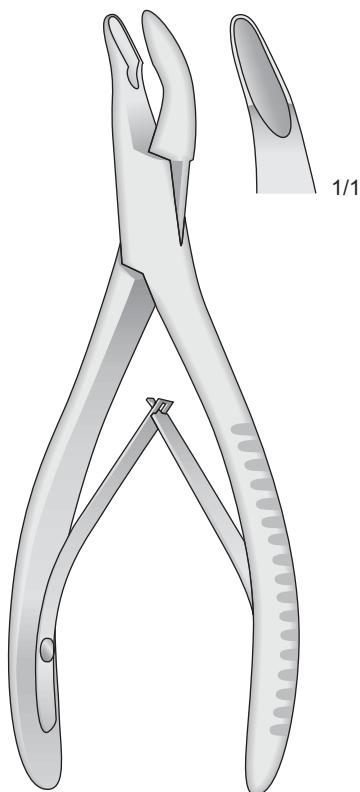

MEAD
FO-21
165 mm

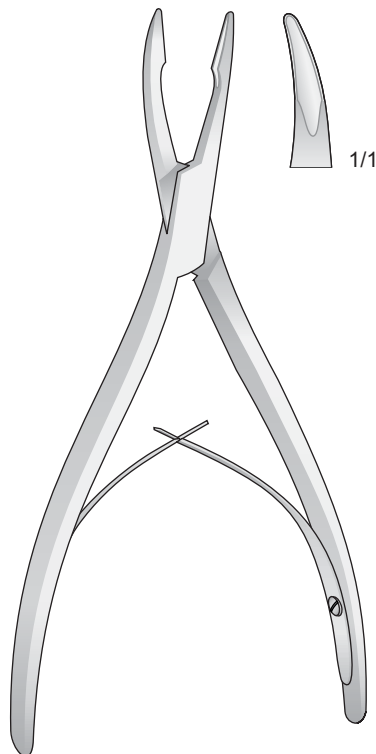

FRIEDMANN
FO-16
160 mm

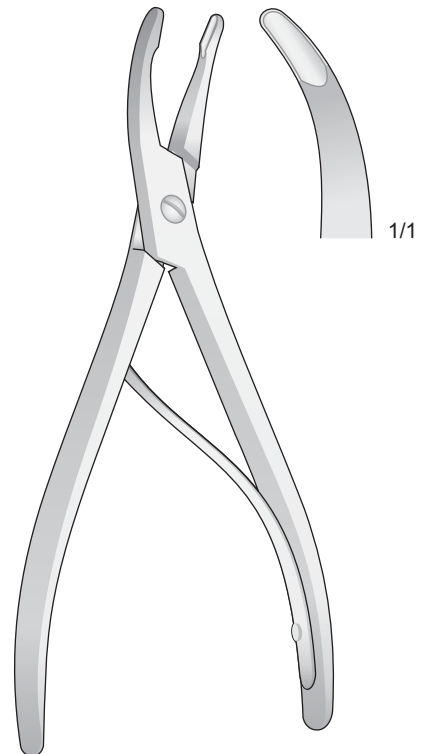

LUER
FO-18
155 mm

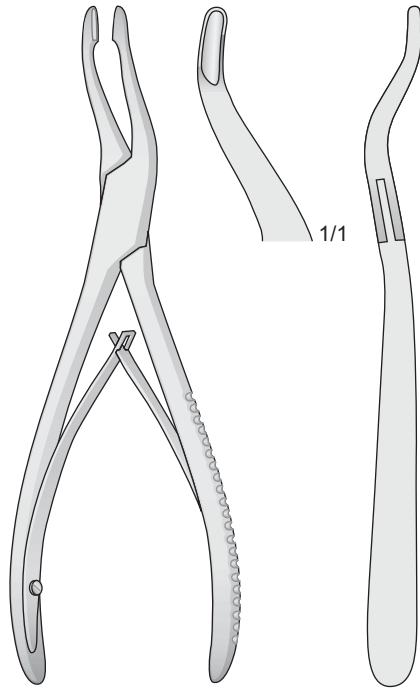

ALEXANDER
FO-27
140 mm

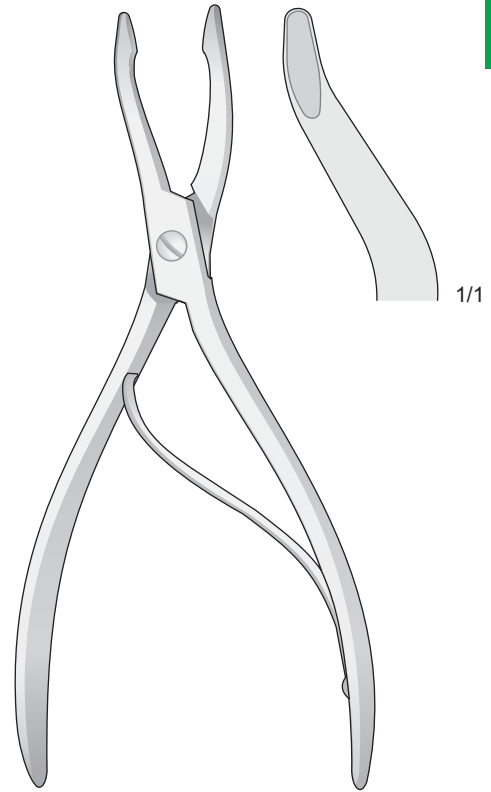

JANSEN-LEUER
FO-10
180 mm

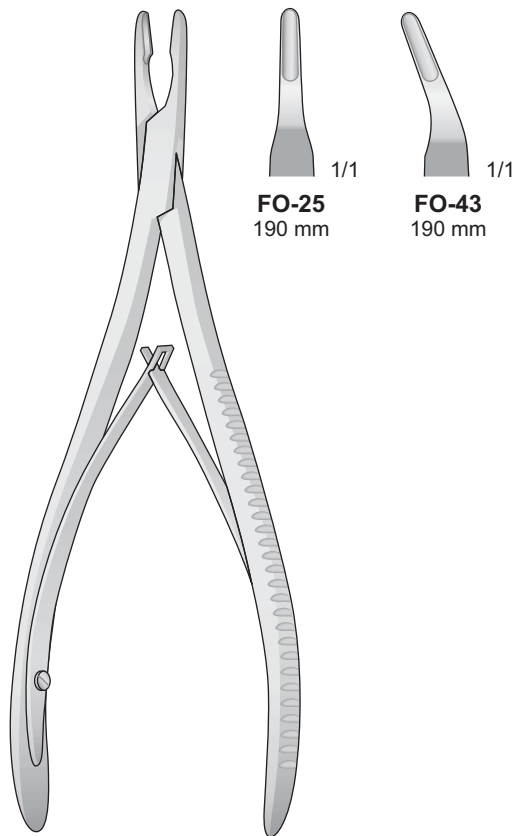

LEMPERT
FO-25/FO-43
190 mm

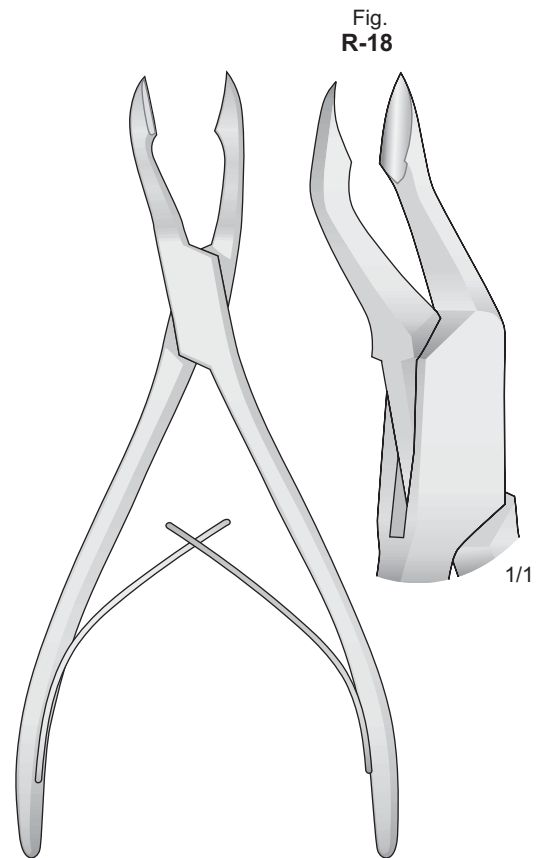

FO-33
175 mm

Fig.
R-18

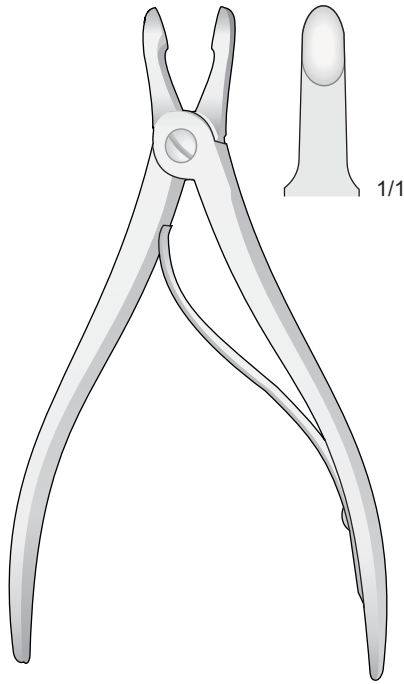

HARTMANN
FO-14
155 mm

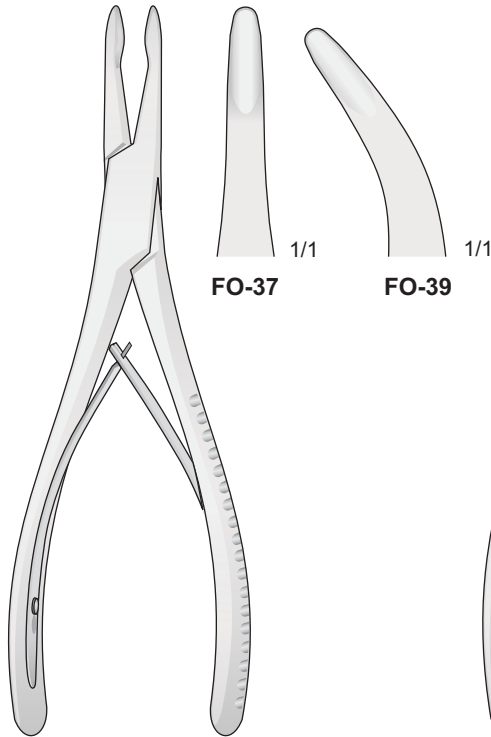

JANSEN
FO-37/FO-39
170 mm

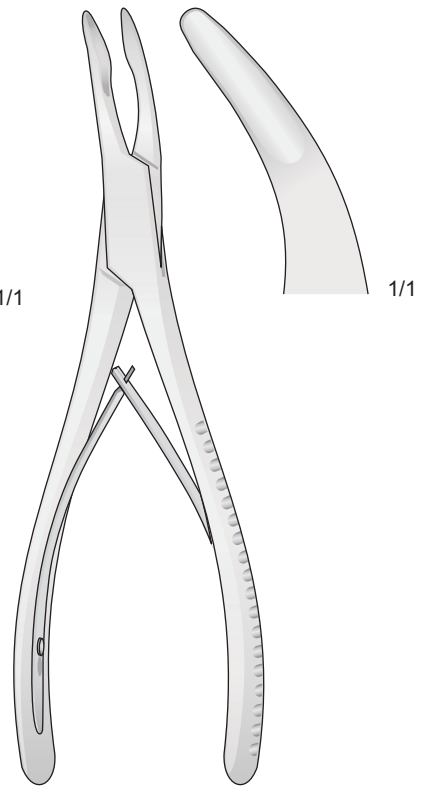

OLIVECRONA
FO-45
190 mm

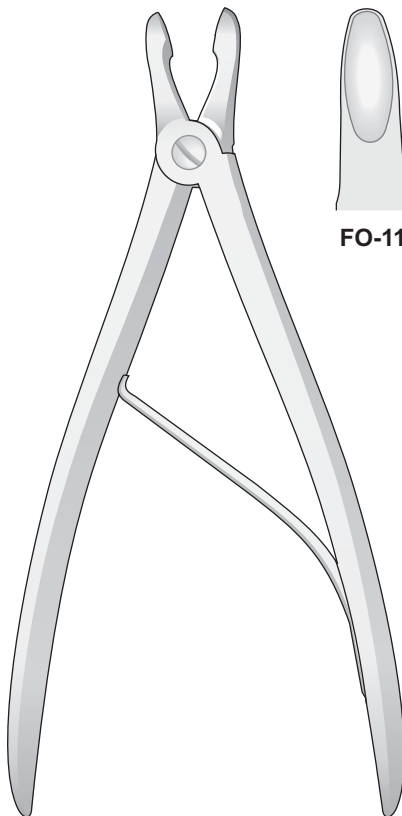

CUSHING
FO-11/FO-12
190 mm

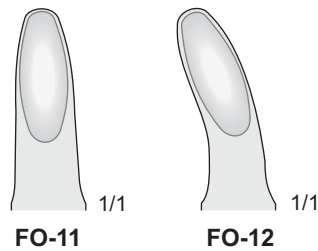

FO-11

FO-12

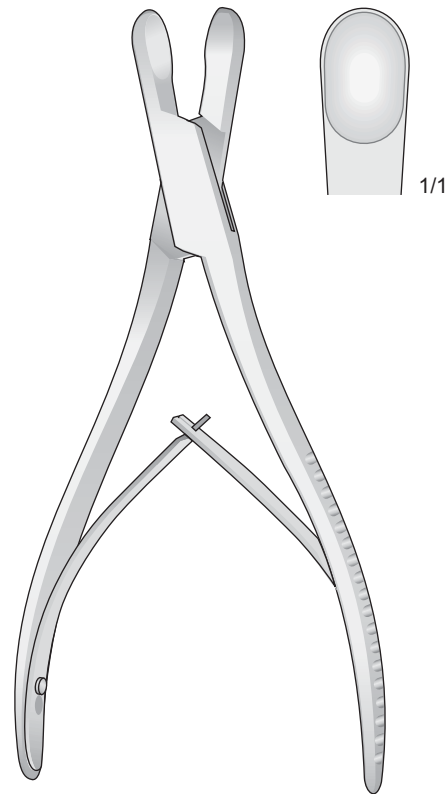

LUER-STILLE
FO-13
185 mm

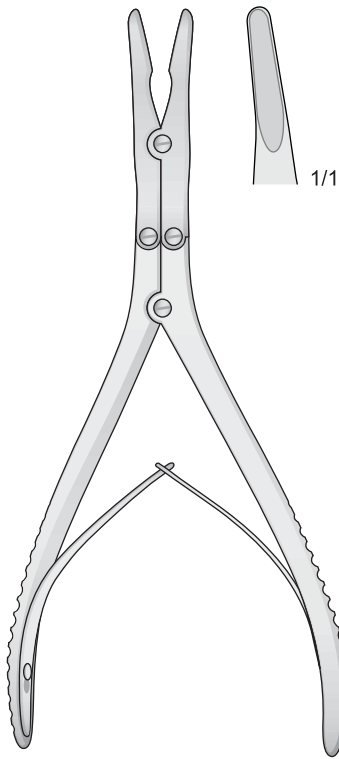

BEYER
FO-20
180 mm

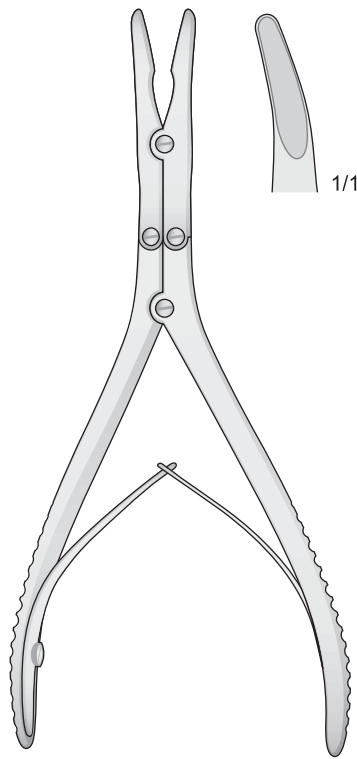

ZAUFAL-JANSEN
FO-34
180 mm

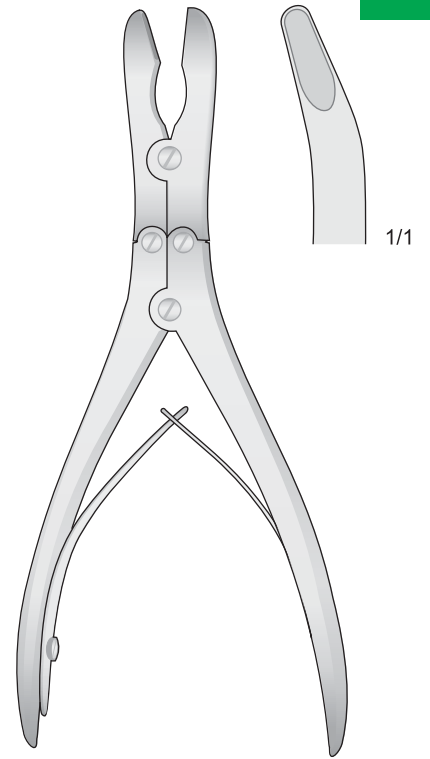

RUSKIN-STILLE
FO-35
180 mm

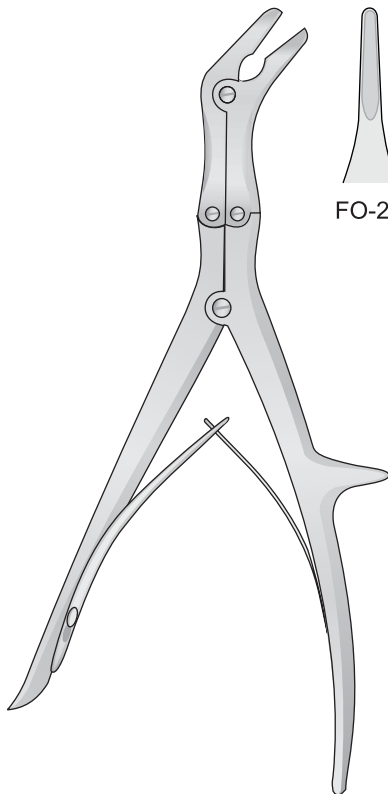

ECHLIN
FO-28/FO-30
230 mm

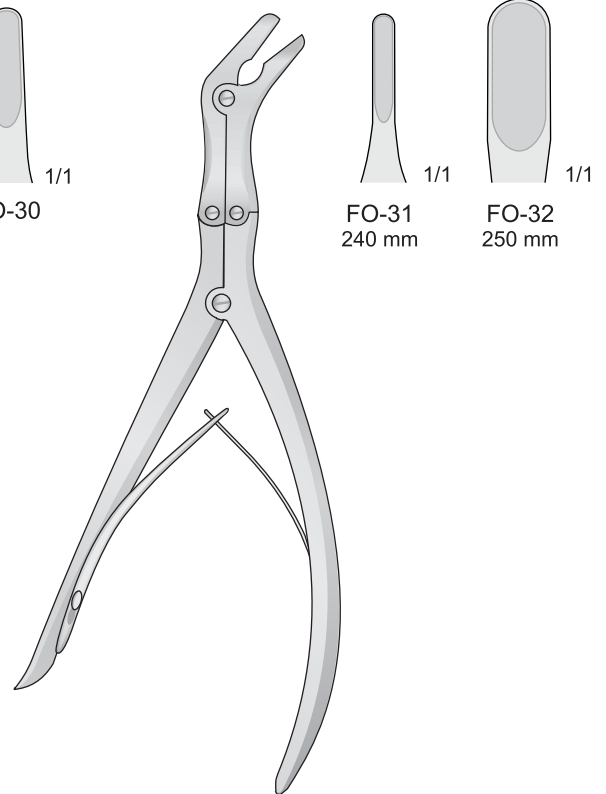
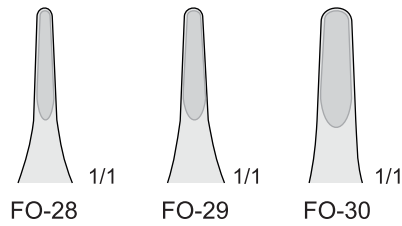

LEKSELL
FO-31/FO-32
240 mm / 250 mm

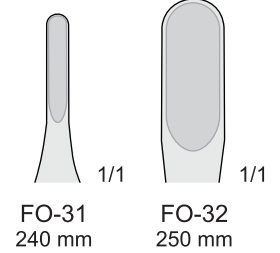

13

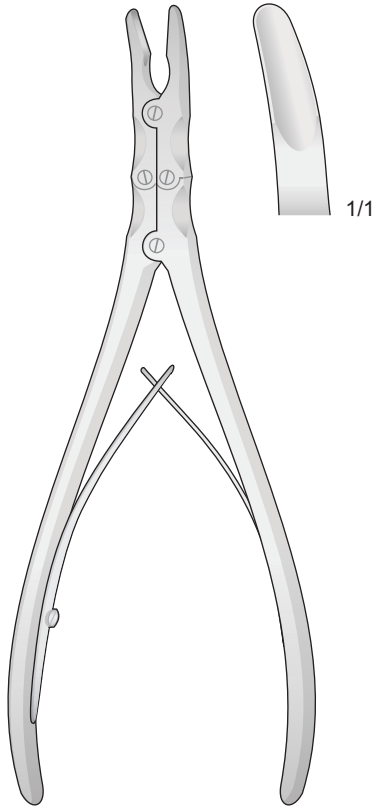

RÖTTGEN-RUSKIN
FO-199
240 mm

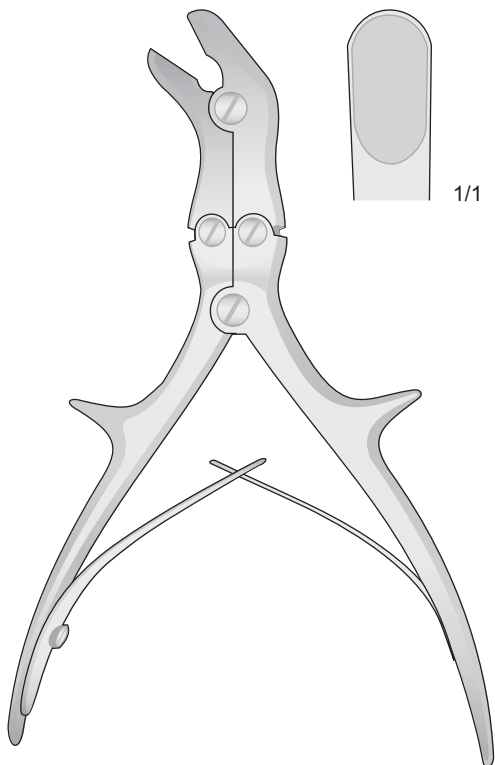

STILLE
FO-36
210 mm

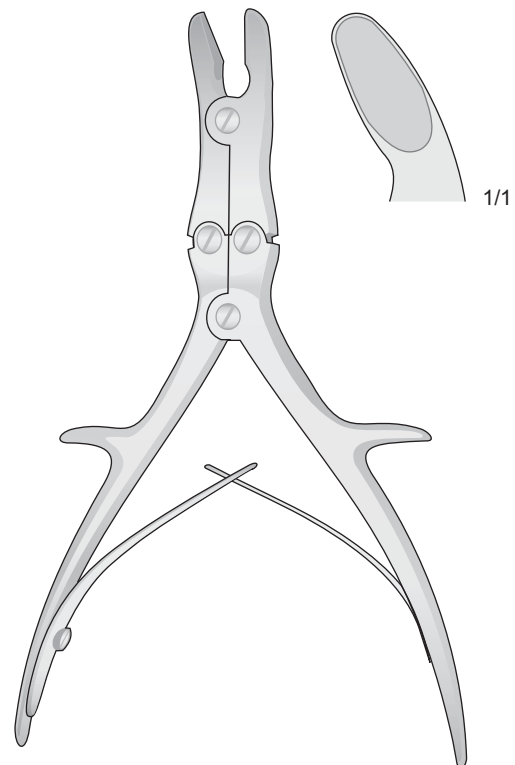

LUER-STILLE
FO-38
210 mm

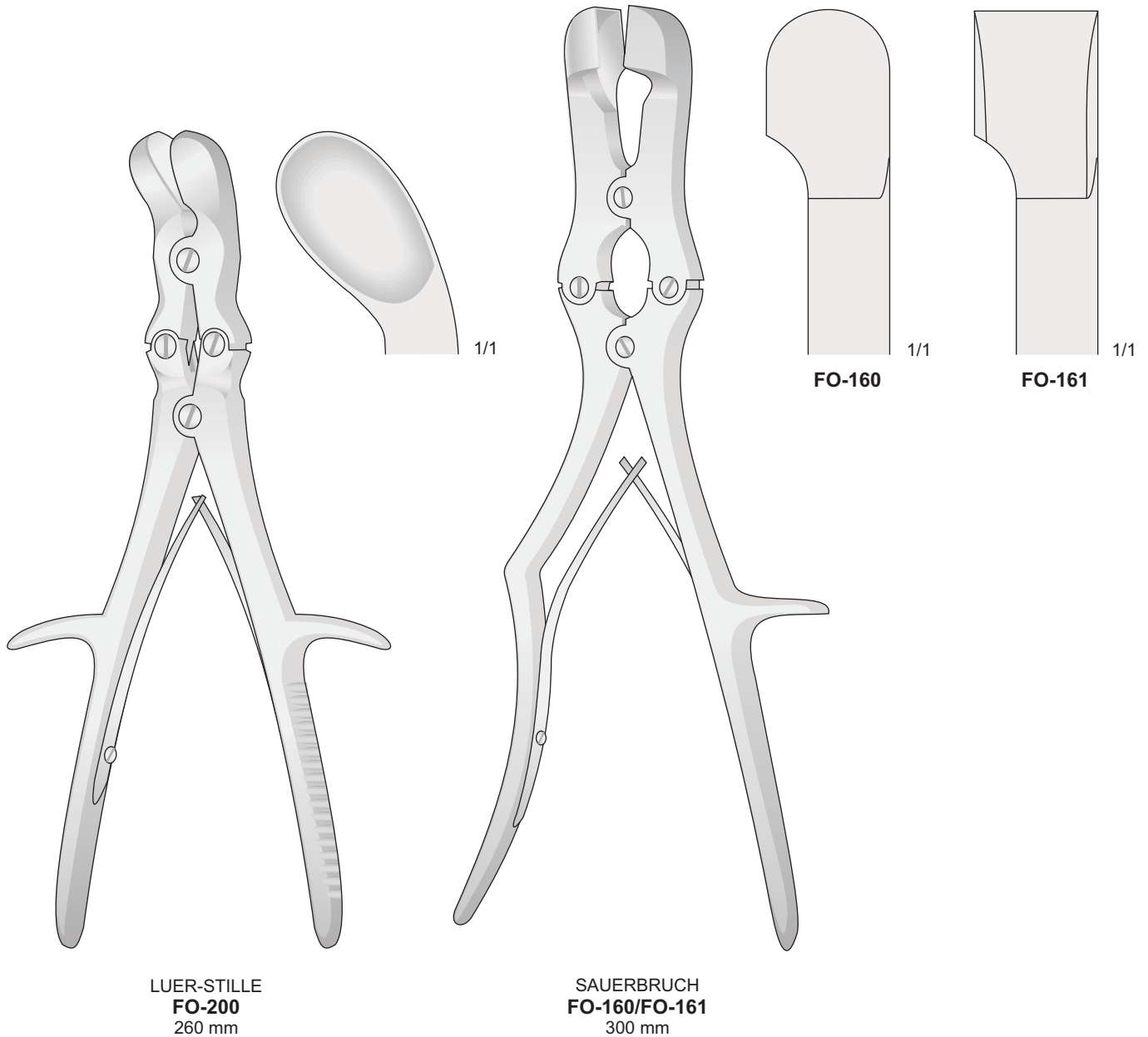

13

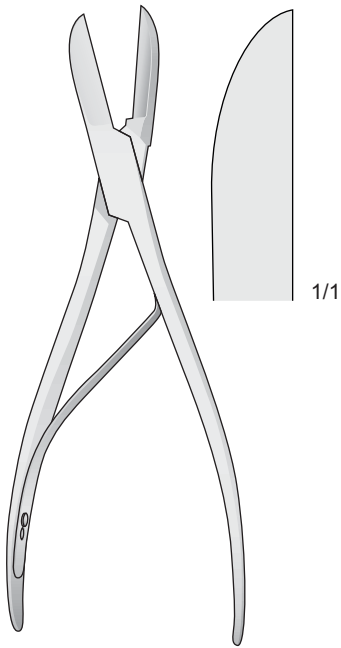

LISTON
LX-108
220 mm

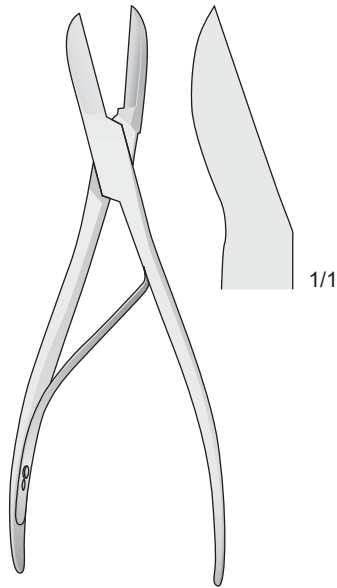

LISTON
LX-109
170 mm

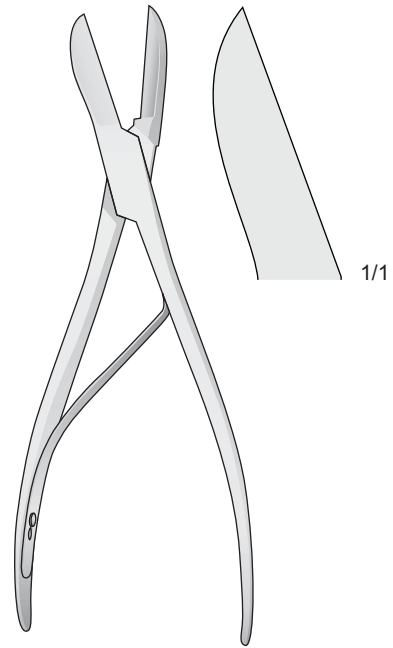

LISTON
LX-110
220 mm

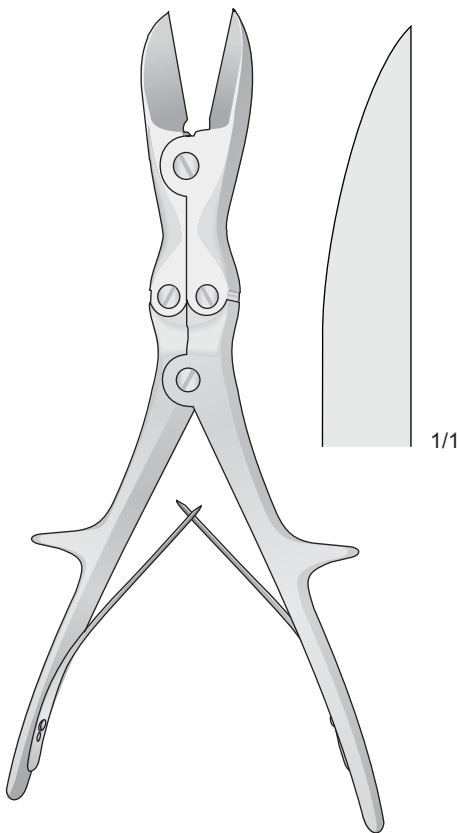

LISTON
FO-41
270 mm

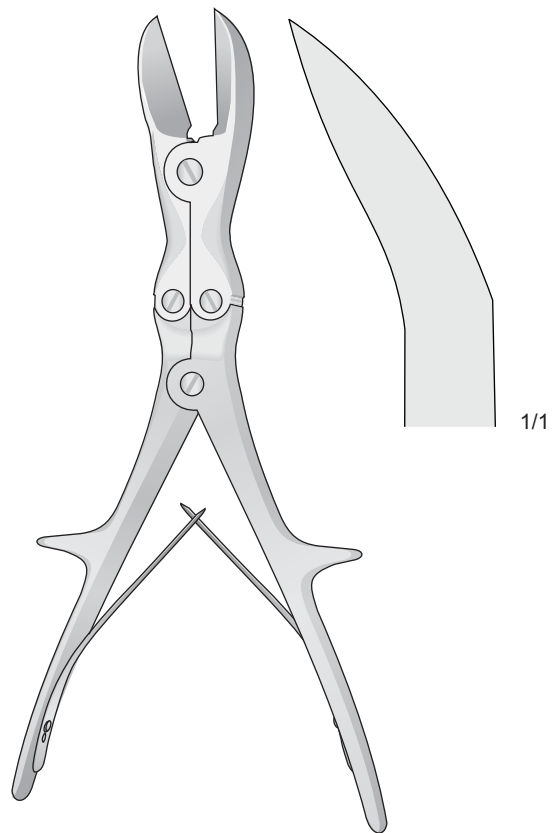

LISTON
FO-42
270 mm

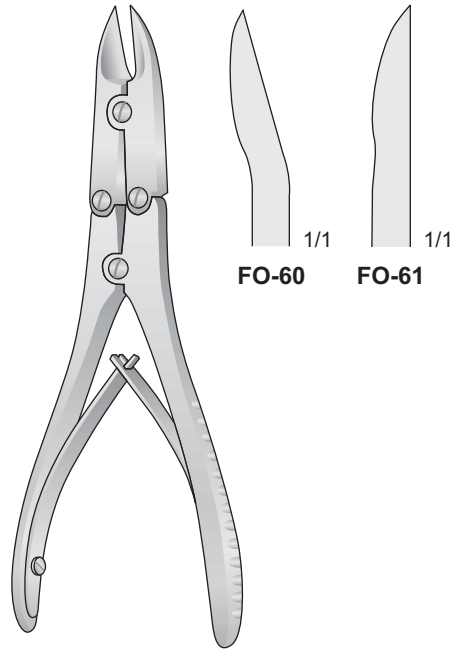

BÖHLER
FO-60/FO-61
150 mm

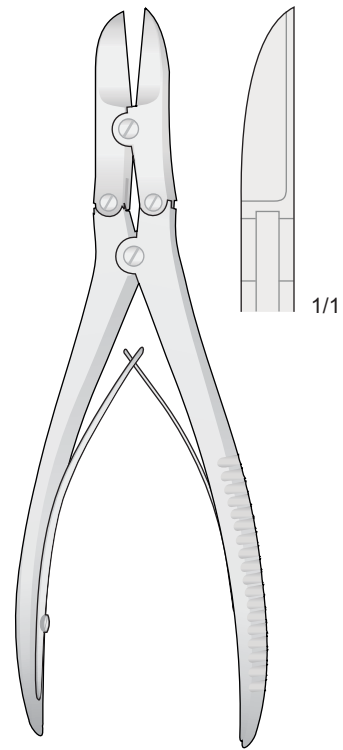

RUSKIN-LISTON
FO-108
190 mm

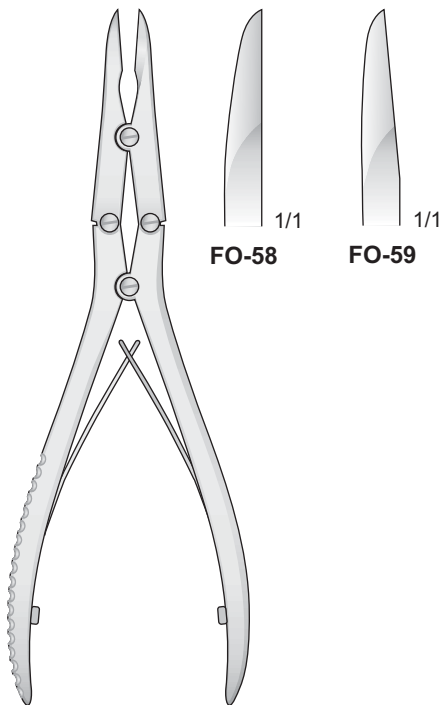

FO-58/FO-59
180 mm

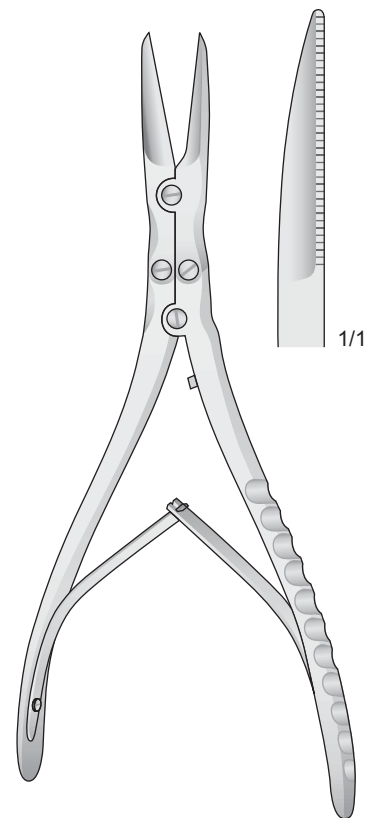

FO-146
215 mm

13

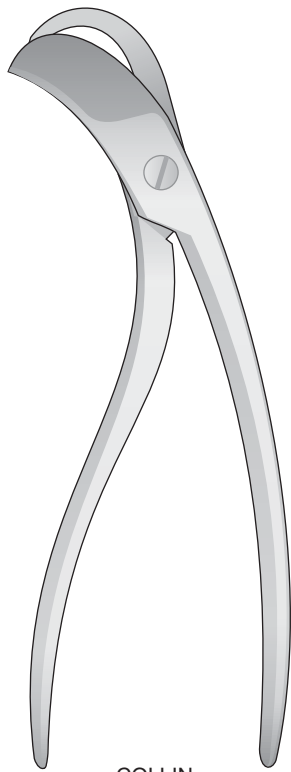

**COLLIN
LX-112**
195 mm

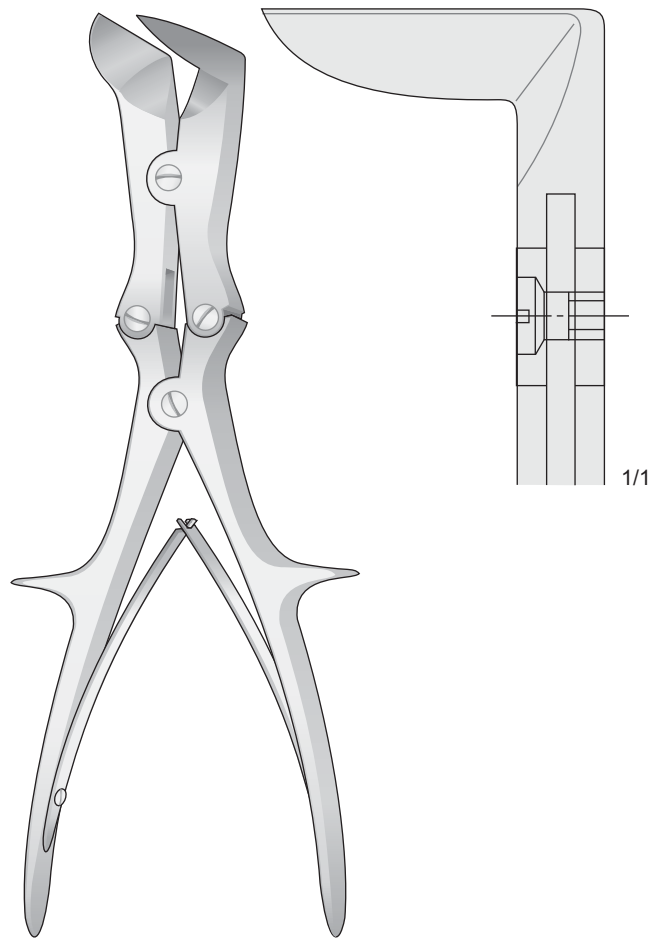

**LISTON-STILLE
FO-158**
265 mm

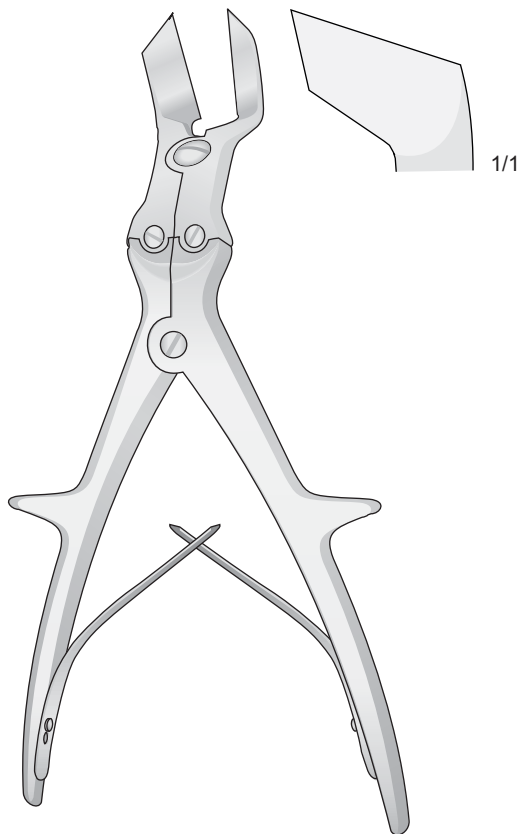

**KEY-HORSLEY
FO-40**
235 mm

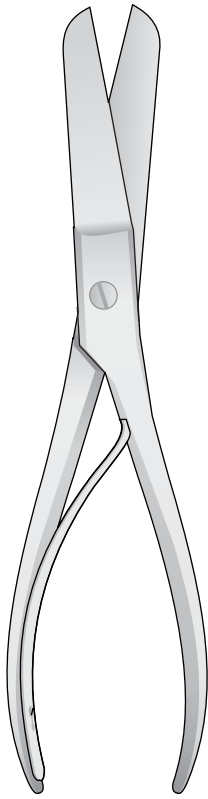

FG-40
230 mm

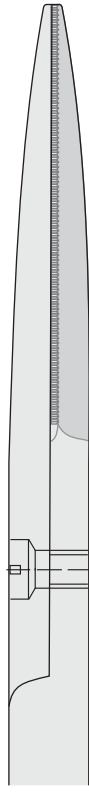

1/1

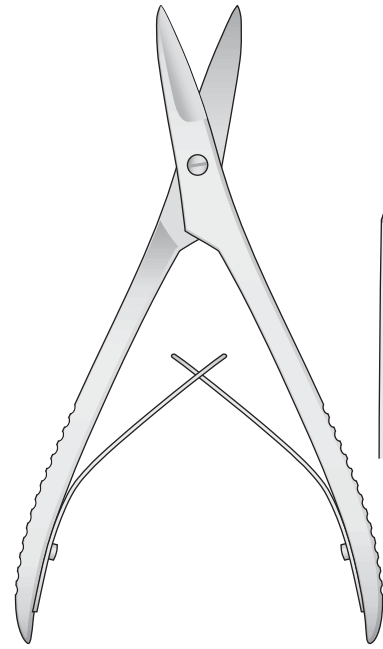

FO-63
160 mm



1/1

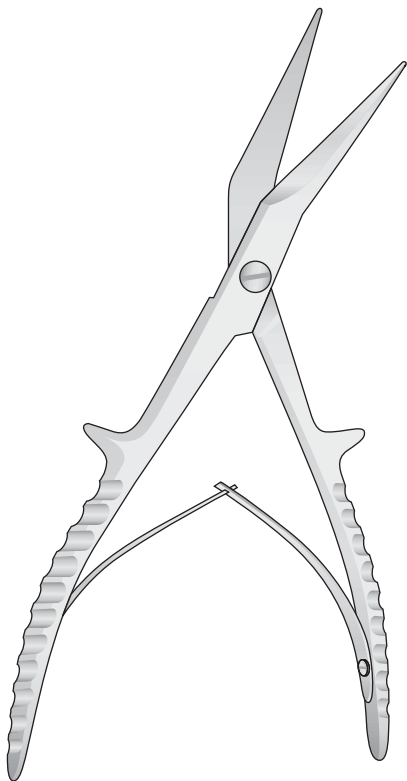

FG-110
195 mm

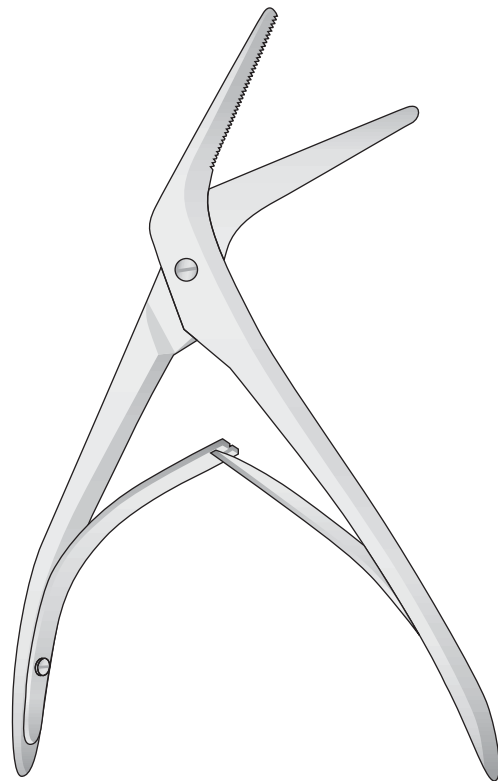

JACKSON-TESSIER
FG-111
190 mm

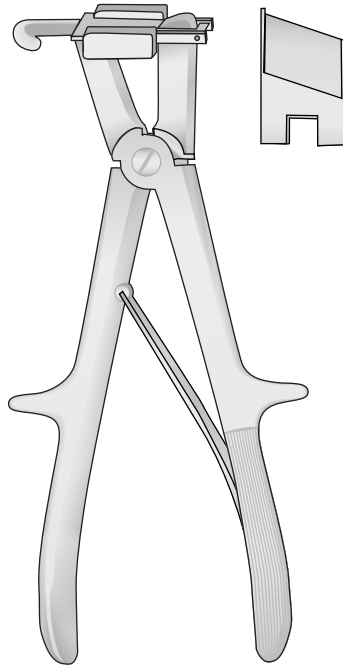

SAUERBRUCH
LX-164 - 230 mm
LX-165 - 260 mm

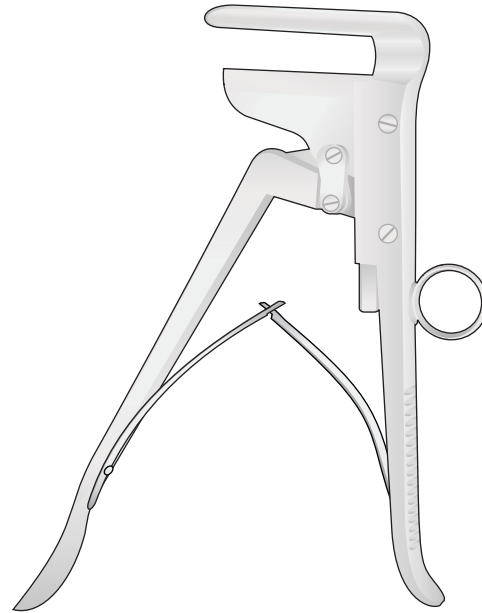

SCHUMACHER
LX-166
210 mm

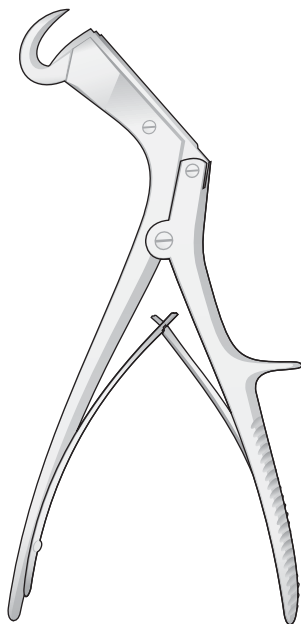

GIERTZ-STILLE
LX-160
250 mm

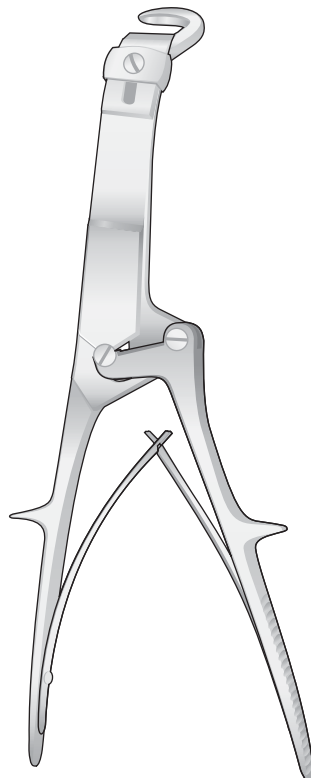

BRUNNER
LX-161 - Destro
LX-163 - Sinistro
320 mm

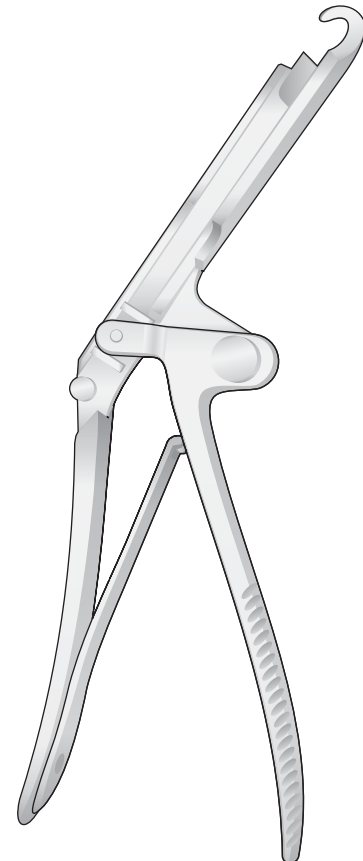

SAUERBRUCH-FREY
LX-162
370 mm

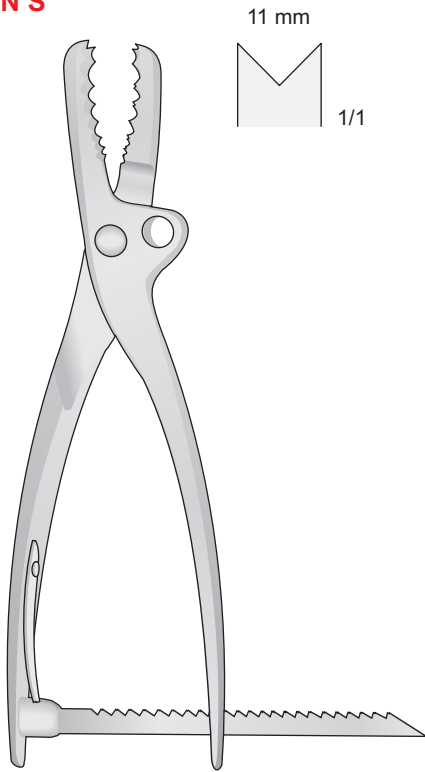

FARABEUF-LAMBOTTE
FO-52
250 mm

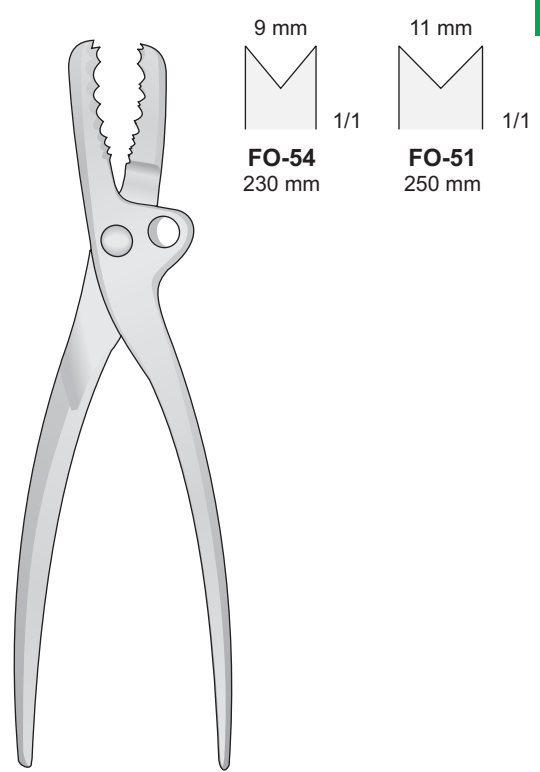

FARABEUF
FO-51/FO-54

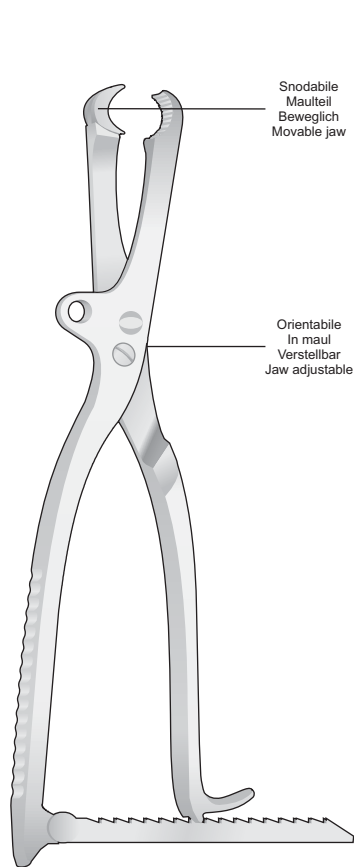

LAMBOTTE
FO-44
265 mm

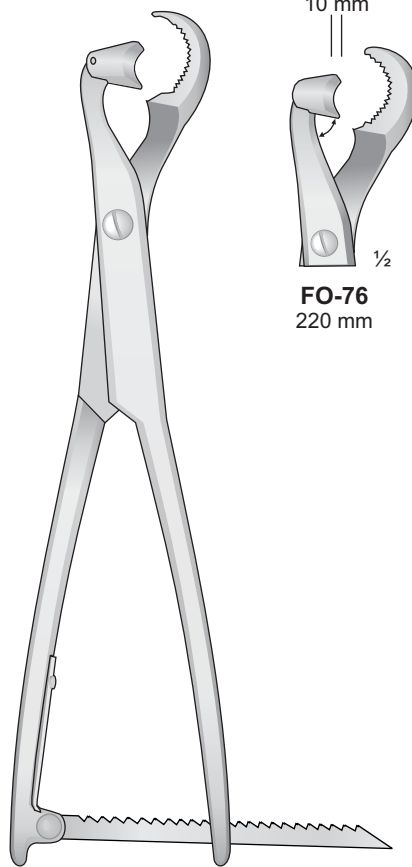

LAMBOTTE
FO-50/FO-53
330 mm

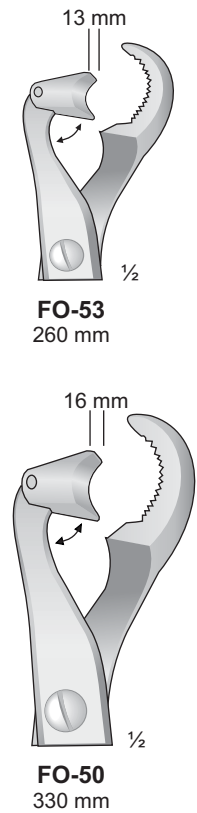

FO-76
220 mm

FO-53
260 mm

FO-50
330 mm

13

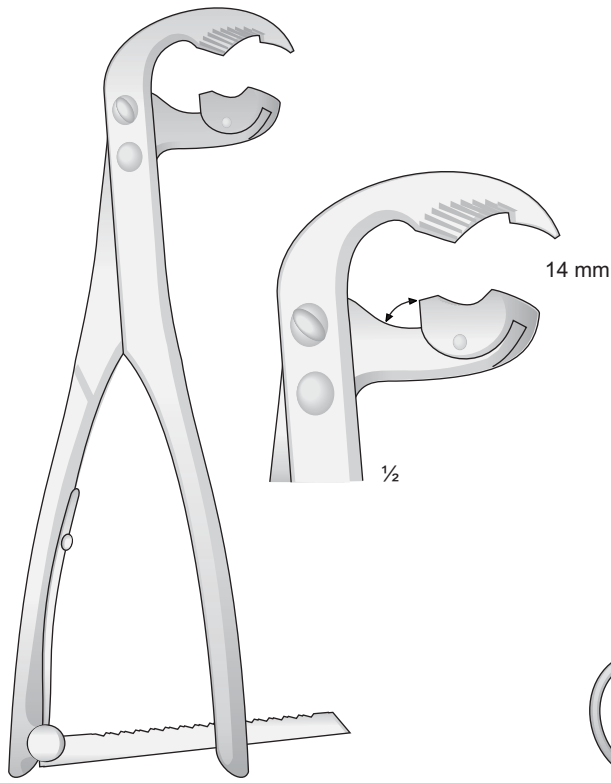

FO-78
215 mm

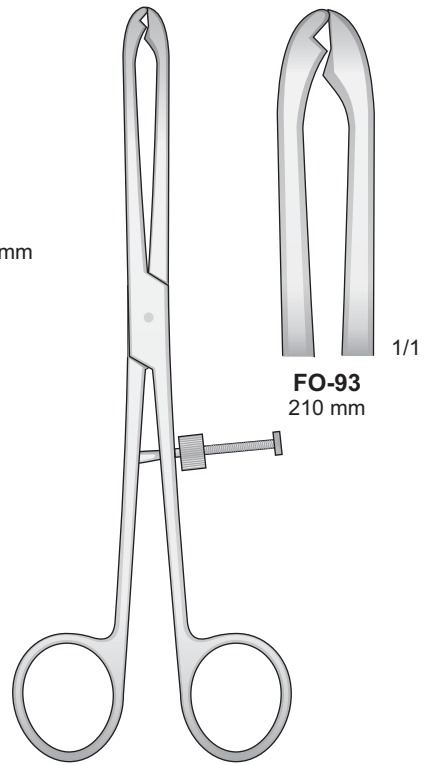

FIBULA
FO-93/FO-94
210 mm

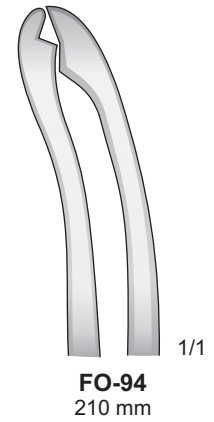

FO-94
210 mm

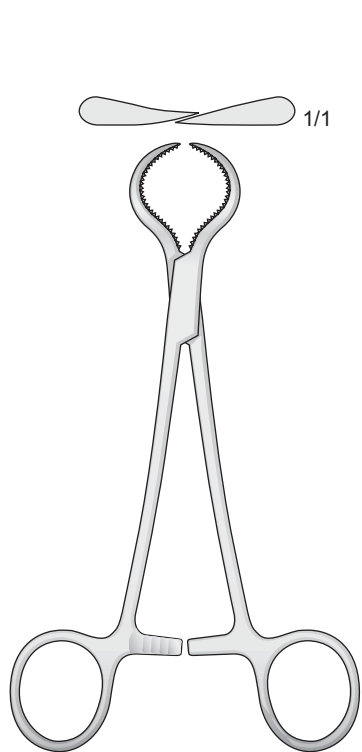

LEWIN
FO-69
180 mm

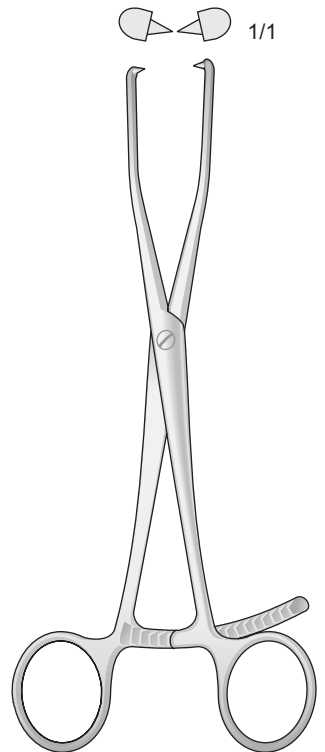

FO-67
210 mm

Pinze riposizionatrici di osso - Repositionszangen
 Reposition forceps - Pinzas para la reducci3n de dedos

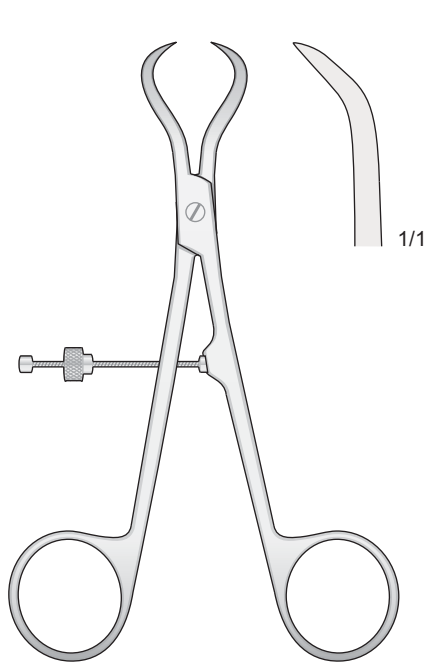

FO-79
140 mm

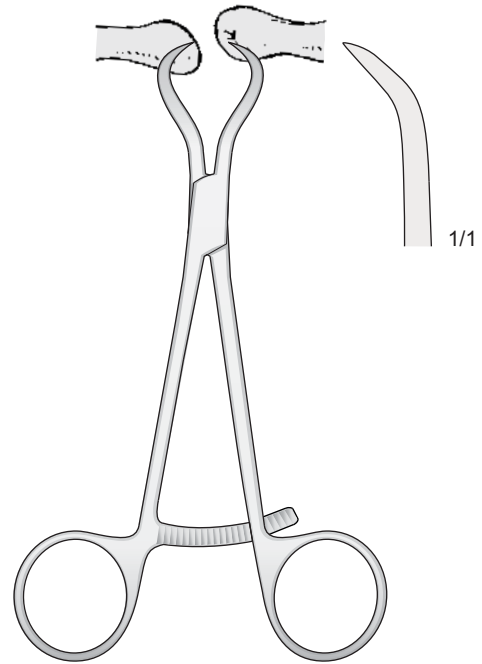

FO-66
135 mm

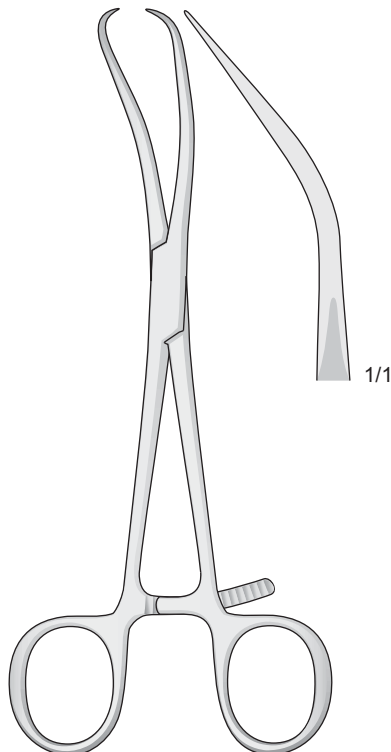

REILL
FO-64
170 mm

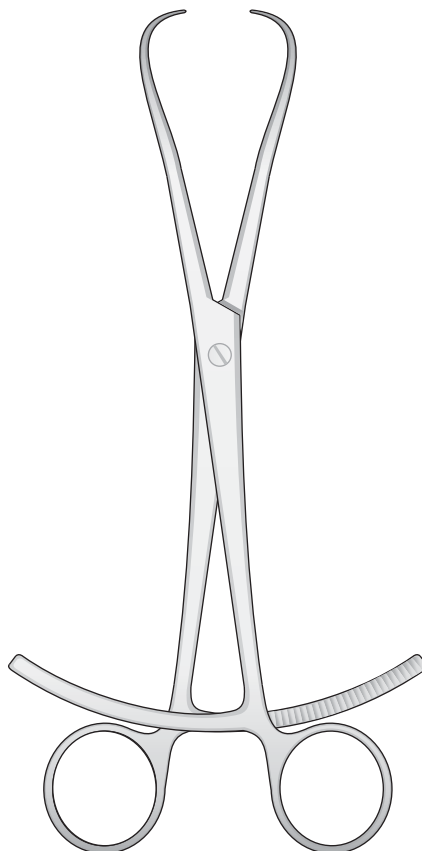

FO-68
200 mm

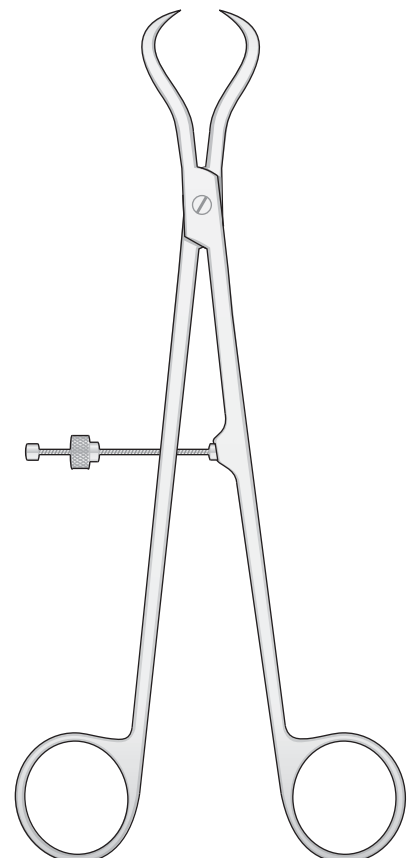

FO-81
210 mm

13

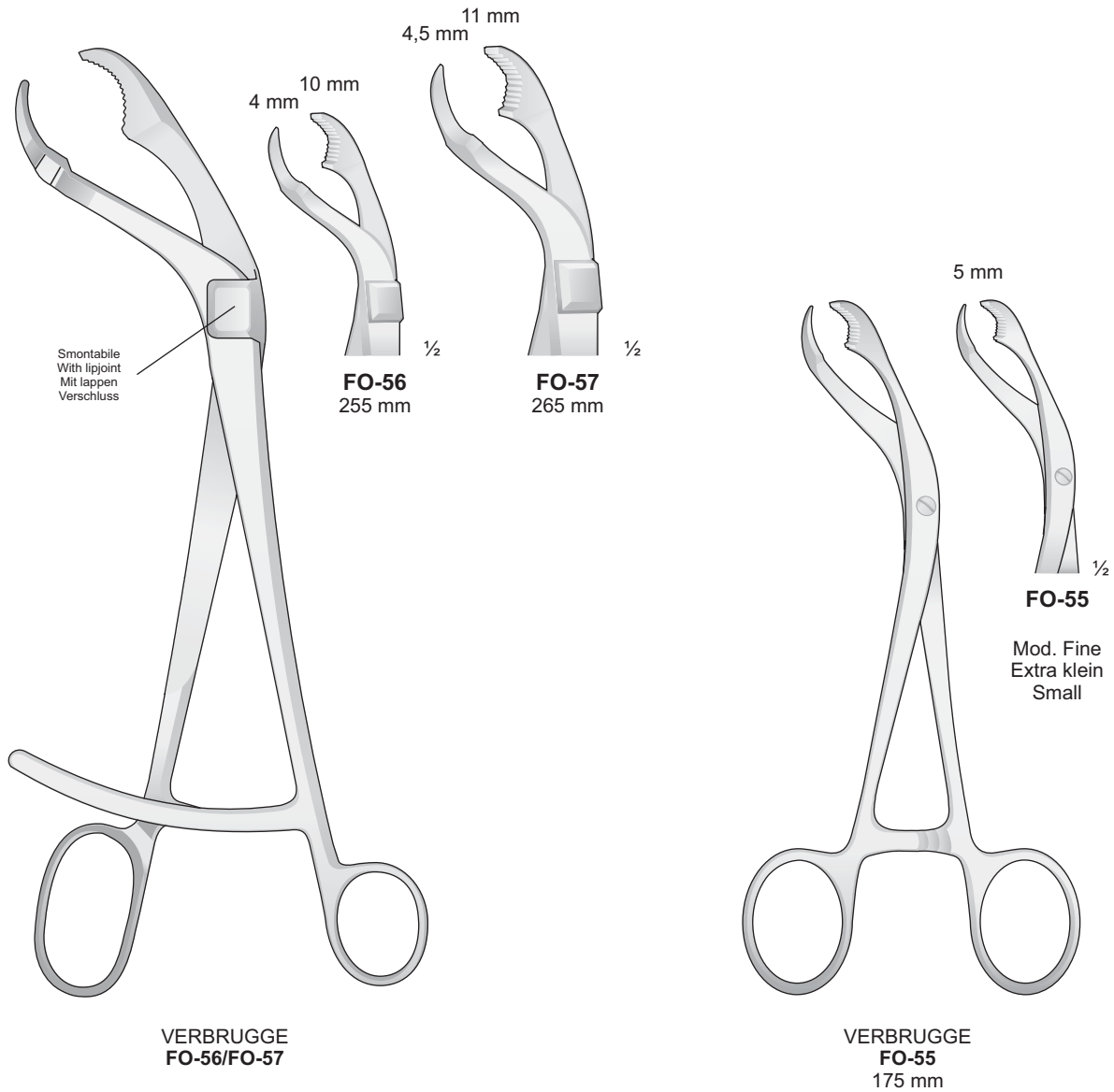

Autocentrante con blocco
Selbstzentrierend mit gewindesperre
Self-centering bone holding forceps with thread lock

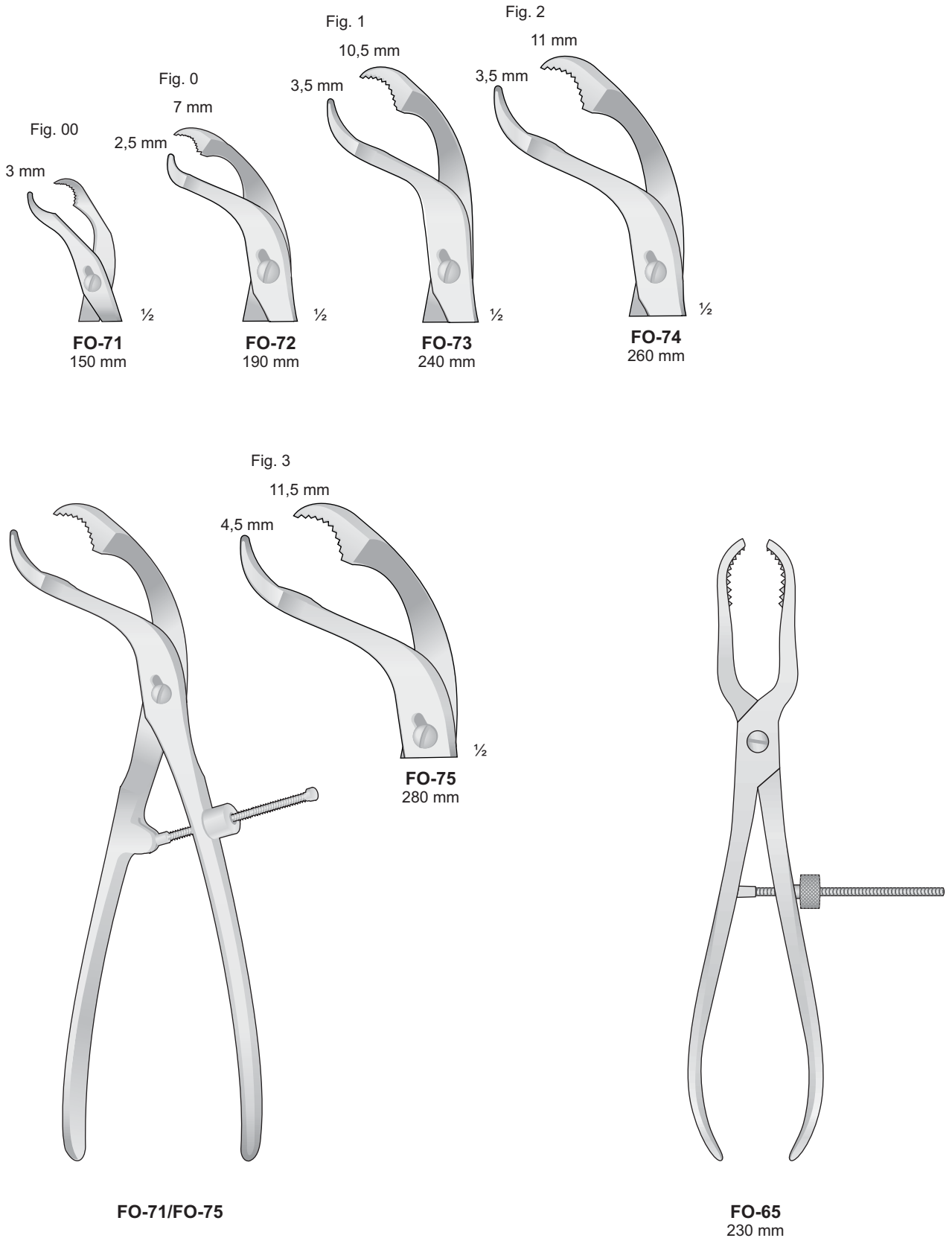

13

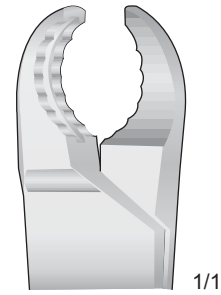

FO-62
230 mm

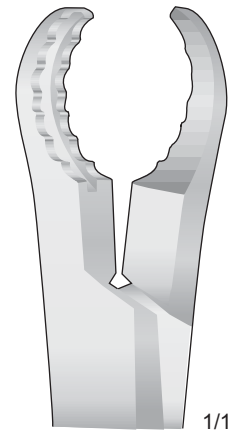

FO-82
250 mm

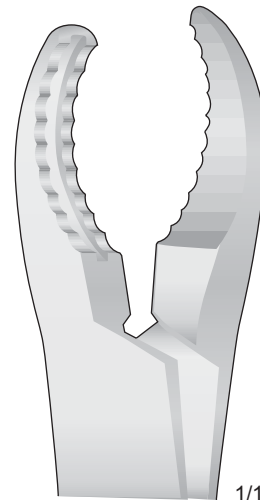

FO-105
280 mm

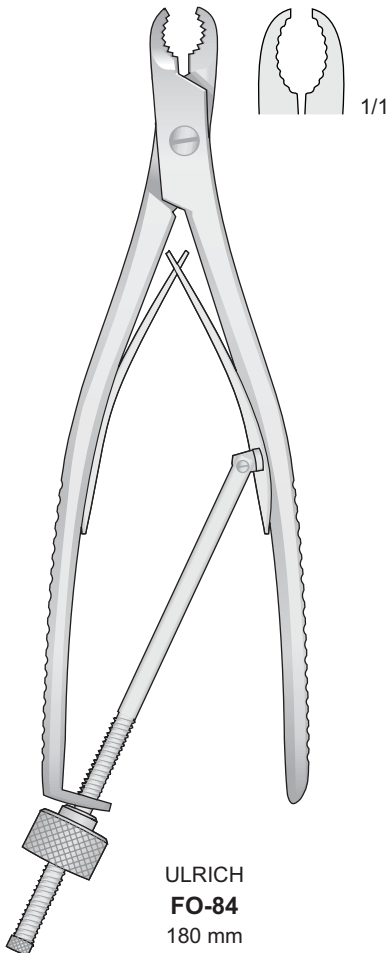

ULRICH
FO-84
180 mm

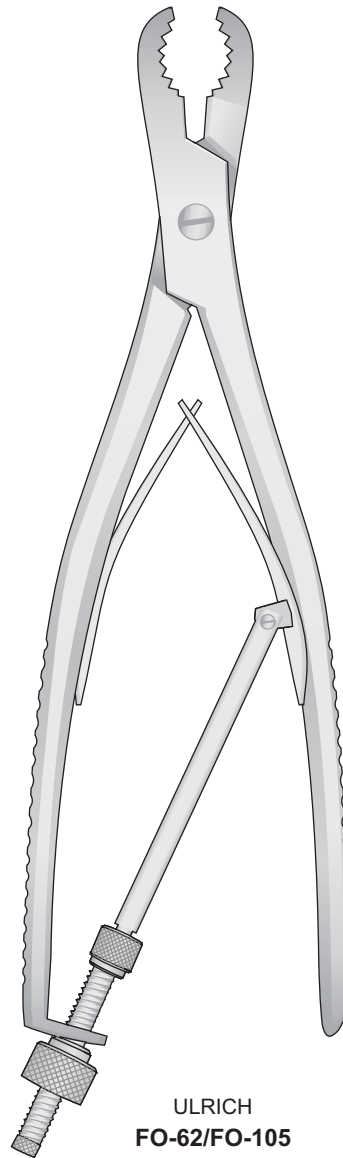

ULRICH
FO-62/FO-105
260 mm

Pinza per cartilagine

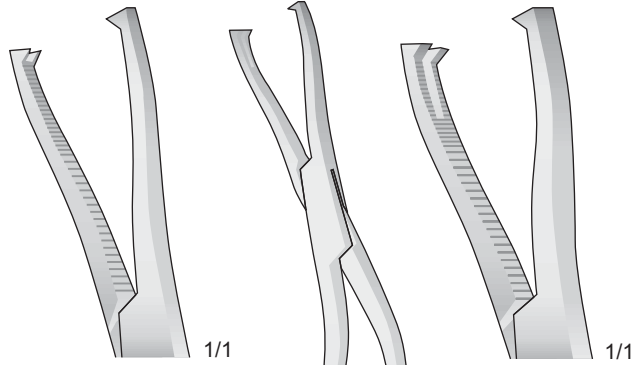

DINGMANN
FO-130

DINGMANN MODIF.
FO-131

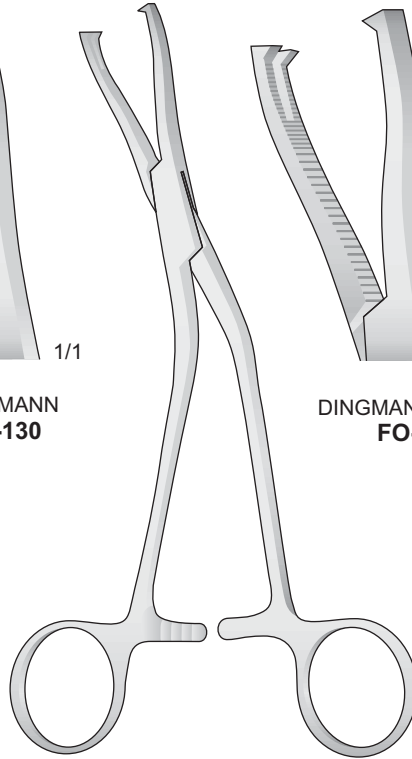

DINGMANN
FO-130/FO-131
190 mm

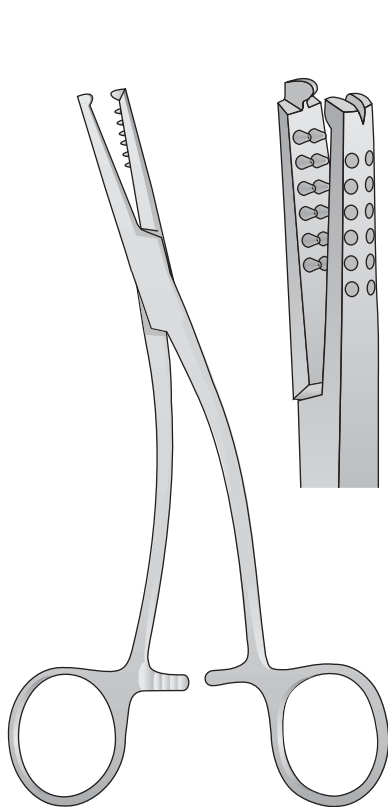

FO-134
185 mm

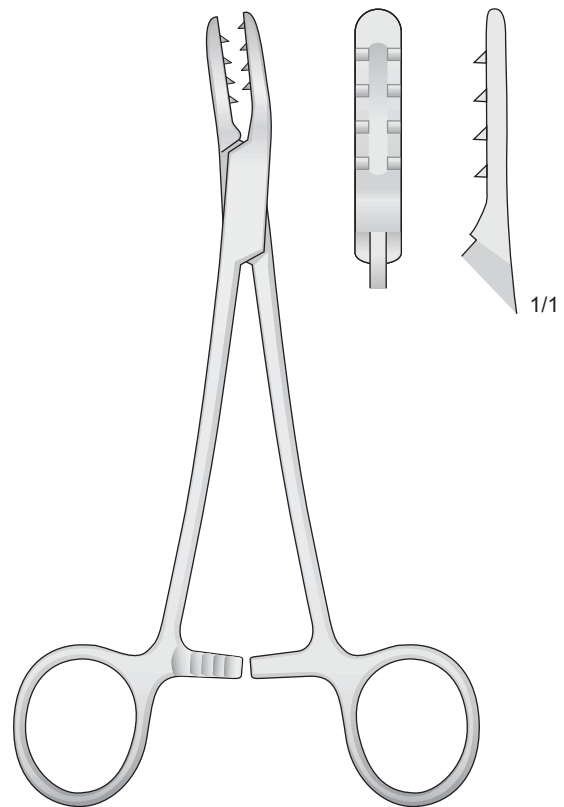

MARTIN
FO-133
200 mm

13

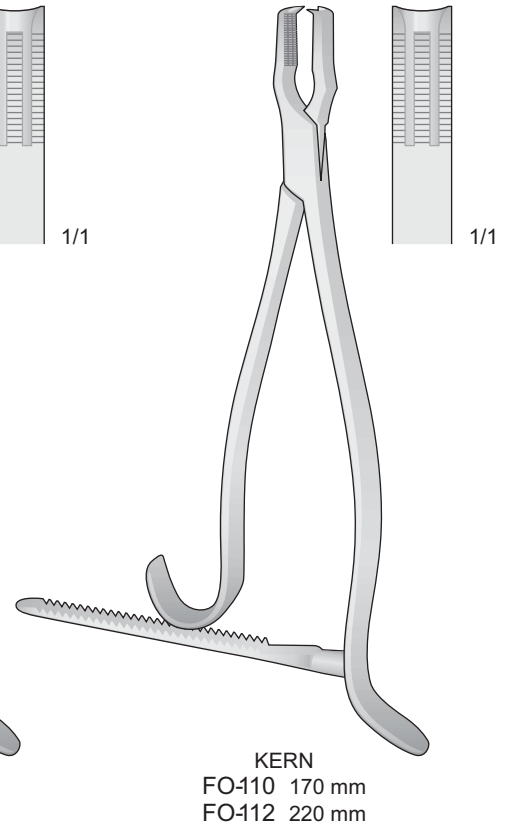
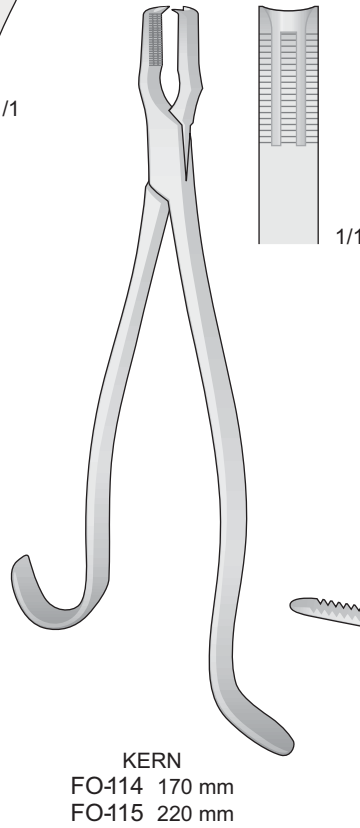
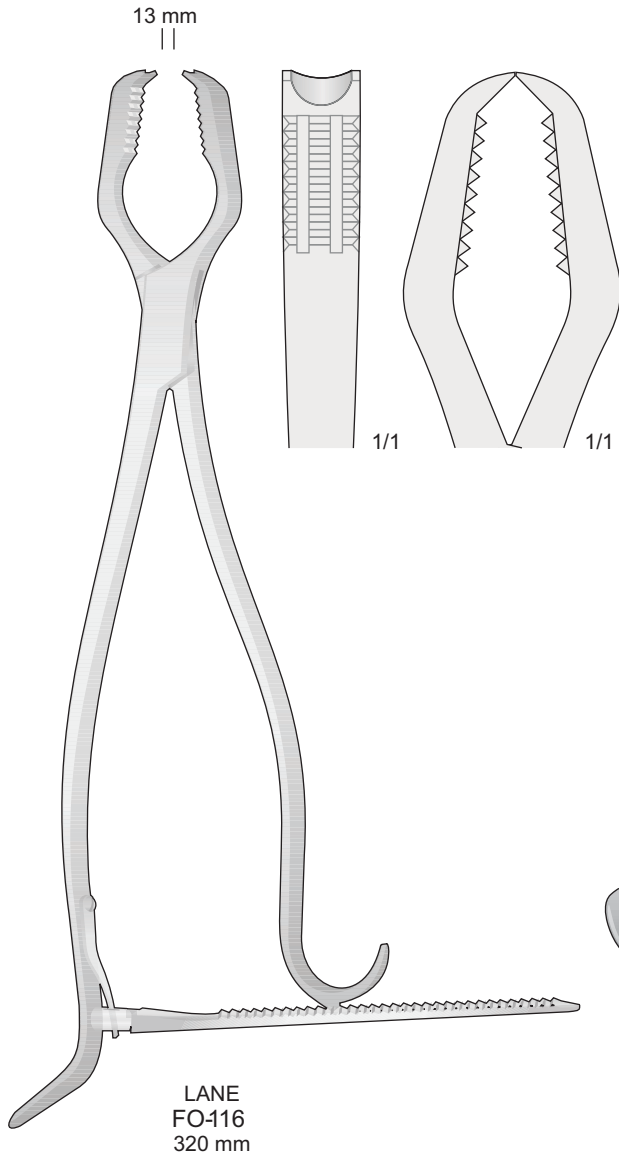

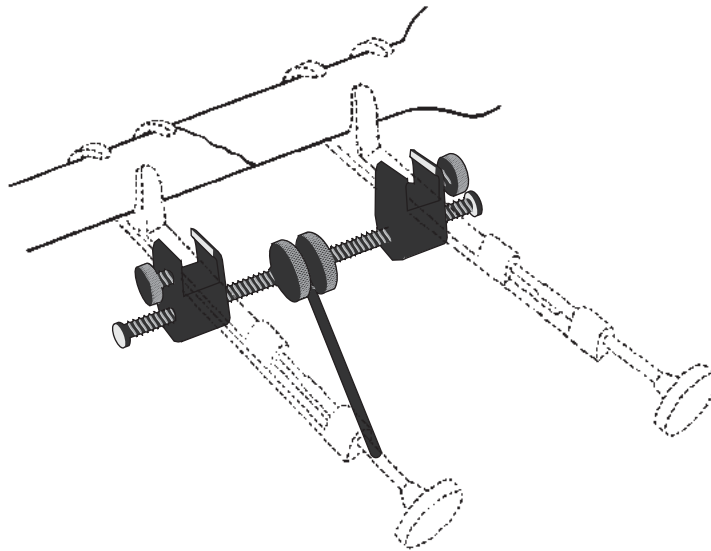

GERSTER
FO-96

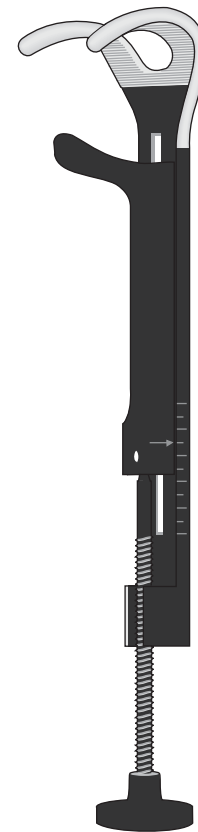

GERSTER-LOWMAN
FO-90 120 mm
FO-91 185 mm
FO-92 200 mm

Per bambini
For children
Für Kinder
Pour enfants
Para niños

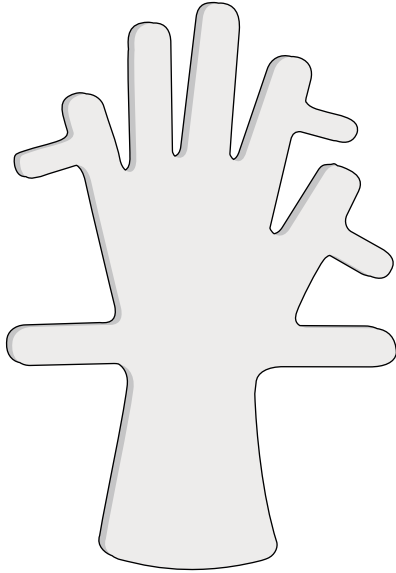

FO-299

Per adulti - For adults - Für Erwachsene
Pour adultes - Para adultos

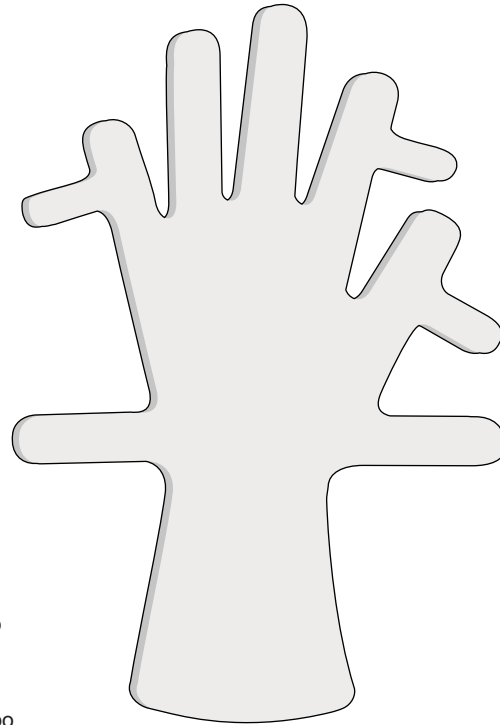

FO-300

Mani di piombo
Lead hands
Bleihände
Main de plomb
Manos de plombo

Pinza taglia anelli - Forceps for opening rings
Fingerringssägen - Scies pour bagues - Sierra para anillos

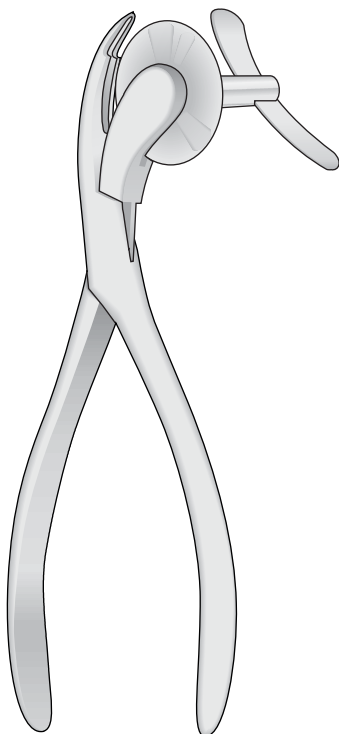

FO-80
170 mm

Pinza per estrazione delle unghie
Nail extracting forceps
Nagel ausreißzange
Pince pour extraire les ongles
Pinzas para arrancar uñas

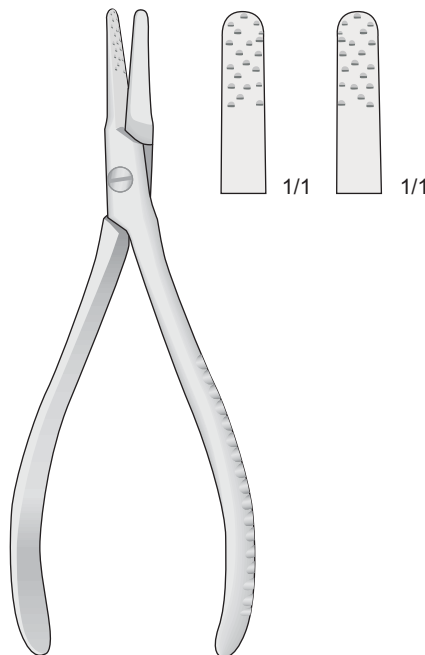

RADOLF
FO-159
135 mm

Pinza per unghie
Nail nipper
Nagelspaltzange
Pince à ongles
Pinzas corta uñas

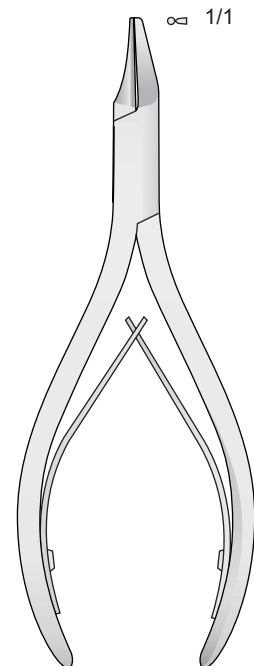

DP-09
135 mm

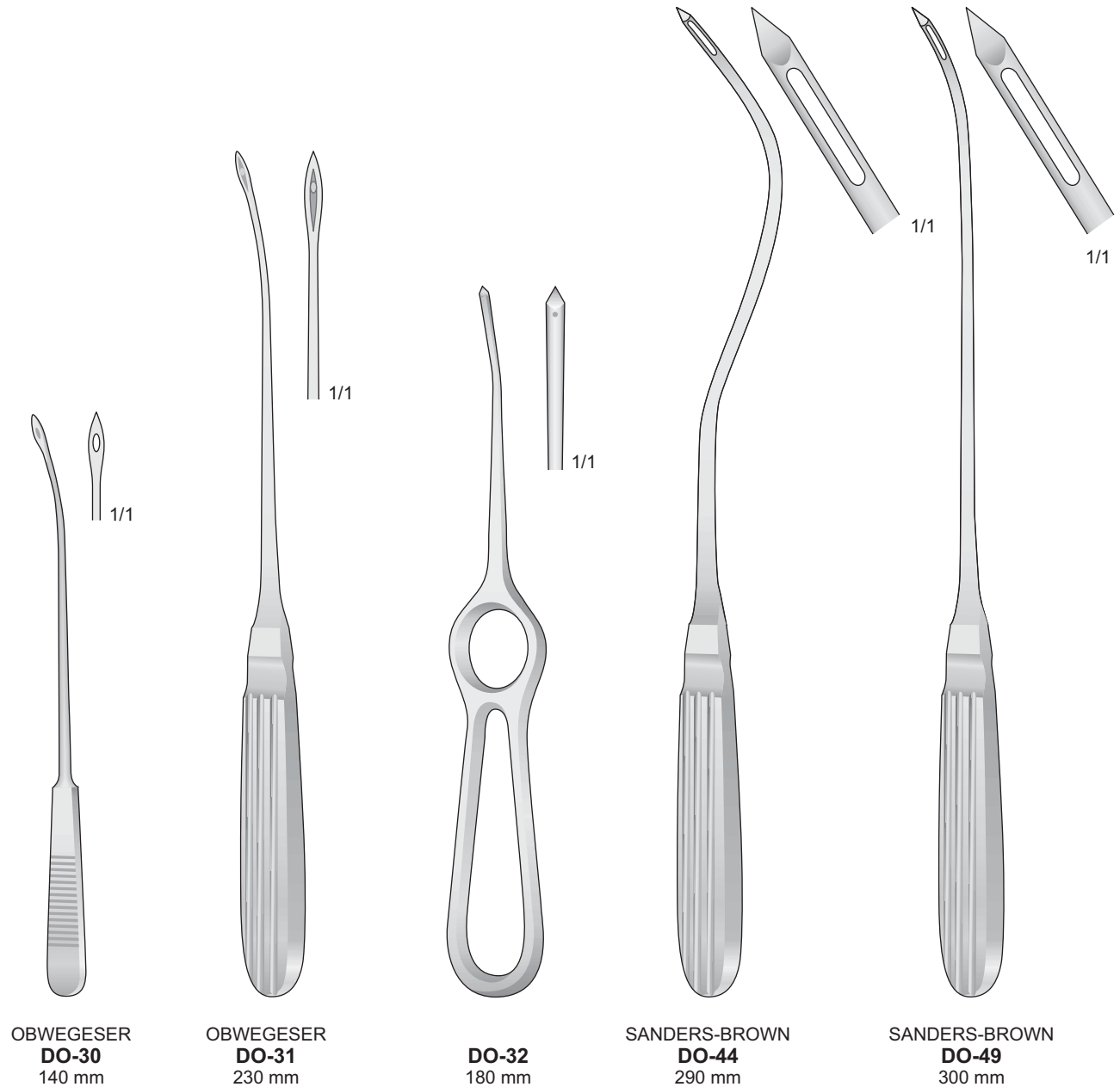

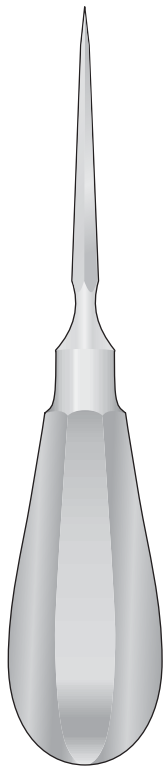

TR-77
140 mm

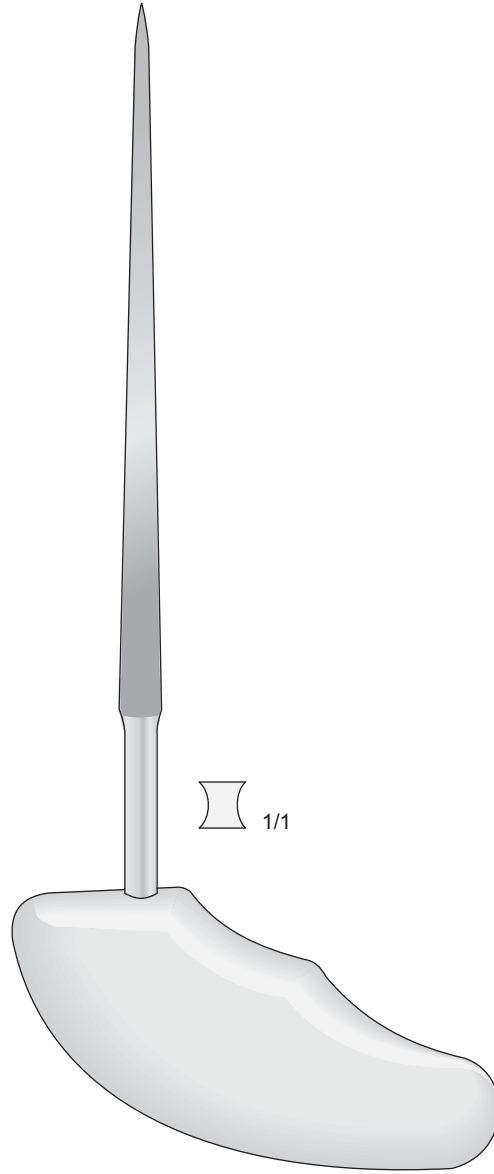
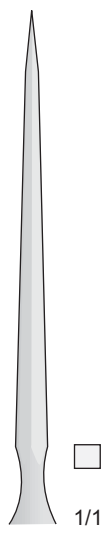

PERTHES
TR-78
210 mm

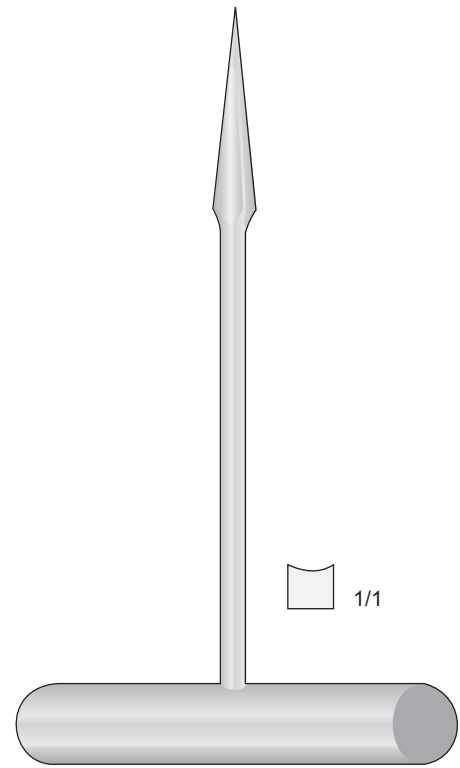

TR-76
140 mm

KIRSCHNER

Bundel-Nagel

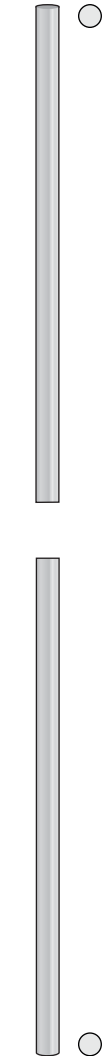

500 mm

Steinmann pins



310 mm

Küntscher

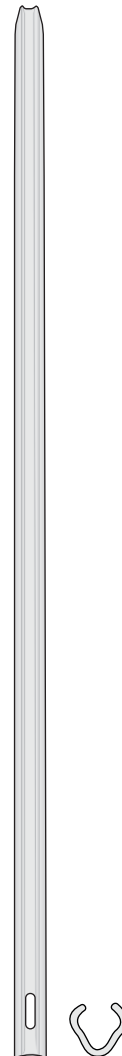

400 mm

Threaded Steinmann Pins

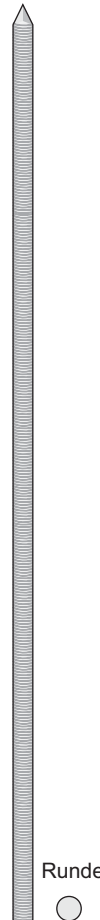

Runde

230 mm

Ø/Diam.	Conf. 10 pz.
2,0 mm	KI-50
2,5 mm	KI-51
3,0 mm	KI-52
3,5 mm	KI-53
4,0 mm	KI-54
4,5 mm	KI-55
5,0 mm	KI-56
5,5 mm	KI-57
6,0 mm	KI-58

Ø/Diam.	Conf. 1 pz.
3,5 mm	KI-280
4,0 mm	KI-282
4,5 mm	KI-284
5,0 mm	KI-286
6,0 mm	KI-288
6,5 mm	KI-290

Ø/Diam.	Conf. 1 pz.
6,0 mm	KI-252
7,0 mm	KI-254
8,0 mm	KI-256
9,0 mm	KI-258
10 mm	KI-260
11 mm	KI-262
12 mm	KI-264

Ø/Diam.	Conf. 1 pz.
2,0 mm	KI-160
2,5 mm	KI-161

Strumenti per filo di cerchiaggio
 Wire instrument set
 Drahtinstrumentarium
 Instruments à fil
 Instrumental para cerclaje

Filo malleabile
 per compattare l'osso
 Wire soft
 Draht weich
 Fil à os
 Alambre ligadura



10 mt.

Ø/Diam.	Codice
0,2 mm	KI-202
0,3 mm	KI-203
0,4 mm	KI-204
0,5 mm	KI-205
0,6 mm	KI-206
0,7 mm	KI-207
0,8 mm	KI-208
0,9 mm	KI-209
1,0 mm	KI-210
1,2 mm	KI-211
1,5 mm	KI-212

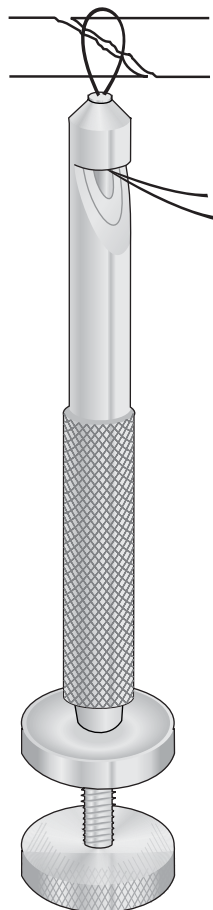

LOUTE
KI-322
 220 mm

Strumenti tendifili
 Bone wire tighteners
 Drahtspanninstrument
 Tendeur serre fils
 Tensor cierra-hilos

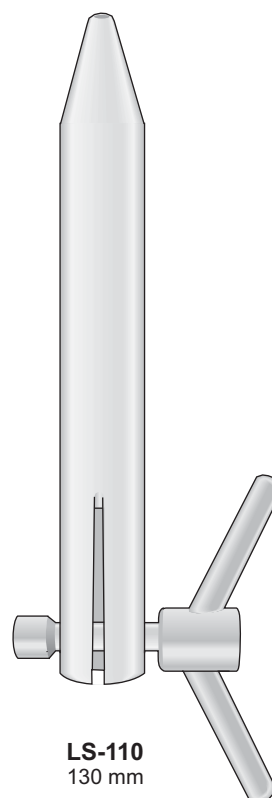

LS-110
 130 mm

Fino a Ø 3 mm
Bis Ø 3 mm
Up to Ø 3 mm

Gancio d'estrazione
Extraction hooks
Extraktions haken
Crochets d'extraction
Ganchos extractores

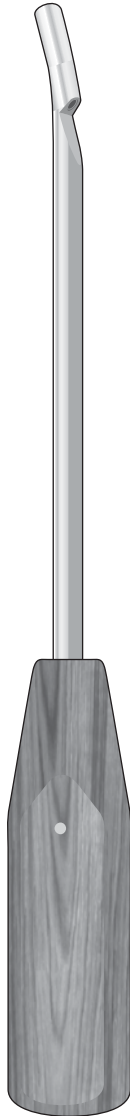

WAGNER
LS-106
300 mm

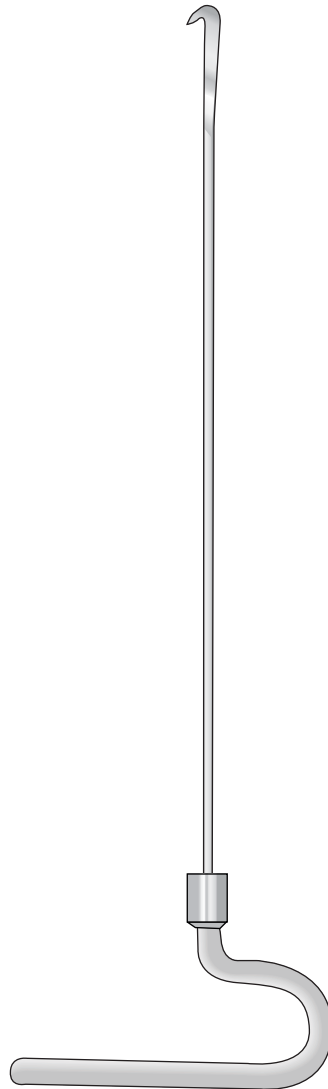

KI-306 - 290 mm
KI-307 - 370 mm
KI-308 - 420 mm



LS-100
120 mm

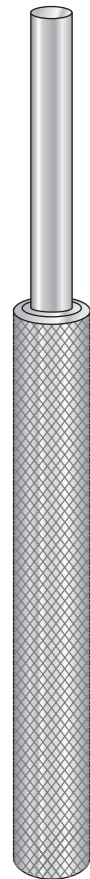

KÜNTSCHNER
FK-09
210 mm

13

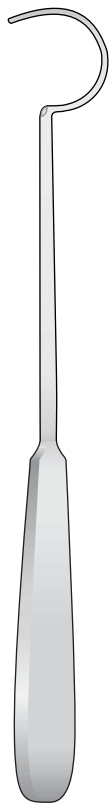

DEMEL
BM-12/BM-14

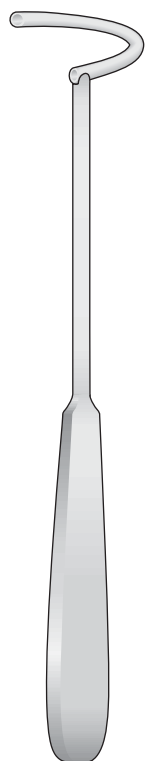
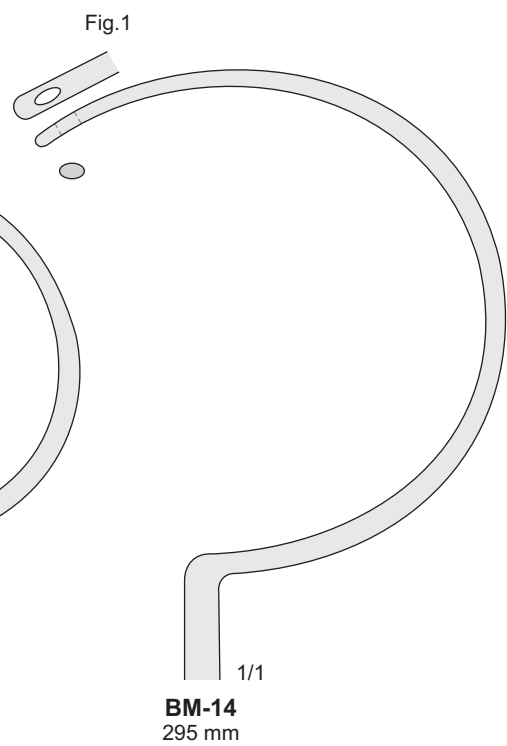
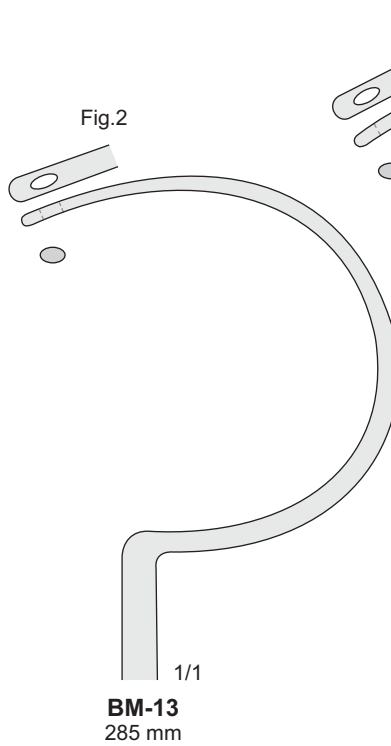
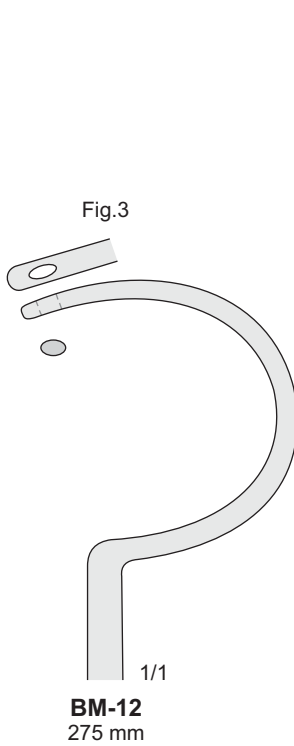

BM-10
225 mm

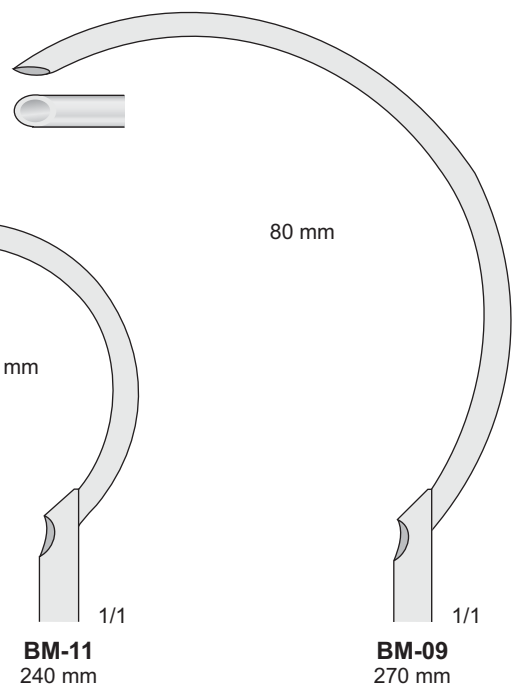
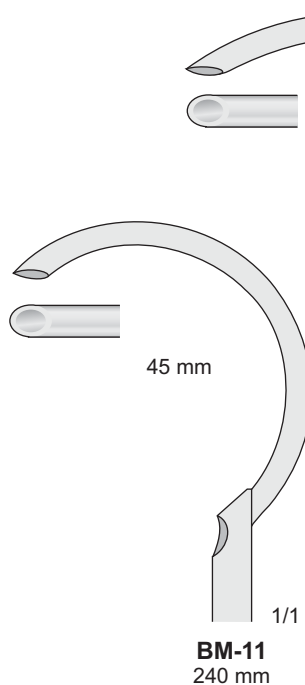
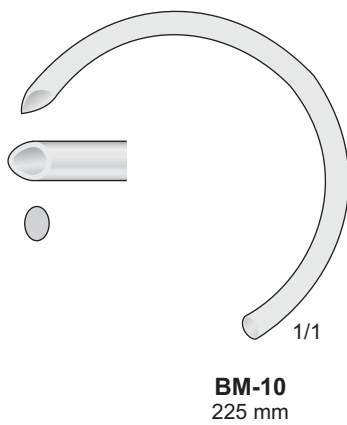

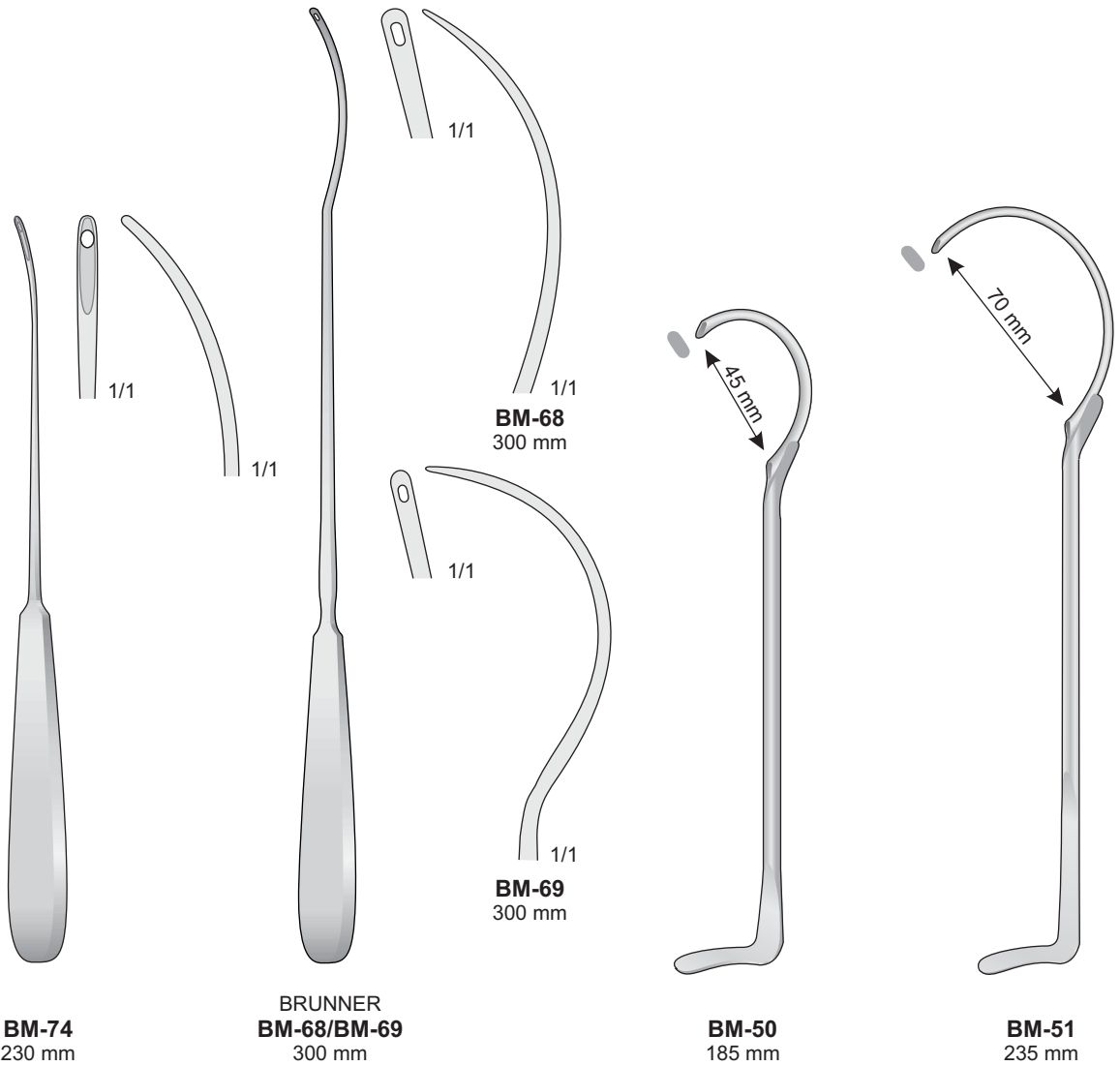

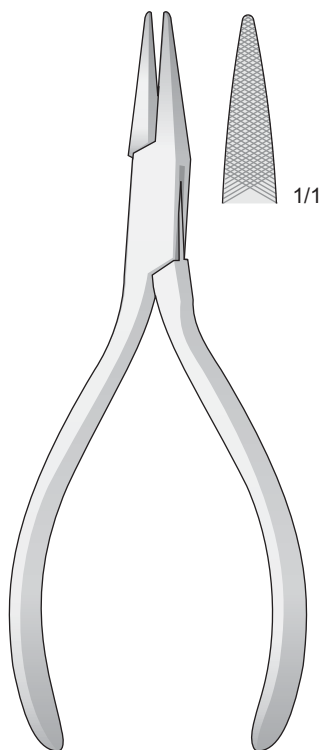

DP-08
140 mm

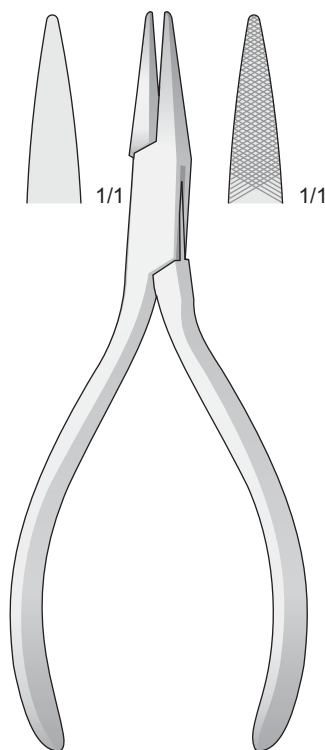

DP-18
140 mm

Per filo duro \varnothing 1 mm
For hard wire \varnothing 1 mm
Für harten draht \varnothing 1 mm
Pour fil dur \varnothing 1 mm
Para alambres duro \varnothing 1 mm

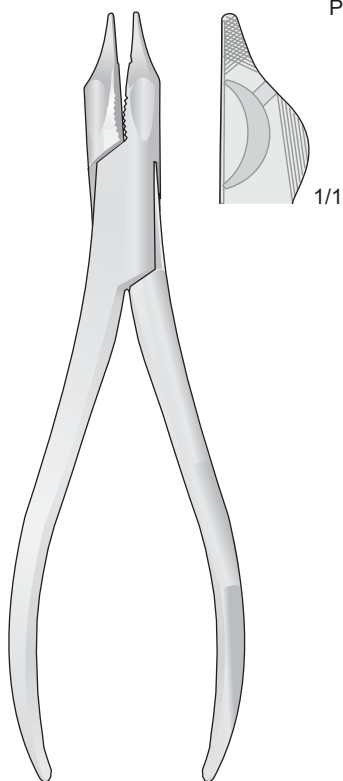

DP-71
150 mm

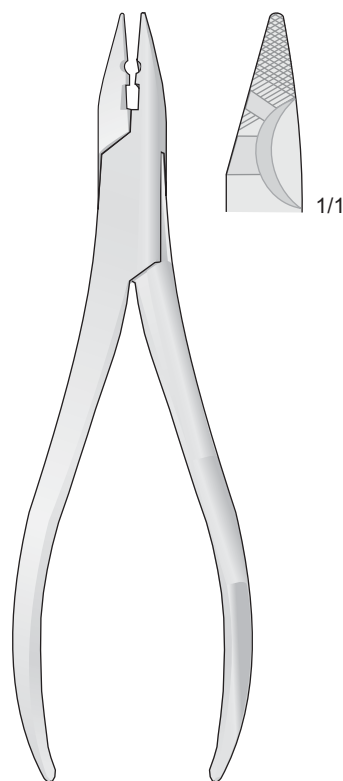

DP-75
160 mm

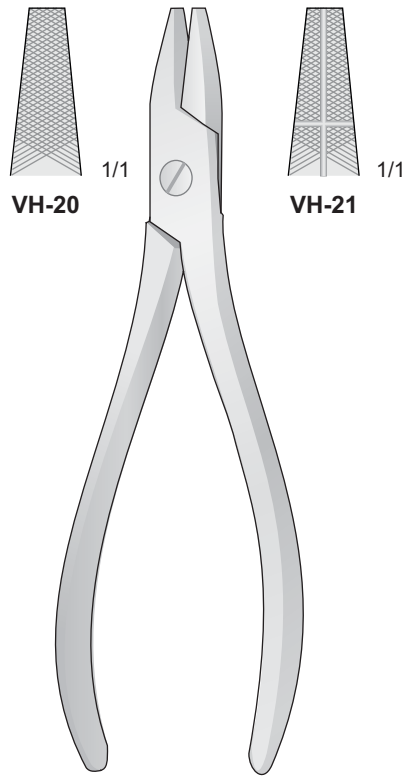

VH-20

VH-21

VH-20/VH-21
175 mm

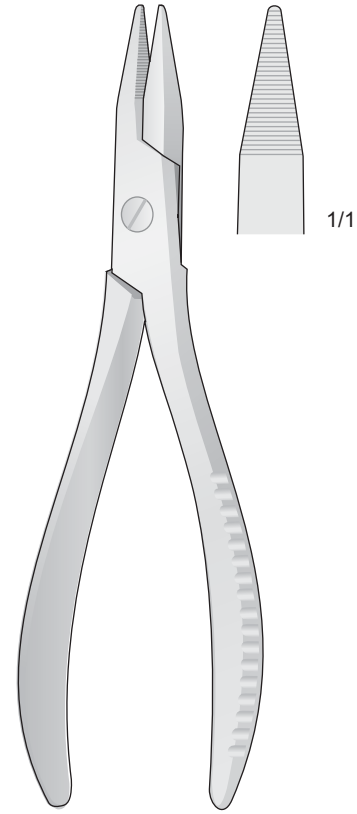

VH-23
190 mm

Pinza per estrazione
fili metallici
Flachzangen für draht

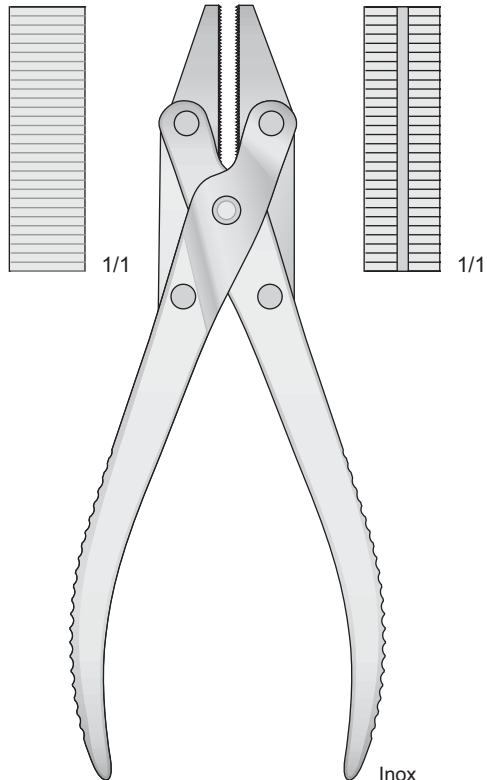

VH-25
185 mm

Inox

Pinza a branche parallele
con tronchese

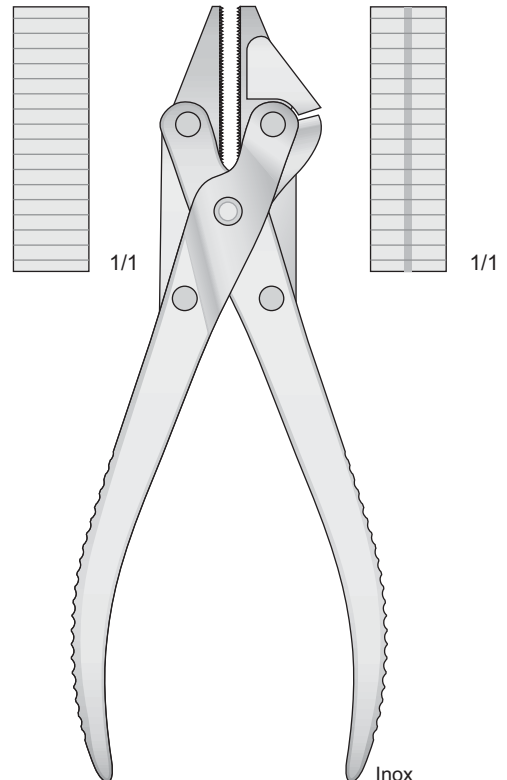

LX-80
185 mm

Inox

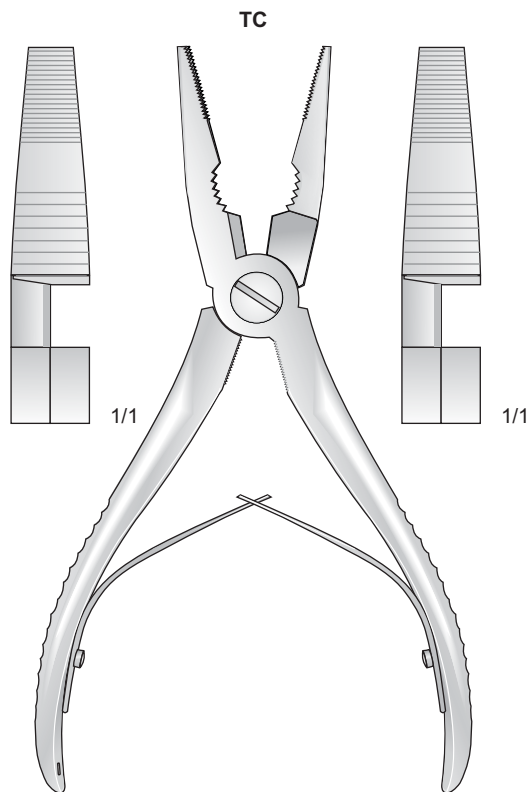
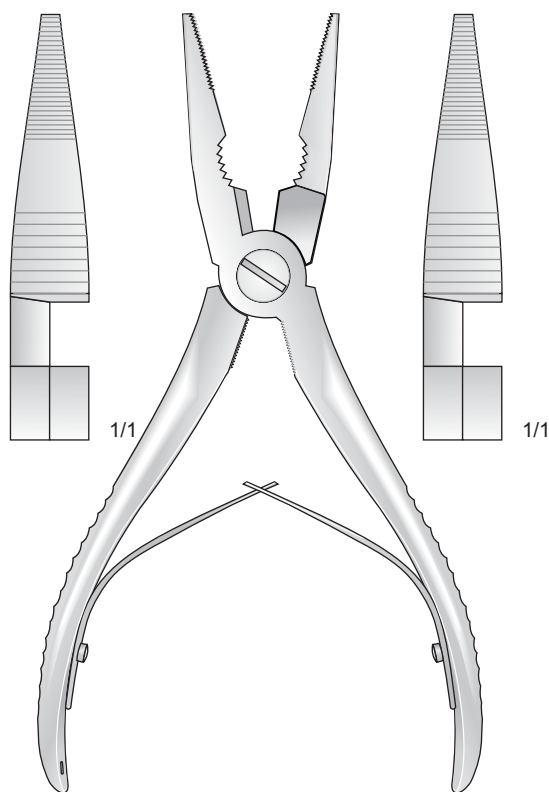

LX-135
175 mm

LX-136
165 mm

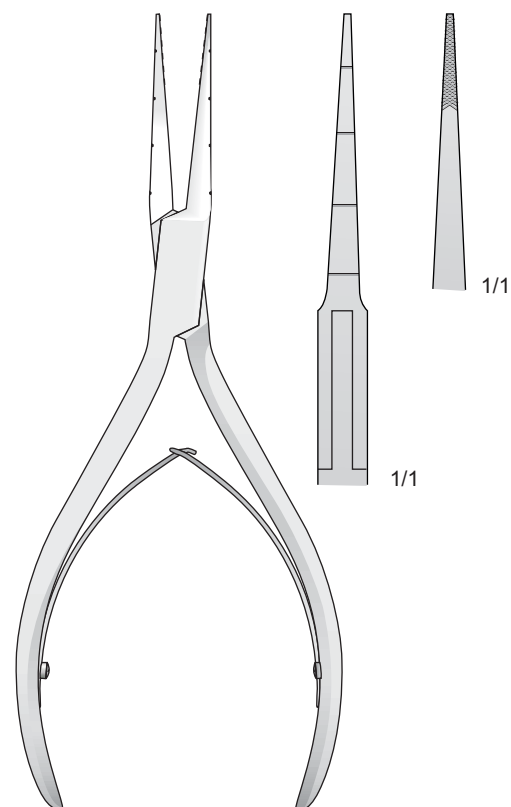
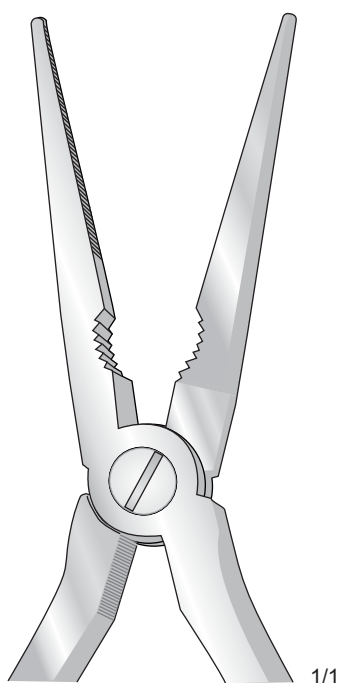
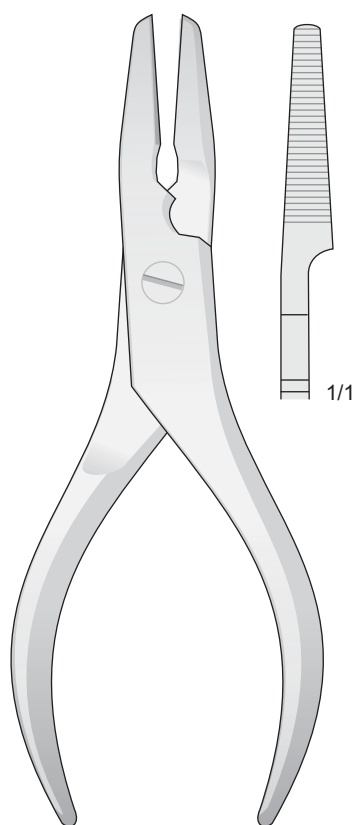

LX-137
200 mm

LX-134
160 mm

DP-96
150 mm

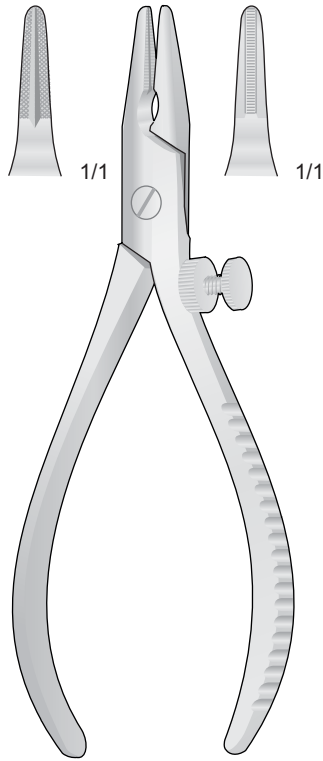

LX-130
140 mm

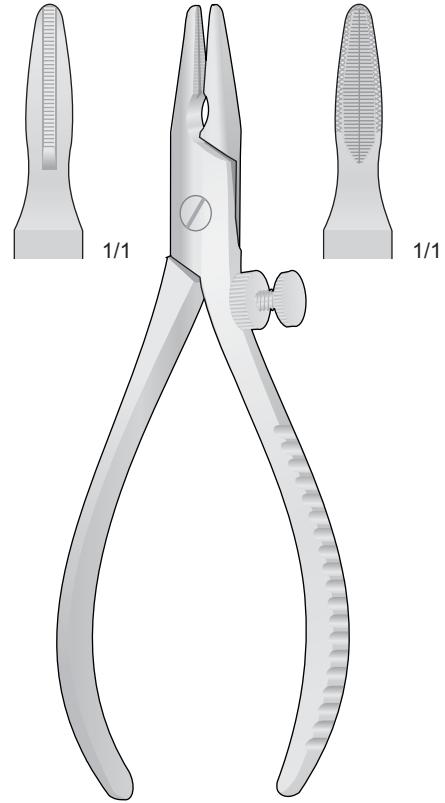

LX-131
180 mm

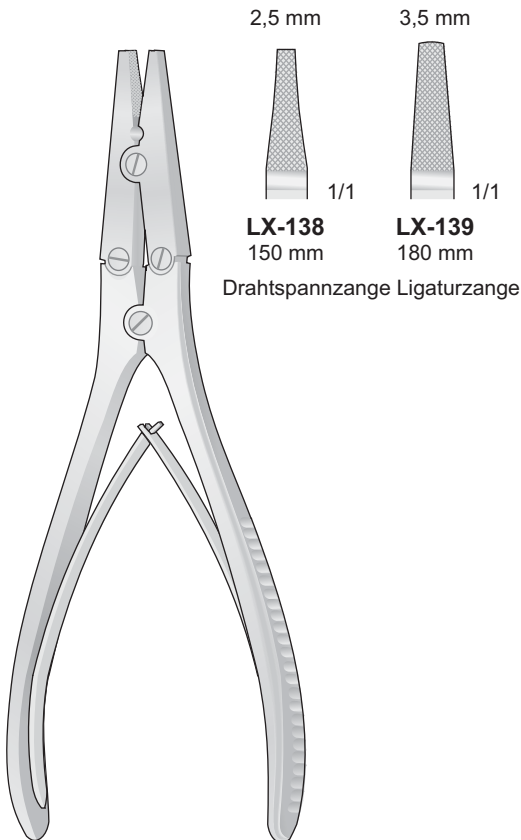

LX-138
150 mm

LX-139
180 mm

Drahtspannzange Ligaturzange

LX-138/LX-139

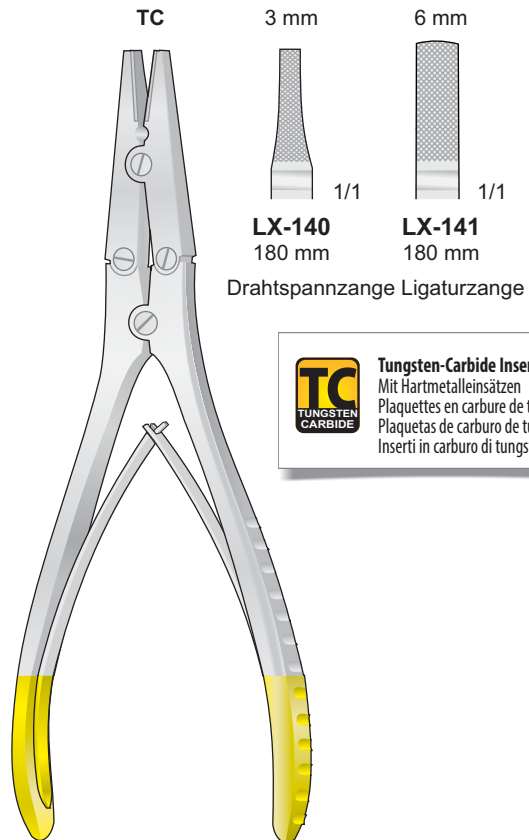

LX-140
180 mm

LX-141
180 mm

Drahtspannzange Ligaturzange

LX-140/LX-141

TC
TUNGSTEN
CARBIDE
Tungsten-Carbide Inserts
Mit Hartmetalleinsätzen
Plaquettes en carbure de tungstène
Plaquetas de carburo de tungsteno
Inserti in carburo di tungsteno

Per fili duri di \varnothing 0,4 mm - For hard wire with \varnothing 0,4 mm
 Für harten Draht bis \varnothing 0,4 mm - Pour fils durs avec \varnothing 0,4 mm
 Para hilos duros de \varnothing 0,4 mm

Per filo duro \varnothing 1 mm - Für harten draht \varnothing 1 mm
 For hard wire \varnothing 1 mm - Pour fil dur avec \varnothing 1 mm
 Para alambres duro \varnothing 1 mm

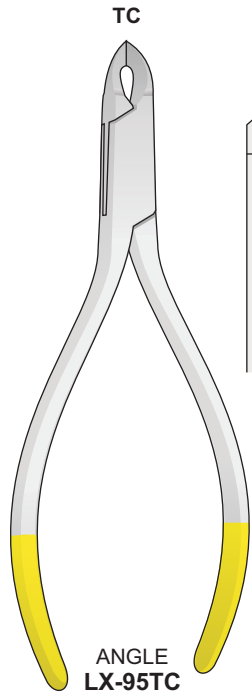

ANGLE
LX-95TC
 130 mm

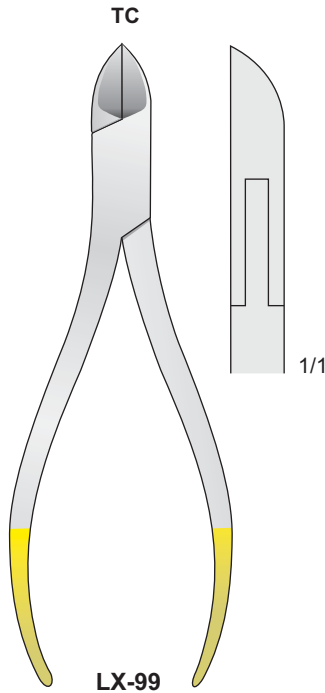

LX-99
 130 mm

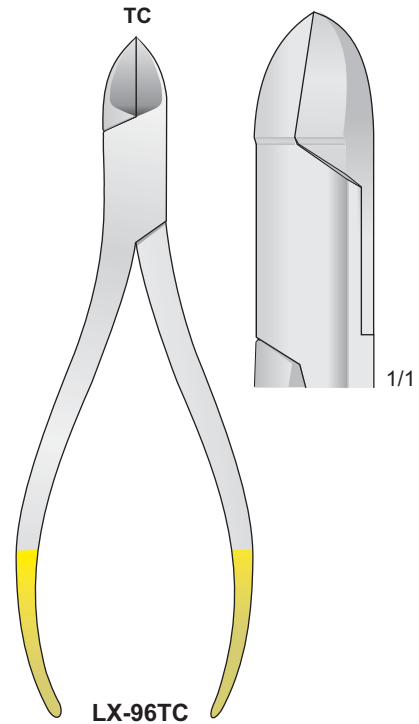

LX-96TC
 150 mm

Per filo duro \varnothing 1 mm - Für harten draht \varnothing 1 mm
 For hard wire \varnothing 1 mm - Pour fil dur avec \varnothing 1 mm
 Para alambres duro \varnothing 1 mm

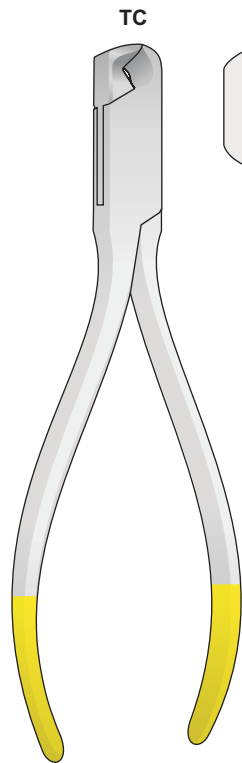

LX-92TC
 145 mm

1/1

Tungsten-Carbide Inserts
 Mit Hartmetalleinsätzen
 Plaquettes en carbure de tungstène
 Plaquetas de carburo de tungsteno
 Inserti in carburo di tungsteno



LX-82
 185 mm

Port'aghi, pinze per fili d'acciaio
Needle holders, wire forceps
Nadelhalter, Draht-zangen
Porte aiguilles, pinces à saisir
Porta agujas, pinzas para hilos

TC

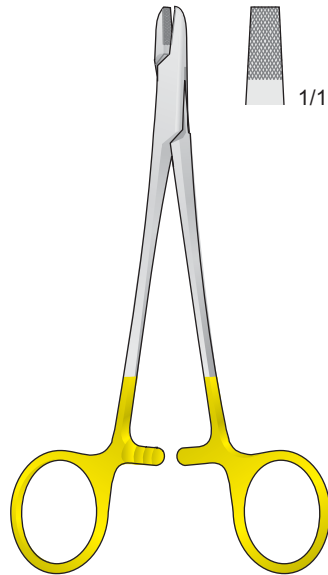

PH-58
150 mm



Tungsten-Carbide Inserts
Mit Hartmetalleinsätzen
Plaquettes en carbure de tungstène
Plaquetas de carburo de tungsteno
Inserti in carburo di tungsteno

TC

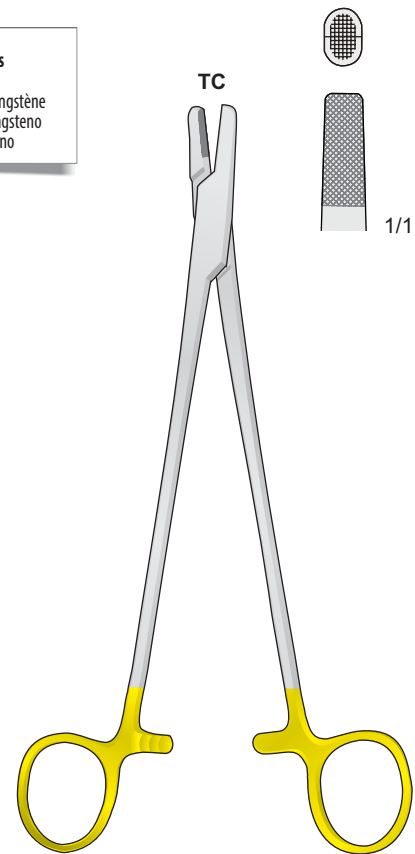

BAUMGARTNER
PH-57
200 mm

TC

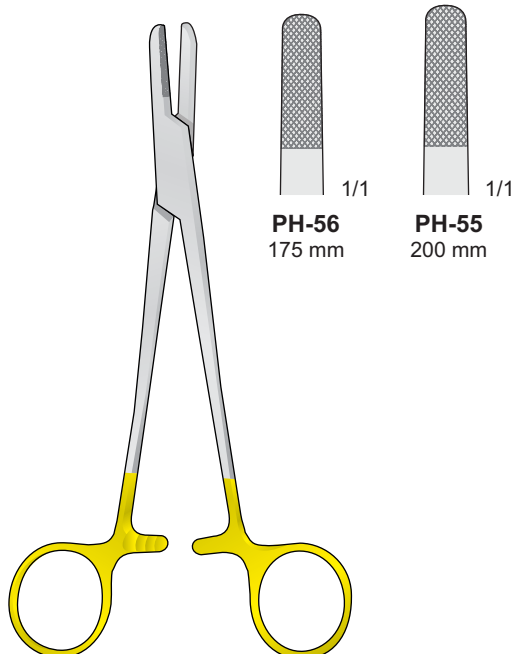

PH-56
175 mm

PH-55
200 mm

PH-55/PH-56

Forbice universale dentellata - Draht-und Blechschere gezahnt
Wire cutting scissor serrated - Ciseaux à couper les fils métalliques
Tijeras para cortar hilo de acero dentadas

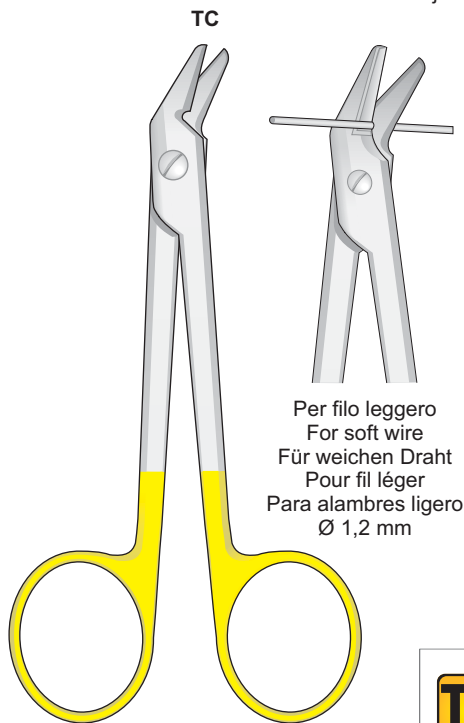

Per filo leggero
For soft wire
Für weichen Draht
Pour fil léger
Para alambres ligero
Ø 1,2 mm

TC
TUNGSTEN
CARBIDE
Tungsten-Carbide Inserts
Mit Hartmetalleinsätzen
Plaquettes en carbure de tungstène
Plaquetas de carburo de tungsteno
Inserti in carburo di tungsteno

DP-120
120 mm

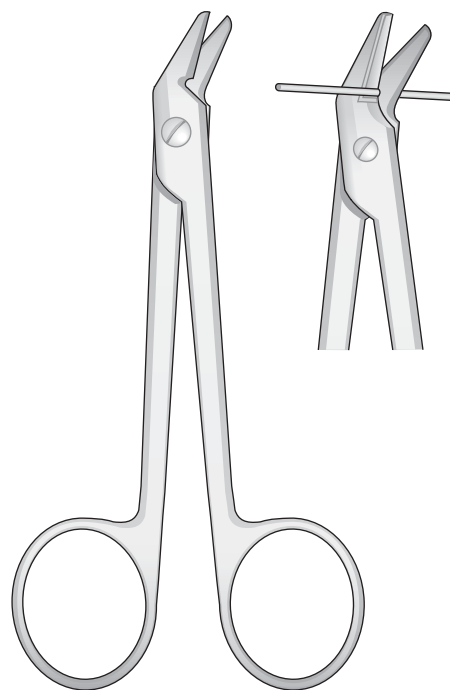

DP-90
120 mm

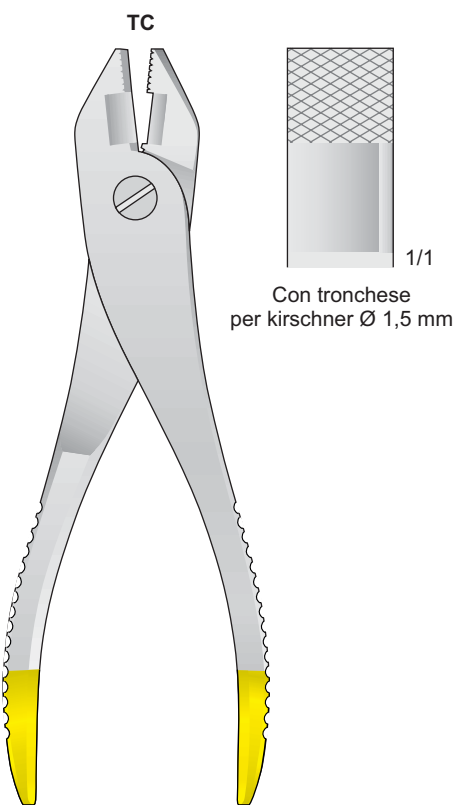

Con troncese
per kirschner Ø 1,5 mm

LX-125
220 mm

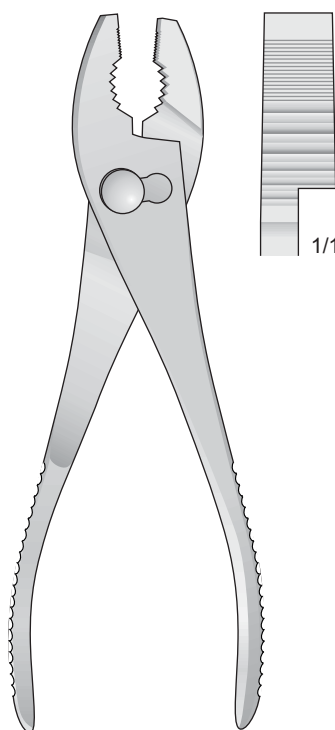

VH-40
200 mm

Per filo leggero Ø 2 mm
 Per filo duro Ø 1,5 mm
 For soft wire Ø 2 mm
 For hard wire Ø 1,5 mm
 Für weichen Draht Ø 2 mm
 Für harten Draht Ø 1,5 mm
 Pour fil léger Ø 2 mm
 Pour fil dur Ø 1,5 mm
 Para alambres ligero Ø 2 mm
 Para alambres duro Ø 1,5 mm

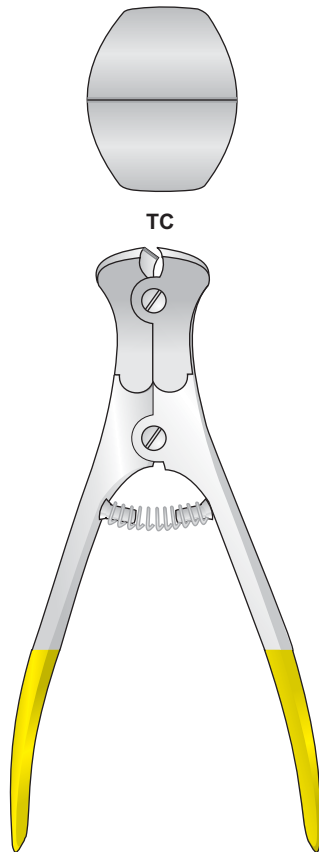

LX-102
145 mm

Per filo leggero Ø 2 mm
 Per filo duro Ø 1,6 mm
 For soft wire Ø 2 mm
 For hard wire Ø 1,6 mm
 Für weichen Draht Ø 2 mm
 Für harten Draht Ø 1,6 mm
 Pour fil léger Ø 2 mm
 Pour fil dur Ø 1,6 mm
 Para alambres ligero Ø 2 mm
 Para alambres duro Ø 1,6 mm

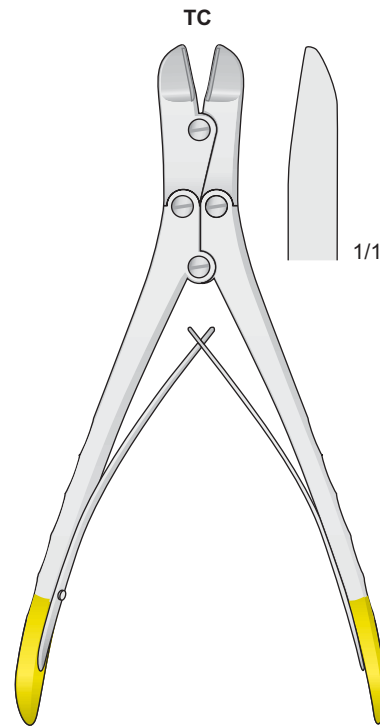

LX-103
170 mm



Tungsten-Carbide Inserts
 Mit Hartmetalleinsätzen
 Plaquettes en carbure de tungstène
 Plaquetas de carburo de tungsteno
 Inserti in carburo di tungsteno

Per filo leggero Ø 3,5 mm
 Per filo duro Ø 2,5 mm
 For soft wire Ø 3,5 mm
 For hard wire Ø 2,5 mm
 Für weichen Draht Ø 3,5 mm
 Für harten Draht Ø 2,5 mm
 Pour fil léger Ø 3,5 mm
 Pour fil dur Ø 2,5 mm
 Para alambres ligero Ø 3,5 mm
 Para alambres duro Ø 2,5 mm

Per filo leggero Ø 3 mm
 Per filo duro Ø 2,2 mm
 For soft wire Ø 3 mm
 For hard wire Ø 2,2 mm
 Für weichen Draht Ø 3 mm
 Für harten Draht Ø 2,2 mm
 Pour fil léger Ø 3 mm
 Pour fil dur Ø 2,2 mm
 Para alambres ligero Ø 3 mm
 Para alambres duro Ø 2,2 mm

Per filo leggero Ø 2,5 mm
 Per filo duro Ø 2 mm
 For soft wire Ø 2,5 mm
 For hard wire Ø 2 mm
 Für weichen Draht Ø 2,5 mm
 Für harten Draht Ø 2 mm
 Pour fil léger Ø 2,5 mm
 Pour fil dur Ø 2 mm
 Para alambres ligero Ø 2,5 mm
 Para alambres duro Ø 2 mm

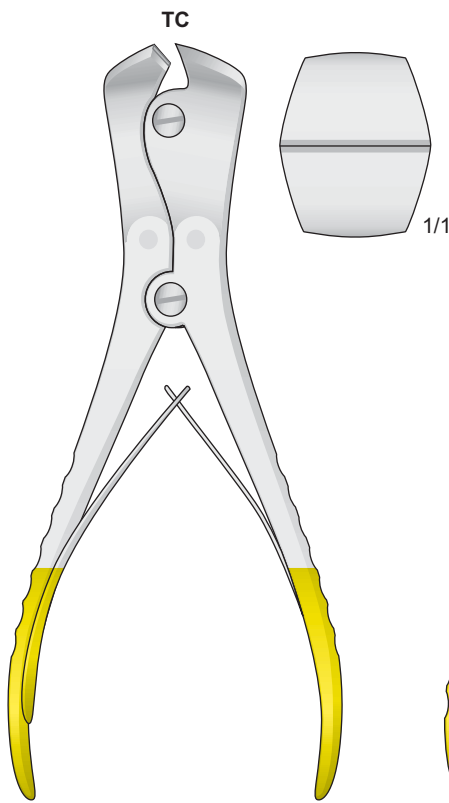

LX-104
215 mm

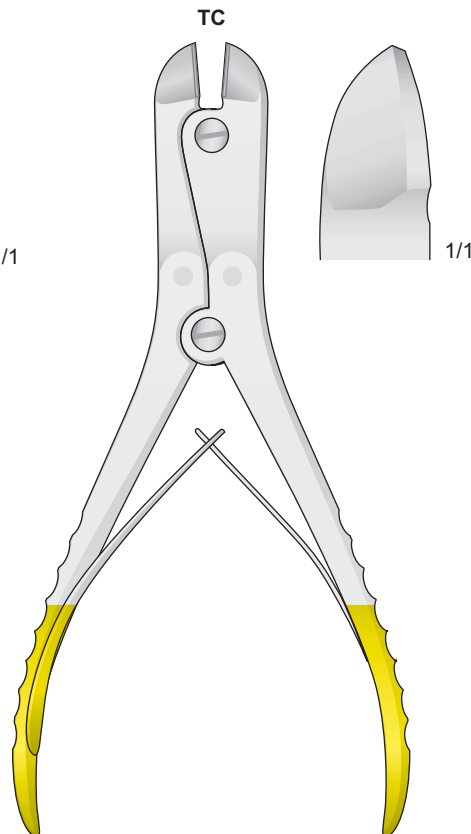

LX-106
230 mm

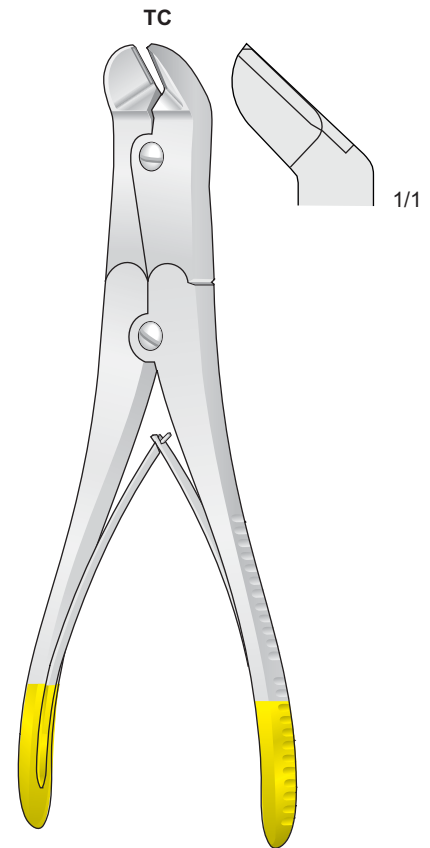

LX-105
230 mm



Tungsten-Carbide Inserts
 Mit Hartmetalleinsätzen
 Plaquettes en carbure de tungstène
 Plaquetas de carburo de tungsteno
 Inserti in carburo di tungsteno

Per filo leggero Ø 7 mm
 Per filo duro Ø 6 mm
 For soft wire Ø 7 mm
 For hard wire Ø 6 mm
 Für weichen Draht Ø 7 mm
 Für harten Draht Ø 6 mm
 Pour fil léger Ø 7 mm
 Pour fil dur Ø 6 mm
 Para alambres ligero Ø 7 mm
 Para alambres duro Ø 6 mm

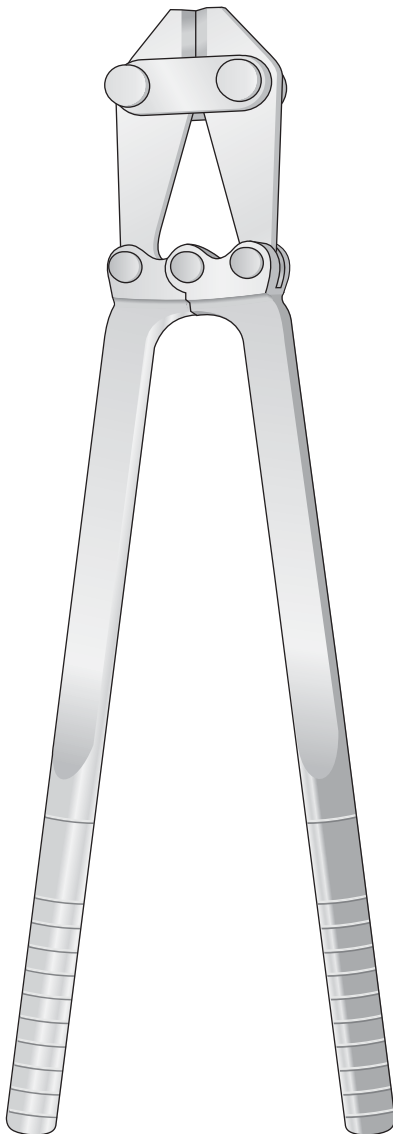

VF-98
480 mm

Per filo leggero Ø 7 mm
 Per filo duro Ø 6 mm
 For soft wire Ø 7 mm
 For hard wire Ø 6 mm
 Für weichen Draht Ø 7 mm
 Für harten Draht Ø 6 mm
 Pour fil léger Ø 7 mm
 Pour fil dur Ø 6 mm
 Para alambres ligero Ø 7 mm
 Para alambres duro Ø 6 mm

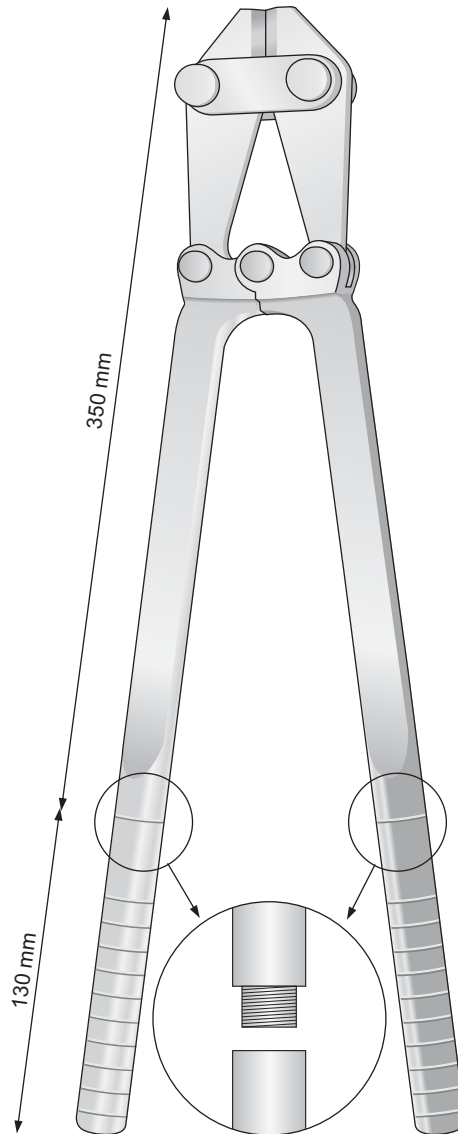

VF-98M
480 mm

Per filo leggero Ø 5 mm
 Per filo duro Ø 4,5 mm
 For soft wire Ø 5 mm
 For hard wire Ø 4,5 mm
 Für weichen Draht Ø 5 mm
 Für harten Draht Ø 4,5 mm
 Pour fil léger Ø 5 mm
 Pour fil dur Ø 4,5 mm
 Para alambres ligero Ø 5 mm
 Para alambres duro Ø 4,5 mm

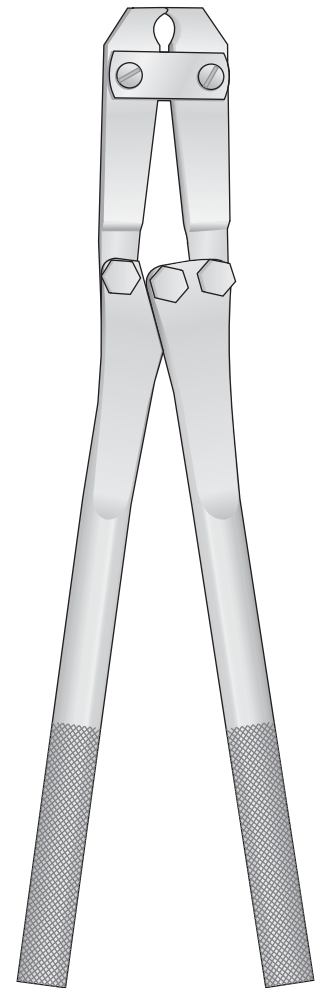

LX-107
375 mm

Centratori guida punta - Drill guides - Bohrbüchsen zu Knochenplatten - Guide méche

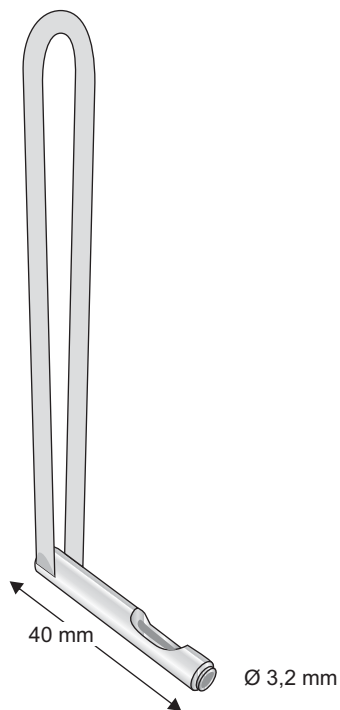

LS-117
125 mm

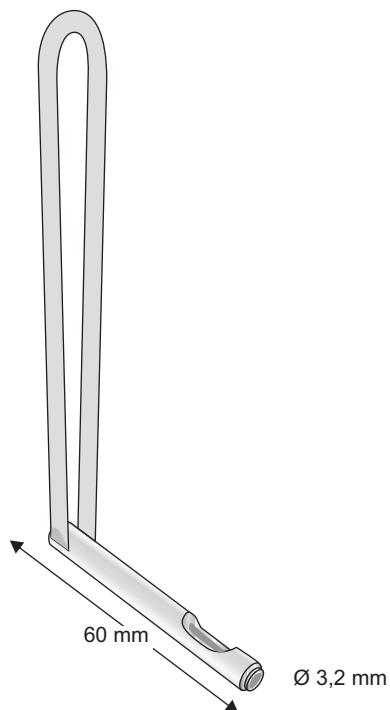

LS-124
125 mm

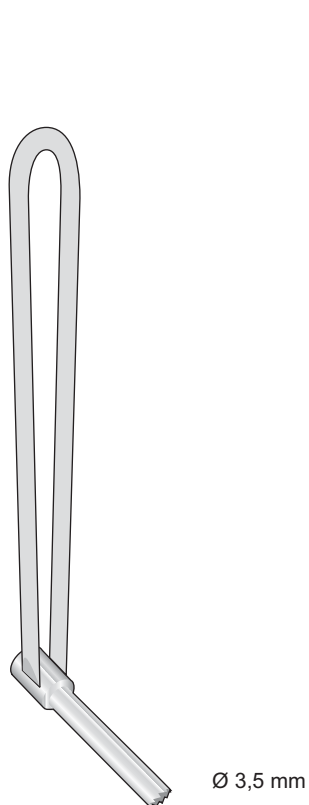

LS-116
125 mm

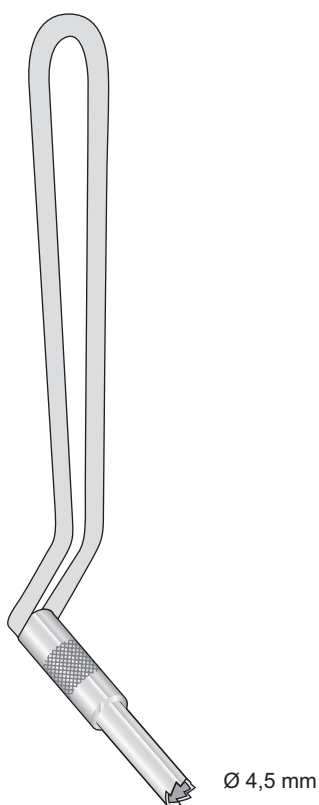

LS-119
150 mm

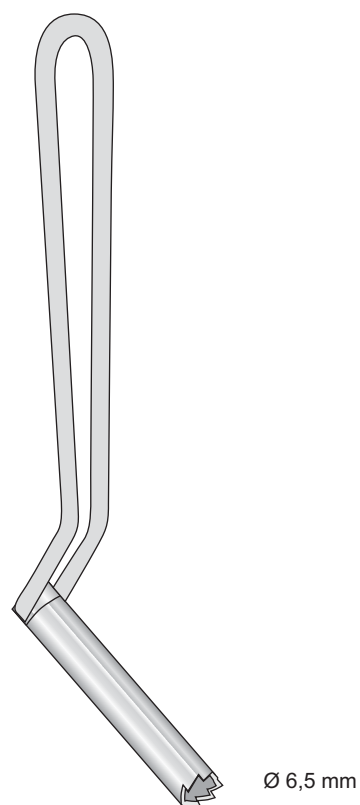

LS-121
150 mm

Giraviti - Screws driver - Schraubenzieher - Jeu de tournevis - Destornilladores

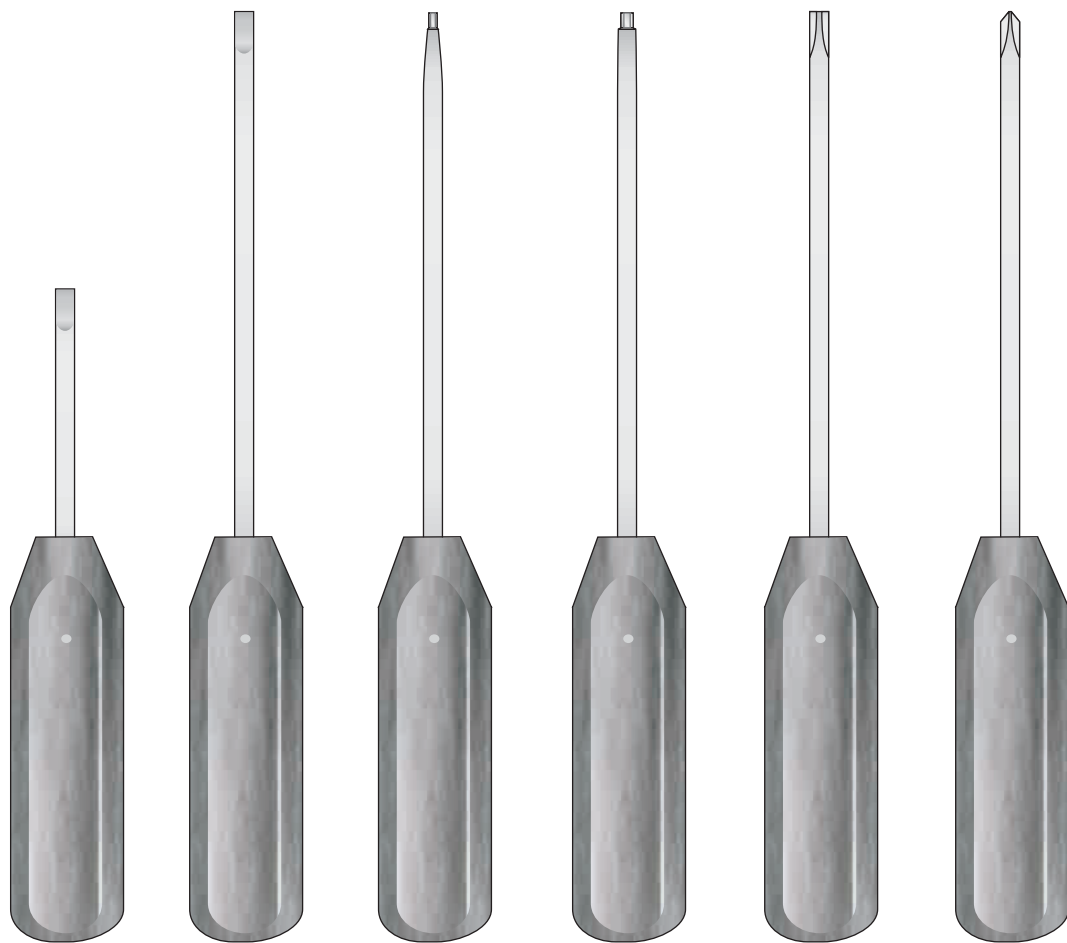
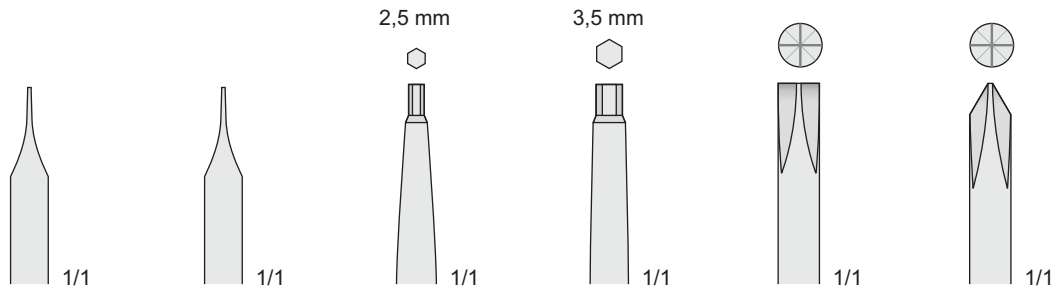

LS-310
170 mm

LANE
LS-311
250 mm

LS-312
250 mm

LS-313
250 mm

LS-314
250 mm

PHILIPS
LS-315
250 mm

13

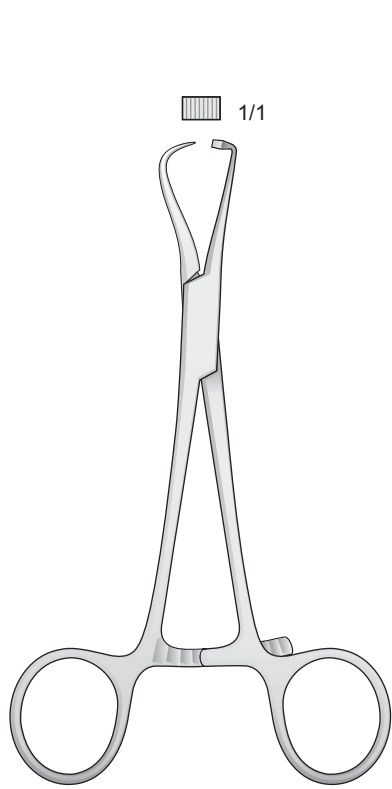

LS-76
120 mm

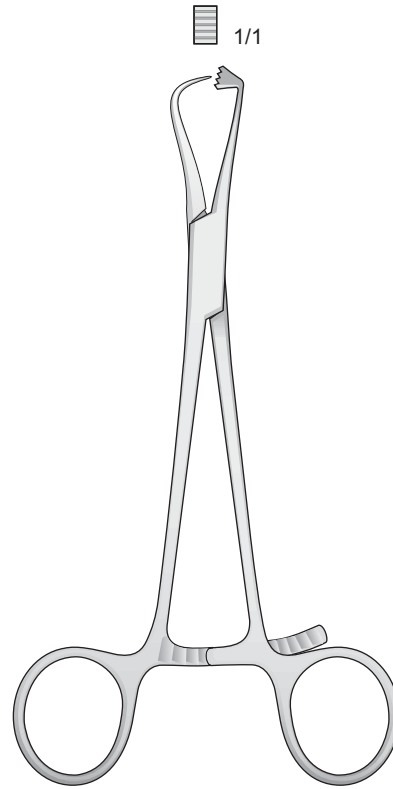

LS-78
125 mm

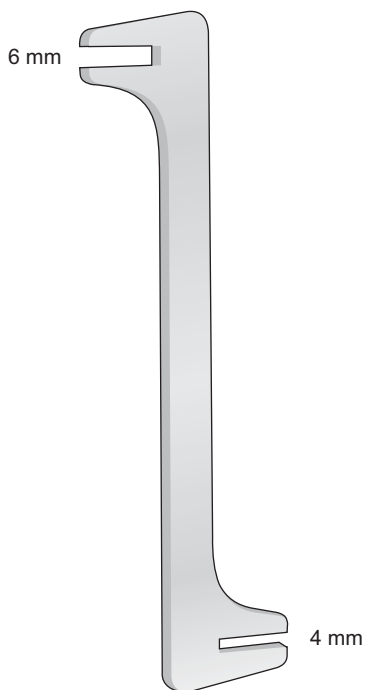

LS-101
180 mm

Per placche da
2,7 mm e 3,5 mm



LS-103 100 mm
LS-102 140 mm

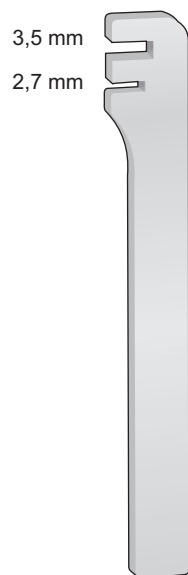

LS-123 100 mm
LS-122 140 mm



LS-104
100 mm

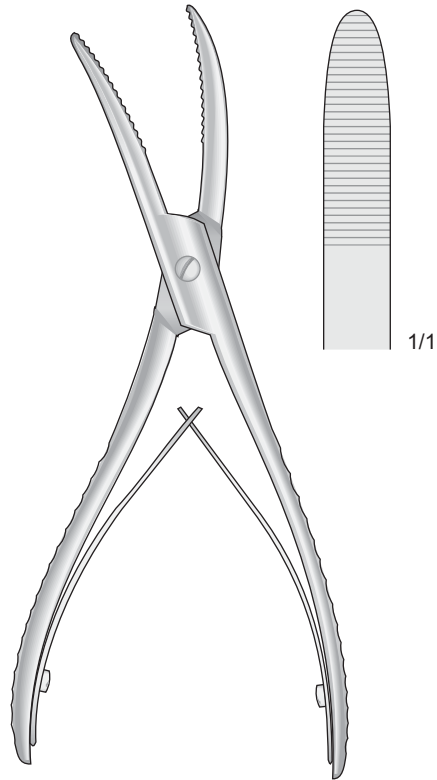

WOLFF
LX-113
180 mm

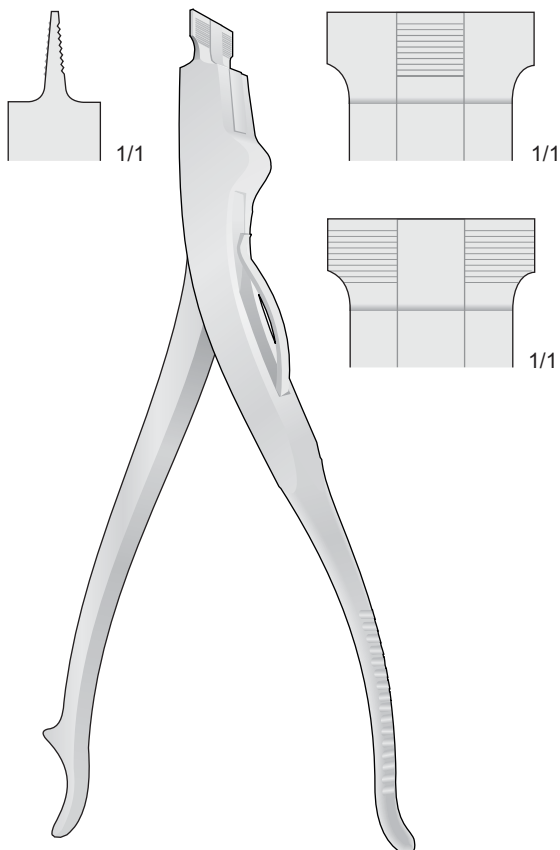

LAWTON
LX-115
220 mm

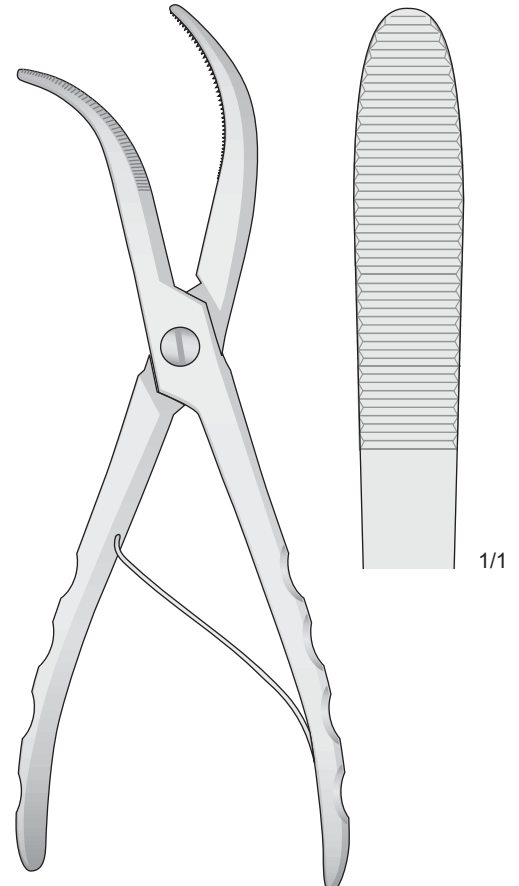

WOLFF
LX-114
250 mm

Cesoie per gesso
 Gips - Schneidezangen

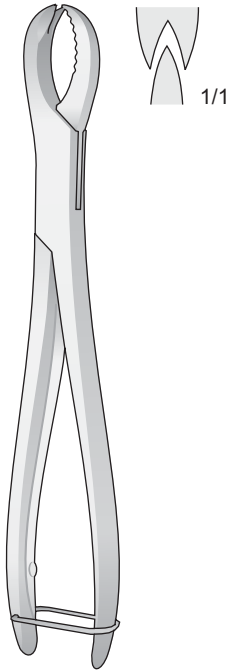

BK-30
 210 mm

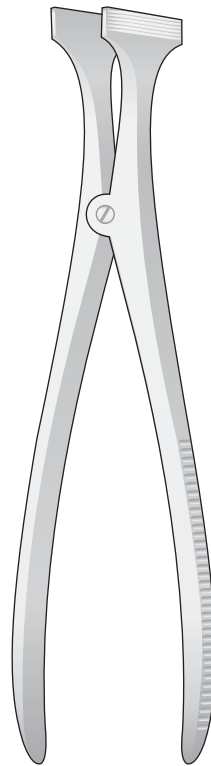

HENNIG
LX-123
 270 mm

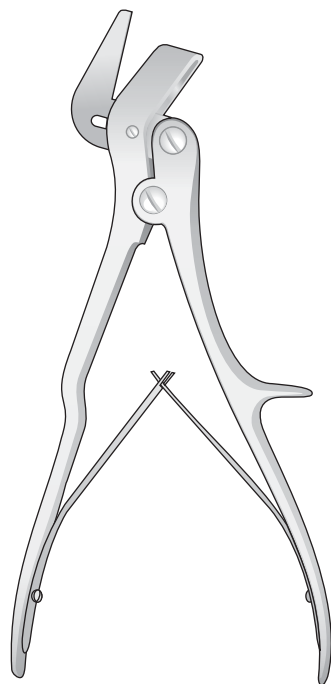
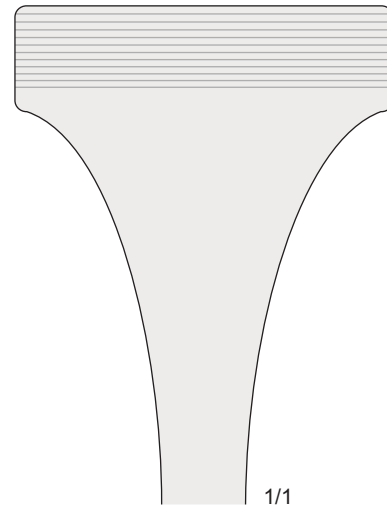

STILLE
LX-120
 230 mm

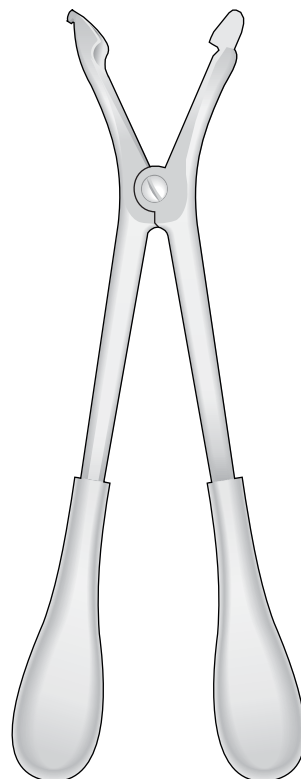

HAGLUND
LX-121
 280 mm

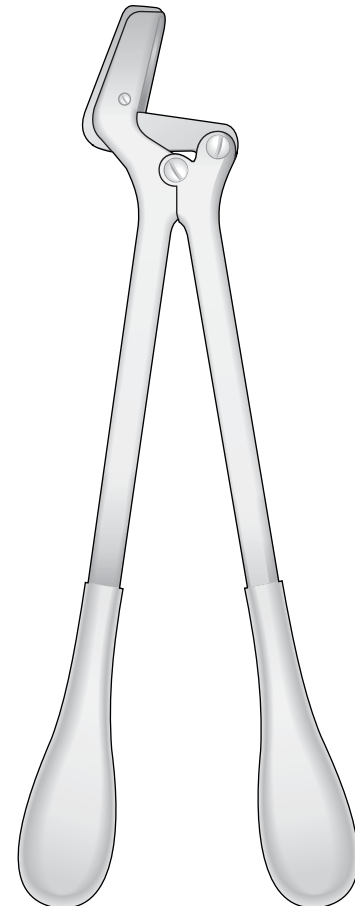

STILLE
LX-122
 370 mm

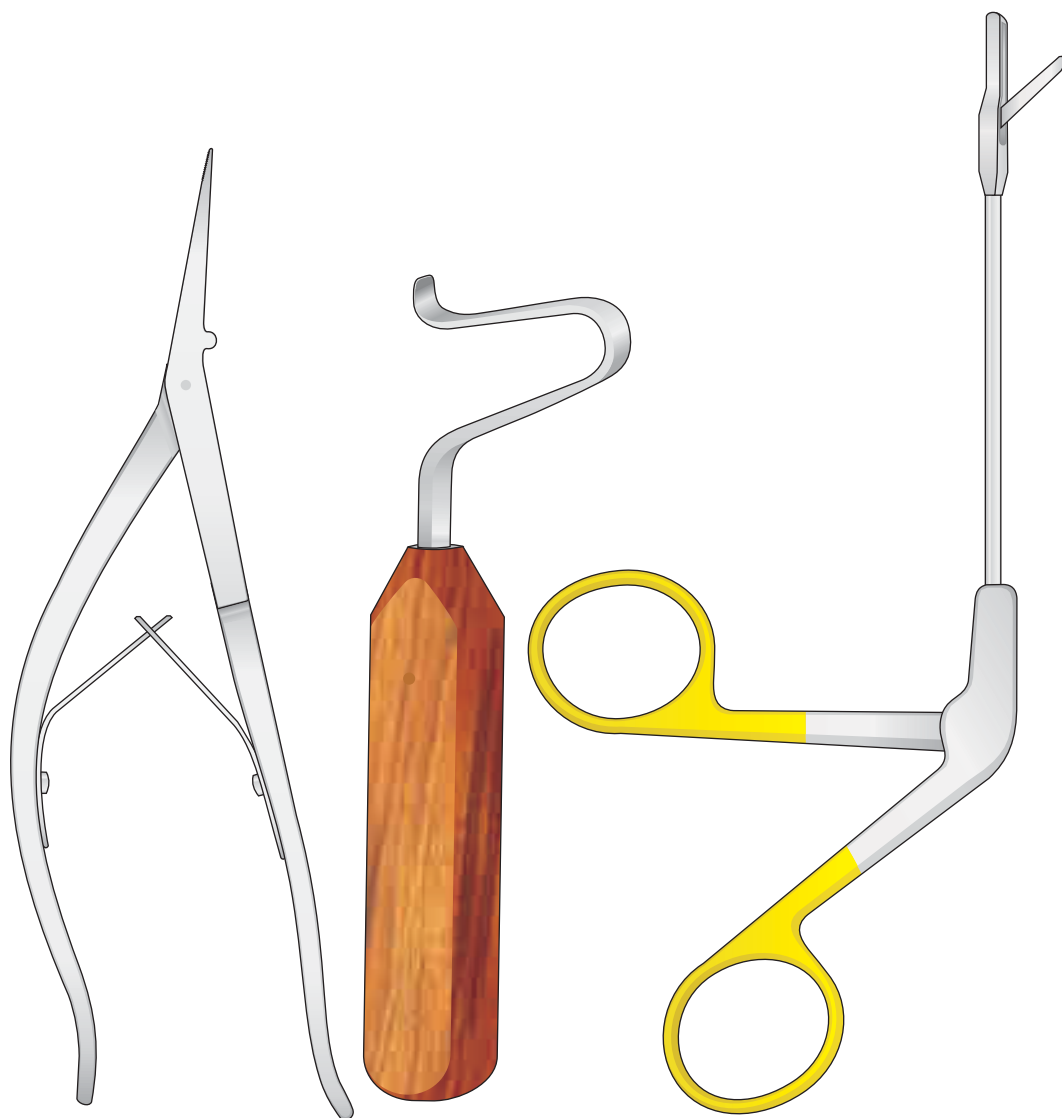

14 |

ENT - Otolaryngology
HNO - Heilkunde
ORL - Oto-rhino-laryngologie
ORL - Otorrinolaringología
ORL - Otorinolaringoiatria

Per adulti - For adults
Für Erwachsene - Pour adultes
Para adultos

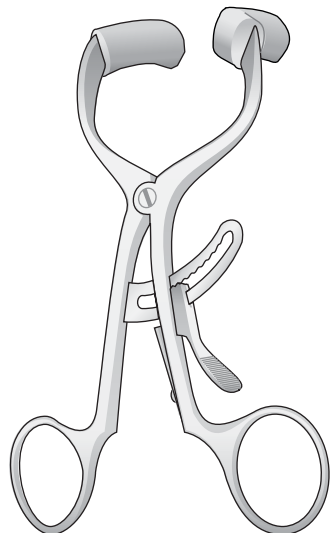

DOYEN-JANSEN
OM-41
140 mm

Per adulti - For adults
Für Erwachsene - Pour adultes
Para adultos

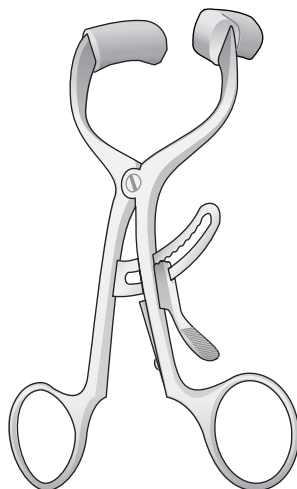

DOYEN-COLLIN
OM-40
120 mm

Per bambini
For children
Für Kinder
Pour enfants
Para niños

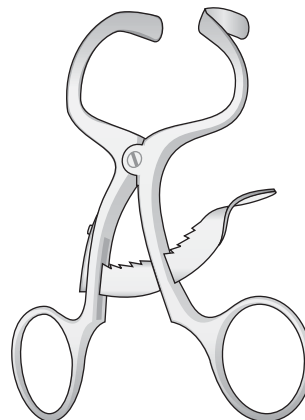

MOLT
OM-42
100 mm

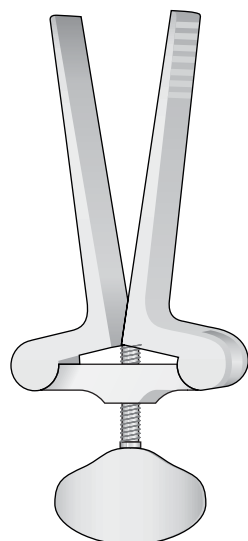

HEISTER
OM-62
135 mm

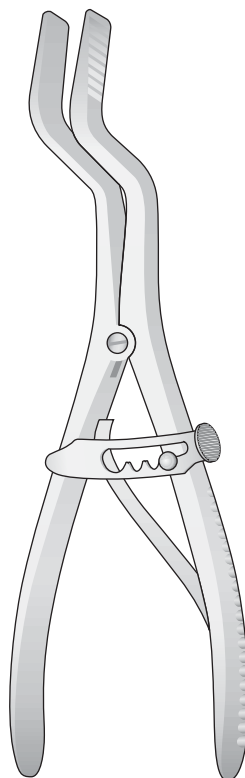

ROSER KÖNIG
OM-60
185 mm

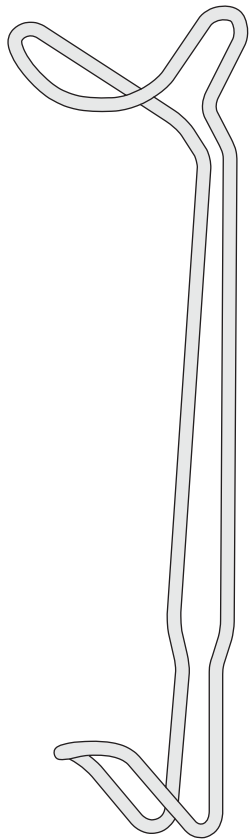

OM-58
210 mm

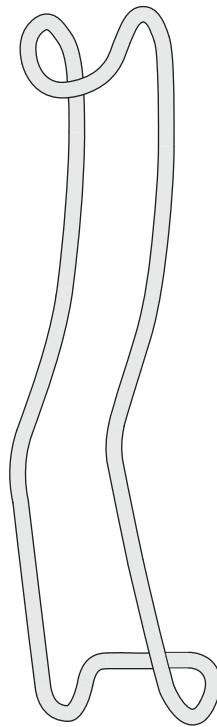

STERNBERG
OM-50
160 mm

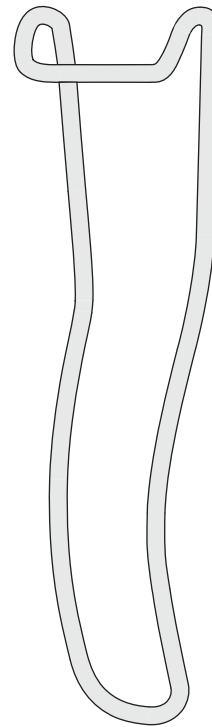

STERNBERG
OM-52
160 mm

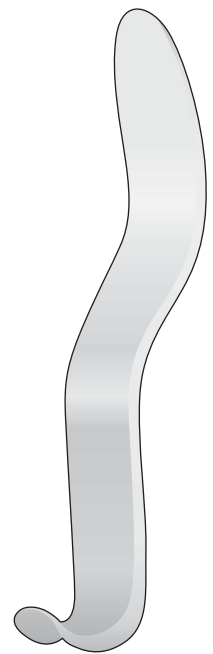

MINNESOTA
OM-55
140 mm

Apribocca solo
Gag only
Sperrer allein
Manche et cadreseuls
Apre-boca suelto

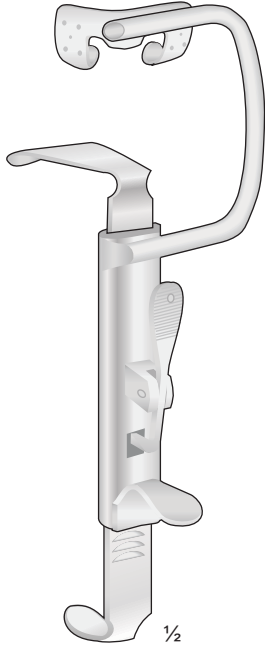

DAVIS-BOYLE
OM-141

DAVIS-BOYLE
OM-140
Completo con 5 abbassalingua
Complete with 5 tongue depressors
Komplet mit 5 Zungenspatel
Complet avec 5 abaisse-langues
Completo con 5 abaja lengua

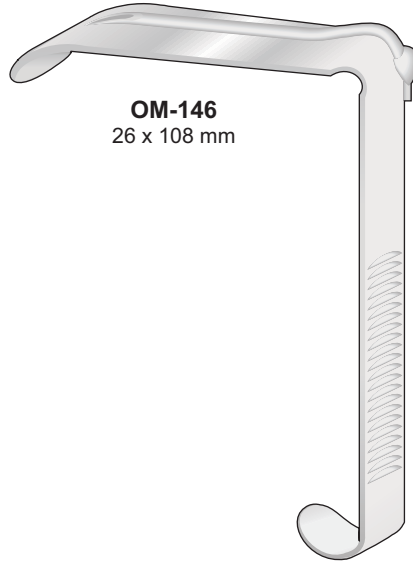

OM-146
26 x 108 mm



OM-145
25 x 93 mm



OM-144
24 x 80 mm



OM-143
23 x 65 mm

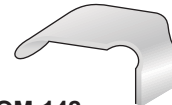

OM-142
21 x 30 mm

Mc-IVOR
OM-170
Completo di 3 abbassalingua
Complete with 3 tongue depressors
Komplet mit 3 Zungenspatel
Complet avec 3 abaisse-langues
Completo con 3 abaja lengua

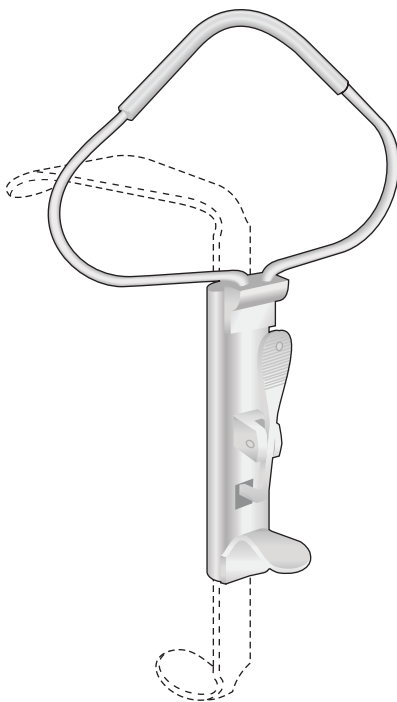

Mc-IVOR
OM-171



OM-174
26 x 100 mm

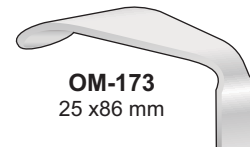

OM-173
25 x 86 mm

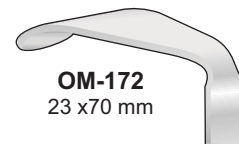

OM-172
23 x 70 mm

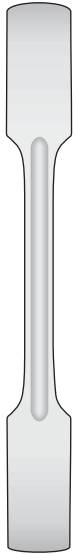

DS-01
110 mm

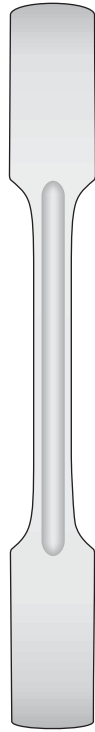

DS-02
160 mm



OM-98
195 mm

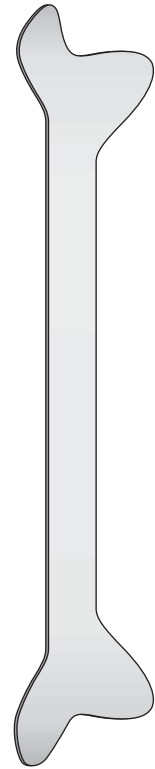

OM-100
180 mm

Spatole inox malleabili
Spatulas malleable

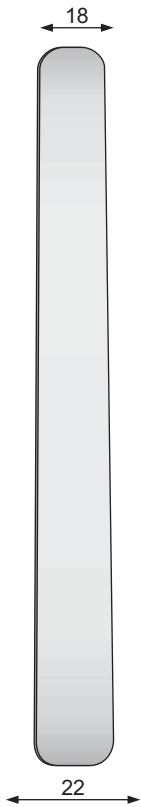

OM-80
200 mm

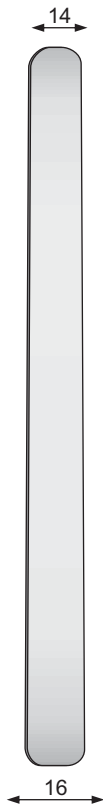

OM-81
200 mm



OM-82
240 mm

Spatole Inox malleabili antiriflesso nere
Spatulas malleable black anodized



OM-87
200 mm

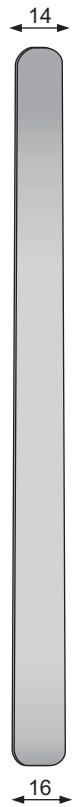

OM-88
200 mm

14

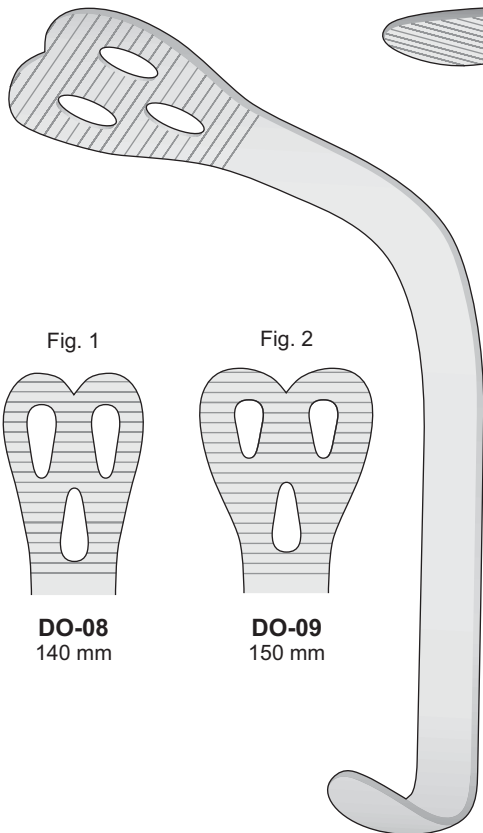
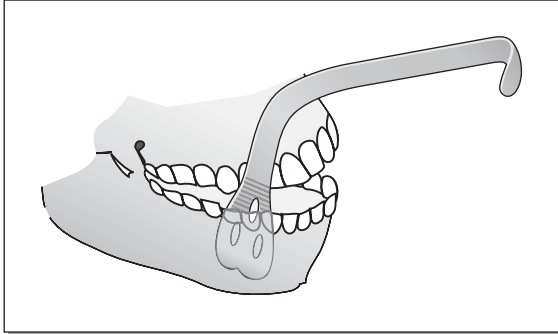
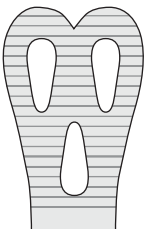
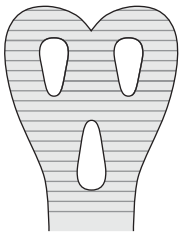

Fig. 1



DO-08
140 mm

Fig. 2



DO-09
150 mm

WIEDER
DO-08/DO-09

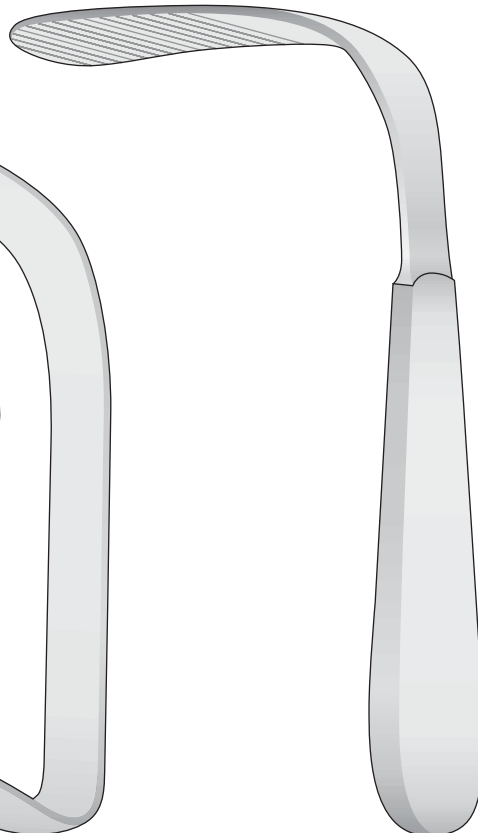

TOBOLD
OM-08
145 mm

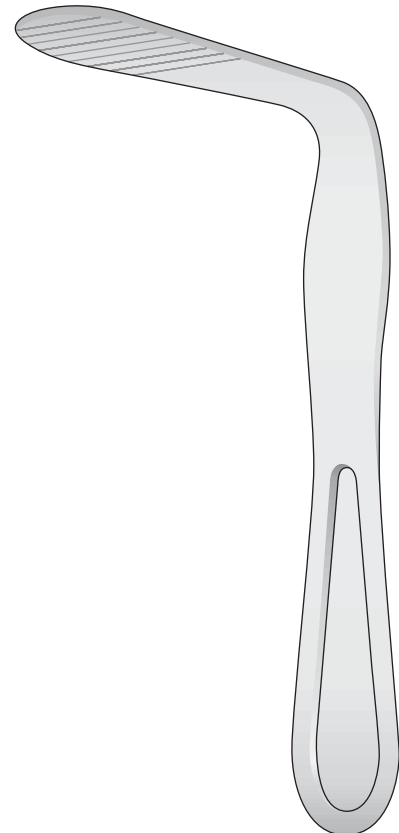

HARTMANN
OM-06
150 mm

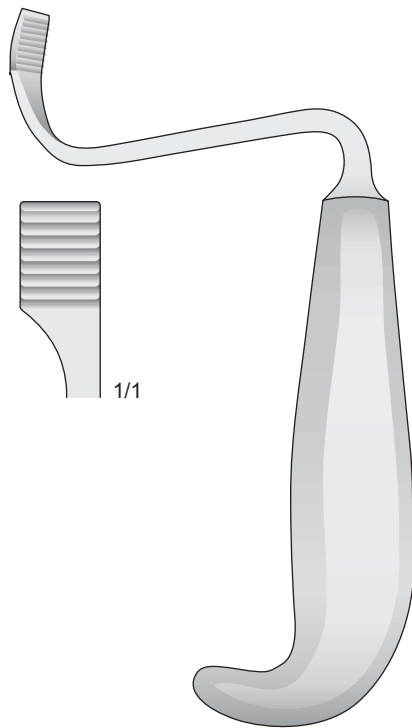

TESSIER
DO-42
150 mm

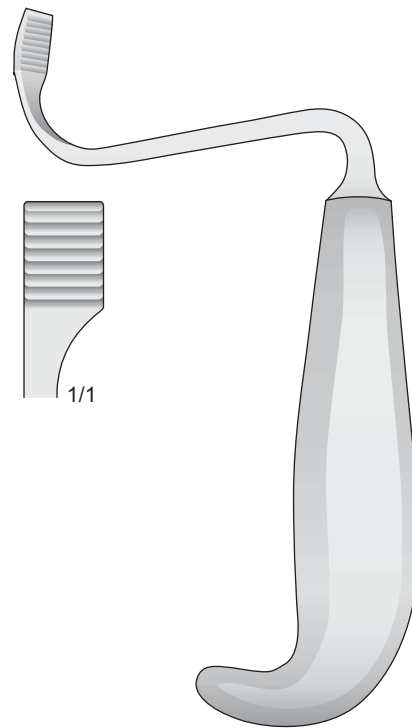

TESSIER
DO-43
150 mm

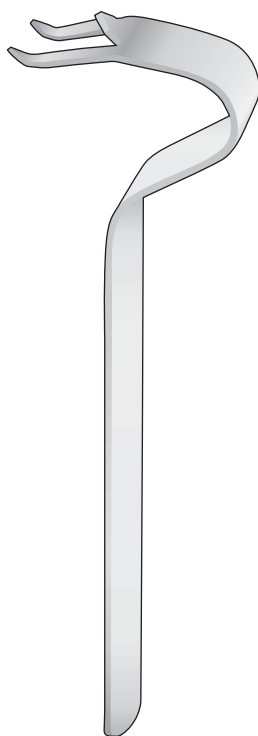

OBWEGESER
DO-40
155 mm

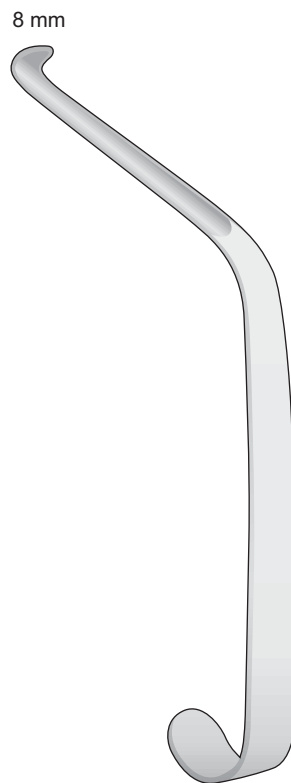

OBWEGESER
DO-41
165 mm

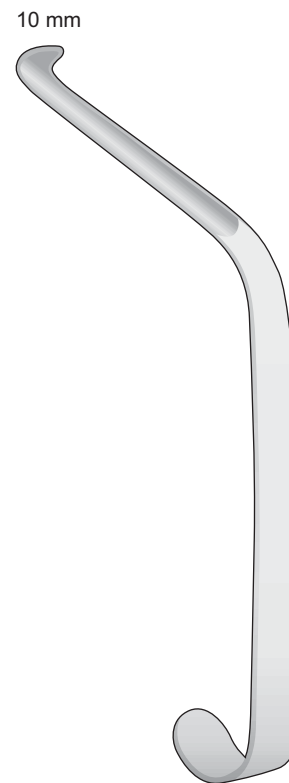

OBWEGESER
DO-142
165 mm

14



6 x 13 mm

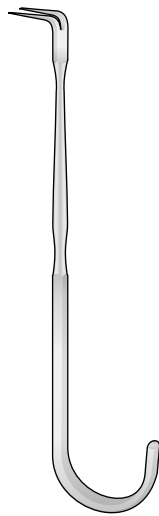

DUNN-DAUTREY
DO-198
130 mm

8 x 18 mm

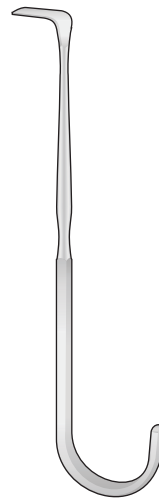

DUNN-DAUTREY
DO-199
125 mm

Posteriore

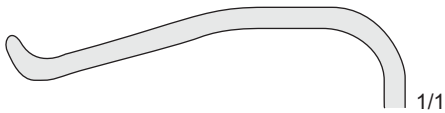

Anteriore

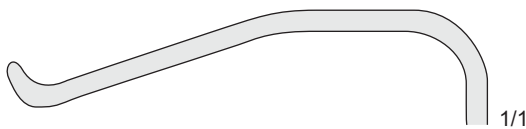

Superiore

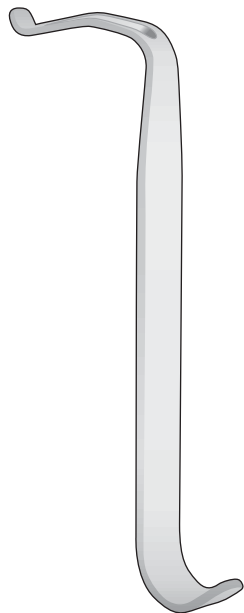

DUNN-DAUTREY
DO-94 6,5 x 50 mm
140 mm

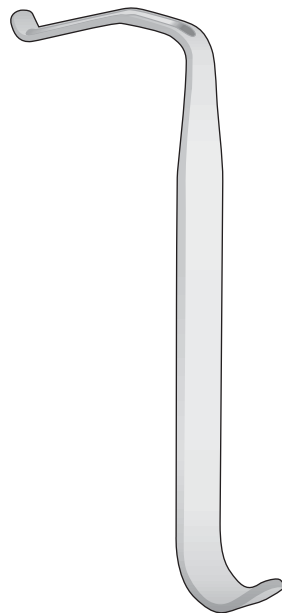

DUNN-DAUTREY
DO-95 6,5 x 60 mm
140 mm

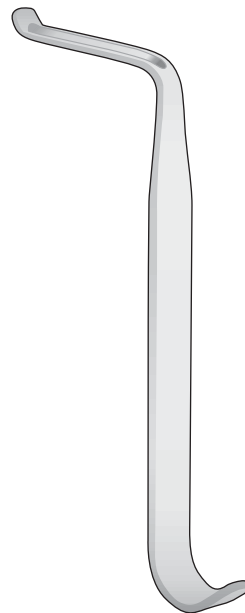

DUNN-DAUTREY
DO-96 8 x 50 mm
140 mm

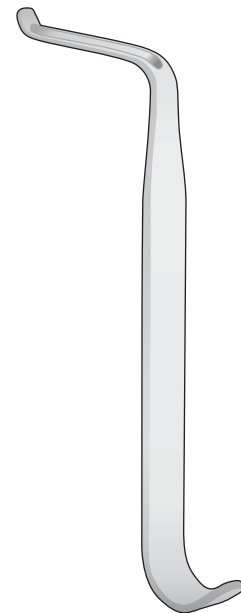

DUNN-DAUTREY
DO-97 6,5 x 50 mm
140 mm

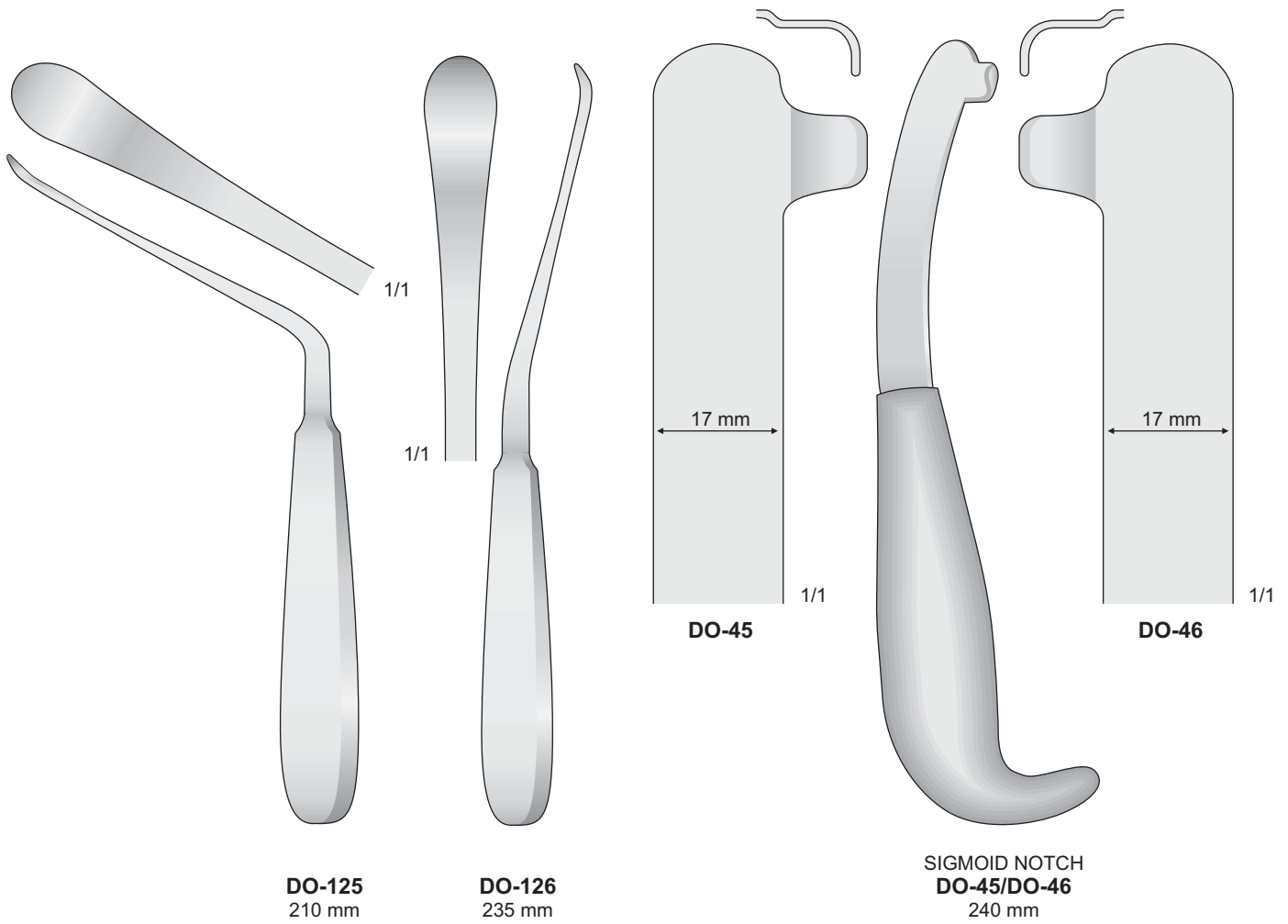

14

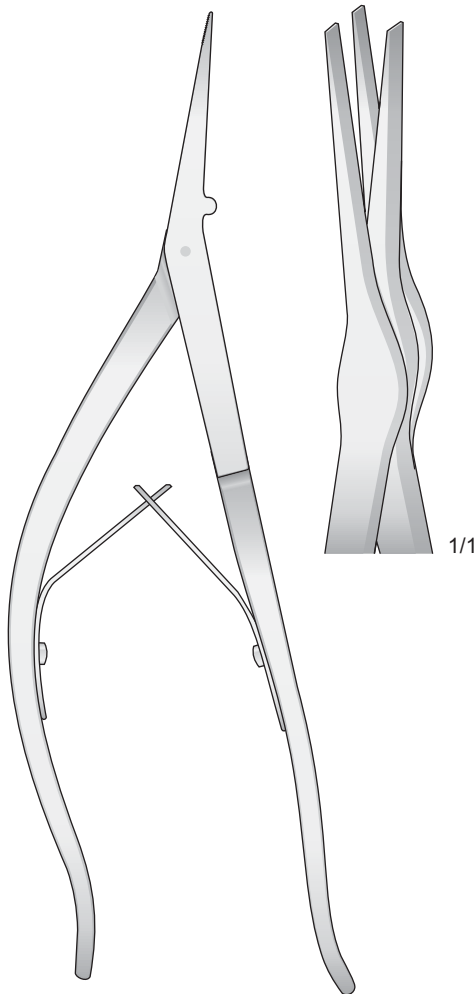
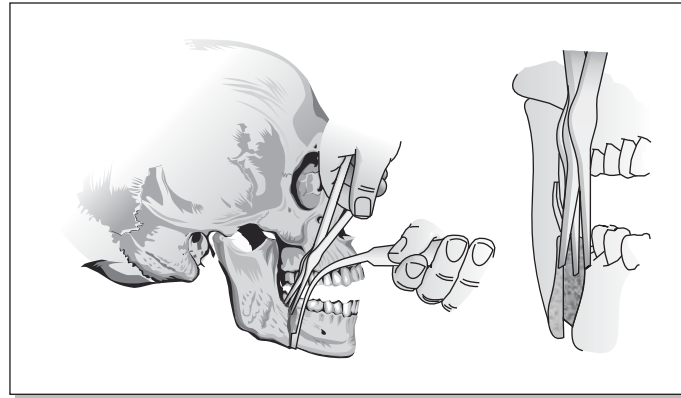

**RAMUS
DO-247**
230 mm

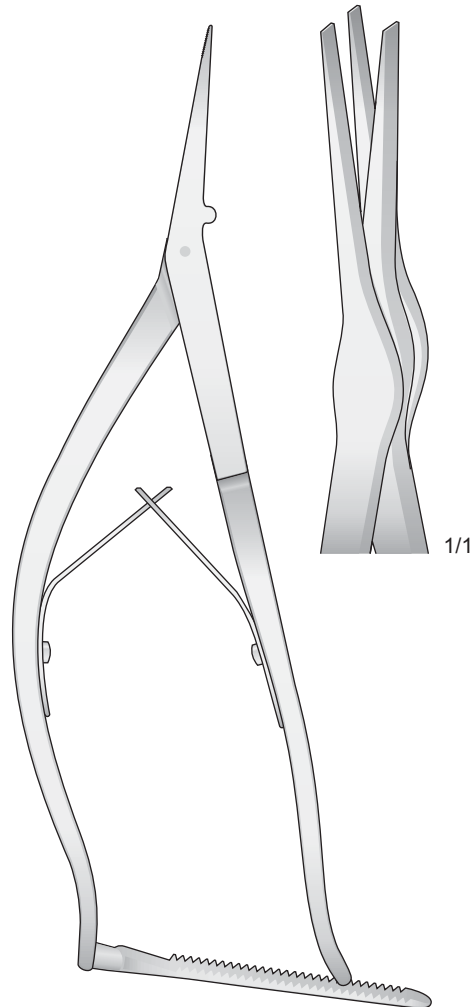

**RAMUS
DO-248**
230 mm

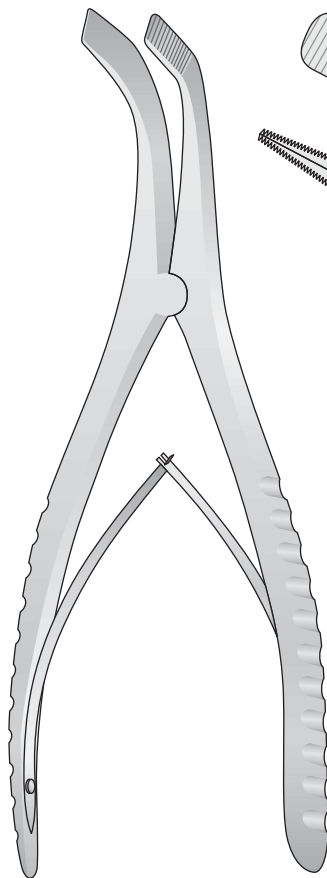
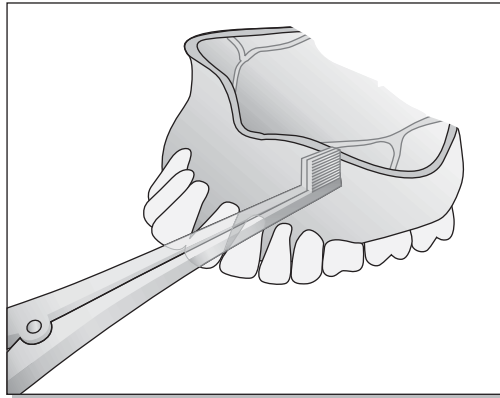

TESSIER
DO-19
180 mm

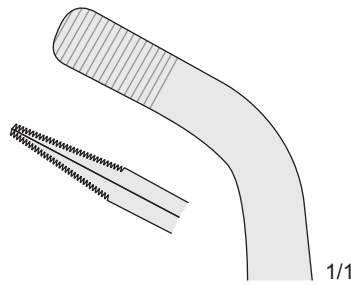

Maxillary expander

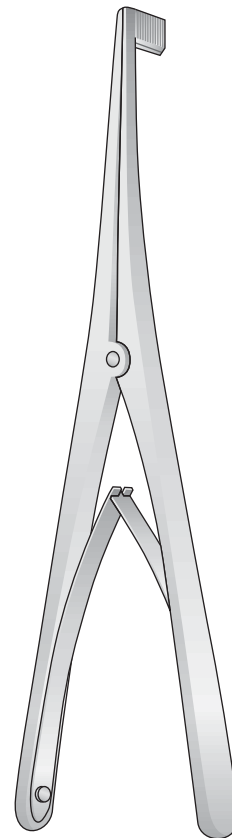

DO-29
170 mm

Lattanti
For juveniles
Für Jugendliche

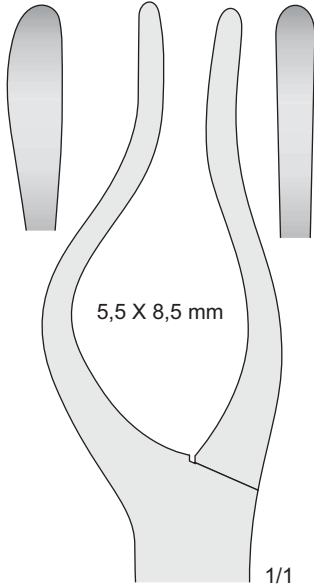

DO-10
DO-11
225 mm

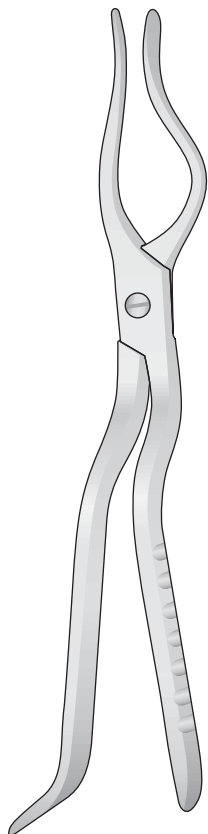

ROWE

Per bambini
For children
Für Kinder
Pour enfants
Para niños

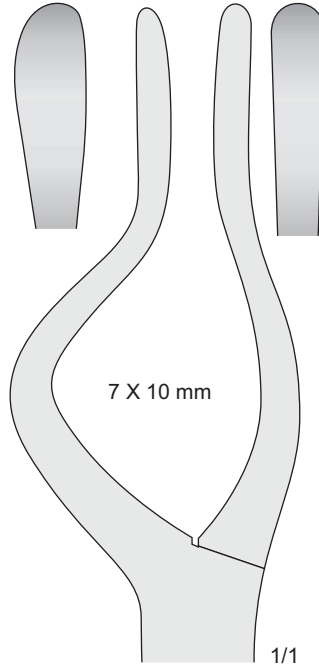

DO-12
DO-13
235 mm



ROWE

Per adulti
For adults
Für Erwachsene
Pour adultes
Para adultos

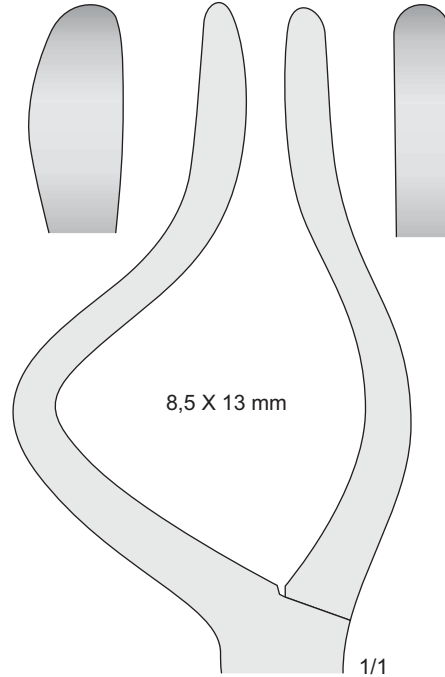

DO-14
DO-15
240 mm

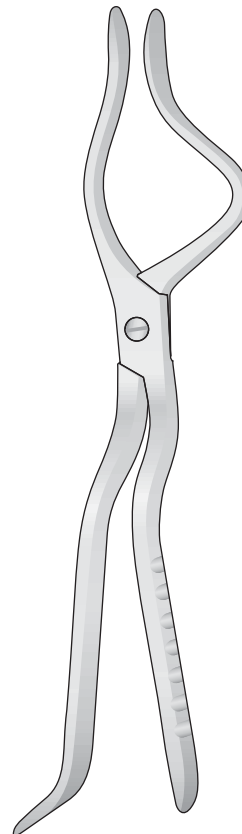

ROWE

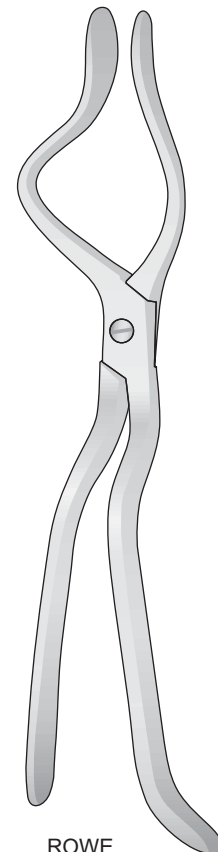

ROWE

Curette - Curettes - Löffel - Curettes - Curetas

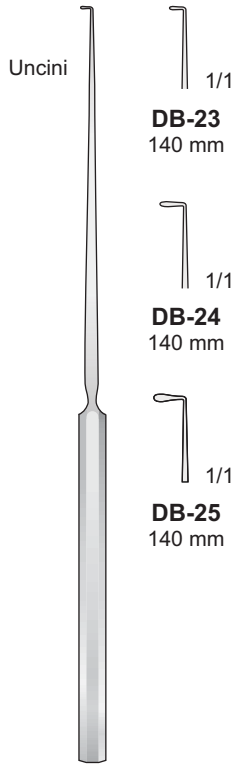

LUCAE
DB-23/DB-25
140 mm

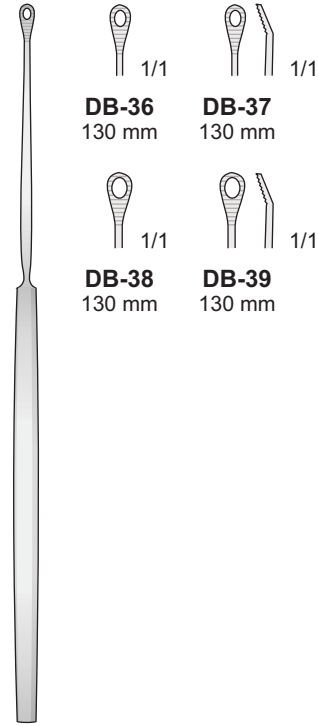

SHAPLEIGH
DB-36/DB-39
130 mm

Uncini

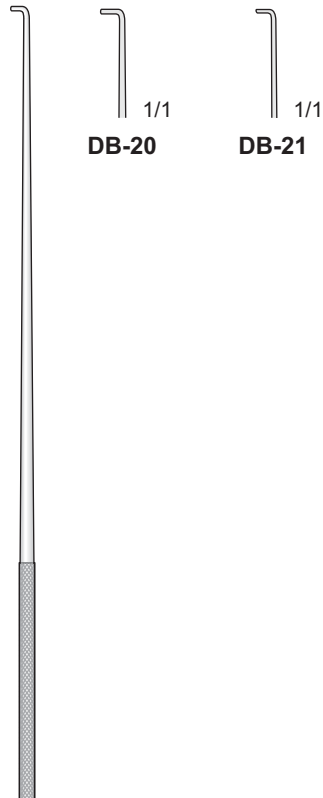

DAY
DB-20/DB-21
160 mm

Anse auricolari - Ear loops anses - Ohrschlingen - Ansas auriculares

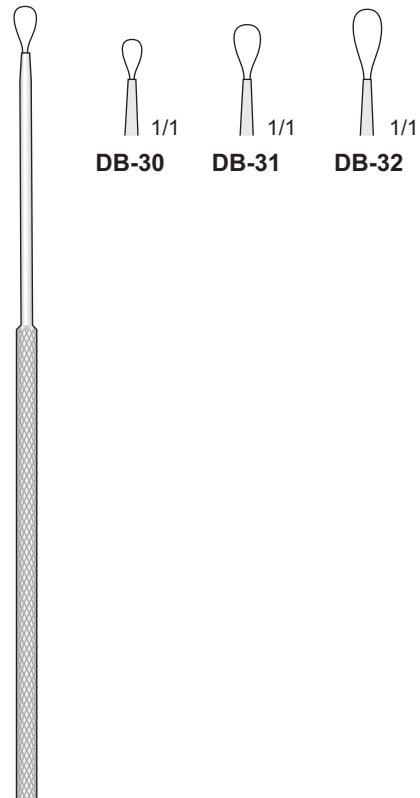

BILLEAU
DB-30/DB-32
160 mm

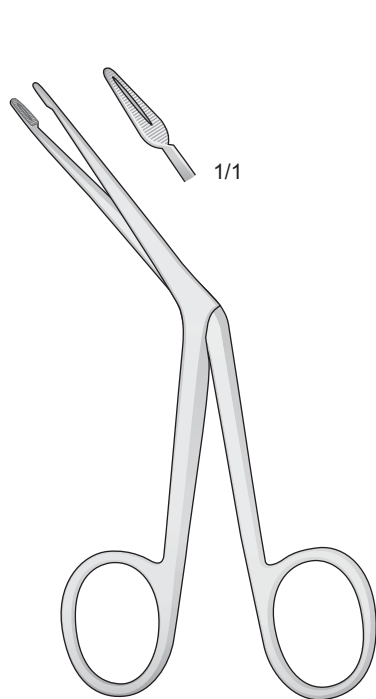
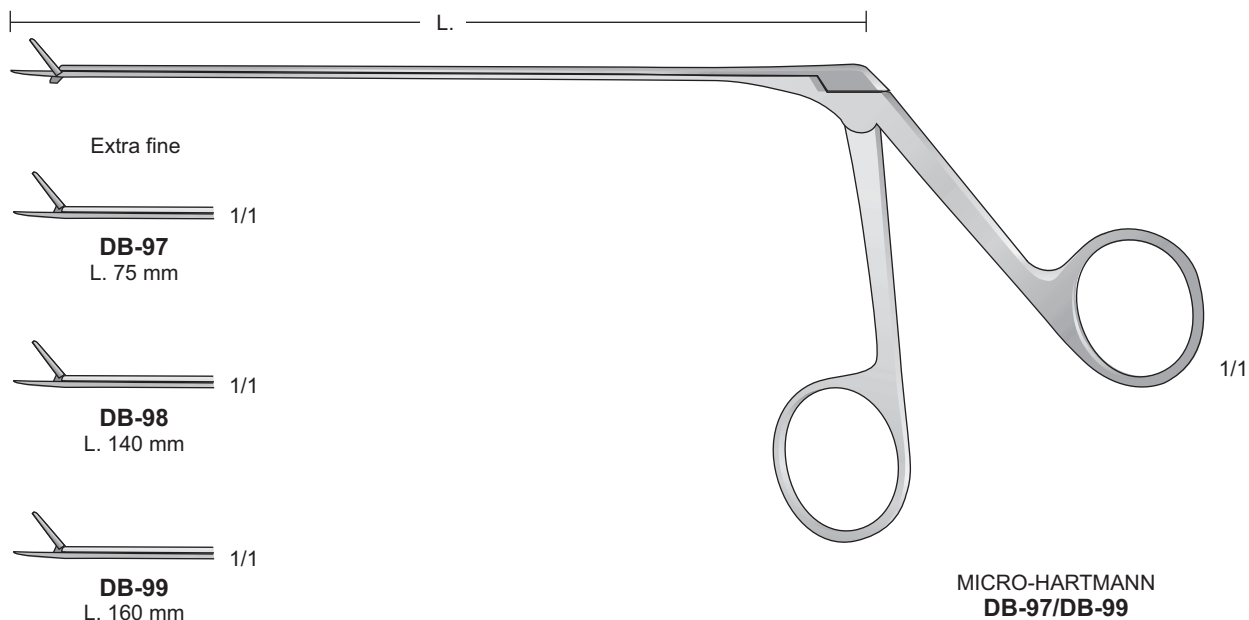

LITTAUER
DB-111
120 mm

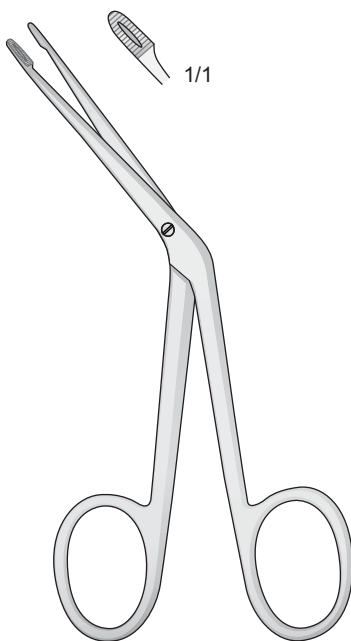

HARTMANN
DB-113
120 mm

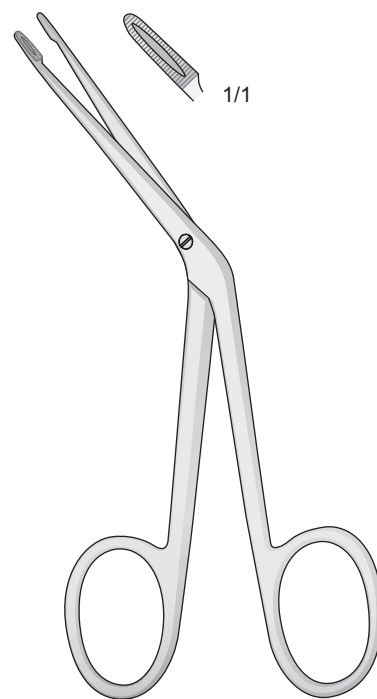

HARTMANN
DB-114
140 mm

Pinze auricolari
Ear Forceps
Ohr-Polypenzangen
Pinces pour polypes auriculaires
Pinzas auricolàres

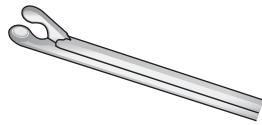

DB-124
L.85 mm

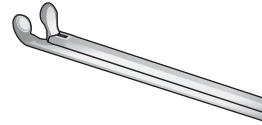

DB-125
L.85 mm

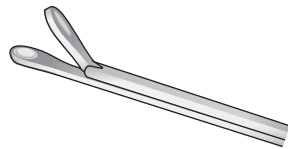

DB-129
L.85 mm

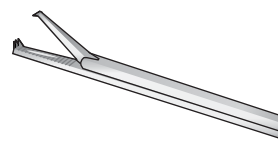

DB-123
L.85 mm

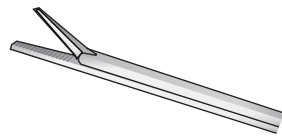

DB-120
L.85 mm

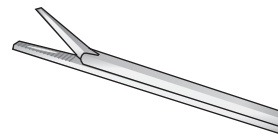

DB-121
L.140 mm
DB-122
L.165 mm

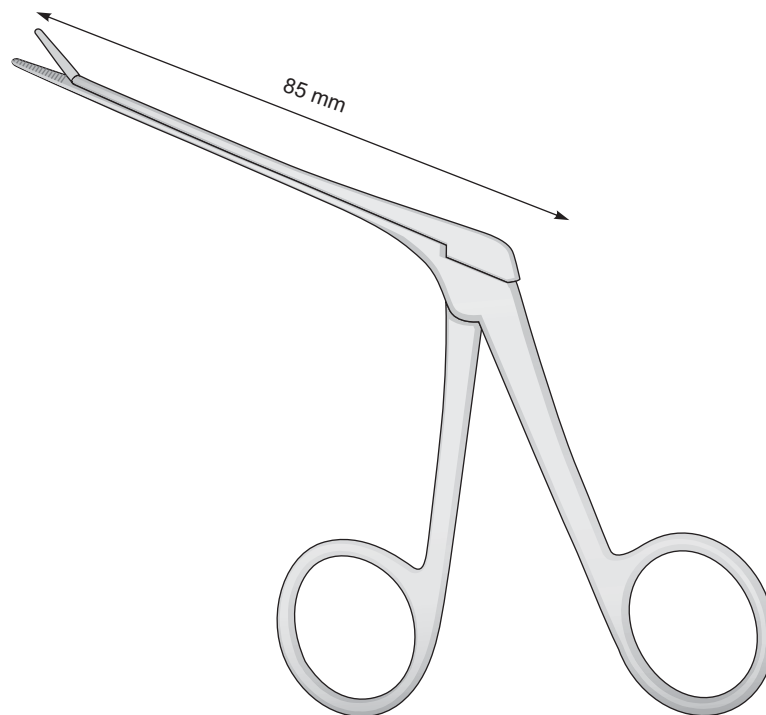

DB-120/DB-129
L. 85 mm

Micro forbice
Micro scissor
Mikro Scheren
Micro ciseaux
Micro tijeras

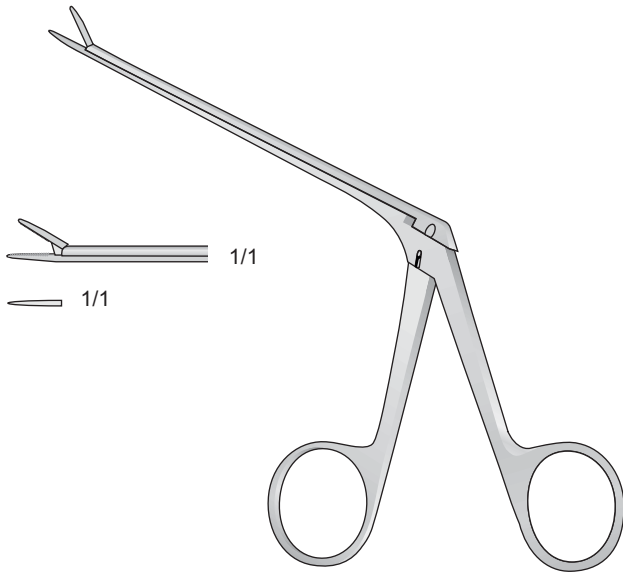

DB-100
80 mm

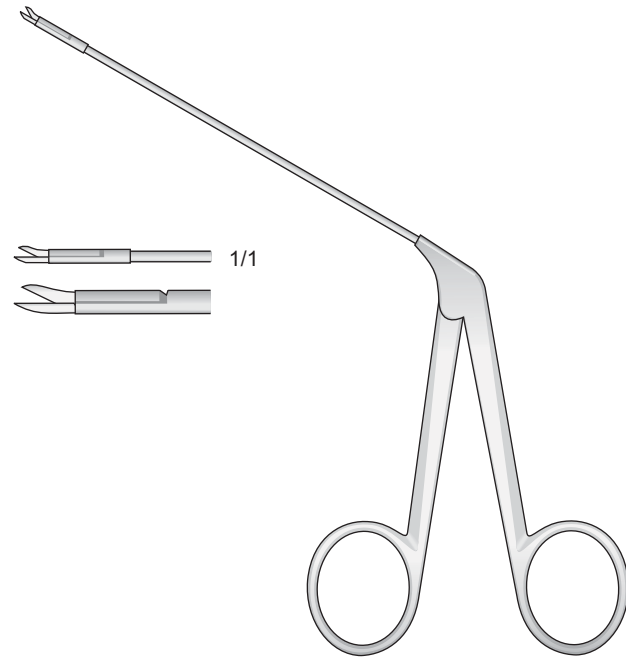

BELLUCCI
DB-106
80 mm

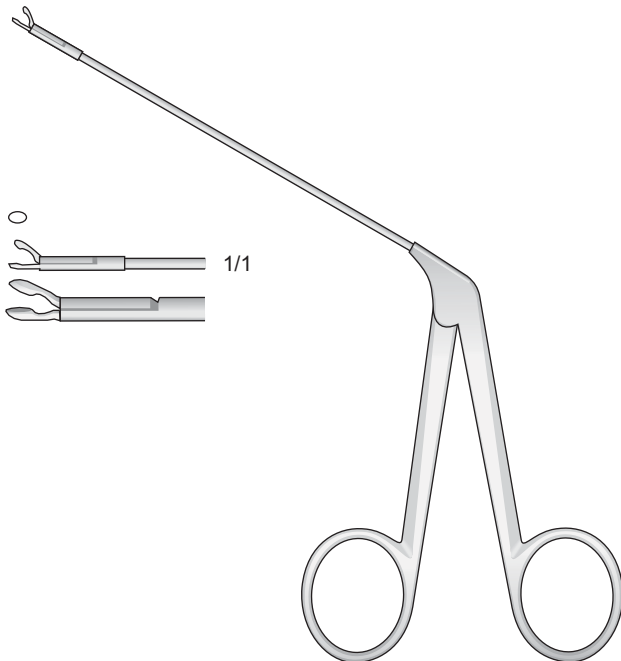

WULLSTEIN
DB-107
80 mm

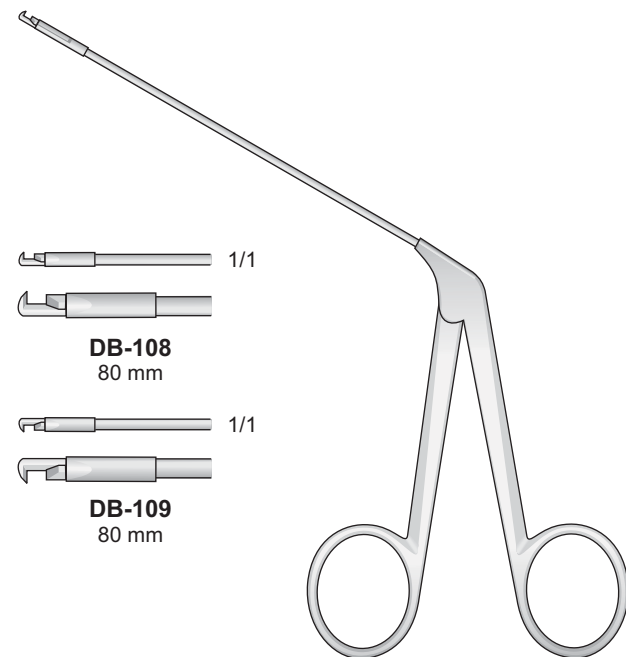

DB-108
80 mm

DB-109
80 mm

DIETER
DB-108/DB-109
80 mm

Mikro-Schere

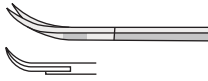

FAHLBUSCH
FF-401
165 mm

FAHLBUSCH
FF-411
230 mm

Scharfe Zange

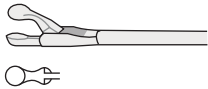

NICOLA
FF-402
165 mm

NICOLA
FF-412
230 mm

Mikro-Schere

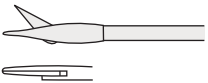

NICOLA
FF-403
165 mm

NICOLA
FF-413
230 mm

Faßzange

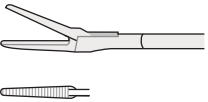

YASARGIL-NICOLA
FF-404
165 mm

YASARGIL-NICOLA
FF-414
230 mm

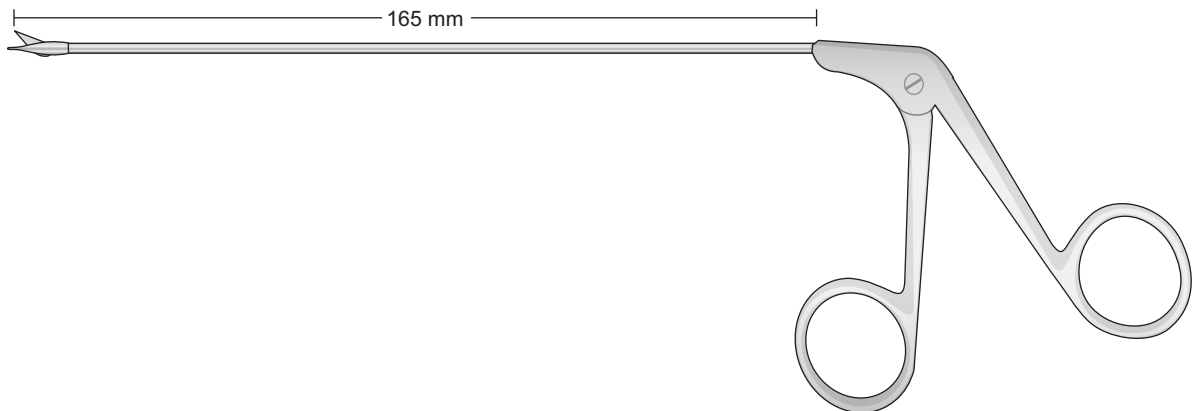

NICOLA
FF-403
165 mm

100 mm

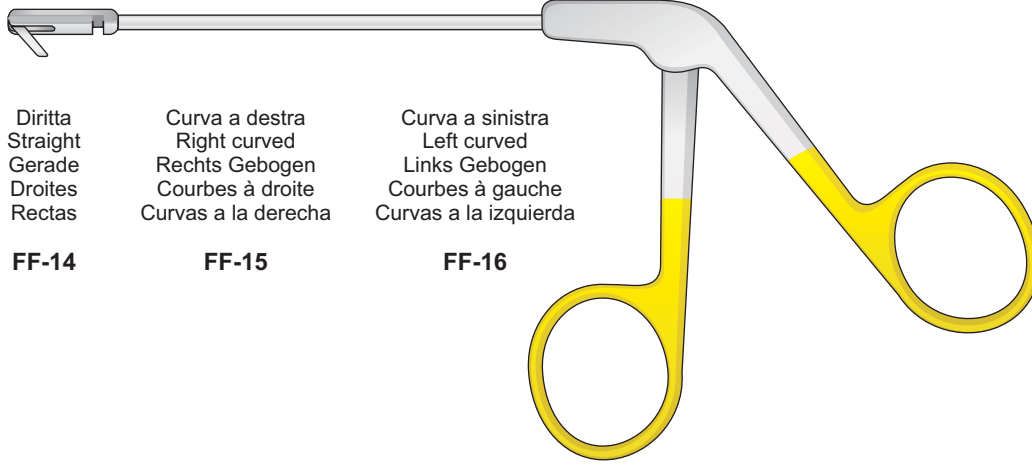

Diritta
Straight
Gerade
Droites
Rectas

FF-14

Curva a destra
Right curved
Rechts Gebogen
Courbes à droite
Curvas a la derecha

FF-15

Curva a sinistra
Left curved
Links Gebogen
Courbes à gauche
Curvas a la izquierda

FF-16

STAMBERGER
FF-14/FF-16

100 mm

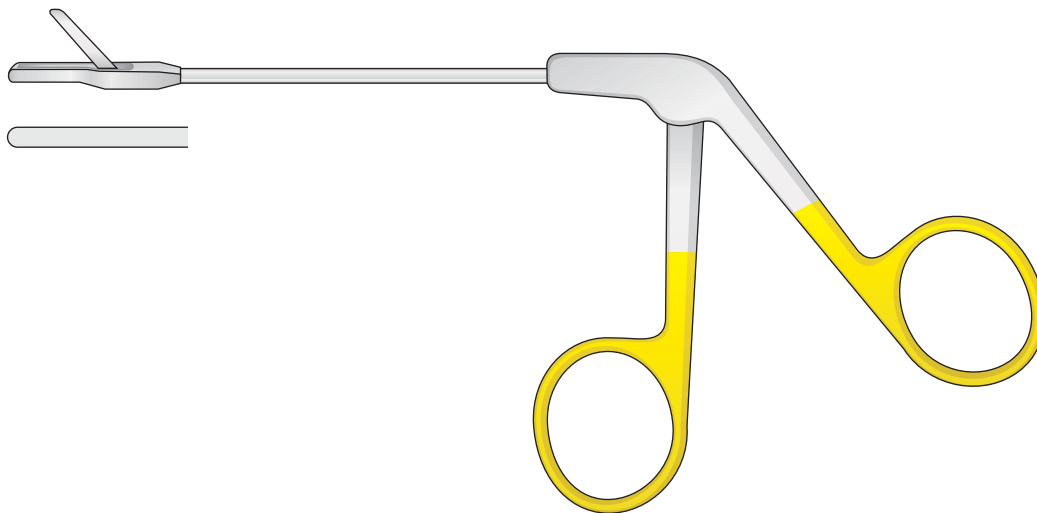

STRUYCKEN
FF-17

130 mm

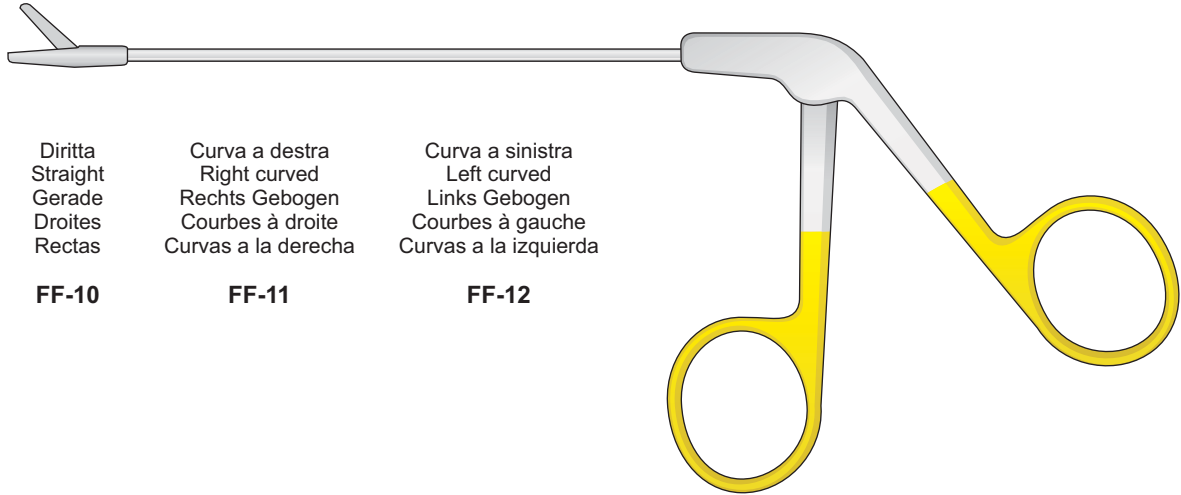

Diritta
Straight
Gerade
Droites
Rectas

FF-10

Curva a destra
Right curved
Rechts Gebogen
Courbes à droite
Curvas a la derecha

FF-11

Curva a sinistra
Left curved
Links Gebogen
Courbes à gauche
Curvas a la izquierda

FF-12

FF-10/FF-12

140 mm

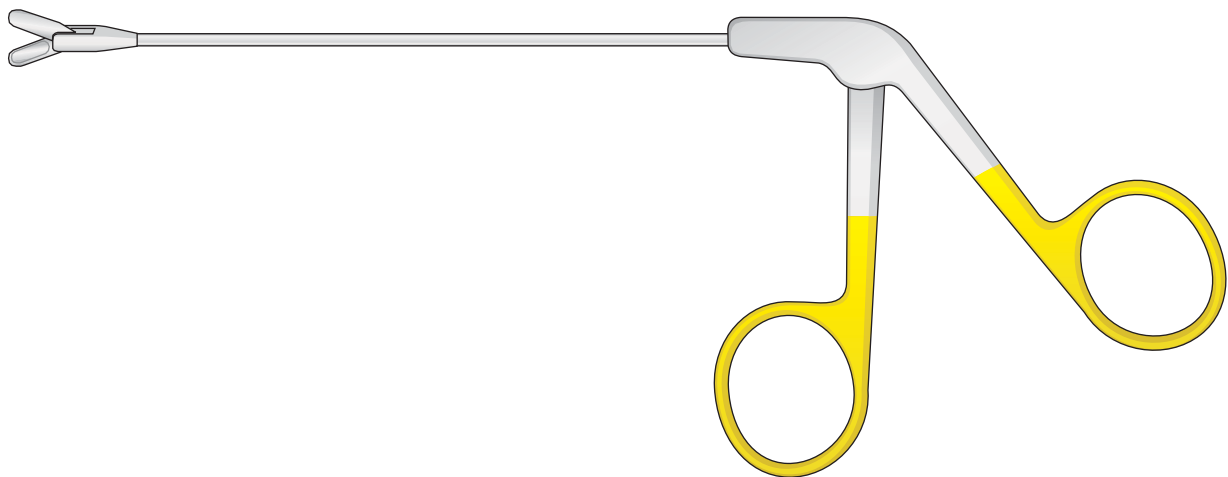

FF-13

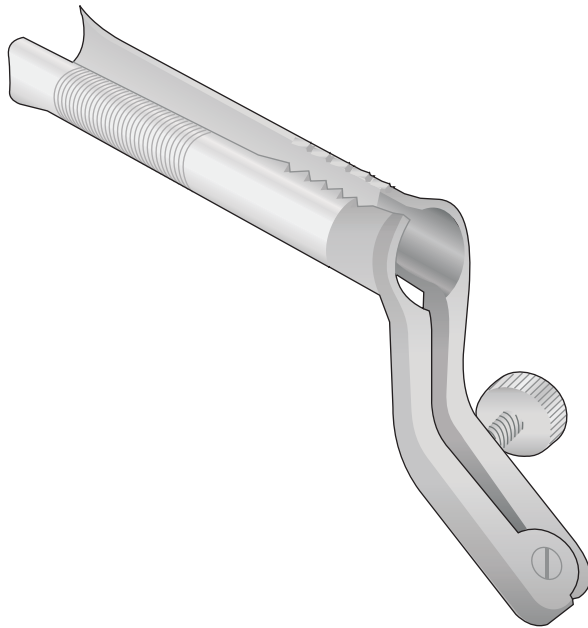

PAPAVERO-CASPAR
FF-214 80 x 11 mm
FF-215 90 x 13 mm
FF-216 100 x 15 mm

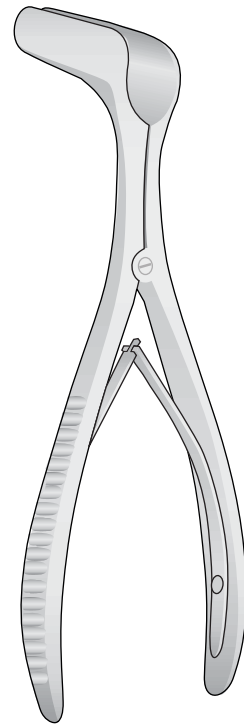

PAPAVERO-HARTMANN
OM-39
140 mm

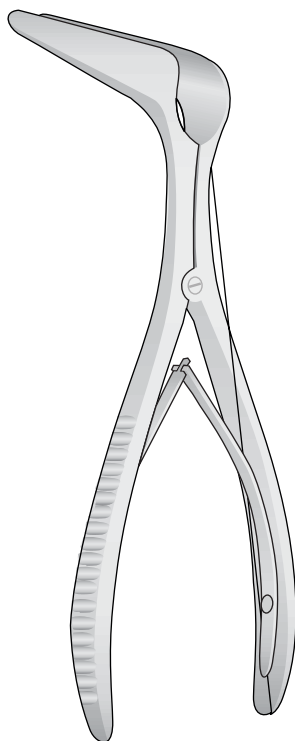

COTTLE
OM-25/OM-29
150 mm

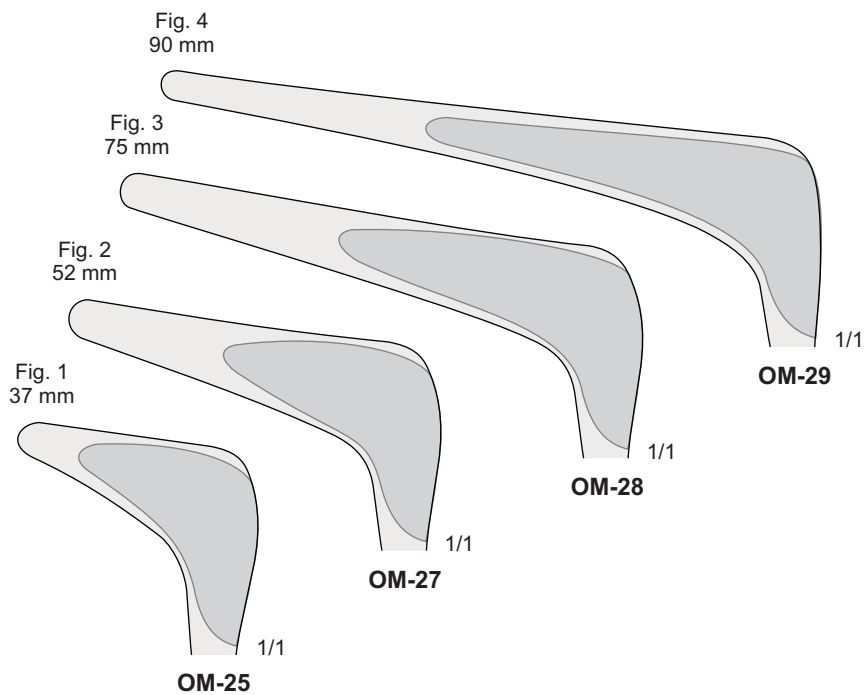

Speculum nasali
Nasal specula
Nasen Spekula
Spéculums nasaux
Espéculos nasales

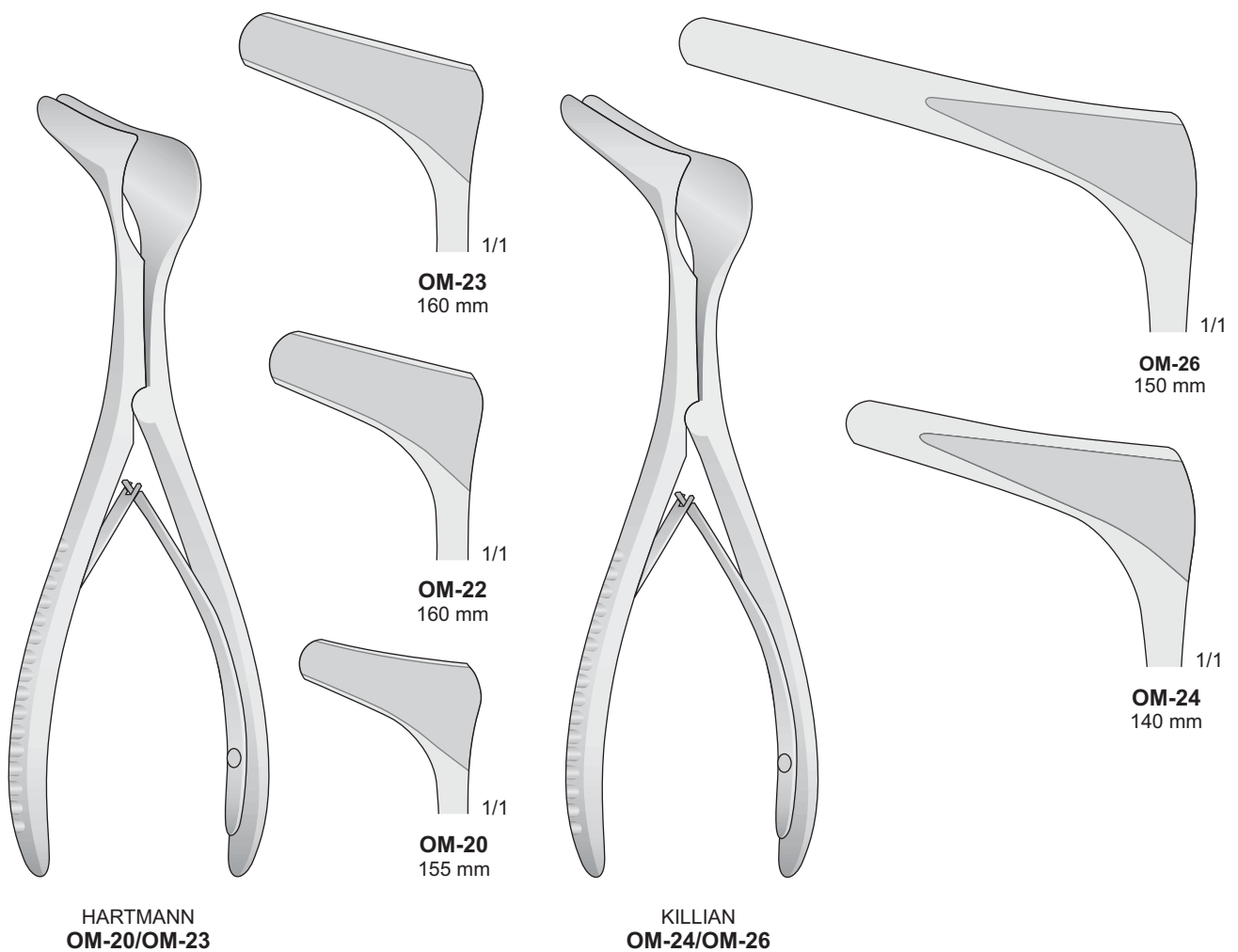

Speculum nasali
 Nasal specula
 Nasen Spekula
 Spéculums nasaux
 Espéculos nasales

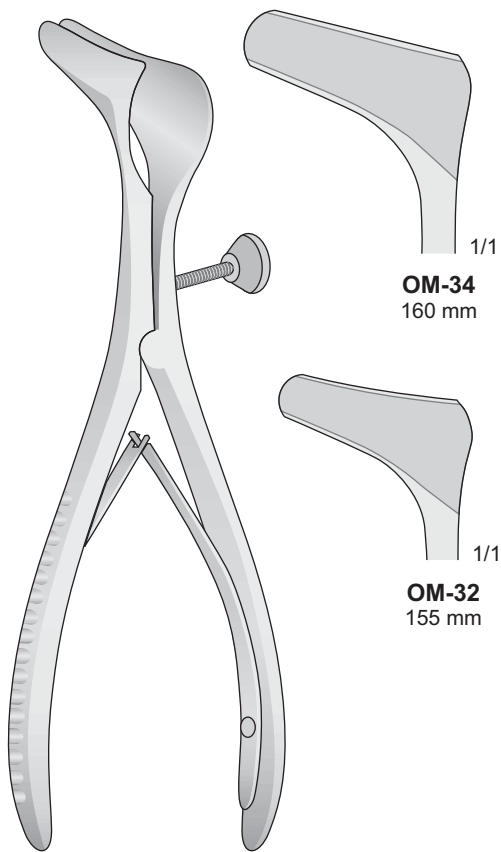

HARTMANN
 OM-32/OM-34

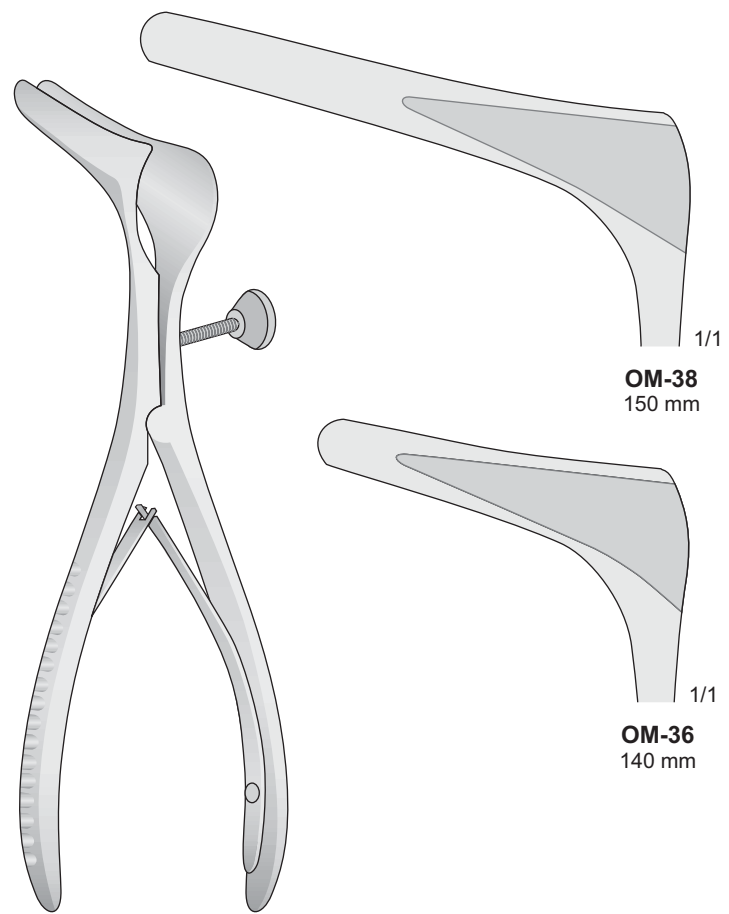

KILLIAN
 OM-36/OM-38

Pinza serranodi
Ear polypus snares
Polypenschnürer
Serre noeuds
Polipòtomos

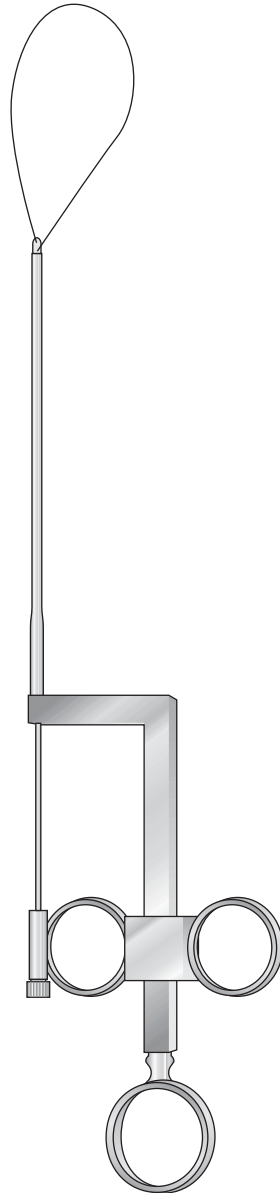

WILDE
DO-16
240 mm

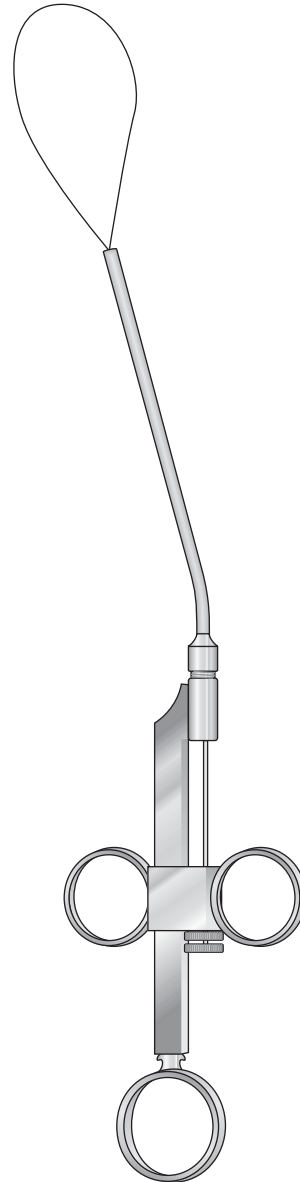

KRAUSE
DO-17
260 mm

14

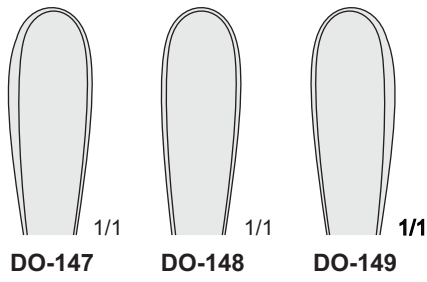
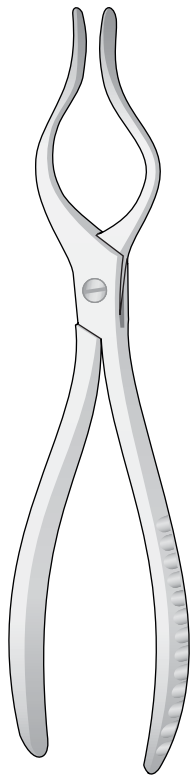

COTTLE-WALSHAM
DO-147/DO-149
230 mm

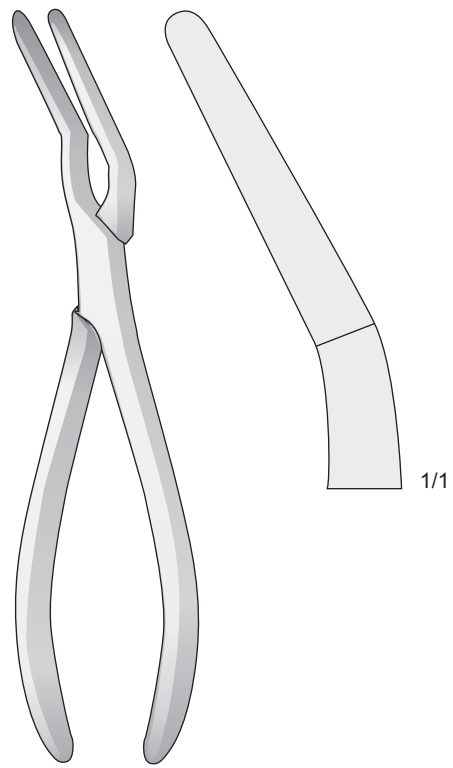

ASH
DO-157
230 mm

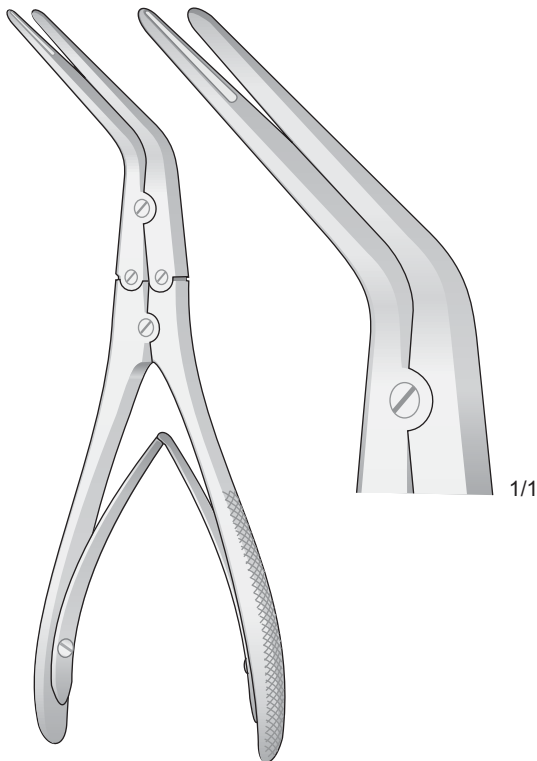

KRESSNER
FO-141
200 mm

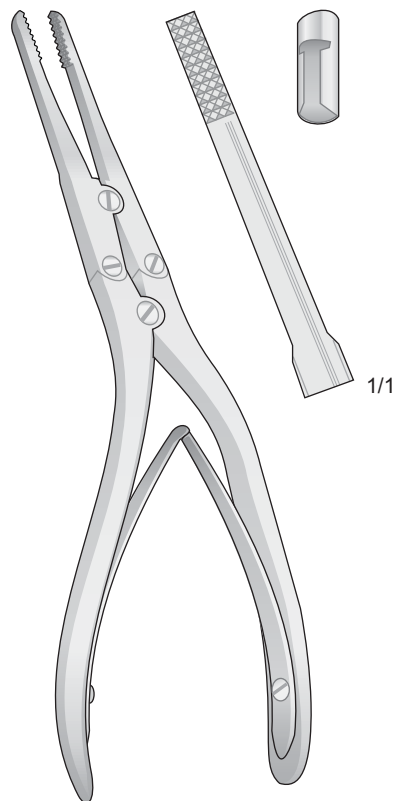

RUBIN
FO-142
210 mm

Strumento per rotture e asportazione frammenti ossei e cartilagine
 Bone crusher
 Knochen-Knorpelquetsche
 Instrument à écraser le cartilage
 Instrumento para magullar carilagos

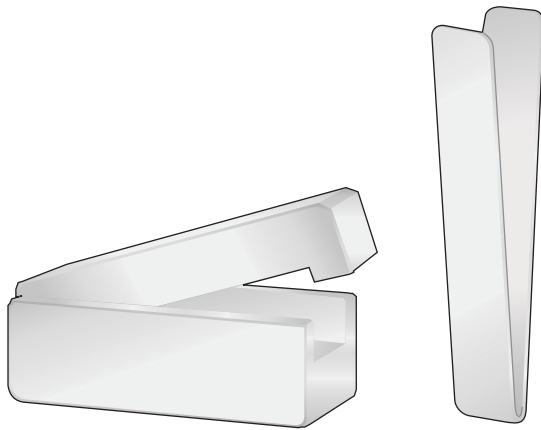

COTTLE
DO-264

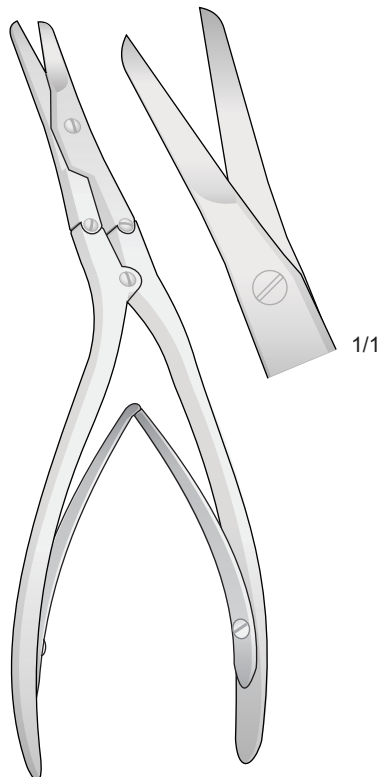

CAPLAN
FO-144
200 mm

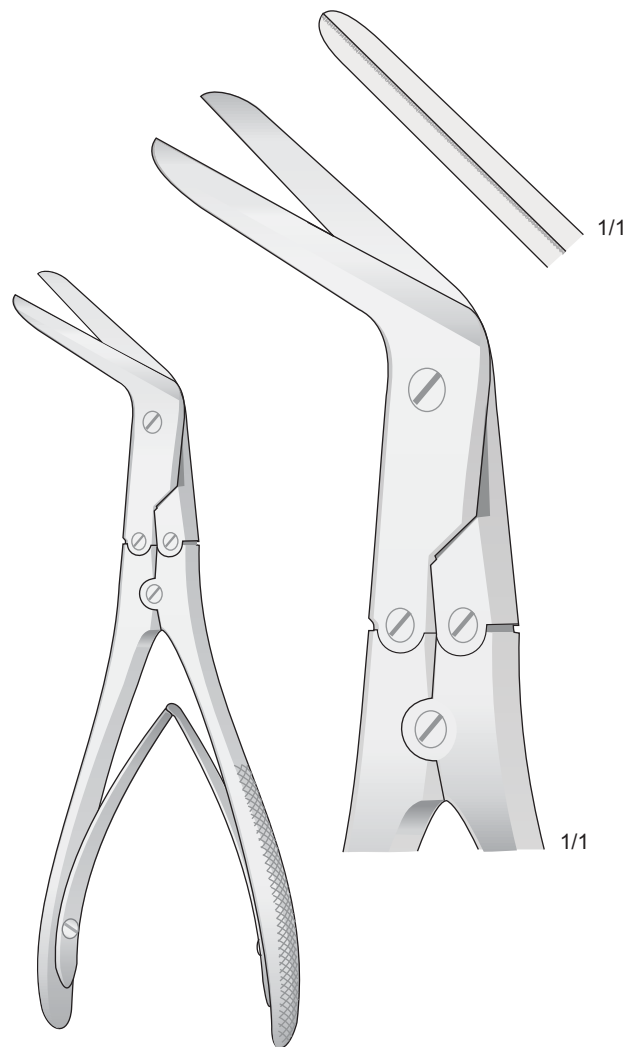

KILLIAN
FO-143
210 mm

Acuto/Smusso - Sharp/Blunt
Spitz/Stumpf - Pointu/Mousse
Agudas/Romas

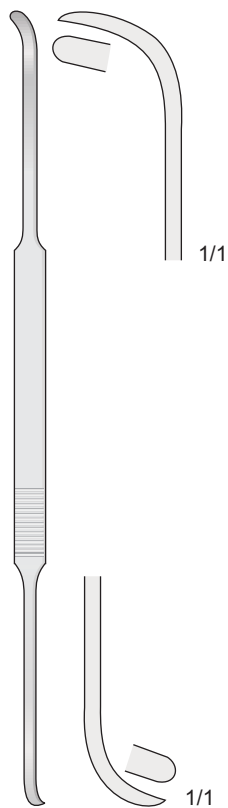

**COTTLE
KO-12**
230 mm

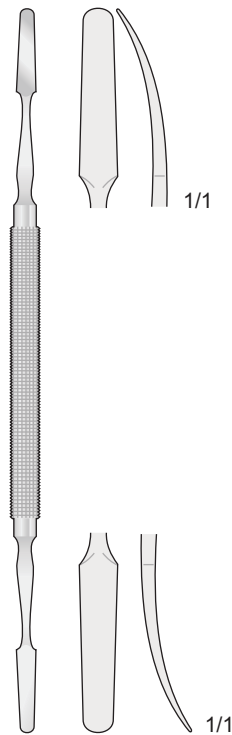

**KILIAN
KO-11**
180 mm

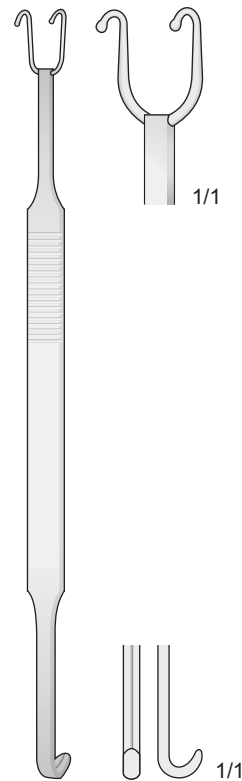

**COTTLE-NEIVERT
BT-57**
200 mm

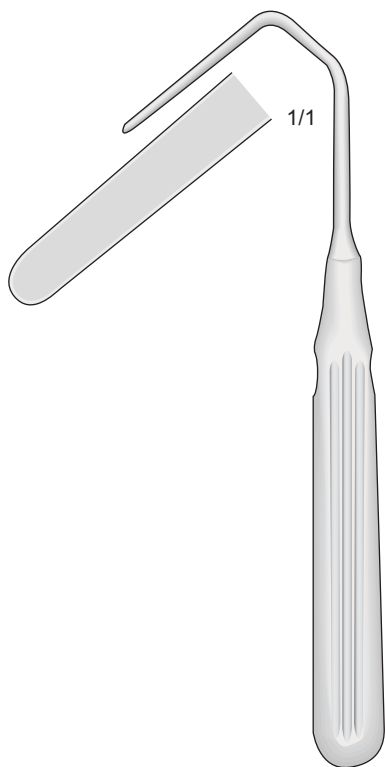

**AUFRICHT
DO-48**
175 mm

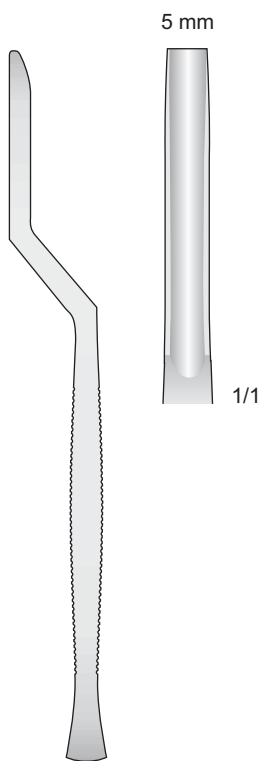

**KILIAN
DO-91**
160 mm

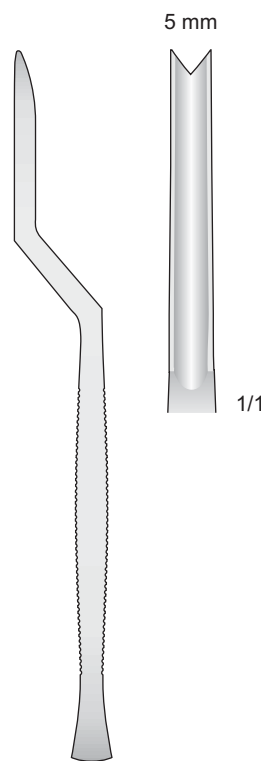

**KILIAN-KLAUS
DO-92**
160 mm

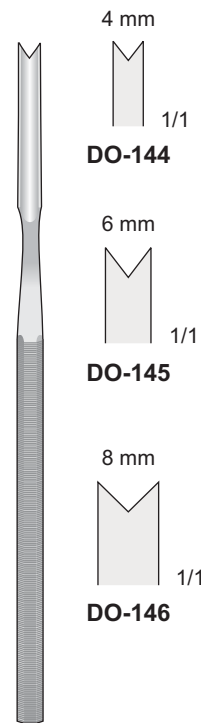

**BALLENGER
DO-144/DO-145/DO-146**
150 mm

Diritta
Straight
Gerade
Droites
Rectas



SILVER
DO-34
180 mm

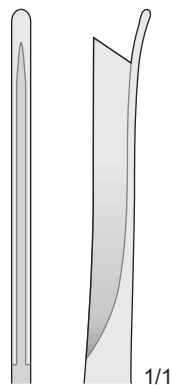

Curva, sinistra
Curved, left
Gebogen, links
Courbes à gauche
Curvas a la izquierda



SILVER
DO-35
180 mm

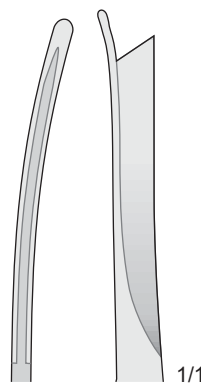

Curva, destra
Curved, right
Gebogen, rechts
Courbes à droite
Curvas a la derecha



SILVER
DO-36
180 mm

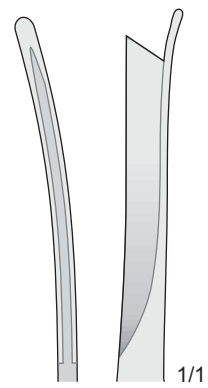

14

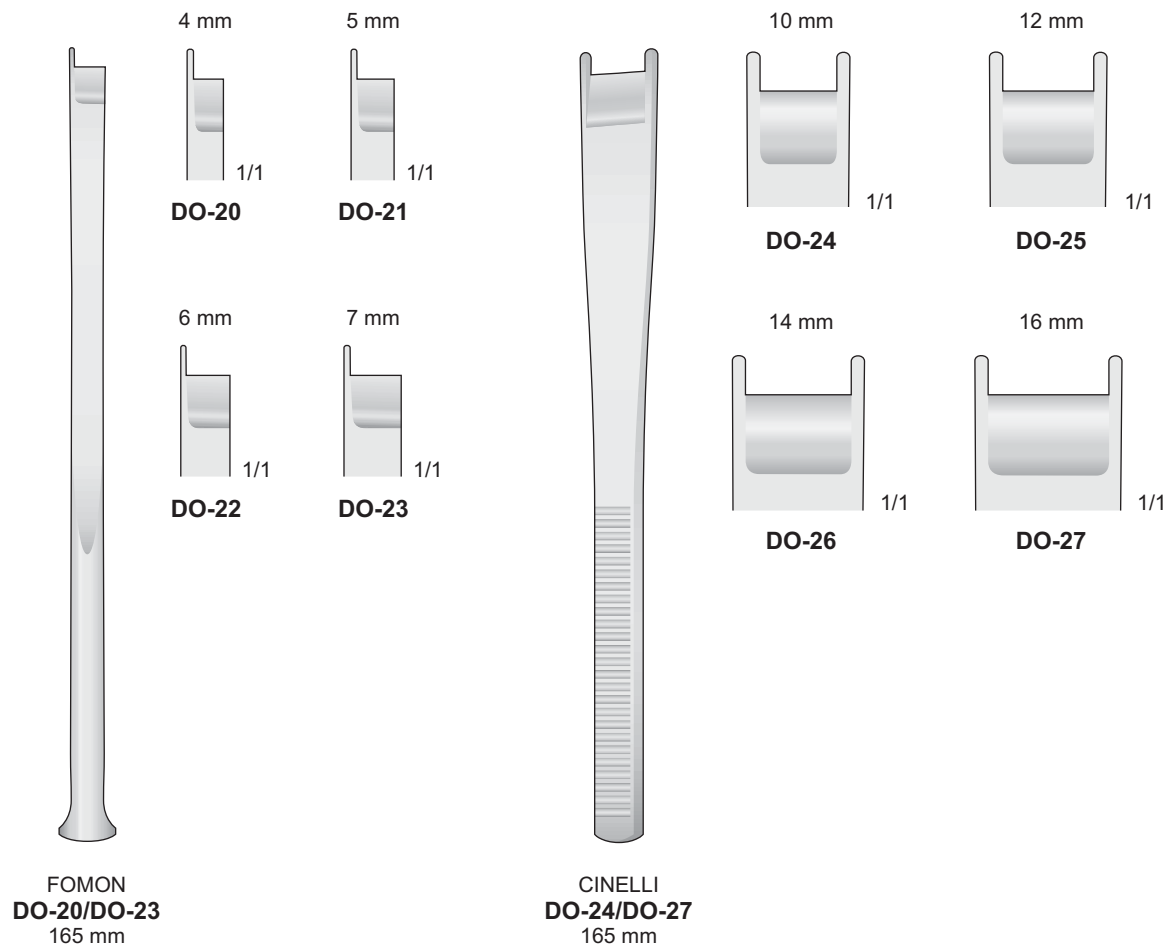



Fig. 67

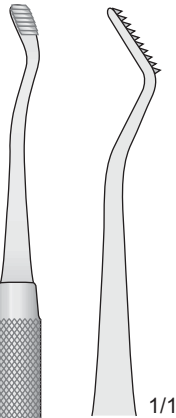

Fig. 45

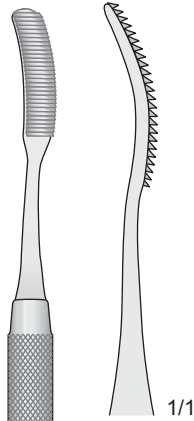
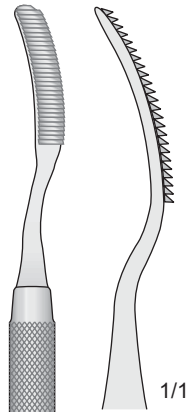

Fig. 52



8 mm



8 mm
FK-96
210 mm

**HOWARD
DO-1**
180 mm

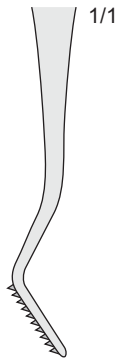

2 mm



5 mm
FK-97
210 mm

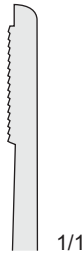

1/1

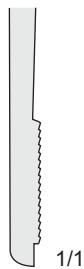

1/1

**MILLER
DO-2**
185 mm

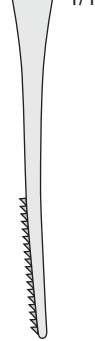

1/1

8 mm



8 mm
FK-98
210 mm

**MILLER
DO-3**
180 mm

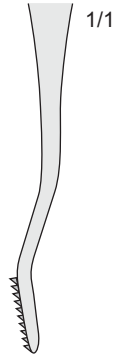

1/1

8 mm



8 mm
FK-99
210 mm

14



6,5 mm



FOMON
DO-168
210 mm

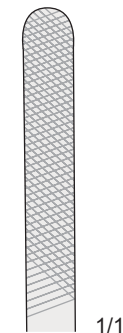

1/1

6,5 mm



FOMON
DO-169
210 mm

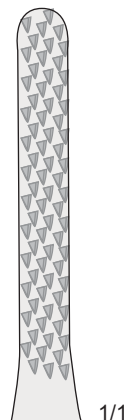

1/1

Bisturi per mucosa
Mucous knife
Mukosamesser



FREER
FR-18
165 mm

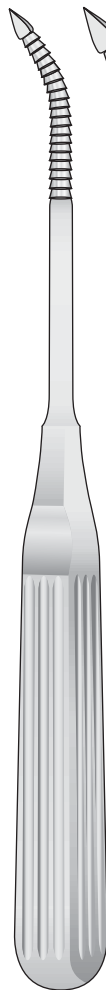

LEWIS
DO-77
180 mm

1/1

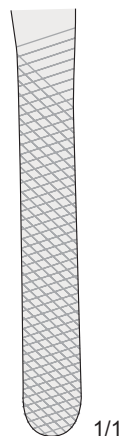

1/1

7,5 mm

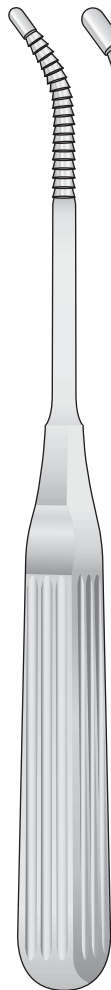

LEWIS
DO-78
180 mm

1/1

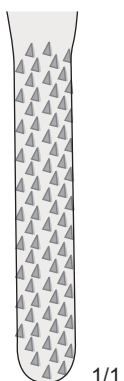

1/1

7,5 mm

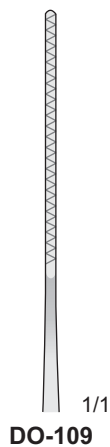

DO-109

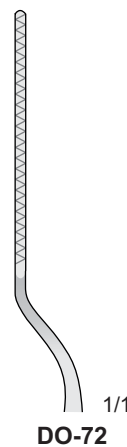

DO-72



DO-87



JOSEPH
DO-72/DO-109
190 mm



MALTZ
DO-179
180 mm

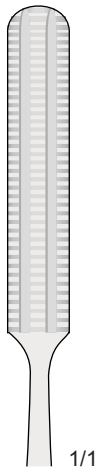

1/1

Uncino per arco zigomato
Zigoma hook
Haken-Jochbogenahle

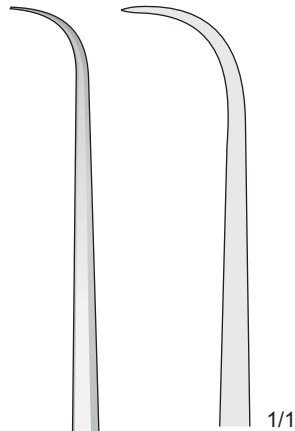

JOSEPH
DO-73/DO-74
135 mm

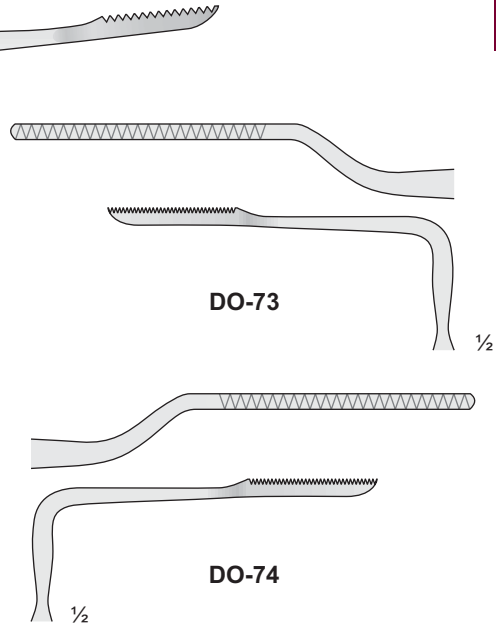

DO-73

DO-74

Curette taglienti
Scharfe Küretten
Curettes Tranchantes



Fig. 1
DO-285



Fig. 2
DO-286

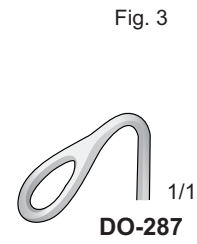

Fig. 3
DO-287



Fig. 4
DO-88



Fig. 5
DO-89



Fig. 6
DO-290

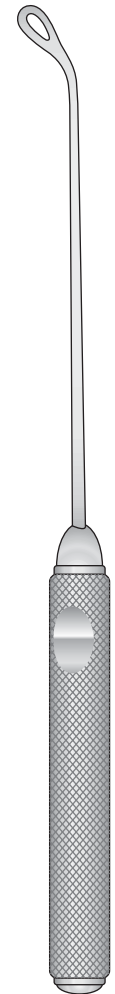

COAKLEY
DO-285/DO-290
170 mm

DO-274
200 mm

Adenotomi - Adenotomie - Adenoidectomy
Adénoïdes - Adenoides

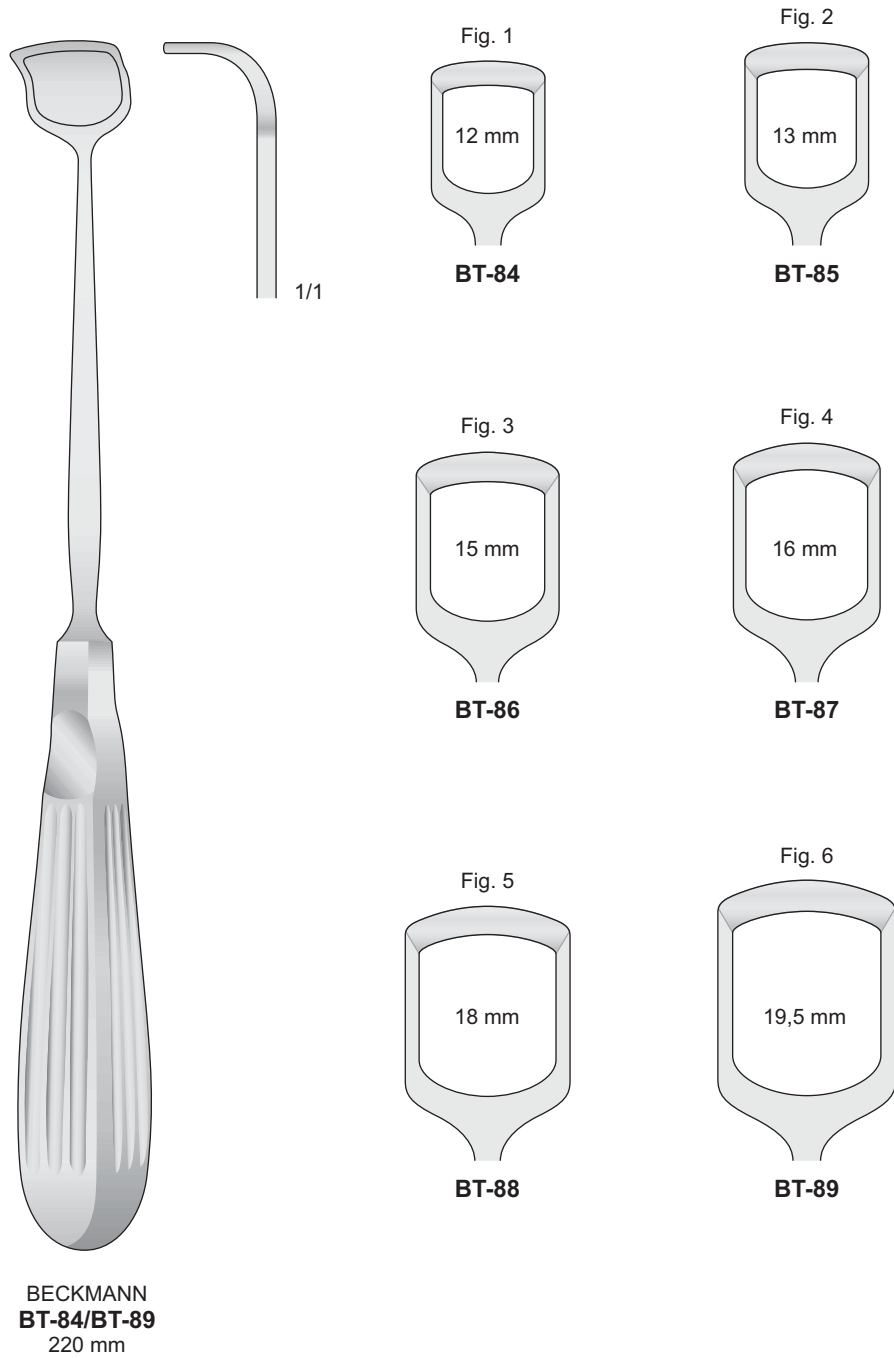



DO-118
200 mm



DO-119
200 mm

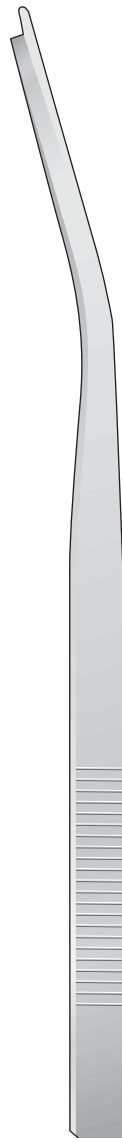

DO-84
200 mm



DO-85
200 mm

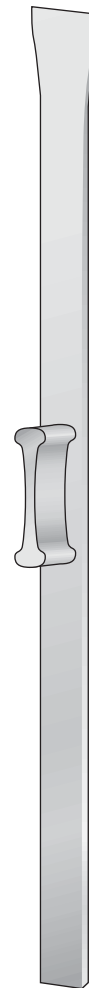

RUBIN
DO-170/DO-172
180 mm

Osteotomi, Osteotomes
Osteotome, Ostéotomes, Osteótomos



DO-170
10 mm



DO-171
12 mm



DO-172
14 mm

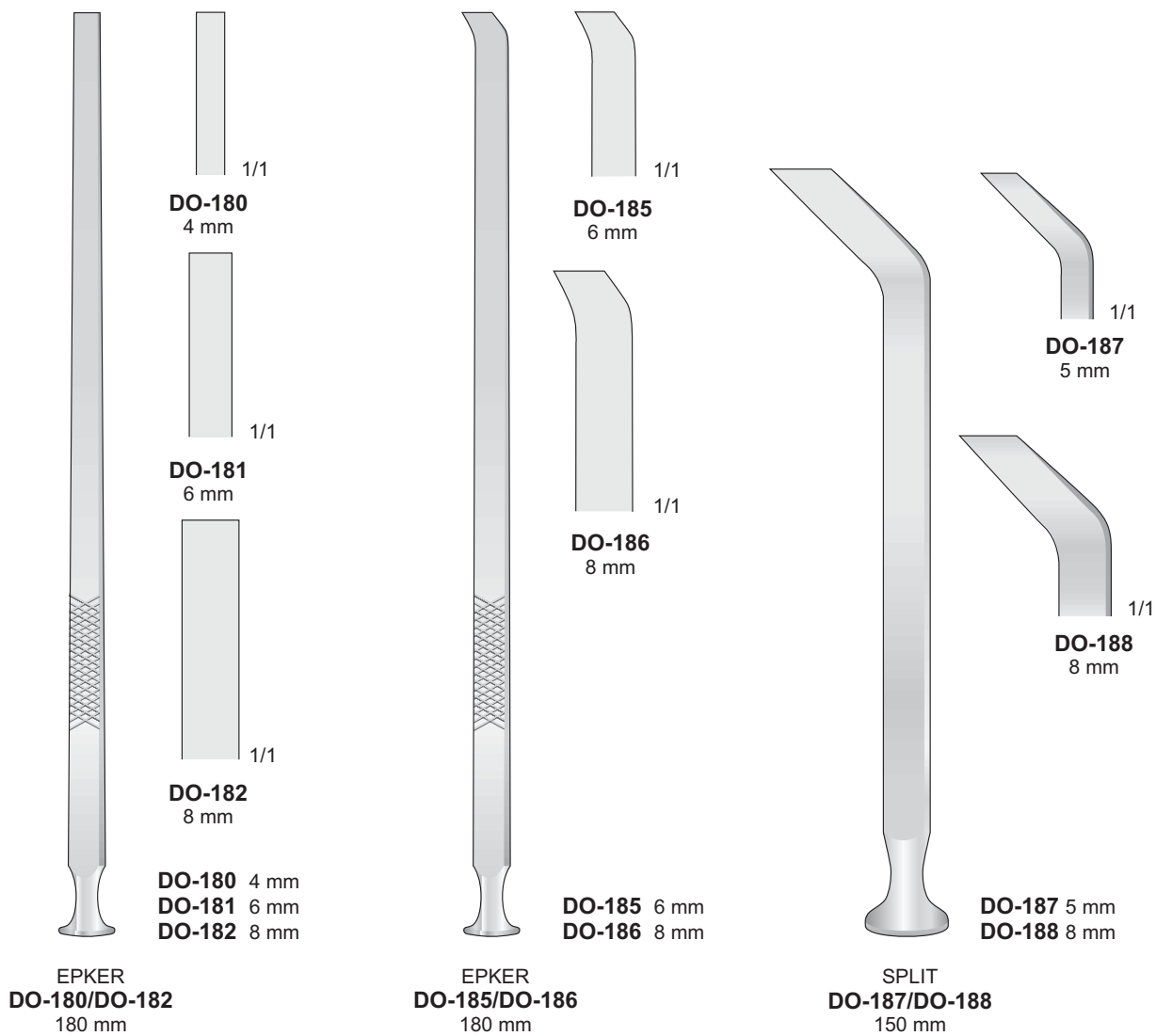

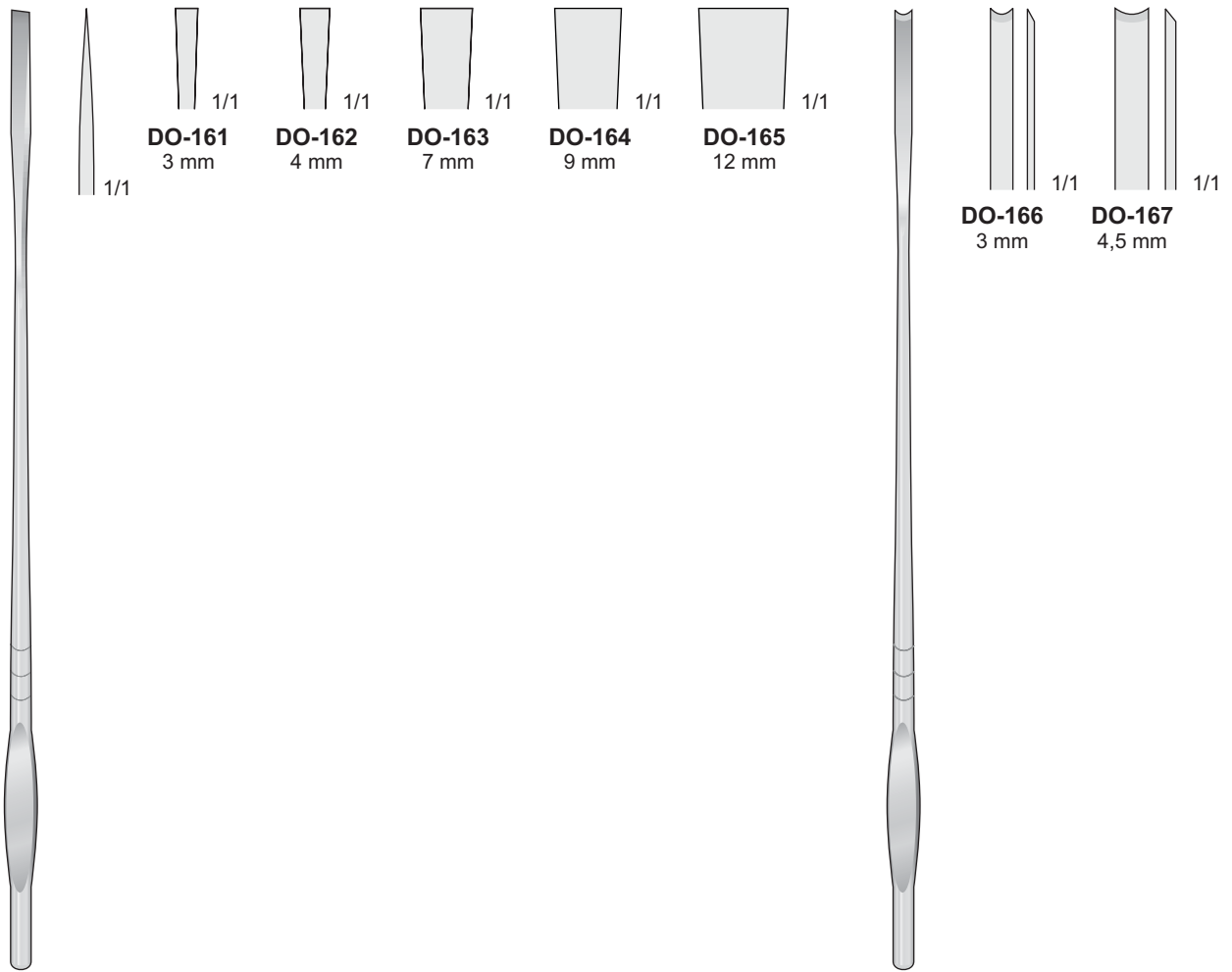

DO-161/DO-163
190 mm

DO-166/DO-167
190 mm

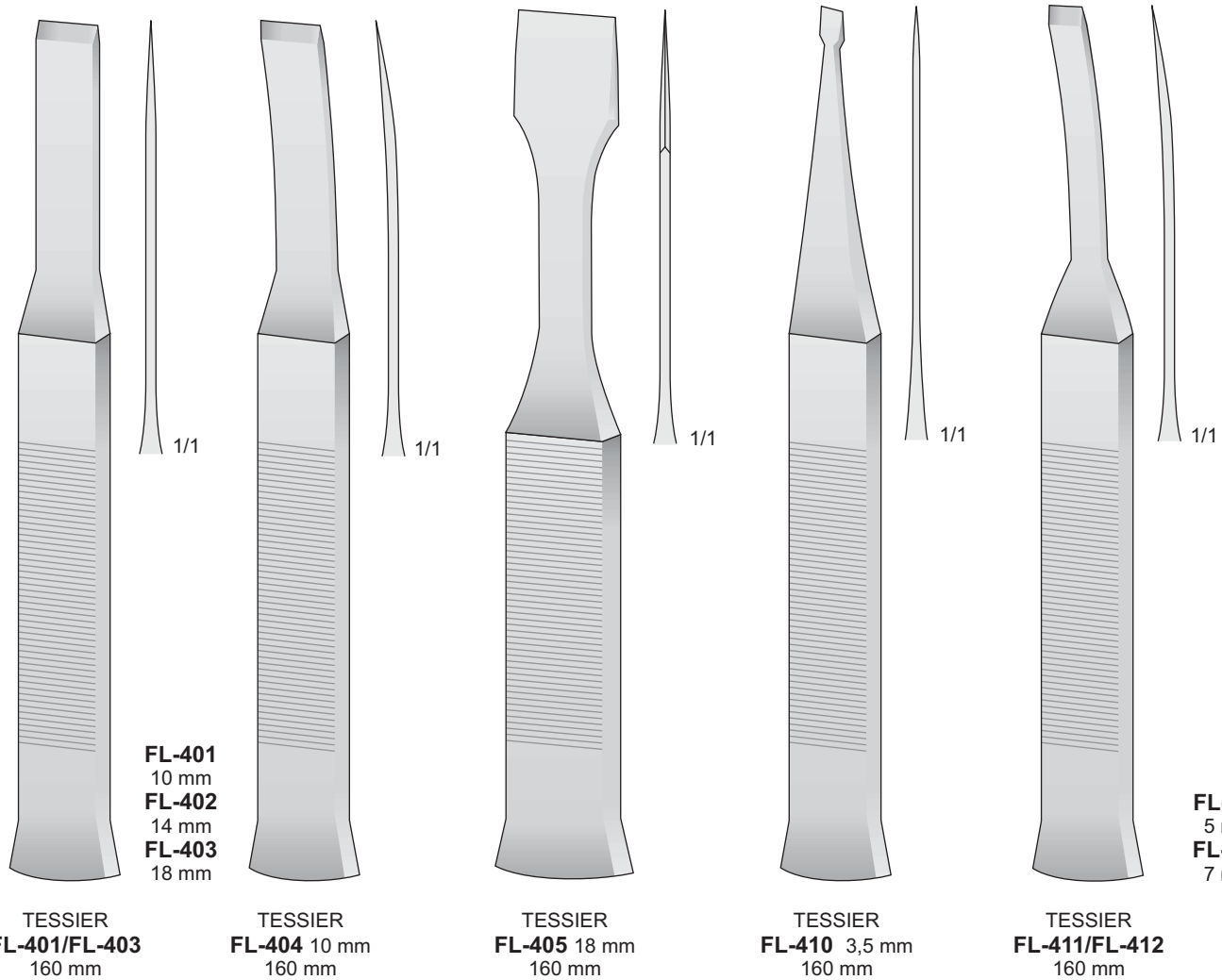

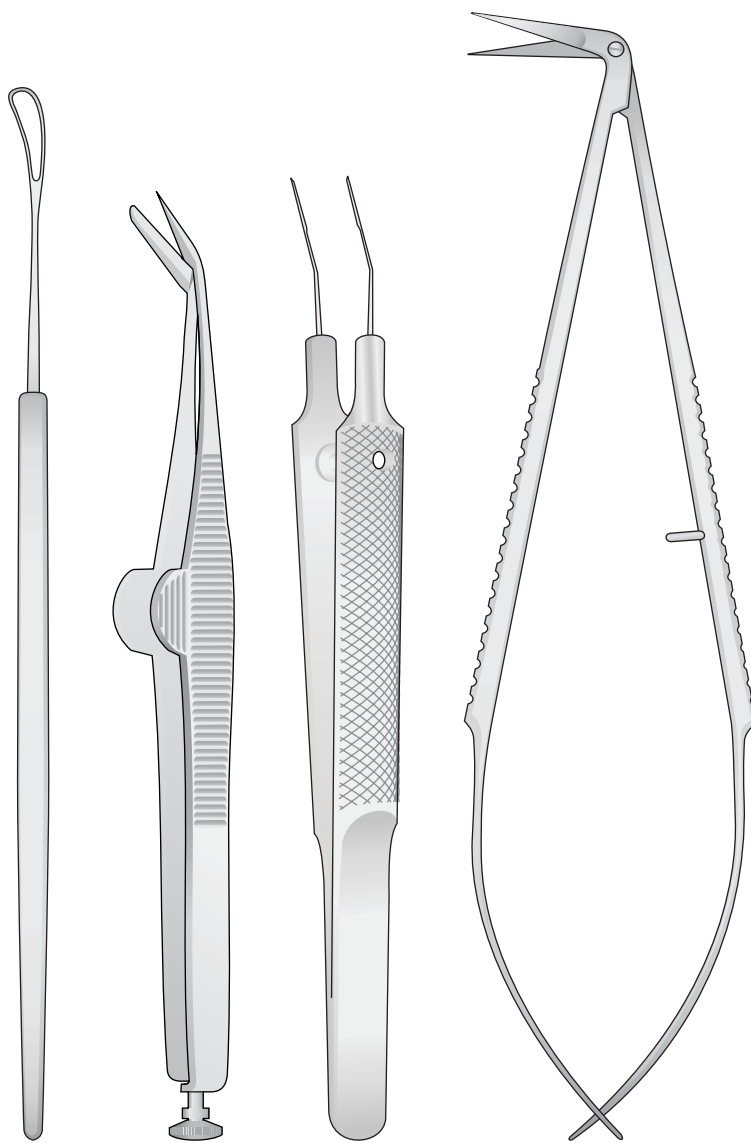

15 |

Ophthalmology
Ophthalmologie
Oftalmologia
Ofthalmologia

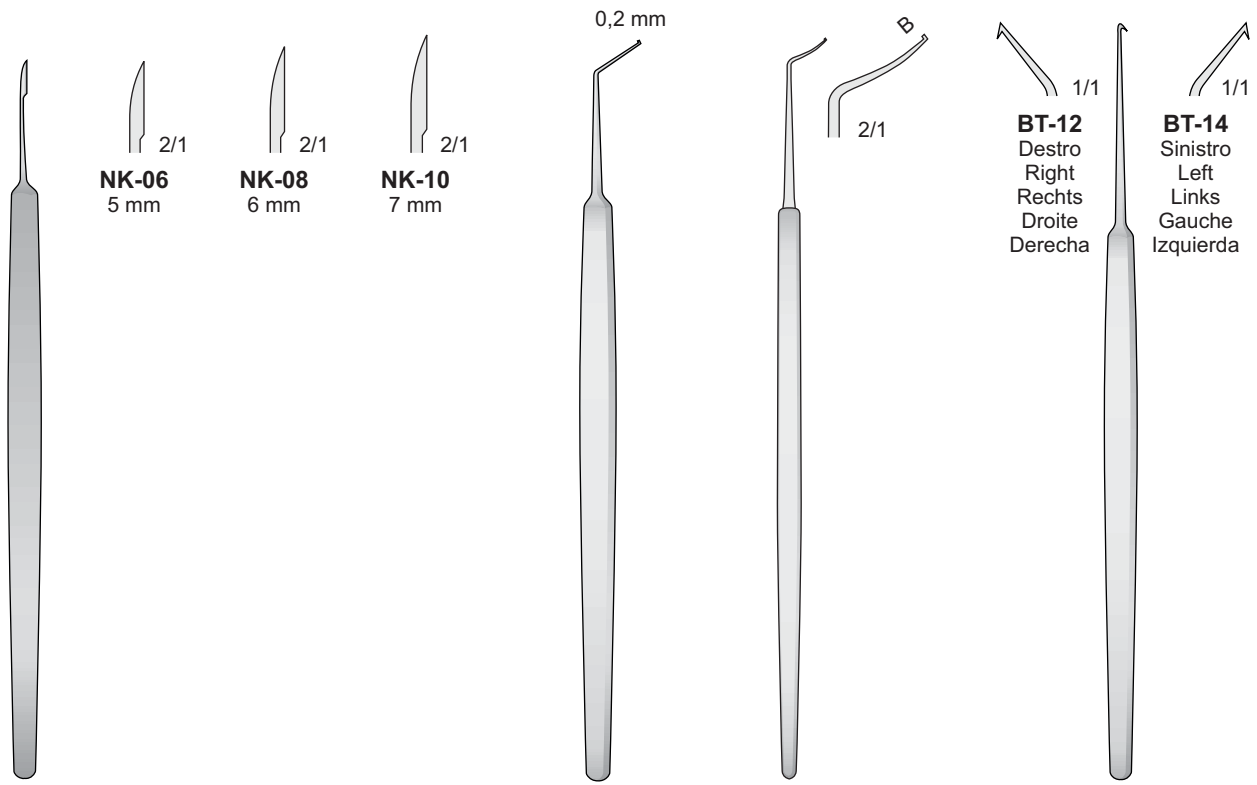

ZIEGLER
NK-06/NK-10
115 mm

NK-93
120 mm

B
NK-74 0,2 mm
NK-76 0,3 mm
125 mm

GRAEFE
BT-10
130 mm

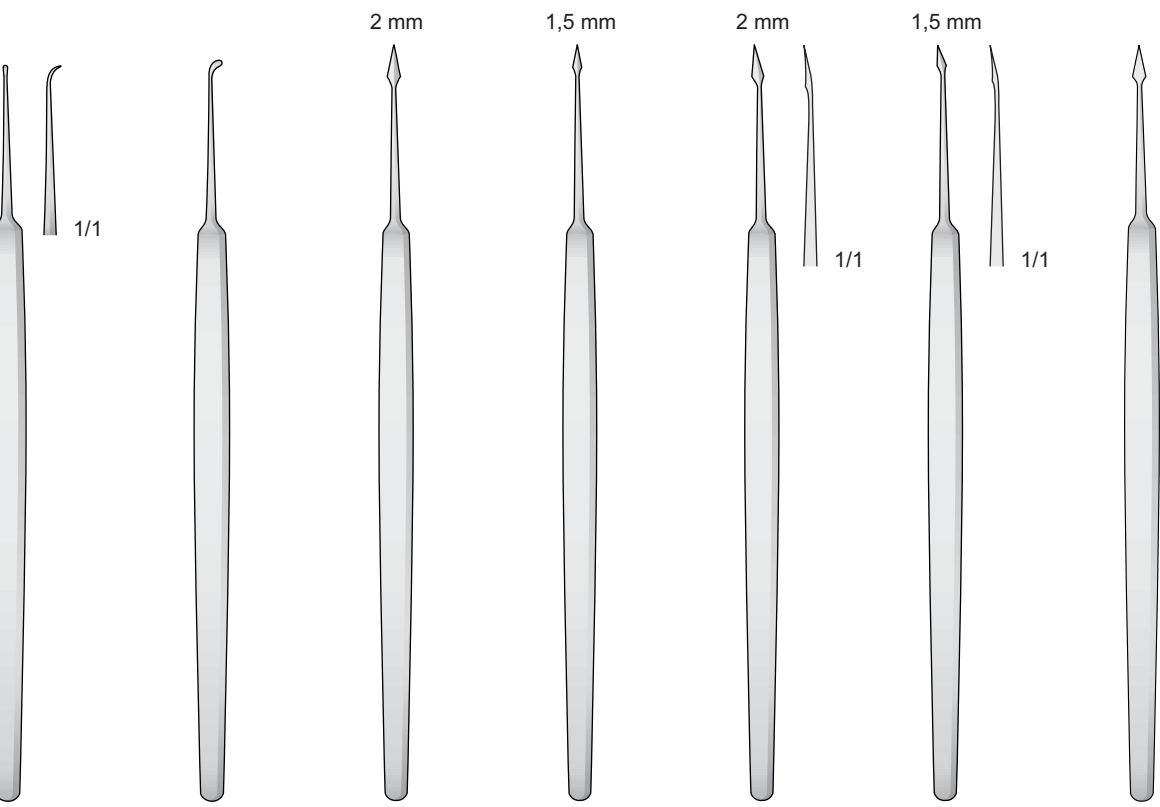

LA FORCE
NK-07
120 mm

ELLIS
NK-09
120 mm

NK-39
125 mm

NK-19
125 mm

NK-17
125 mm

NK-15
125 mm

NK-49
125 mm



NK-11
125 mm



NK-13
120 mm



GRAEFE
NK-18/NK-20
140 mm

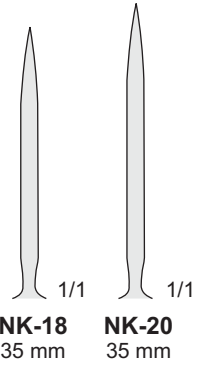

GRAEFE
NK-14/NK-16

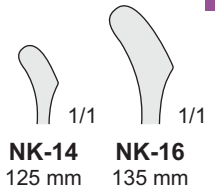

1/1

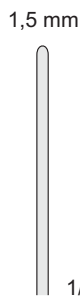

1,5 mm
1/1
NK-27

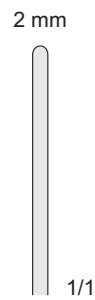

2 mm
1/1
NK-28

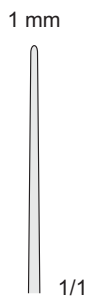

1 mm
1/1
NK-29
Convergente
Convergent
Konvergent



GRAEFE
NK-41/NK-43
130 mm

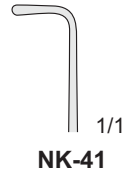

1/1
NK-41

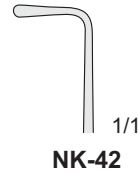

1/1
NK-42



1/1
NK-43

WECKER
NK-27/NK-29
130 mm



NK-21
130 mm

NK-22
130 mm

NK-23
130 mm

NK-24
130 mm

NK-25
130 mm

NK-26
130 mm

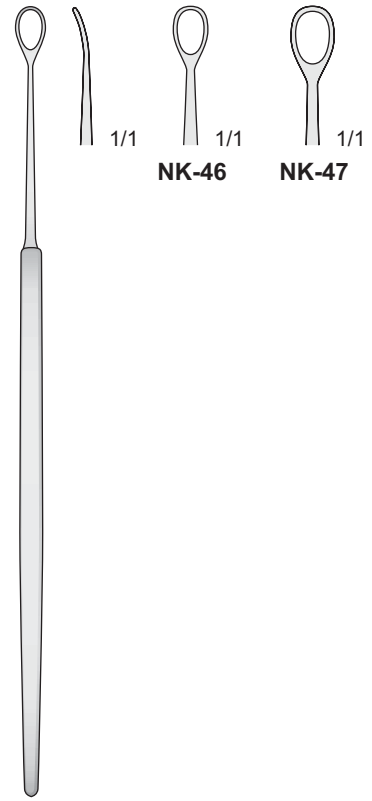

NK-46

NK-47

CASTROVIEJO
NK-21/NK-26

WEBER
NK-46/NK-47
135 mm

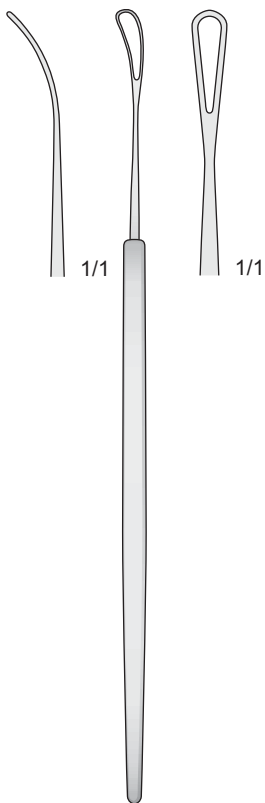

NK-03
Sinistro
Left
Links
Gauche
Izquierda

NK-04
Destro
Right
Rechts
Droite
Derecha

4 mm
1/1

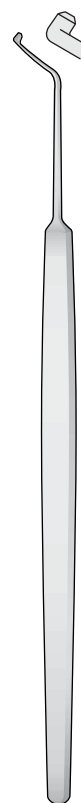

SNELLEN
NK-45
135 mm

NK-03/NK-04
140 mm

NK-44
130 mm

NK-75
130 mm

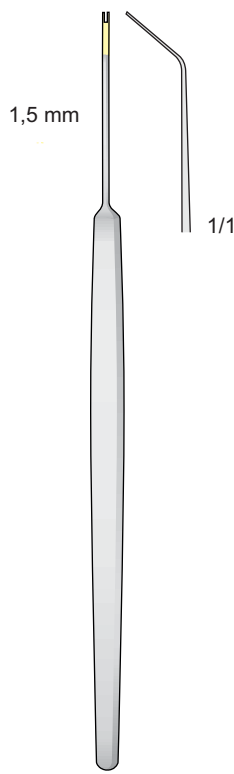

NK-109
130 mm

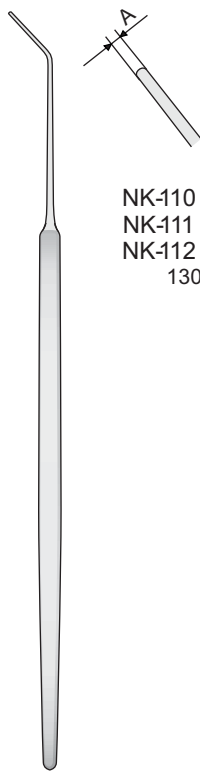

CASTROVIEJO
NK-110/NK-112
130 mm

A
NK-110 0,6 mm
NK-111 1,0 mm
NK-112 1,5 mm
130 mm



NK-05
140 mm



NK-94
165 mm



KIMURA
NK-48
150 mm

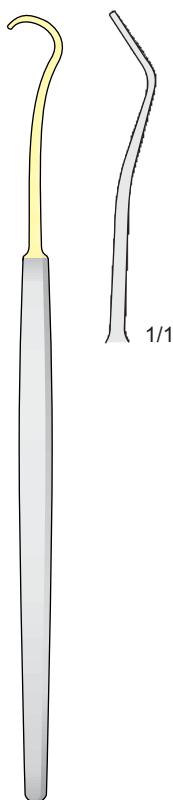

ARRUGA
NK-59
140 mm

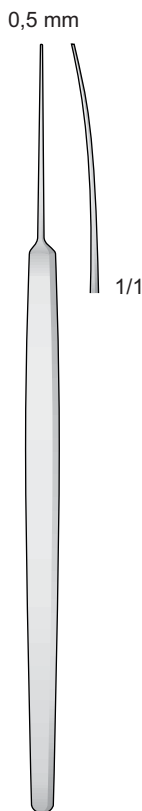

NK-107
130 mm

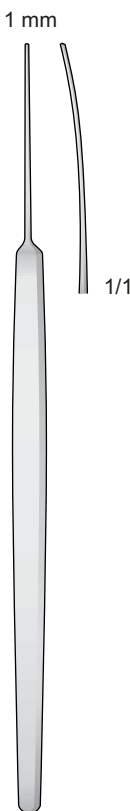

NK-108
130 mm

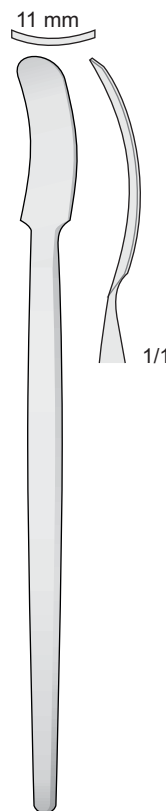

NK-105
125 mm

Dilatatori lacrimali
Tränenkanal Dilatatoren
Lacrymal dilators
Dilatadores lacrimales

Fig.1

Fig.2

Fig.3



WILDER
NK-97
100 mm



WILDER
NK-98
100 mm



WILDER
NK-99
100 mm

Linsenmanipulatoren
Lens manipulators
Manipolatori del IOL
Manipuladores de lentes
Micro-Manipulateurs d'implant

Irishaken 0,5 mm
Stumpf, Gebogen



JAFFE-KNOLLE
NK-340
120 mm

Linsenspatel 0,5 mm
Glatt, Flach, Gebogen



JAFFE
NK-341
120 mm

Kragen-Kopf
Polierer, Gerade

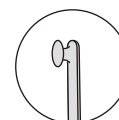

GRAEATHER
NK-342
120 mm

Kragen-Kopf
Polierer, Gebogen



GRAEATHER
NK-343
120 mm

Linsenrotierer
Stumpf, Gebogen



BECHERT
NK-344
120 mm

Irishaken 0,5 mm
Stumpf, Gerade



JAFFE-KNOLLE
NK-345
120 mm

Linsenspatel 0,5 mm
Breit, Flach, Gebogen

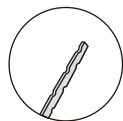

HIRSCHMANN
NK-346
115 mm

Linsenhaken
Gebogen



HIRSCHMANN
NK-347
120 mm

Linsenhaken 0,2 mm
Stumpf, Gerade

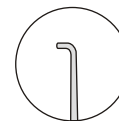

SINSKEY
NK-348
120 mm

Linsenhaken 0,2 mm
Stumpf, Gebogen



SINSKEY
NK-349
120 mm

Linsenhaken 0,25 mm
Stumpf, Gerade



LESTER
NK-350
115 mm

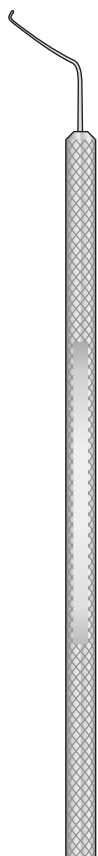

Lidpresser
Lid Expressor
Strumento per palpebra
Expressor de párpados
Expresseur de paupières

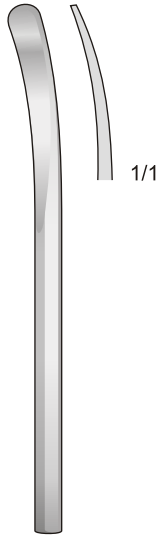

DS-08
90 mm

Lidplatte
Lid Plate
Placa per palpebre
Placa para párpados
Plaque à paupières

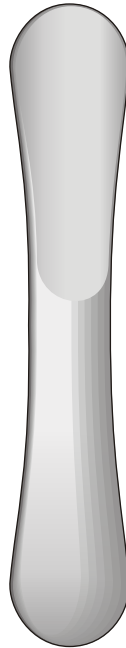

JAEGER
OM-09
110 mm

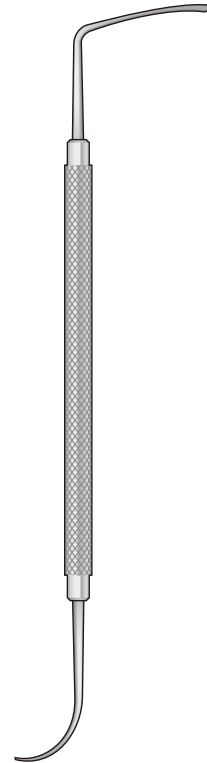

AMENABAR
NK-146

Markierungsgabel
Bi-Prong Marker
Forcelle per strabismo
Marcador bifurcado
Marquer Fourchette

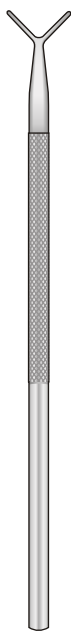

NK-450
100 mm



FINK
NK-142
90 mm

Lidhalter - Lid Retractor
Retrattore palpebrale - Retractor de párpados
Releveur de paupières

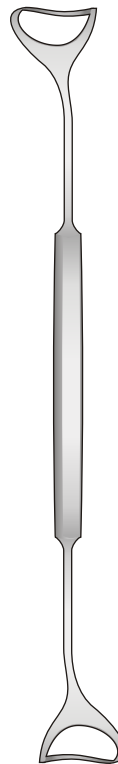

KLAR EVATEUR
BT-09
160 mm

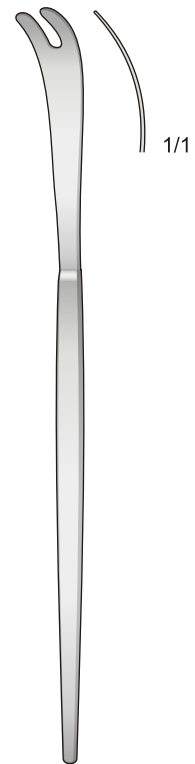

SCHEPENS
NK-143
155 mm

Micro Pinzette - Micro Forceps - Mikro Pinzetten - Micro pinces - Pinzas finos

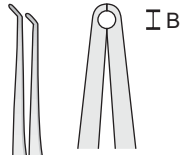

B
NK-61 0,2 mm
NK-62 0,3 mm
NK-63 0,4 mm

PIERSE
NK-61/NK-63
 80 mm

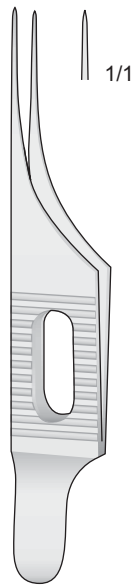

COLIBRI
NK-64
 80 mm



COLIBRI
NK-65/NK-67
 75 mm

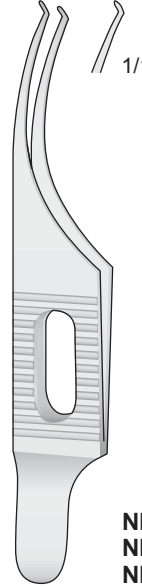

COLIBRI
NK-69/NK-71
 80 mm

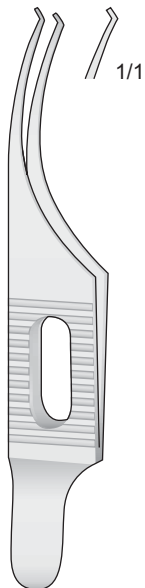

COLIBRI
NK-60
 80 mm

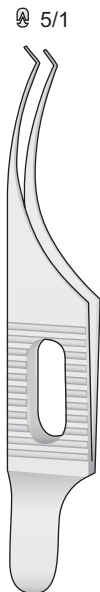

NK-73
 70 mm

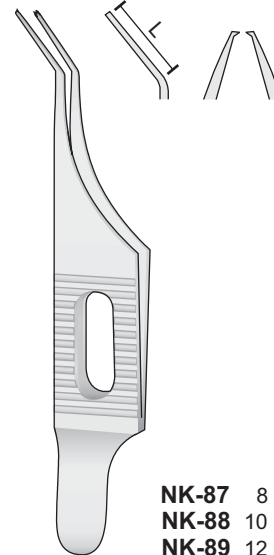

NK-87/NK-89
 70 mm

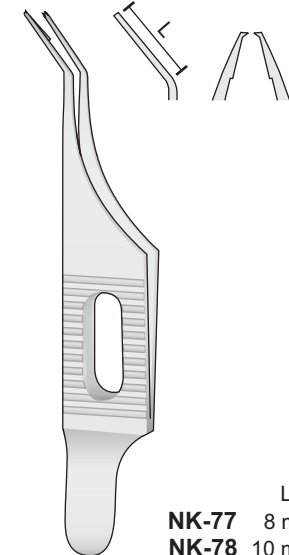

NK-77/NK-78
 70 mm

L
NK-87 8 mm
NK-88 10 mm
NK-89 12 mm

L
NK-77 8 mm
NK-78 10 mm

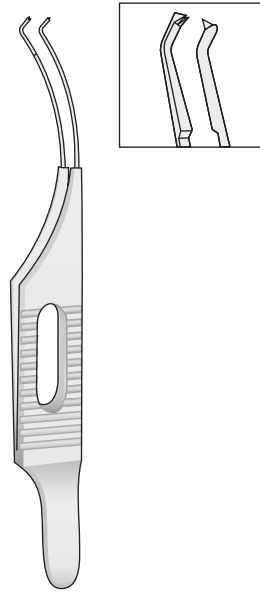

**BARRAQUER
NK-403**

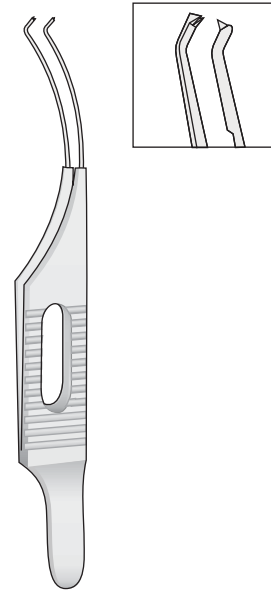

**BARRAQUER
NK-401**

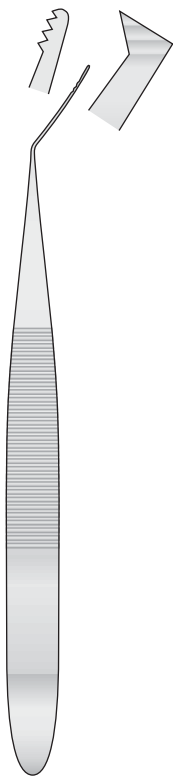

**FD-118
95 mm**

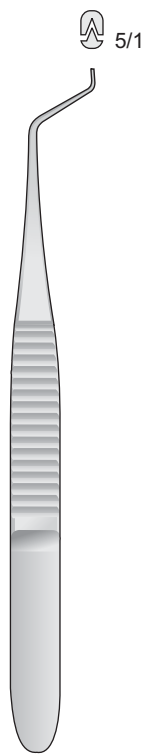

**FD-119
90 mm**

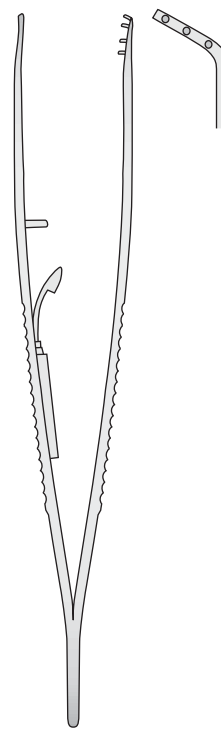

**FD-120
95 mm**

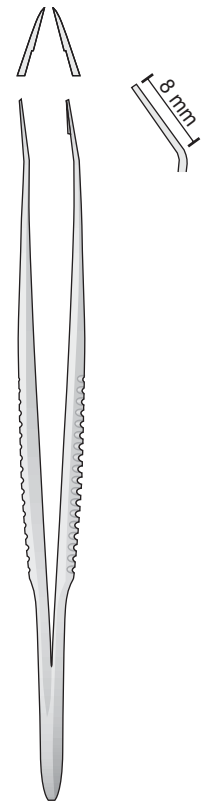

**Mc PHERSON
FD-123
95 mm**

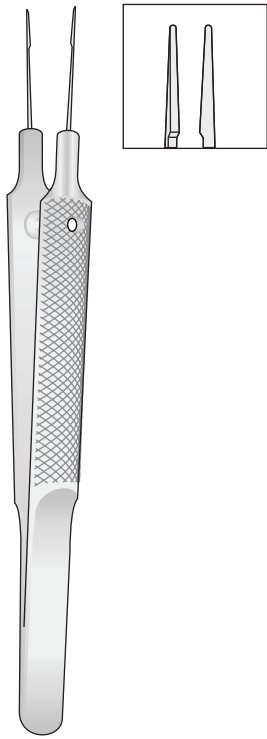

MF-150

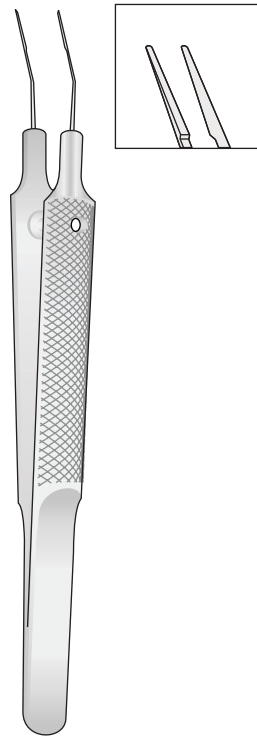

MF-151

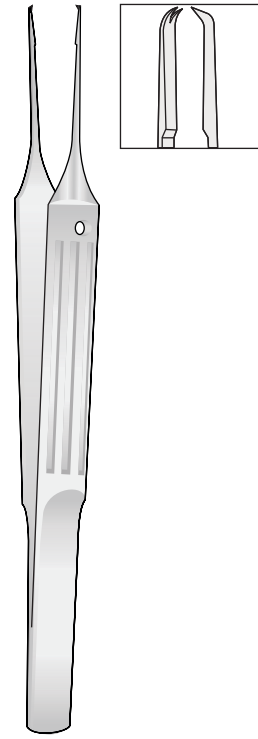

**CASTROVIEJO
MF-245**

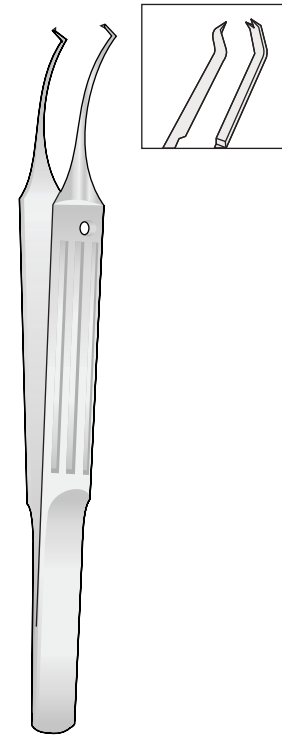

**TROUTMAN
MF-246**

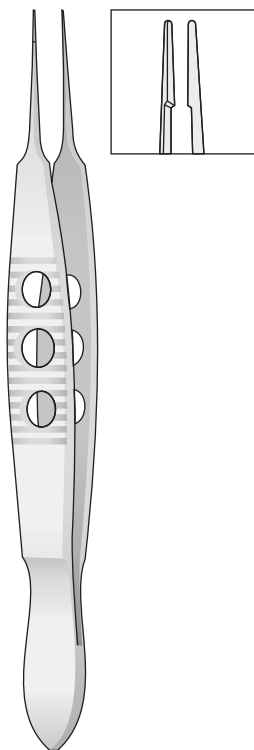

**MC PHERSON
MF-231**

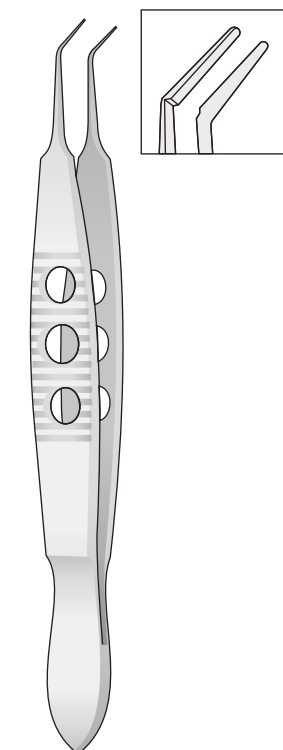

**MC PHERSON
MF-232**

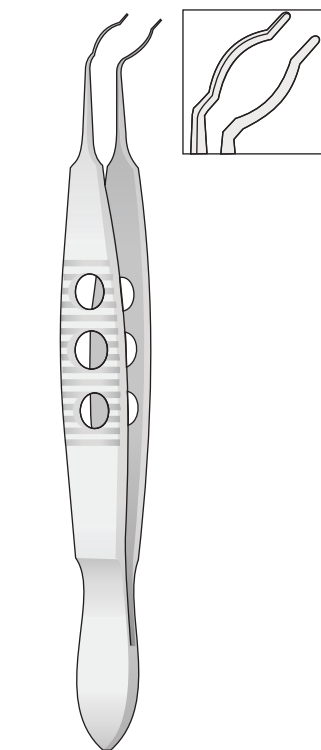

**OSHIKA-FAULKNER
MF-279**

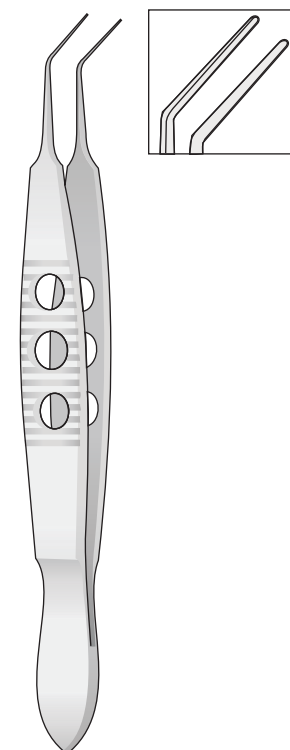

**FAULKNER
MF-278**

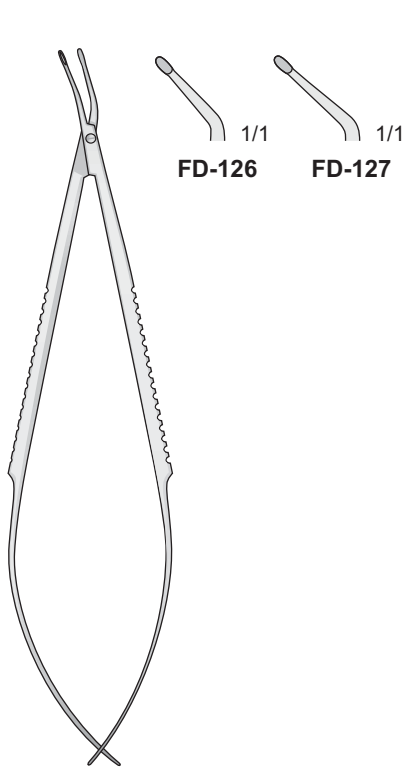

FD-126/FD-127
110 mm

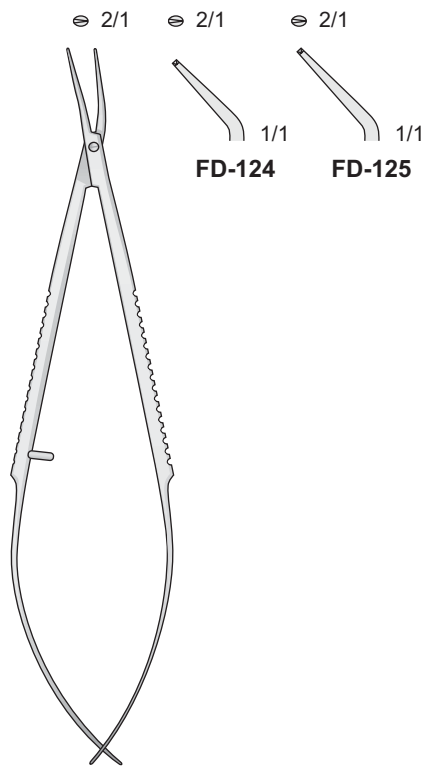

FD-124/FD-125
110 mm

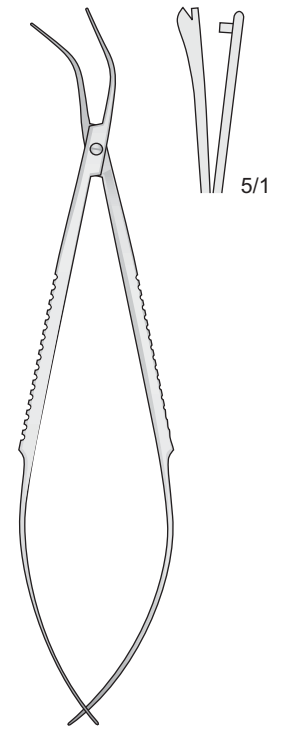

FD-130
110 mm

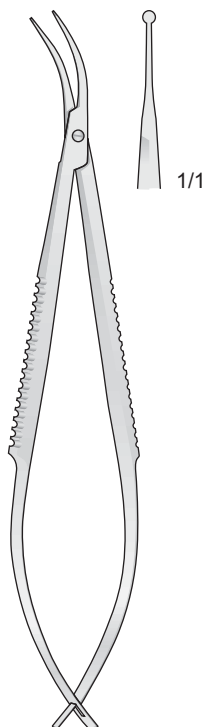

FD-132
110 mm

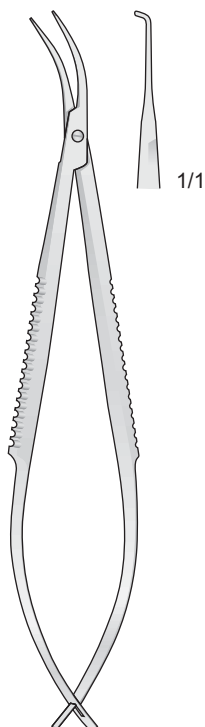

FD-134
110 mm

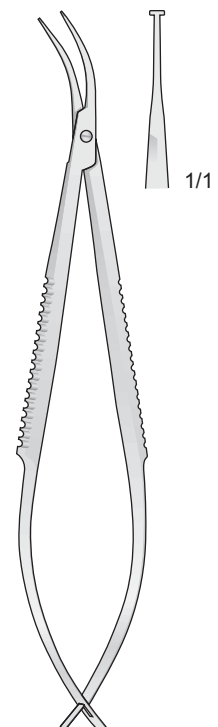

FD-136
110 mm

Blefarostati - Eye specula - Sperrelevatoren
Blépharostats - Blefarostatos

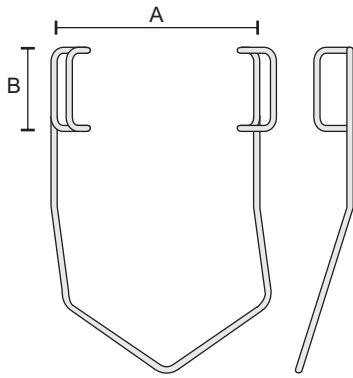

NK-79 A 27 mm B 11 mm

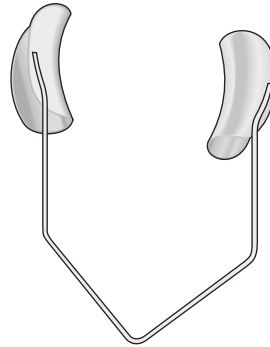

BARRAQUER NK-83

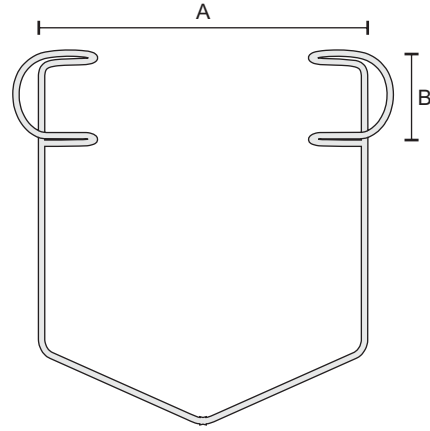

NK-80 A 27 mm B 5 mm
NK-82 34 mm 9 mm
NK-84 42 mm 12 mm
NK-86 42 mm 14 mm

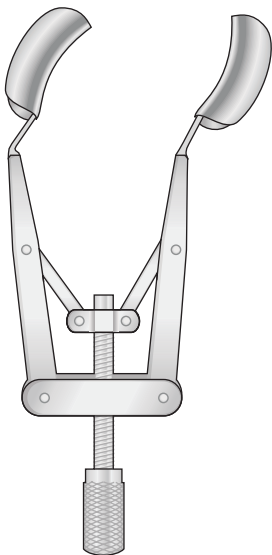

KERSHNER NK-420

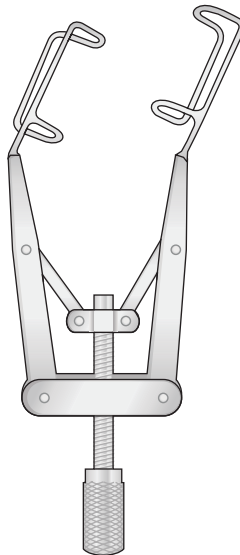

KERSHNER NK-421

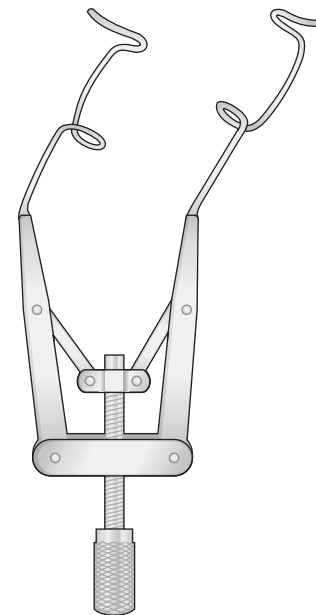

LIEBERMANN-TENNANT NK-422

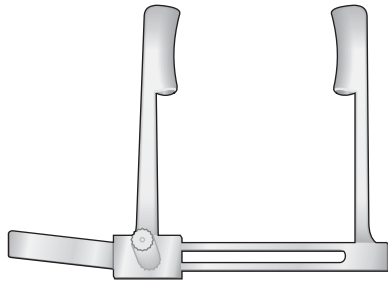

PROST
NK-92

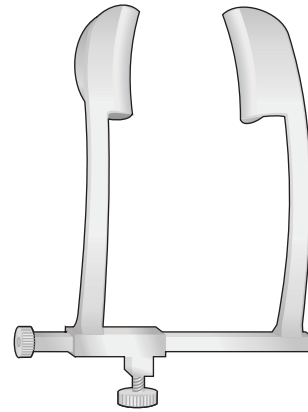

COOK
NK-131

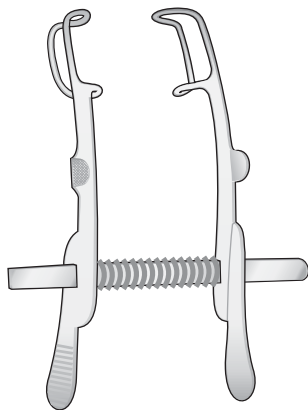

MELLINGER
BV-02
70 mm

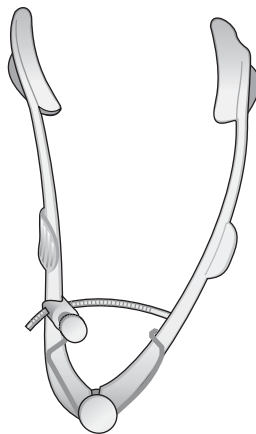

LISTER-BURCH
BV-04
80 mm

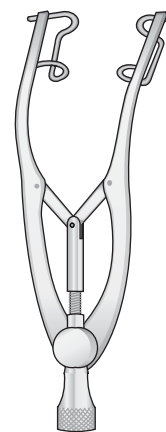

CASTROVIEJO
BV-05
80 mm

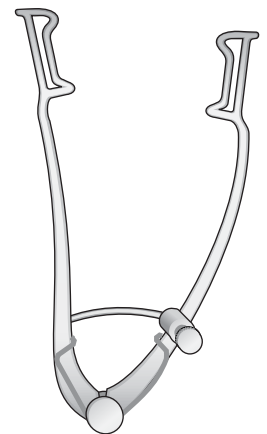

WILLIAMS
BV-06
80 mm

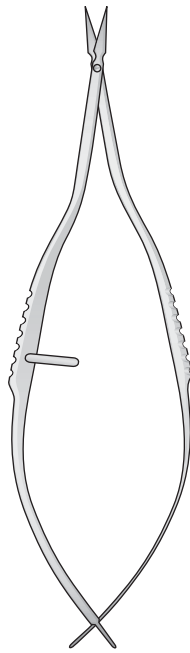

VANNAS
FD-79/FD-81
85 mm

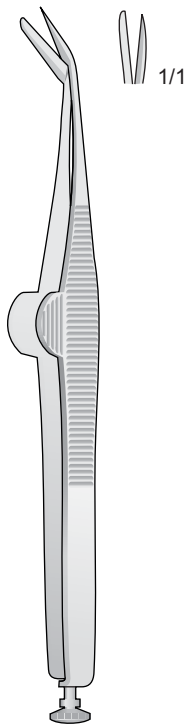

WECKER
FD-231
110 mm

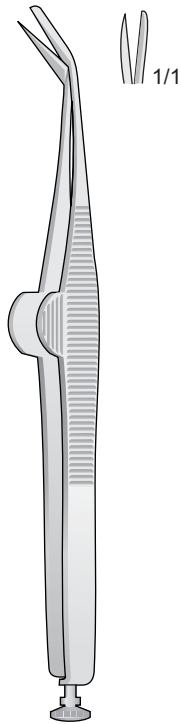

WECKER
FD-232
110 mm

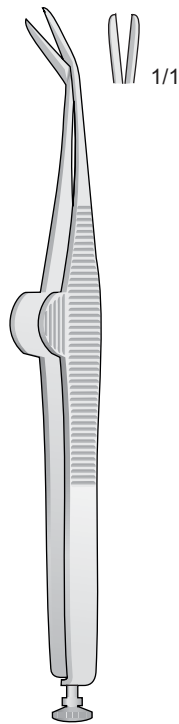

WECKER
FD-233
110 mm

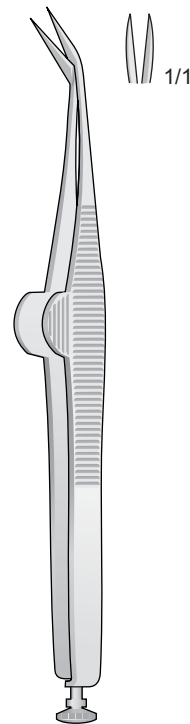

WECKER
FD-234
110 mm

Acuta - Sharp - Spitz
Pointu - Agudas

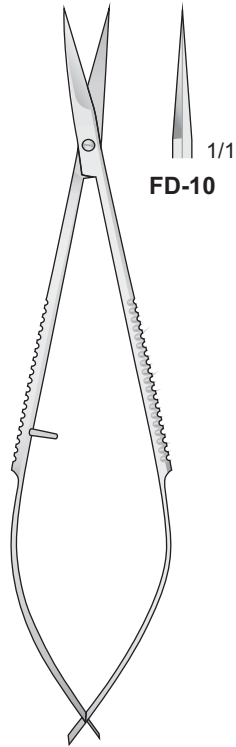

FD-10

**NOYES
FD-10
120 mm**

Acuta - Sharp - Spitz
Pointu - Agudas

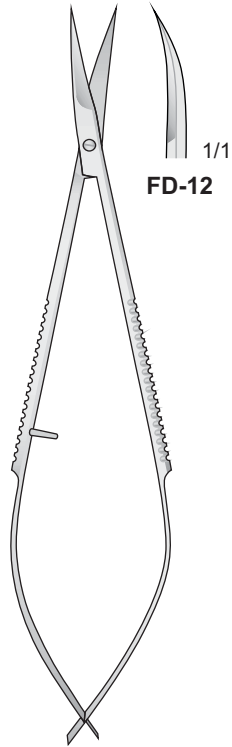

FD-12

**NOYES
FD-12
120 mm**

Acuta - Sharp - Spitz
Pointu - Agudas

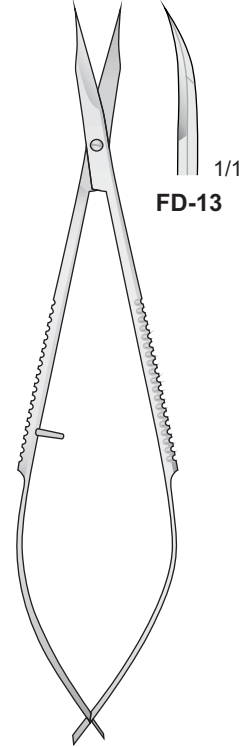

FD-13

**WESTCOTT
FD-13
120 mm**

Acuta - Sharp - Spitz
Pointu - Agudas

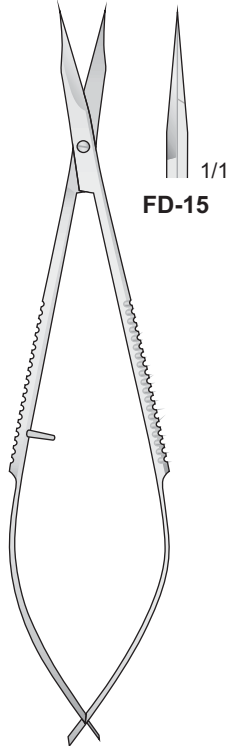

FD-15

**WESTCOTT
FD-15
120 mm**

Smussa - Blunt - Stumpf
Mousse - Romas

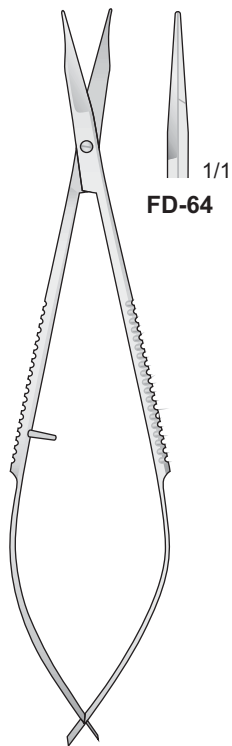

FD-64

**WESTCOTT
FD-64
120 mm**

Smussa - Blunt - Stumpf
Mousse - Romas

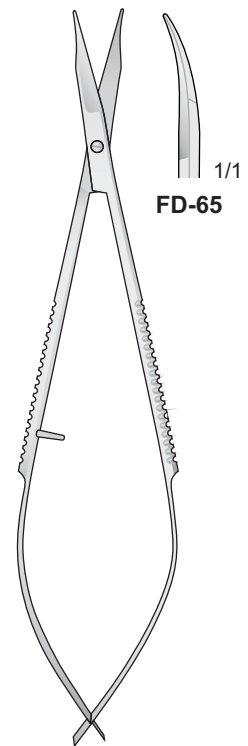

FD-65

**WESTCOTT
FD-65
120 mm**

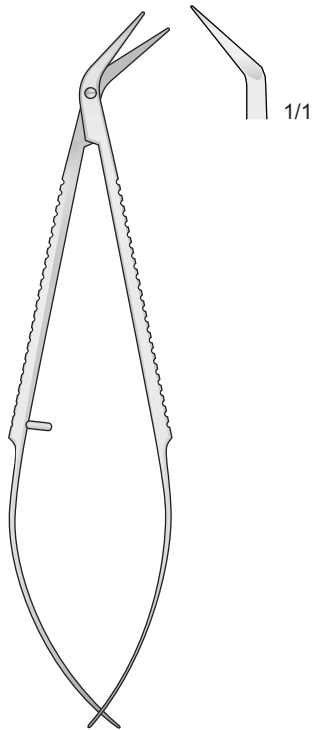

FD-03
110 mm

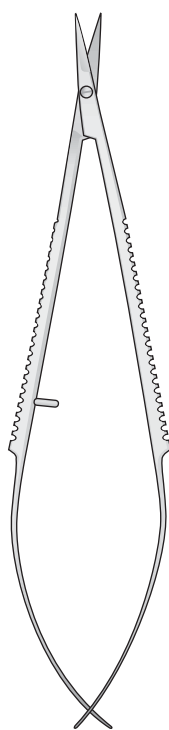

FD-04/FD-05
110 mm

Acuta - Sharp
Spitz - Pointu - Agudas



FD-04
110 mm



FD-05
110 mm

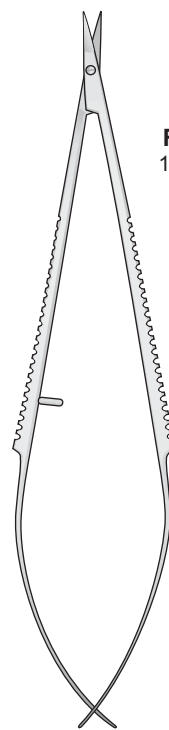

FD-55/FD-56
110 mm

Acuta - Sharp
Spitz - Pointu - Agudas



FD-55
110 mm



FD-56
110 mm

Smussa - Blunt
Stumpf - Mousse - Romas

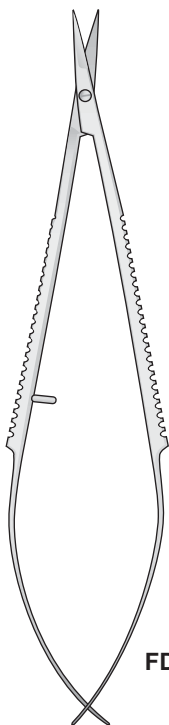

FD-49/FD-50
110 mm



FD-49
110 mm



FD-50
110 mm

Smussa - Blunt
Stumpf - Mousse - Romas

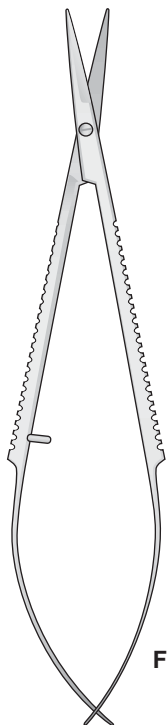

FD-41/FD-42
120 mm

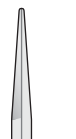

FD-41
120 mm



FD-42
120 mm

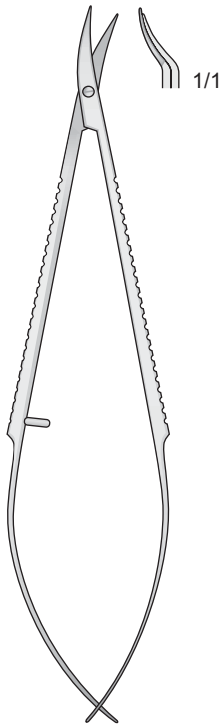

TROUTMAN
FD-69
110 mm

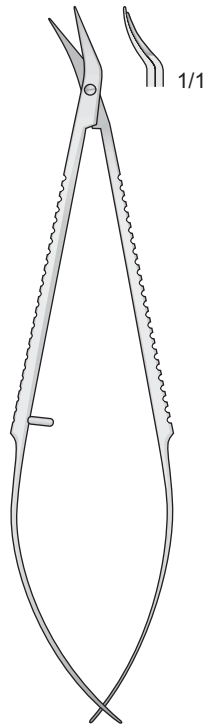

TROUTMAN
FD-70
110 mm

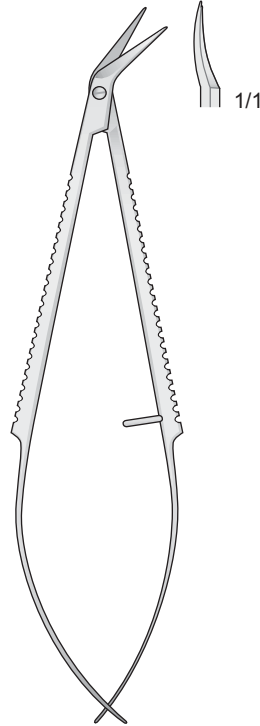

CASTROVIEJO
FD-66
110 mm

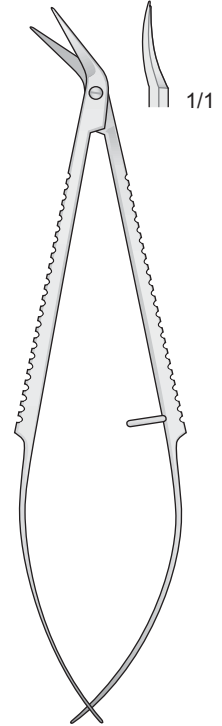

CASTROVIEJO
FD-67
110 mm

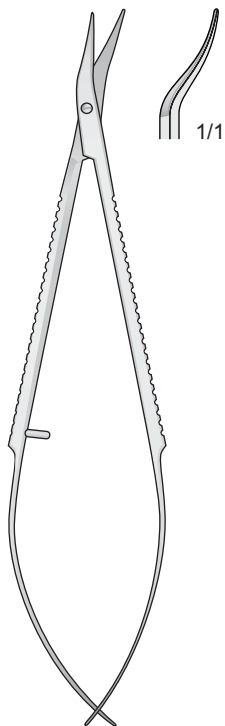

CASTROVIEJO
FD-68
110 mm

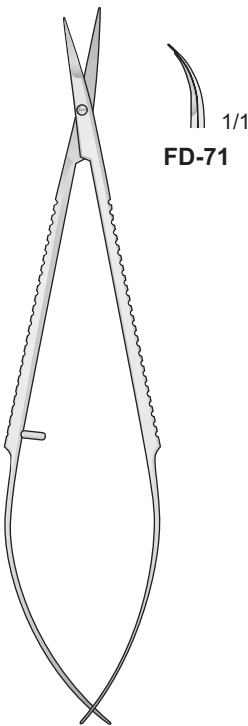

FD-71/FD-72
110 mm



FD-71

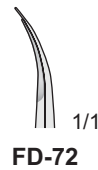

FD-72

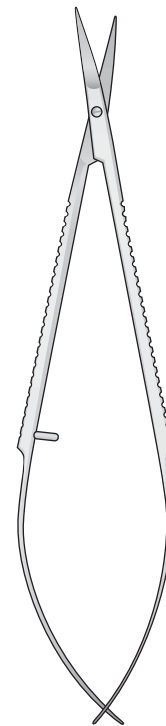

FD-73/FD-74
110 mm



FD-73

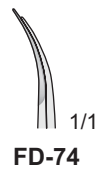

FD-74

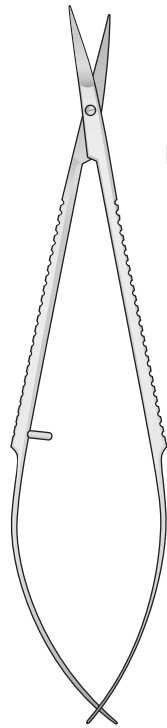

FD-146
110 mm



1/1



FD-147
115 mm

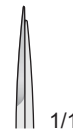

1/1

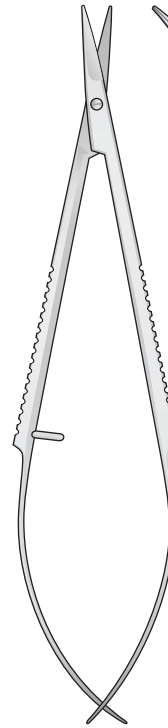

FD-62
110 mm



1/1

FD-146/FD-147

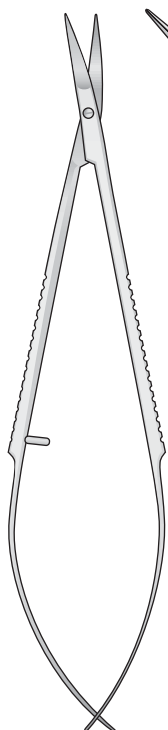

FD-11
110 mm

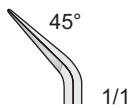

45°

1/1

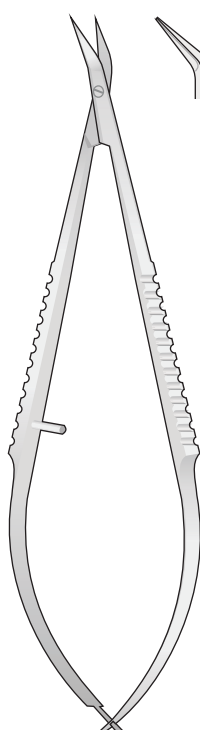

FD-235
110 mm



1/1

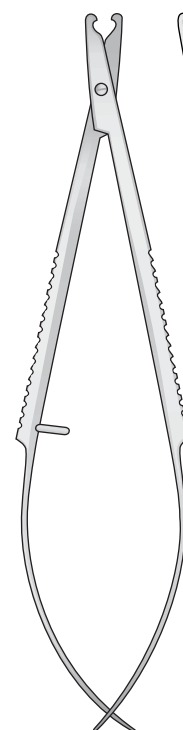

FD-61
110 mm



1/1

Acuta - Sharp - Spitz - Pointu - Agudas

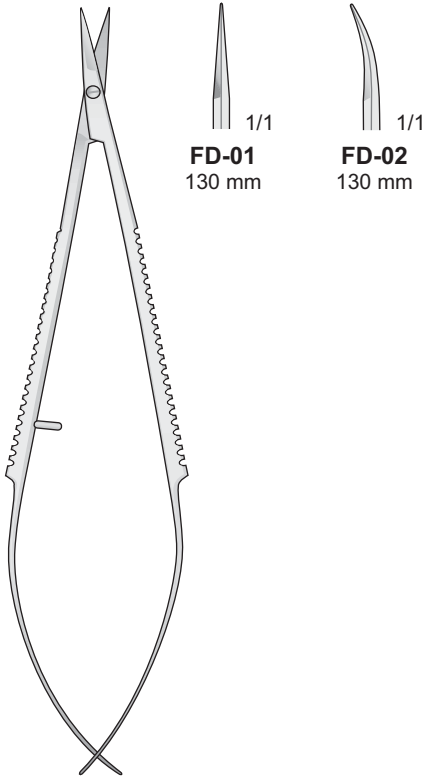

FD-01/FD-02
130 mm

Acuta - Sharp - Spitz - Pointu - Agudas

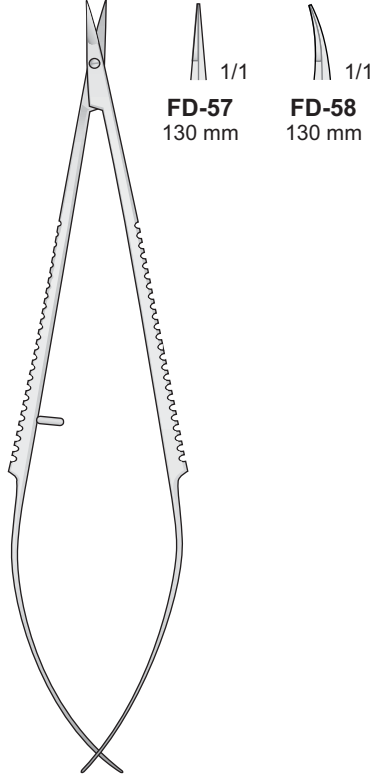

FD-57/FD-58
130 mm

Smussa - Blunt - Stumpf - Mousse - Romas

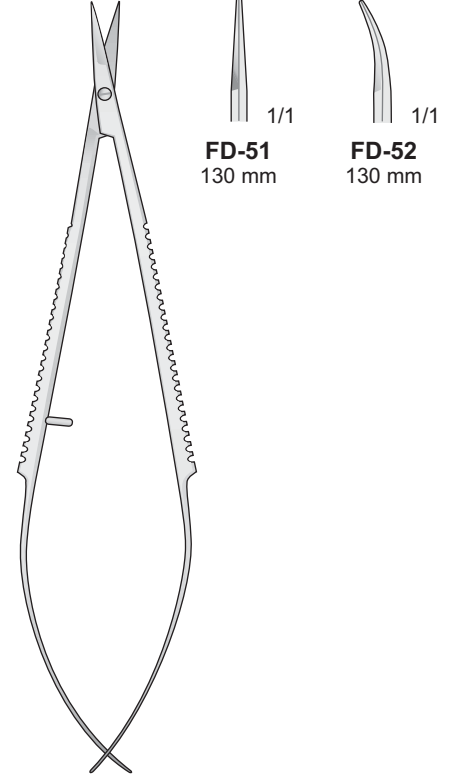

FD-51/FD-52
130 mm

Acuta - Sharp - Spitz - Pointu - Agudas

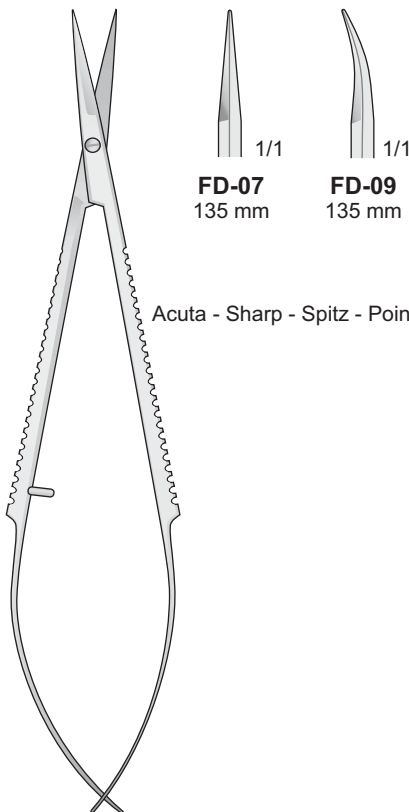

FD-07/FD-09
135 mm

Smussa - Blunt - Stumpf - Mousse - Romas

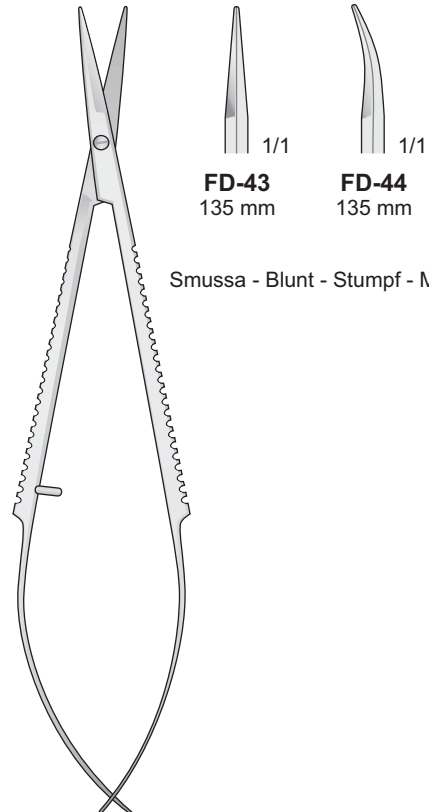

FD-43/FD-44
135 mm

Acuta - Sharp
Spitz - Pointu - Agudas



FD-59
160 mm



FD-60
160 mm



FD-137
150 mm



FD-138
150 mm

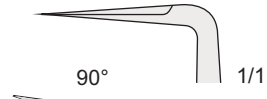

FD-40
150 mm

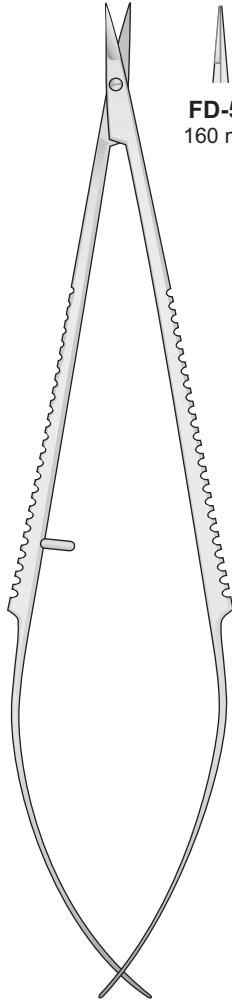

FD-137/FD-138
150 mm

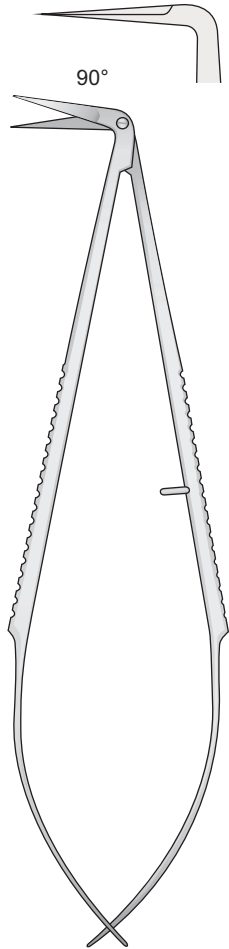
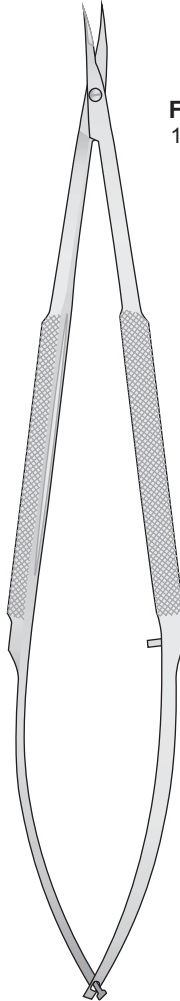

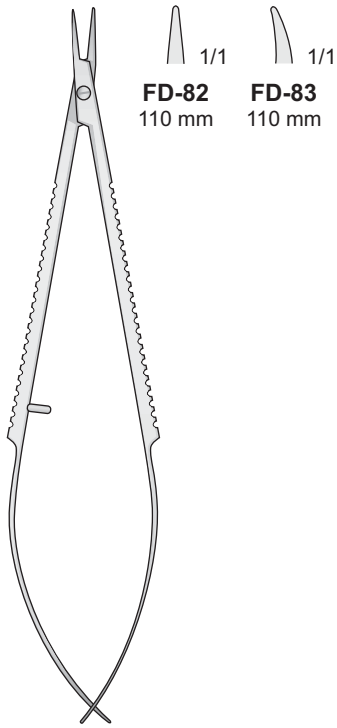

FD-82 110 mm
FD-83 110 mm

FD-82/FD-83
110 mm

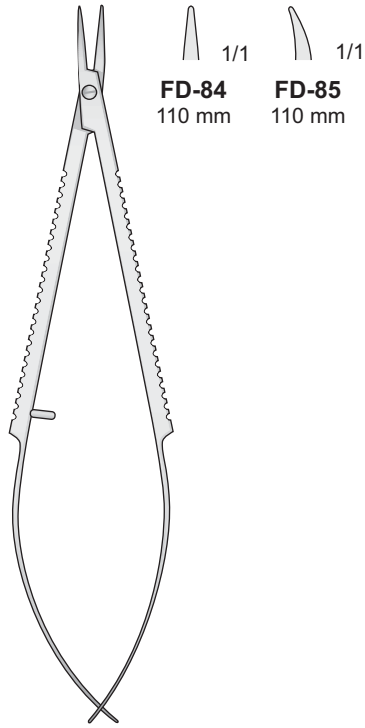

FD-84 110 mm
FD-85 110 mm

FD-84/FD-85
110 mm

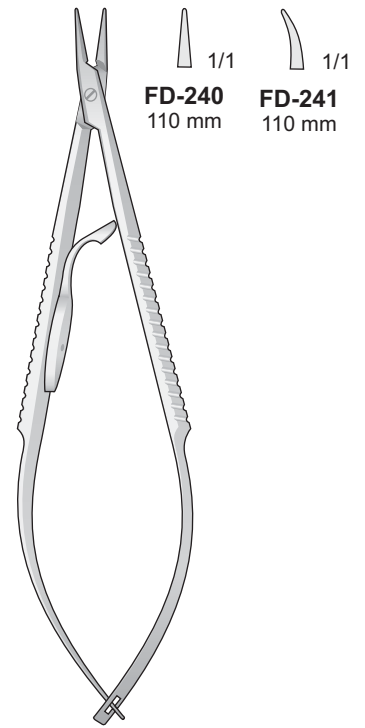

FD-240 110 mm
FD-241 110 mm

FD-240/FD-241
110 mm

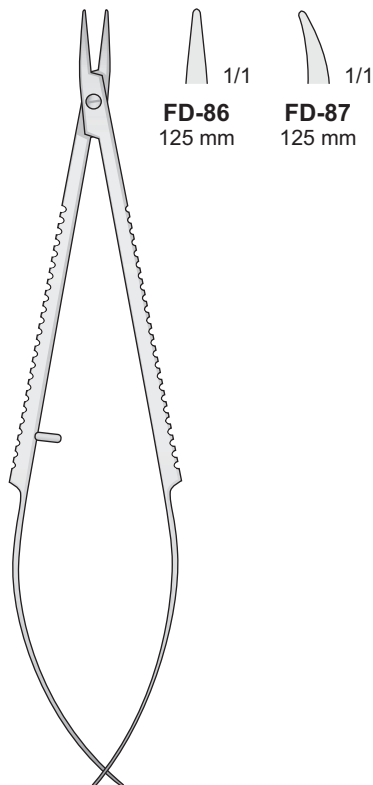

FD-86 125 mm
FD-87 125 mm

FD-86/FD-87
125 mm

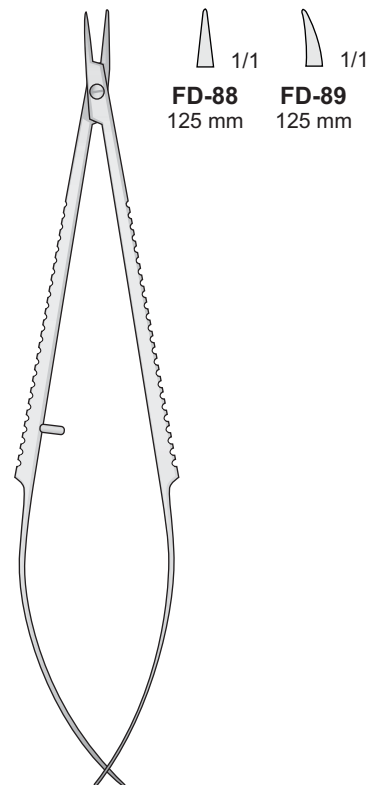

FD-88 125 mm
FD-89 125 mm

FD-88/FD-89
125 mm

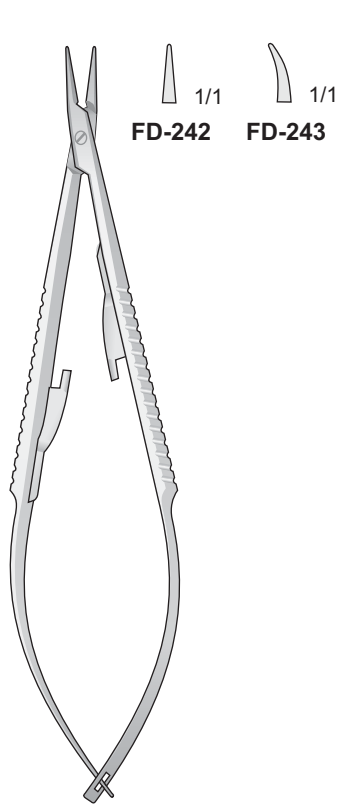

FD-242/FD-243
125 mm

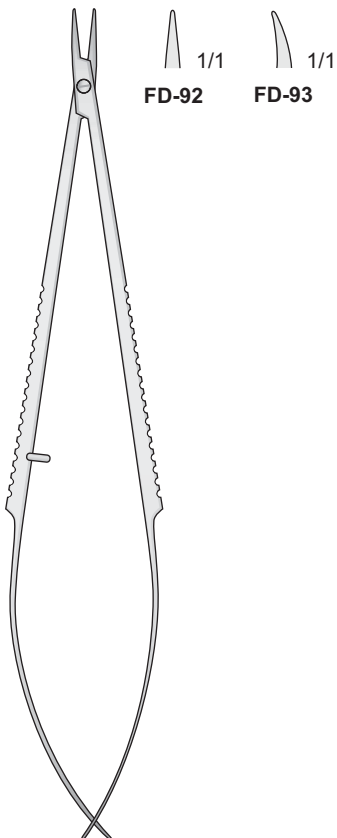

FD-92/FD-93
135 mm

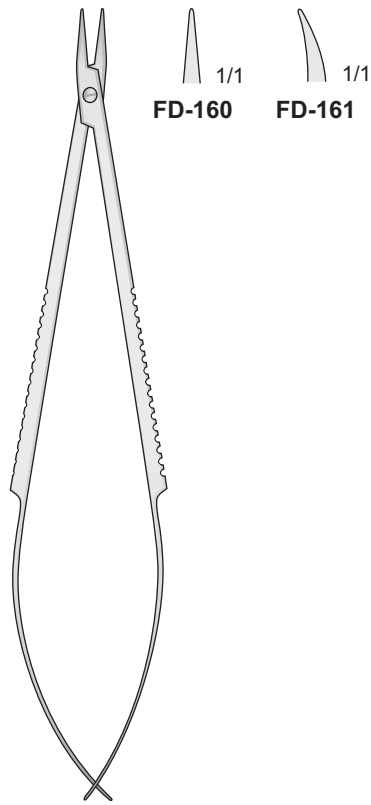

FD-160/FD-161
135 mm

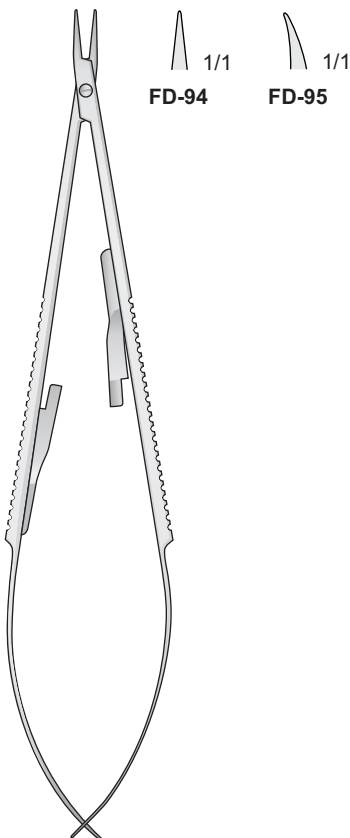

FD-94/FD-95
135 mm

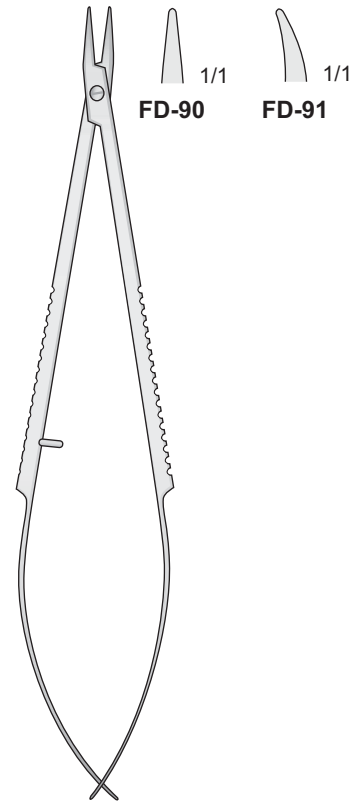

FD-90/FD-91
135 mm

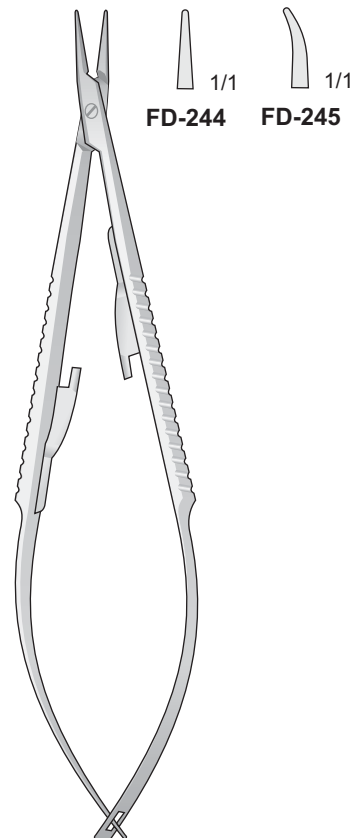

FD-244/FD-245
135 mm

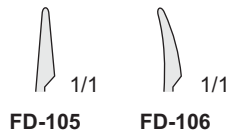
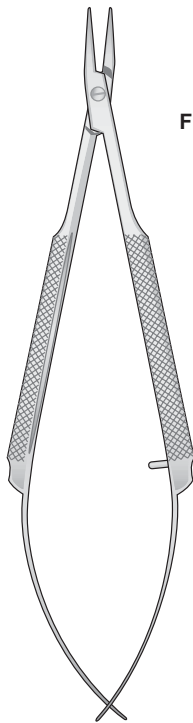

CASTROVIEJO
FD-105/FD-106
110 mm

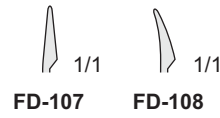
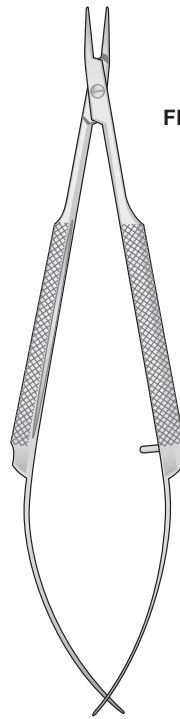

CASTROVIEJO
FD-107/FD-108
110 mm

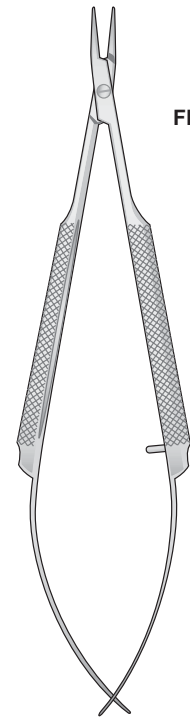

CASTROVIEJO
FD-162
110 mm

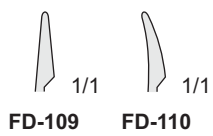
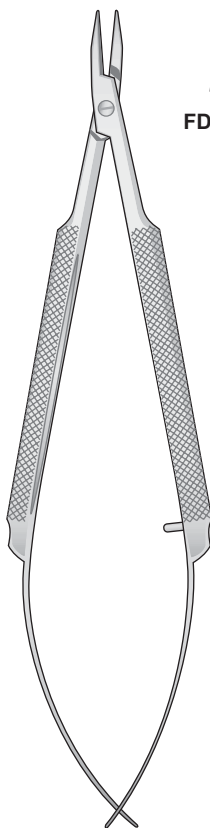

CASTROVIEJO
FD-109/FD-110
125 mm

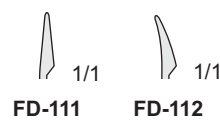
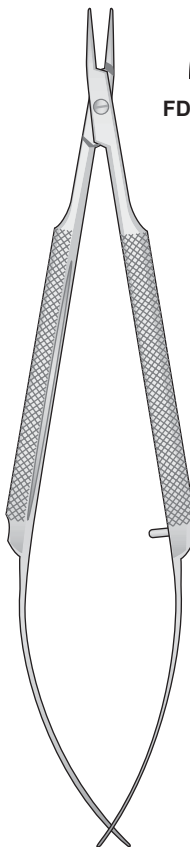

CASTROVIEJO
FD-111/FD-112
125 mm

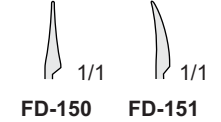
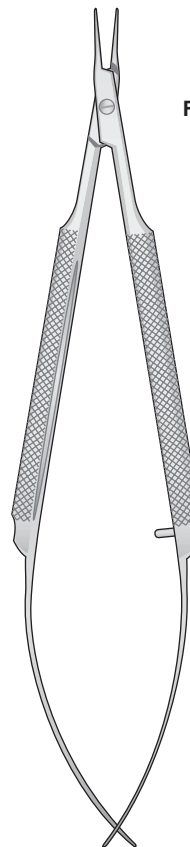

BARRAQUER
FD-150/FD-151
125 mm

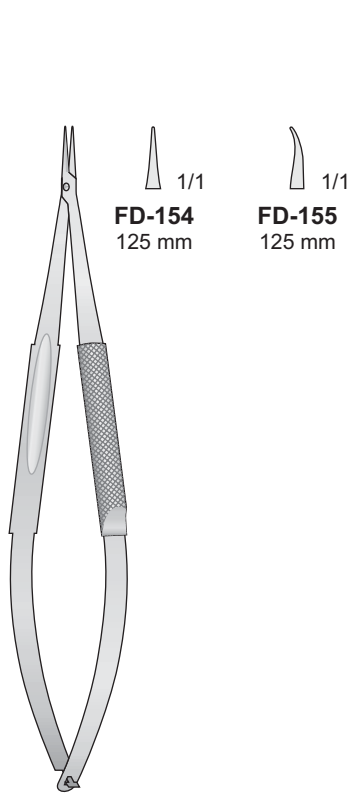

FD-154
125 mm

FD-155
125 mm

BARRAQUER
FD-154/FD-155
125 mm

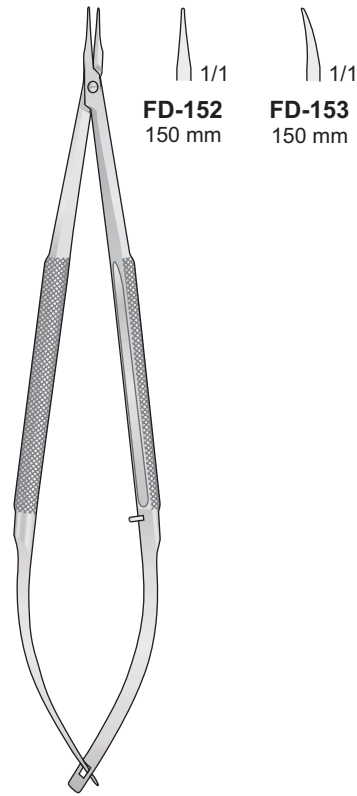

FD-152
150 mm

FD-153
150 mm

BARRAQUER
FD-152/FD-153
150 mm

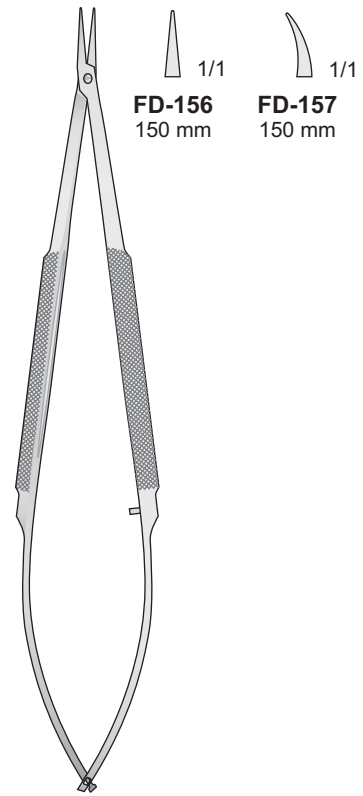

FD-156
150 mm

FD-157
150 mm

REILL
FD-156/FD-157
150 mm

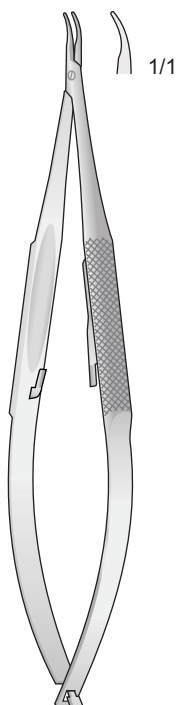

BARRAQUER
FD-215
120 mm

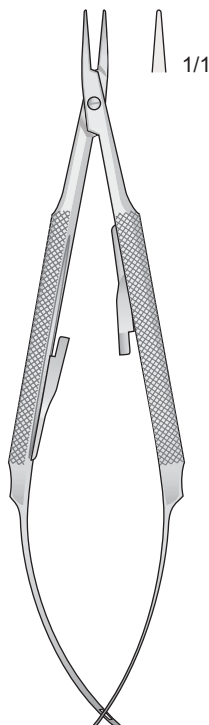

BARRAQUER
FD-214
125 mm

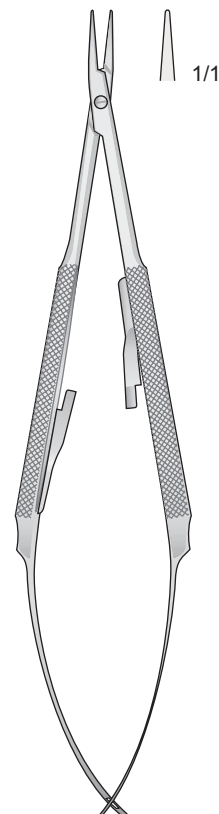

BARRAQUER
FD-216
150 mm

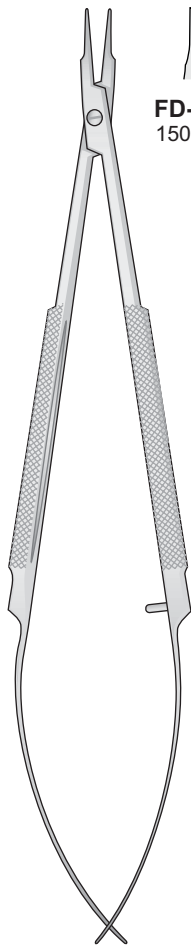

 1/1
FD-121
150 mm

 1/1
FD-122
150 mm

BARRAQUER
FD-121/FD-122
150 mm

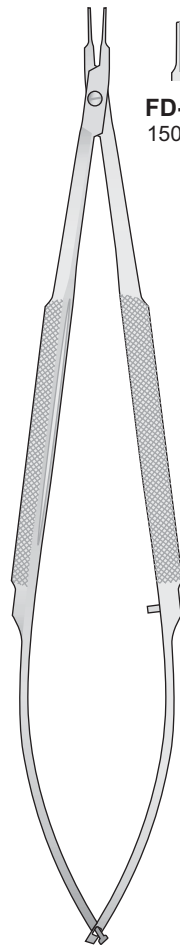

 1/1
FD-165
150 mm

 1/1
FD-166
150 mm

BARRAQUER
FD-165/FD-166
150 mm

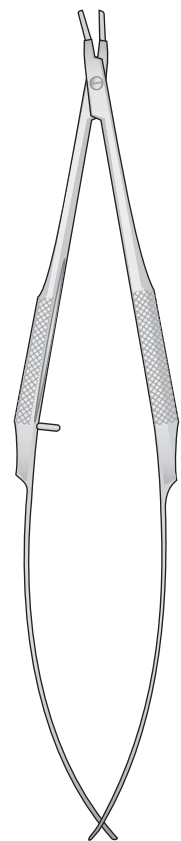

 1/1
FD-169
135 mm

BARRAQUER
FD-169
135 mm

Micro pinzette
 Micro forceps
 Mikro Pinzetten
 Micro pincers
 Pinzas finos

1 x 2 Denti
 1 x 2 Teeth
 1 x 2 Zähne
 1 x 2 Dents
 1 x 2 Dientes

1 x 2 Denti
 1 x 2 Teeth
 1 x 2 Zähne
 1 x 2 Dents
 1 x 2 Dientes

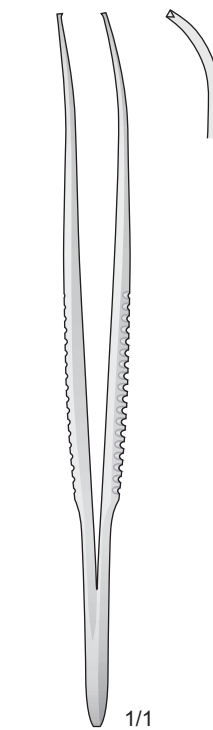
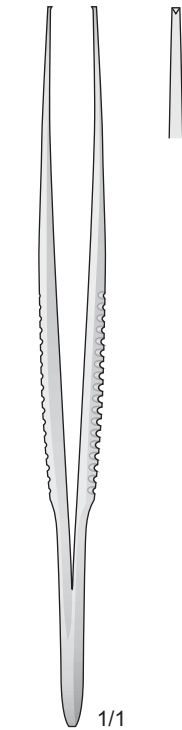
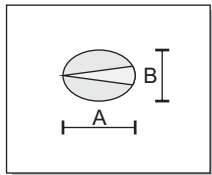

A	B		
0,4	0,25	MF-34	MF-40
0,5	0,35	MF-35	MF-41
0,7	0,55	MF-36	MF-42
1	0,8	MF-37	MF-43
1,2	0,9	MF-38	MF-44
		95 mm	95 mm

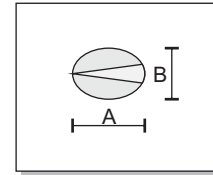

Micro pinzette
Micro forceps
Mikro Pinzetten
Micro pincers
Pinzas finos

1 x 2 Denti
1 x 2 Teeth
1 x 2 Zähne
1 x 2 Dents
1 x 2 Dientes

1 x 2 Denti
1 x 2 Teeth
1 x 2 Zähne
1 x 2 Dents
1 x 2 Dientes

Acuta
Sharp
Spitz
Pointu
Agudas

Smussa
Blunt
Stumpf
Mousse
Romas

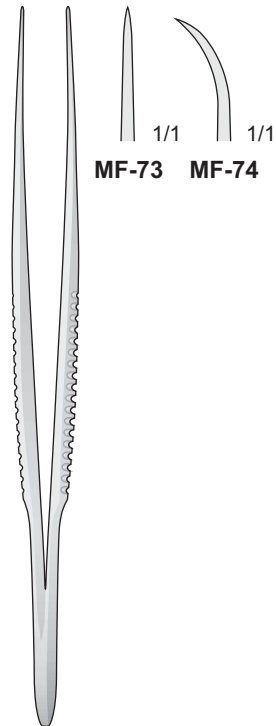

MF-73/MF-74
95 mm



MF-75/MF-76
95 mm

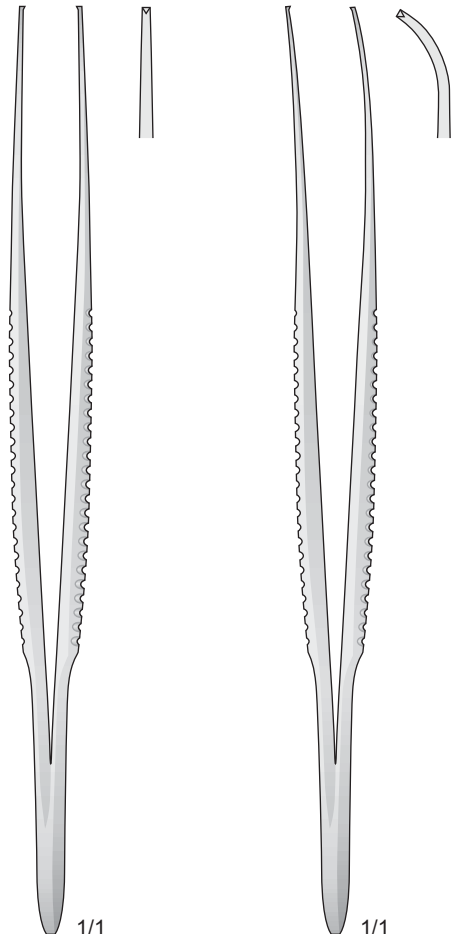

A	B		
0,4	0,25	MF-46	MF-52
0,5	0,35	MF-47	MF-53
0,7	0,55	MF-48	MF-54
1	0,8	MF-49	MF-55
1,2	0,9	MF-50	MF-56
		125 mm	125 mm

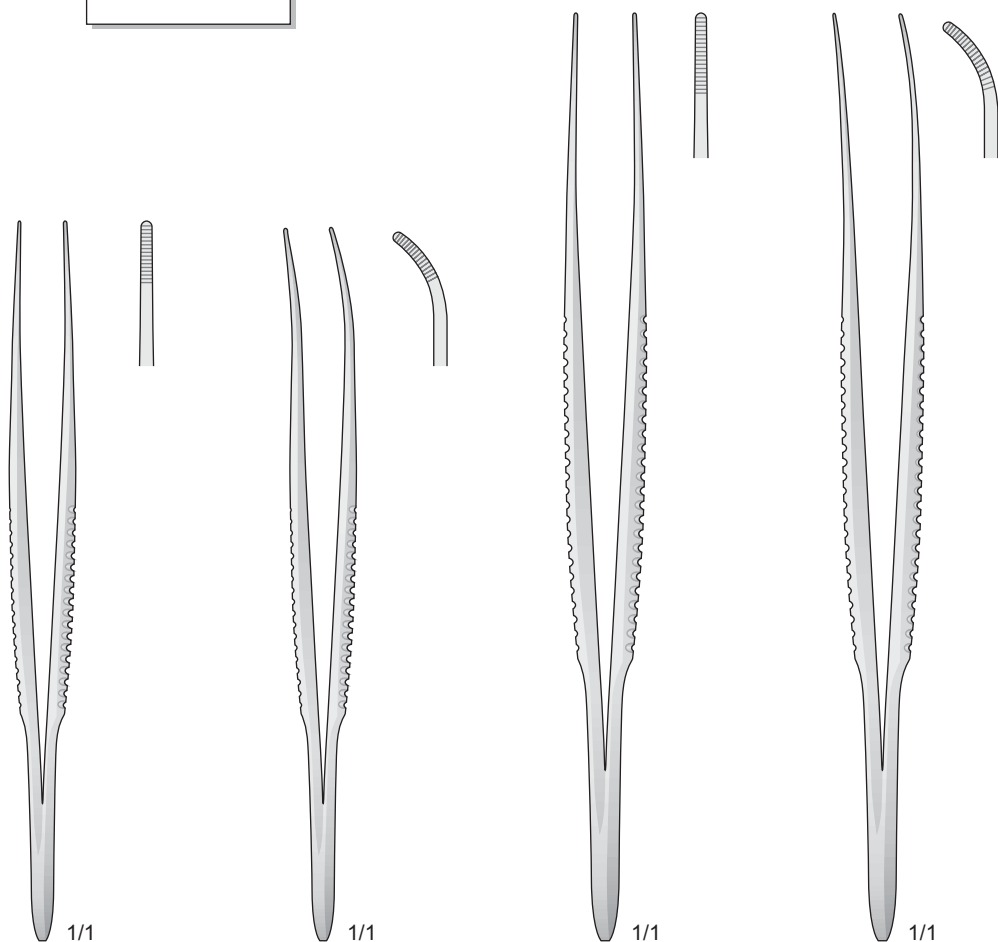
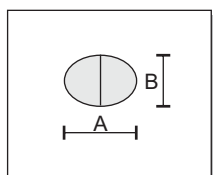

A	B				
0,5	0,4	MF-24	MF-29	MF-19	MF-13
0,6	0,5	MF-25	MF-30	MF-20	MF-14
0,9	0,7	MF-26	MF-31	MF-21	MF-15
1,3	1	MF-27	MF-32	MF-22	MF-16
1,6	1,3	MF-28	MF-33	MF-23	MF-17
		95 mm	95 mm	125 mm	125 mm

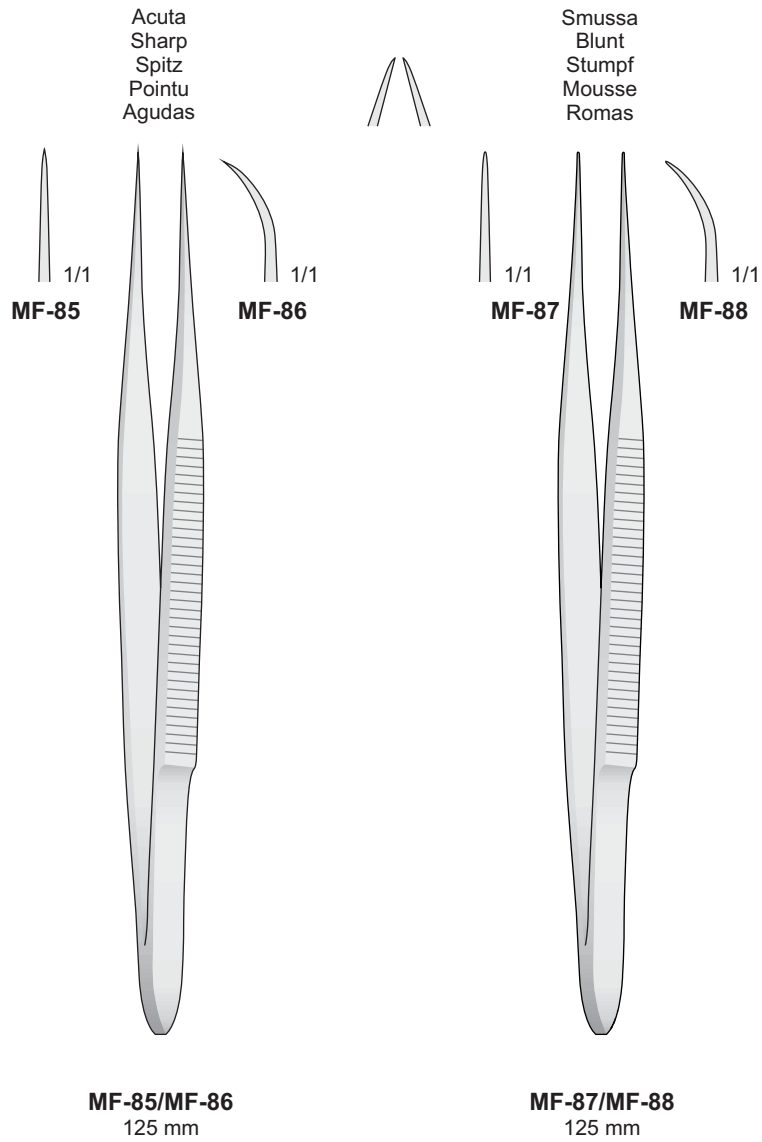

Acuta
Sharp
Spitz
Pointu
Agudas

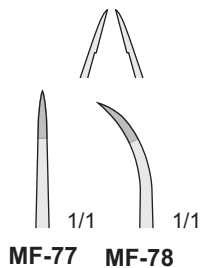
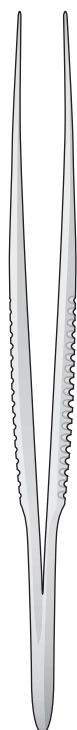

MF-77 MF-78

MF-77/MF-78
95 mm

Smussa
Blunt
Stumpf
Mousse
Romas

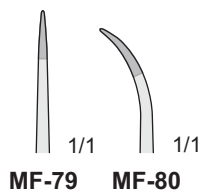
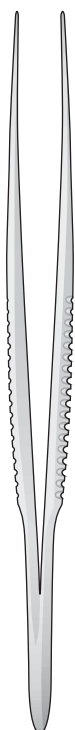

MF-79 MF-80

MF-79/MF-80
95 mm

Acuta
Sharp
Spitz
Pointu
Agudas

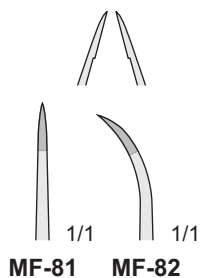
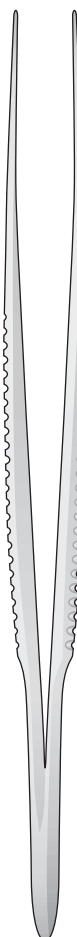

MF-81 MF-82

MF-81/MF-82
125 mm

Smussa
Blunt
Stumpf
Mousse
Romas

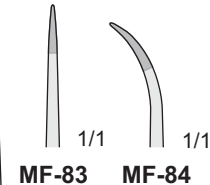
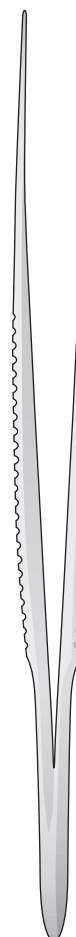

MF-83 MF-84

MF-83/MF-84
125 mm



Titan - Titanium - Titanio - Titane

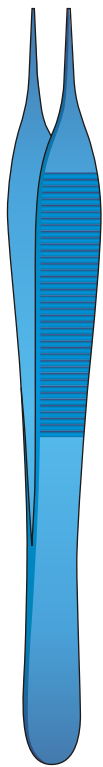

ADSON
BD-30T
120 mm

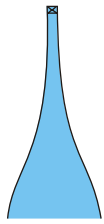

BD-30T
120 mm

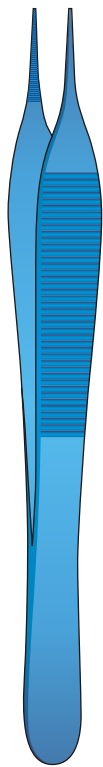

ADSON
BD-31T
120 mm

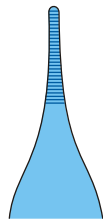

BD-31T
120 mm



BD-09T
130 mm

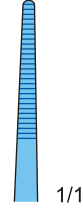

1/1



BD-42T/BD-43T
110 mm

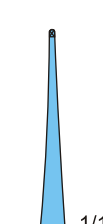

BD-42T
1/1

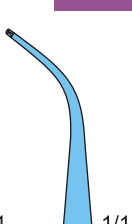

BD-43T
1/1

Iris Pinzetten - Iris Forceps - Pinze da iride - Pinza para iris - Pince à iris

Dressing Forceps
criss-cross serrated tips

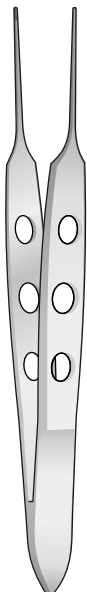
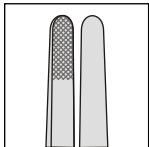

BISHOP-HARMON
MF-175
85 mm

Dressing Forceps
serrated, 0,5 mm tips

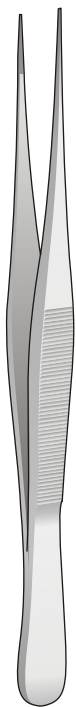

BD-32/BD-33
100 mm

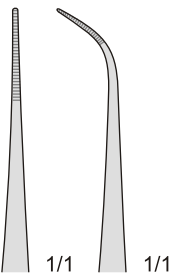

BD-32 BD-33
1/1 1/1

Dressing Forceps
serrated, 1,0 mm tips



GRAEFE
BD-04/BD-96
100 mm

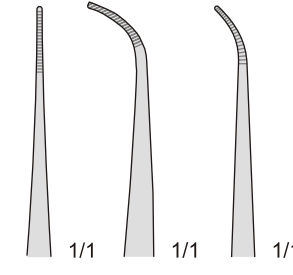

BD-04 BD-07 BD-96
1/1 1/1 1/1

Dressing & Utility Forceps
serrated, 1,5 mm tips



BD-40
110 mm

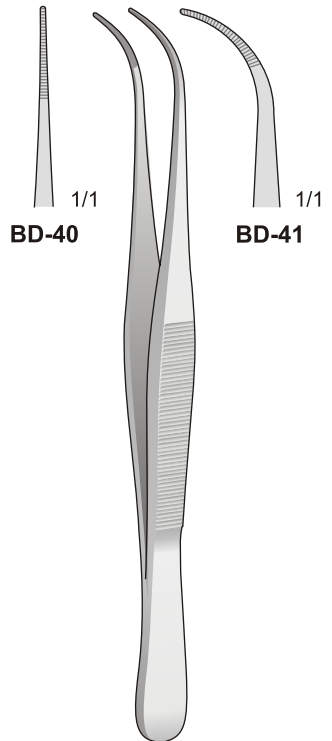

BD-41
110 mm

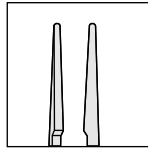
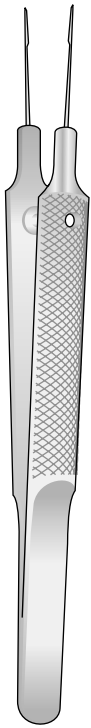

MF-150
Corneoscleral
Forceps
ultra fine 5 mm

Gerade
Straight
Diritta
Rectas
Droites

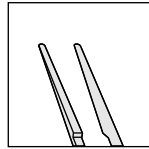

MF-151
Corneoscleral
Forceps
ultra fine 5 mm

Gebogen
Curved
Curva
Curvas
Courbes

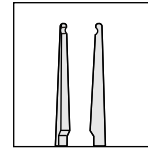

MF-152
Corneoscleral
Forceps
Pierse teeth of 0,1 mm

Gerade
Straight
Diritta
Rectas
Droites

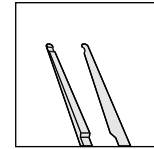

MF-153
Corneoscleral
Forceps
Pierse teeth of 0,1 mm

Gebogen
Curved
Curva
Curvas
Courbes



MF-150/MF-151
100 mm

MF-152/MF-153
100 mm

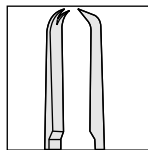
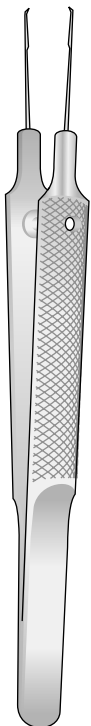

MF-154
Corneoscleral
Forceps
1x2 Teeth of 0,12 mm

Gerade, 45°
Straight, 45°
Diritta, 45°
Rectas, 45°
Droites, 45°

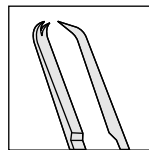

MF-155
Corneoscleral
Forceps
1x2 Teeth of 0,12 mm

Gebogen, 45°
Curved, 45°
Curva, 45°
Curvas, 45°
Courbes, 45°

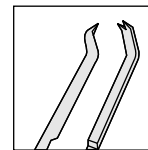

MF-156
Corneoscleral
Forceps
5 mm Long Platform
0,12 mm Teeth, 45°

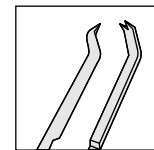

MF-157
Corneoscleral
Forceps
5 mm Long Platform
1x1 Pierse teeth, 0,1 mm



MF-154/MF-155
100 mm

MF-156/MF-157
100 mm

Nahtpinzetten mit Fadenplatte, 1x2 Zähne
 Suturing Forceps with Tying Platform, 1x2 Teeth
 Pinzette da sutura con piano prendifilo, 1x2 Denti
 Pinzas para sutura con mini placas, 1x2 Dientes
 Pincès à sutures avec plateaux pour fils, 1x2 Dents

MF-225 0,12 mm
MF-226 0,30 mm
MF-227 0,50 mm

Suturing Forceps (on wide handle)
 1x2 teeth set at 45°, with straight
 tying platform

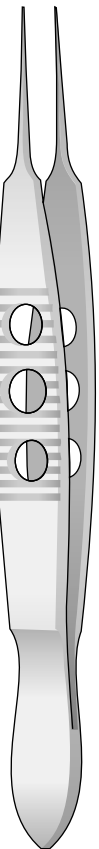
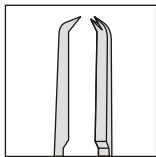

CASTROVIEJO
MF-225/MF-227
 110 mm

Suturing Forceps
 1x2 teeth of 0,12 mm set at 45°,
 with tying platform and guide pin

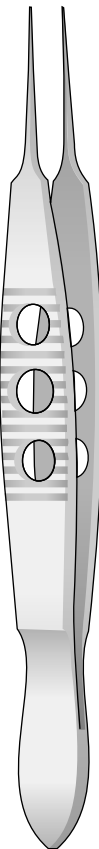
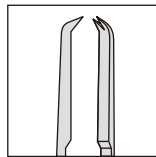

SNIDER-CASTROVIEJO
MF-228
 110 mm

Suturing Forceps
 1x2 teeth of 0,12 mm set at 90°,
 very delicate platform

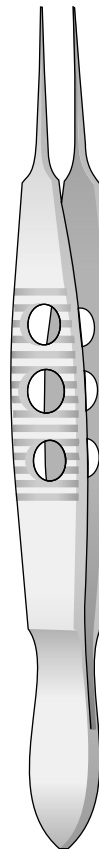
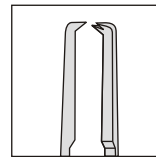

JAFFE
MF-229
 110 mm

Suturing Forceps
 1x2 teeth of 0,12 mm set at 90°,
 extra delicate platform

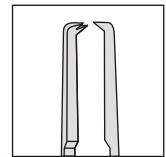

TENNANT
MF-230
 100 mm

Fadenpinzette ohne Zähne
Tying Forceps without Teeth
Pinzetta da sutura senza denti
Pinza para sutura sin dientes
Pince à sutures sans dents

Nahtpinzette mit Fadenplatte
Suturing Forceps with Tying platform
Pinza da sutura con piatto prendifilo
Pinza para sutura con mini-placas
Pince à sutures avec plateaux pour fils

extra delicate 7 mm long platform
for 8-0 to 11-0 sutures

extra delicate 6 mm long platform
for 9-0 to 11-0 sutures

Strabismuspinzette
Strabismus Forceps
Pinza da strabismo
Pinza para estrabismo
Pince à strabisme

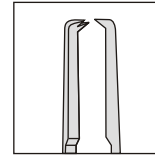
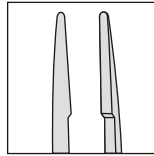

1x2 Zähne
1x2 Teeth
1x2 Denti
1x2 Dientes
1x2 Dents

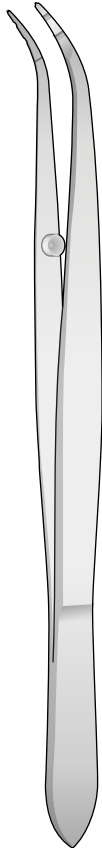

MF-100
110 mm

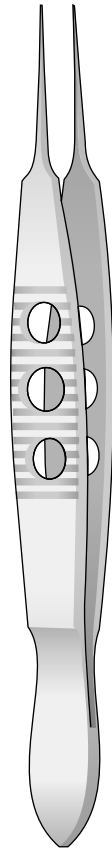

JAFFE
MF-221 Straight
MF-222 Curved
110 mm

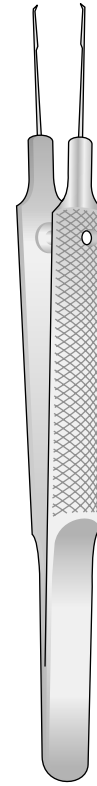

TENNANT
MF-223 Straight
MF-224 Curved
100 mm

IOL Implantationspinzette
 IOL Implantation Forceps
 Pinzette per impianti IOL
 Pinzas para implantación de lentes IOL
 Pince à implantation
 des cristallino

Pickup and
 Folding Forceps
 angled shanks,
 L-shaped jaws
 with concave
 inside surfaces

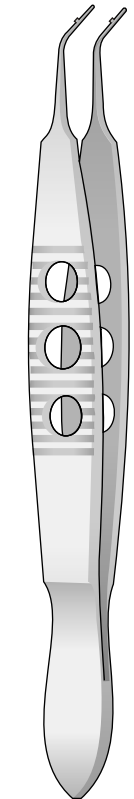
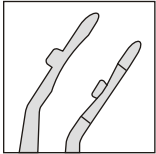

LIVERNOIS
MF-281
 105 mm

Soft IOL
 Inserter Forceps
 cross-action,
 angled shanks,
 low profile jaws
 with straight
 inside surfaces

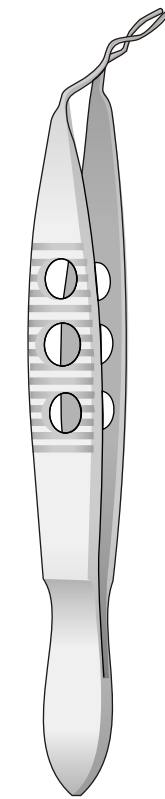
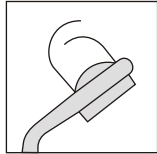

CALF II
MF-282
 105 mm

Soft IOL
 Inserter Forceps
 cross-action,
 angled shanks,
 low profile jaws
 with concave
 inside surfaces

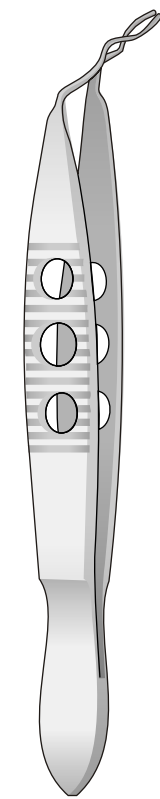
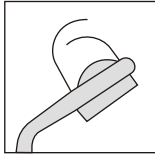

CALF III
MF-283
 105 mm

Soft IOL
 Inserter Forceps
 cross-action,
 angled shanks,
 short low profile jaws
 with concave
 inside surfaces

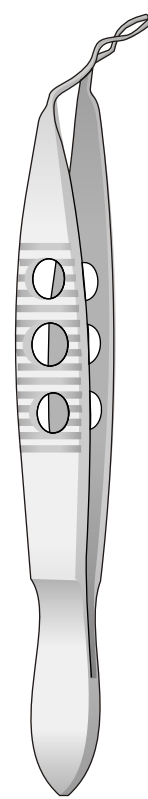
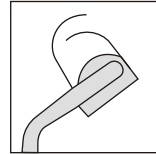

CALF IV
MF-284
 105 mm

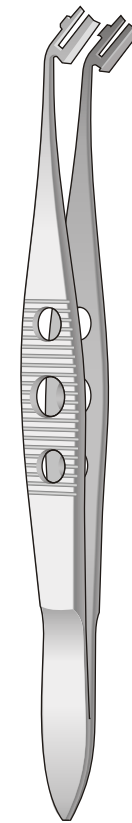
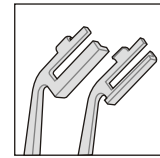

MF-293
 110 mm

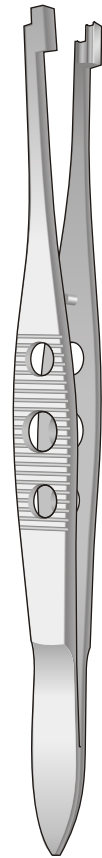
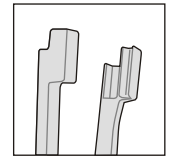

MF-295
 115 mm

6 Zähne
6 Teeth
6 Denti
6 Dents
6 Dientes

Für Erwachsene
For adults
Per adulti
Para adultos
Pour adultes

6 Zähne
6 Teeth
6 Denti
6 Dents
6 Dientes

4 Zähne
4 Teeth
4 Denti
4 Dents
4 Dientes

Für Kinder
For children
Per bambini
Para niños
Pour enfants

4 Zähne
4 Teeth
4 Denti
4 Dents
4 Dientes

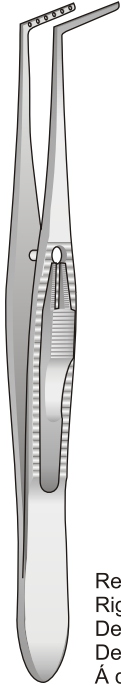

Rechts
Right
Destra
Derecha
À droite

JAMESON
MF-331
100 mm

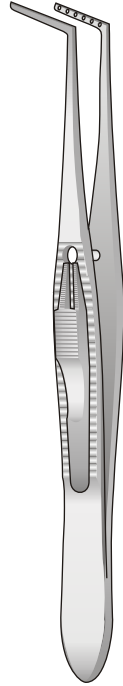

Links
Left
Sinistra
Izquierda
À gauche

JAMESON
MF-332
100 mm

Strabismuspinzette
Starbismus Forceps
Pinze da strabismo
Pinzas para estrabismo
Pinces à strabisme

Muskelpinzetten
Muscle Forceps
Pinzette muscolari
Pinzas musculares
Pinces musculaire

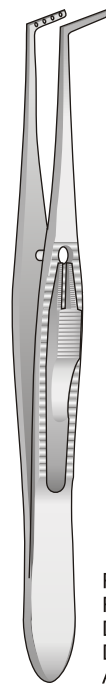

Rechts
Right
Destra
Derecha
À droite

JAMESON
MF-333
100 mm



Links
Left
Sinistra
Izquierda
À gauche

JAMESON
MF-334
100 mm

Chalazionpinzetten
Chalazion Forceps
Pinzette da calazio
Pinzas para chalación
Pinces à chalazion

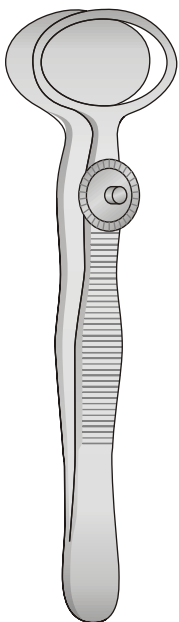

DESMARRES
BD-130/BD-132
90 mm

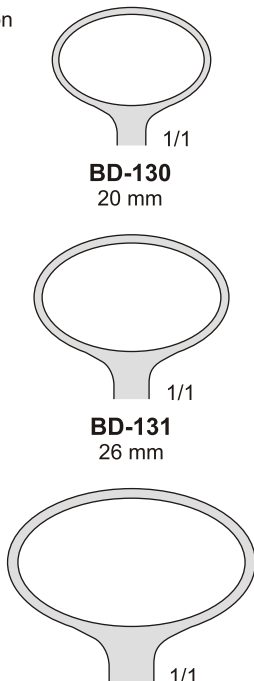

BD-130
20 mm

BD-131
26 mm

BD-132
31 mm

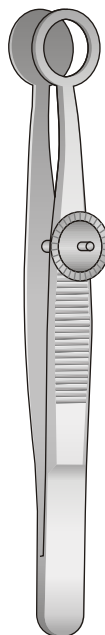
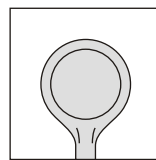

LAMBERT
BD-260
90 mm

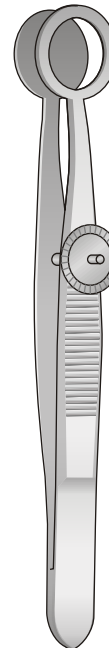
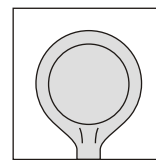

HUNT
BD-261
95 mm

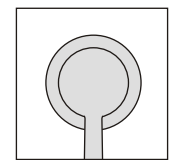

AYERS
BD-263
90 mm



16 |

Gynecology | Urology
Gynäkologie | Urologie
Gynécologie | Urologie
Ginecologia | Urología
Ginecologia | Urologia

16

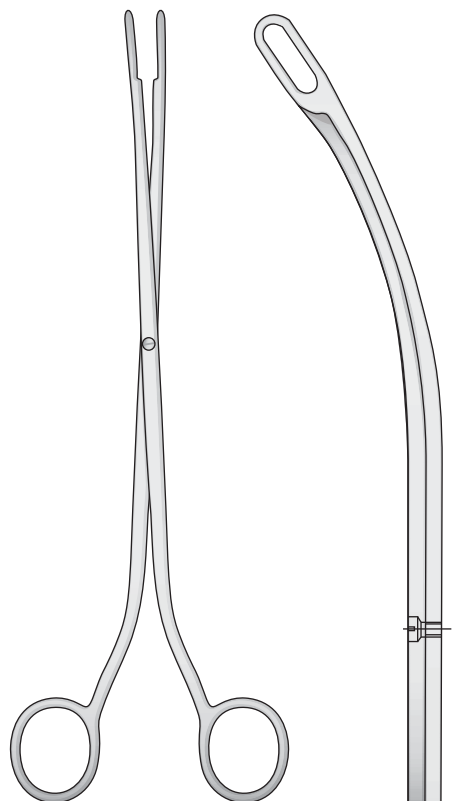

DESJARDINS
EB-11/EB-14
225 mm

Fig. 1



EB-11

Fig. 3



EB-13

Fig. 2



EB-12

Fig. 4



EB-14

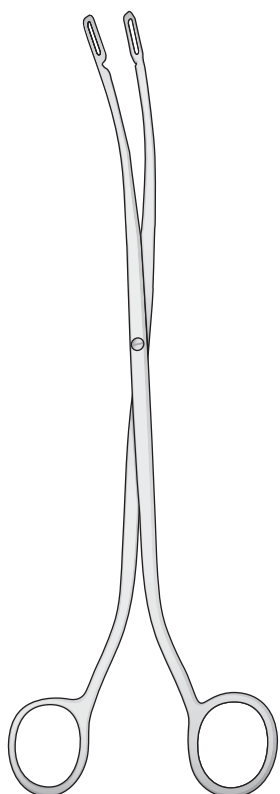

RANDALL
EB-36/EB-39
225 mm

Fig. 1

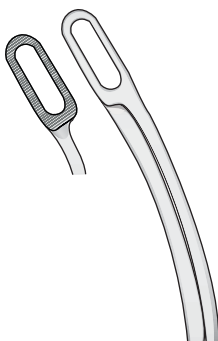

EB-36

Fig. 3



EB-38

Fig. 2



EB-37

Fig. 4



EB-39

Per uomini
For men
Für Männer
Pour hommes
Para hombres

Charr.

EA-60	8
EA-62	10
EA-63	12
EA-64	14
EA-65	16
EA-66	18
EA-67	20

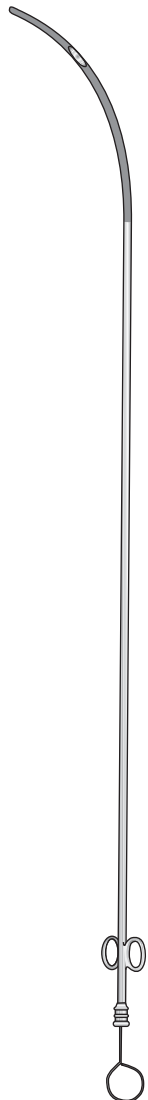

EA-60/EA-67
290 mm

Per donne
For woman
Für Frauen
Pour femmes
Para mujeres

Charr.

EA-70	6
EA-72	8
EA-74	10
EA-76	12
EA-77	14
EA-78	16
EA-79	18



EA-70/EA-79
160 mm

Ø 3 mm

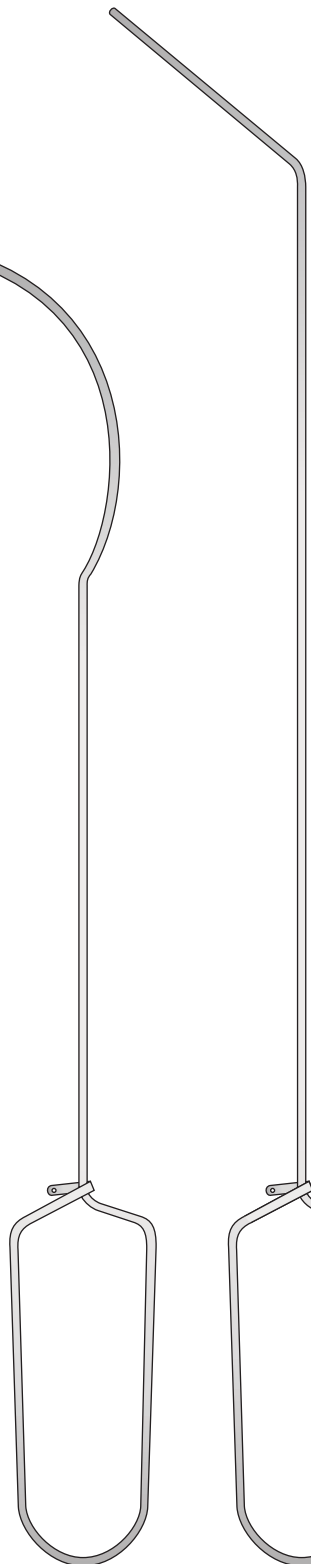

GUYON
EA-90
365 mm

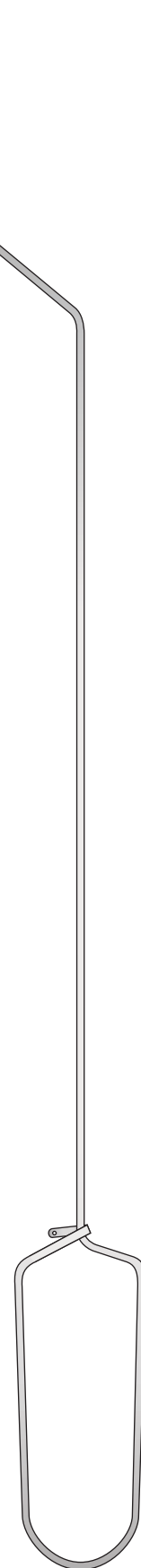

BENIQUE
EA-91
410 mm

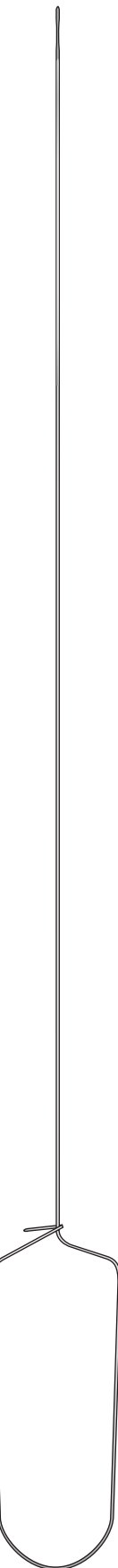

Ø 1,2 mm

EA-93
460 mm

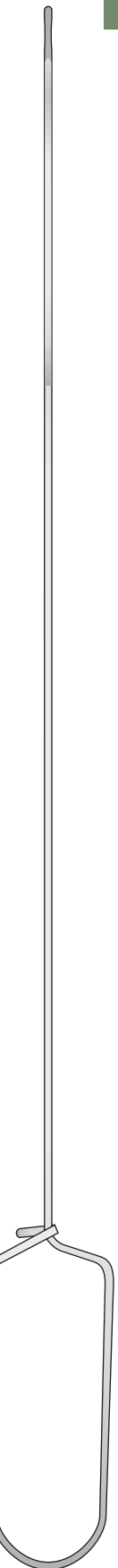

Ø 3 mm

EA-92
460 mm

FB-321 - 190 mm - Ø 3 mm
FB-322 - 190 mm - Ø 4 mm
FB-323 - 190 mm - Ø 5 mm
FB-324 - 190 mm - Ø 6 mm
FB-325 - 190 mm - Ø 7 mm
FB-326 - 190 mm - Ø 8 mm
FB-327 - 190 mm - Ø 9 mm
FB-328 - 190 mm - Ø 10 mm
FB-329 - 190 mm - Ø 11 mm

FB-331 - 300 mm - Ø 1 mm
FB-332 - 300 mm - Ø 2 mm
FB-333 - 300 mm - Ø 3 mm
FB-334 - 300 mm - Ø 4 mm
FB-335 - 300 mm - Ø 5 mm
FB-336 - 300 mm - Ø 6 mm
FB-337 - 300 mm - Ø 7 mm
FB-338 - 300 mm - Ø 8 mm
FB-339 - 300 mm - Ø 9 mm
FB-340 - 300 mm - Ø 10 mm
FB-341 - 300 mm - Ø 11 mm
FB-342 - 300 mm - Ø 12 mm
FB-343 - 300 mm - Ø 13 mm

FB-320
Set completo di 9 pezzi
con custodia

FB-330
Set completo di
13 pezzi

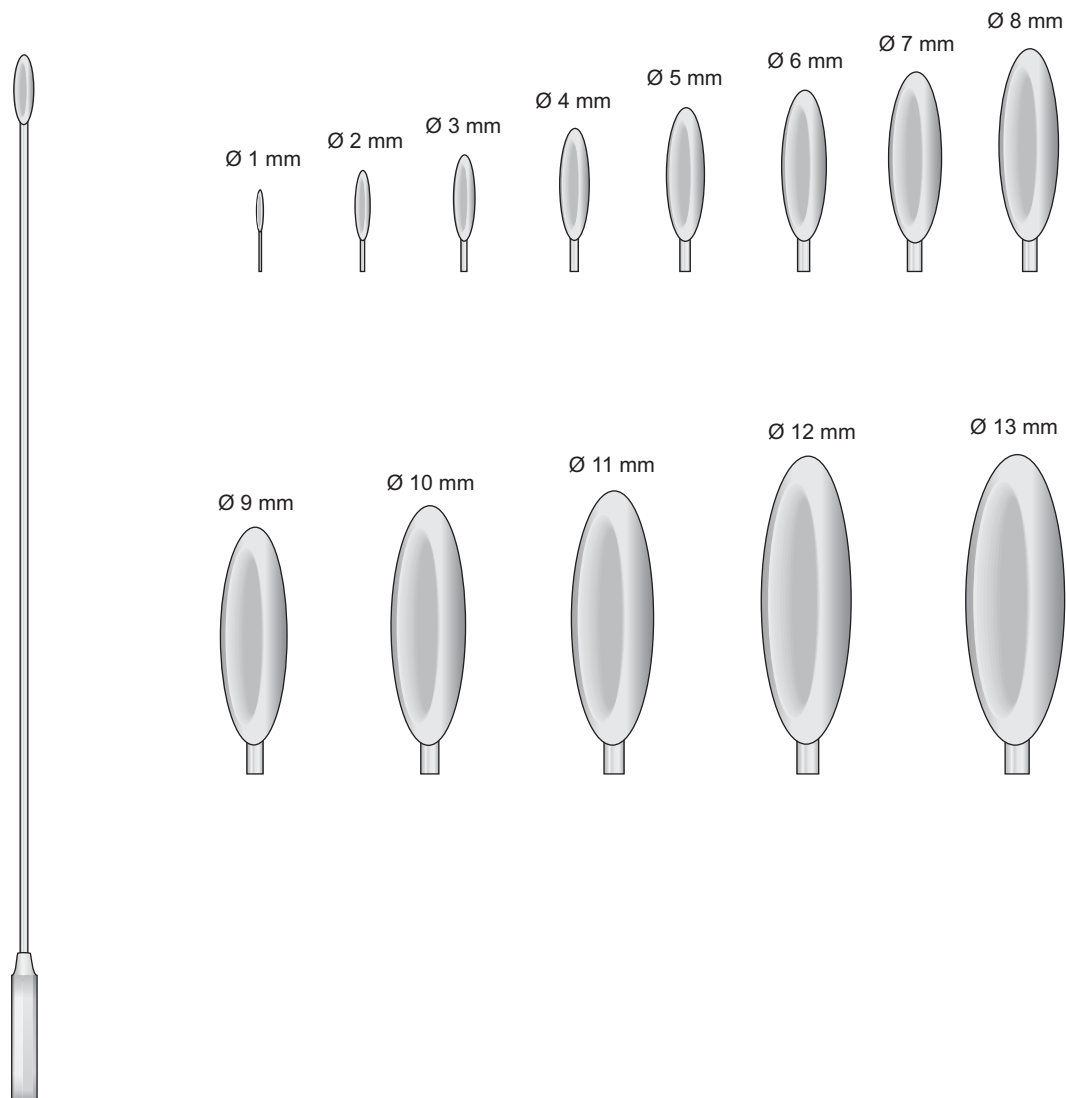

BAKES
FB-321/FB-343

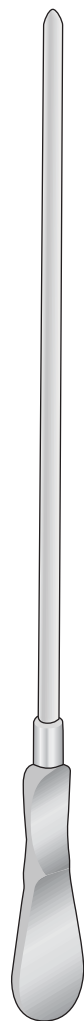

DITTEL
EB-251/EB-267
220 mm

	Charr.
EB-251	8
EB-252	9
EB-253	10
EB-254	11
EB-255	12
EB-256	14
EB-257	16
EB-258	18
EB-259	20
EB-260	22
EB-261	24
EB-262	25
EB-263	26
EB-264	27
EB-265	28
EB-266	29
EB-267	30

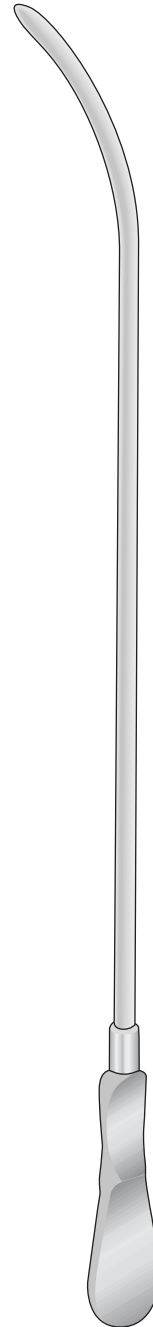

DITTEL
EB-201/EB-223
345 mm

	Charr.
EB-201	8
EB-202	9
EB-203	10
EB-204	11
EB-205	12
EB-206	13
EB-207	14
EB-208	15
EB-209	16
EB-210	17
EB-211	18
EB-212	19
EB-213	20
EB-214	21
EB-215	22
EB-216	23
EB-217	24
EB-218	25
EB-219	26
EB-220	27
EB-221	28
EB-222	29
EB-223	30

EB-49 - Ø 10 mm  1/1

EB-48 - Ø 9 mm  1/1

EB-47 - Ø 8 mm  1/1

EB-46 - Ø 7 mm  1/1

EB-45 - Ø 6 mm  1/1

EB-44 - Ø 5 mm  1/1

EB-43 - Ø 4 mm  1/1

EB-42 - Ø 3 mm  1/1

EB-42/EB-49
190 mm

Sonde per dotto biliare, Elastiche
Gall Stone Probes, Elastic
Gallensteinsonden, Federnd
Explorateurs pour calculs biliaires, Élastiques
Exploradores para cálculos biliares, Elásticos

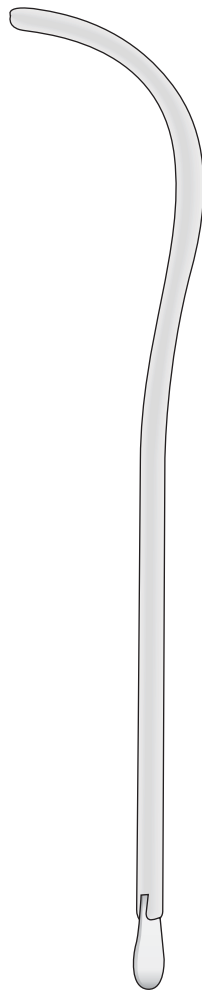

GUYON
EB-231/EB-249
255 mm

	Ben.	Charr.
EB-231	24	12
EB-232	26	13
EB-233	28	14
EB-234	30	15
EB-235	32	16
EB-236	34	17
EB-237	36	18
EB-238	38	19
EB-239	40	20
EB-240	42	21
EB-241	44	22
EB-242	46	23
EB-243	48	24
EB-244	50	25
EB-245	52	26
EB-246	54	27
EB-247	56	28
EB-248	58	29
EB-249	60	30



DESJARDINS
EB-18/EB-20
280 mm

Ø 4,3 mm

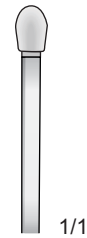

1/1

EB-18

Ø 6,0 mm



1/1

EB-19

Ø 7,0 mm

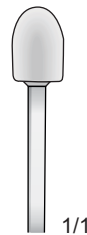

1/1

EB-20

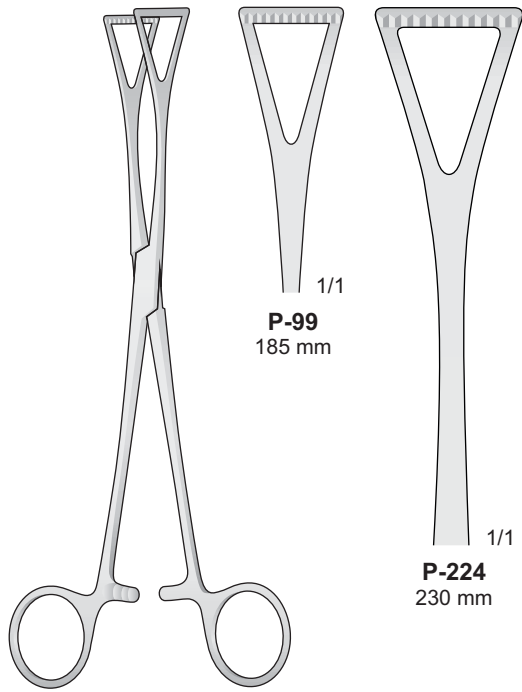

DUVAL
P-99/P-224

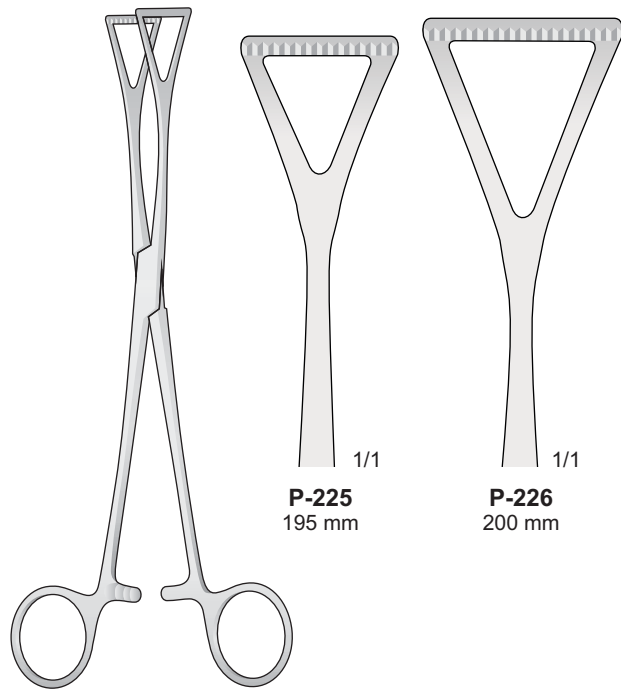

DUVAL-COLLIN
P-225/P-226

Pinze per peduncoli renali - Kidney pedicle clamp forceps - Nierenstielklemmen
Pinces-clamps pour pédicules rénaux - Pinzas-clamps para pedúncolos renales

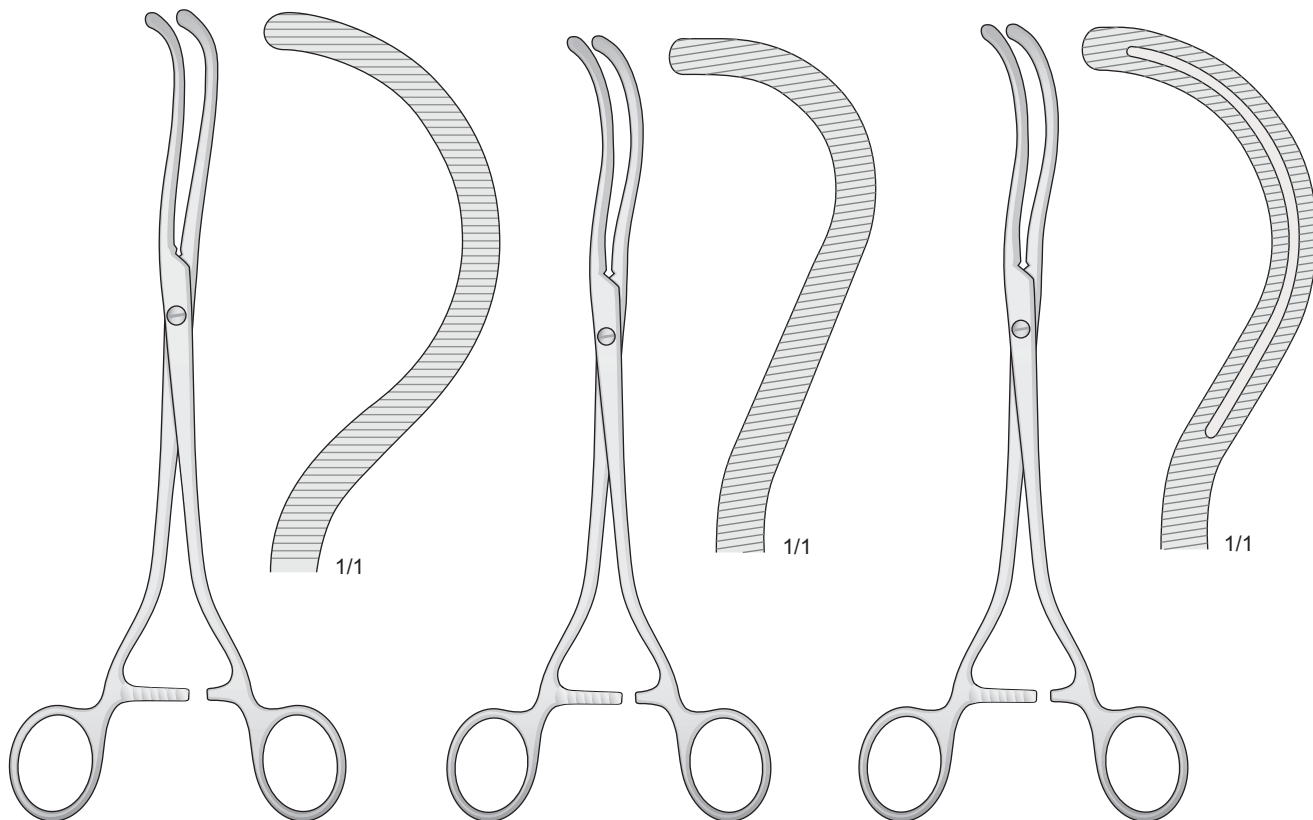

BRAUN
EB-30
245 mm

GUYON
EB-31
235 mm

STILLE
EB-32
240 mm

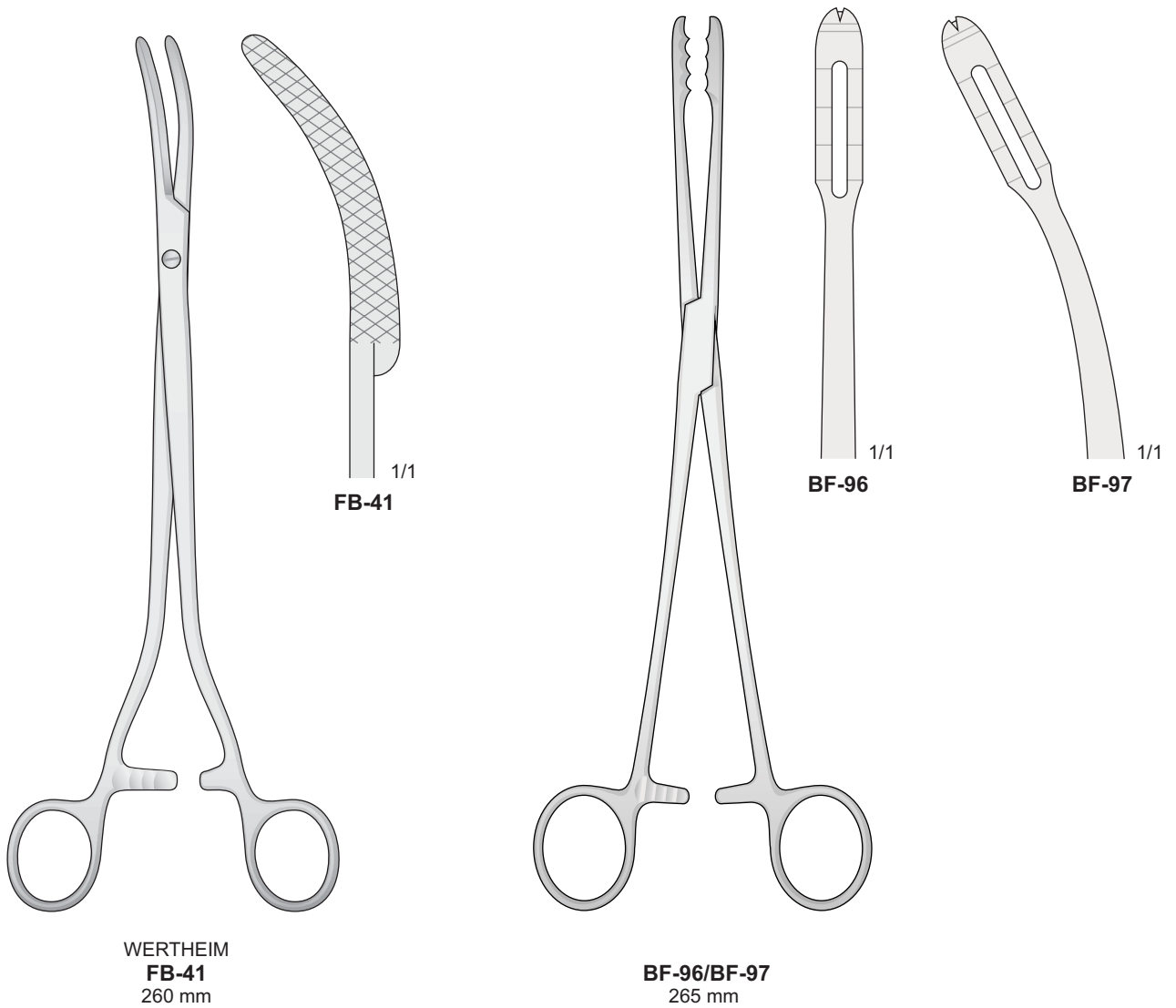

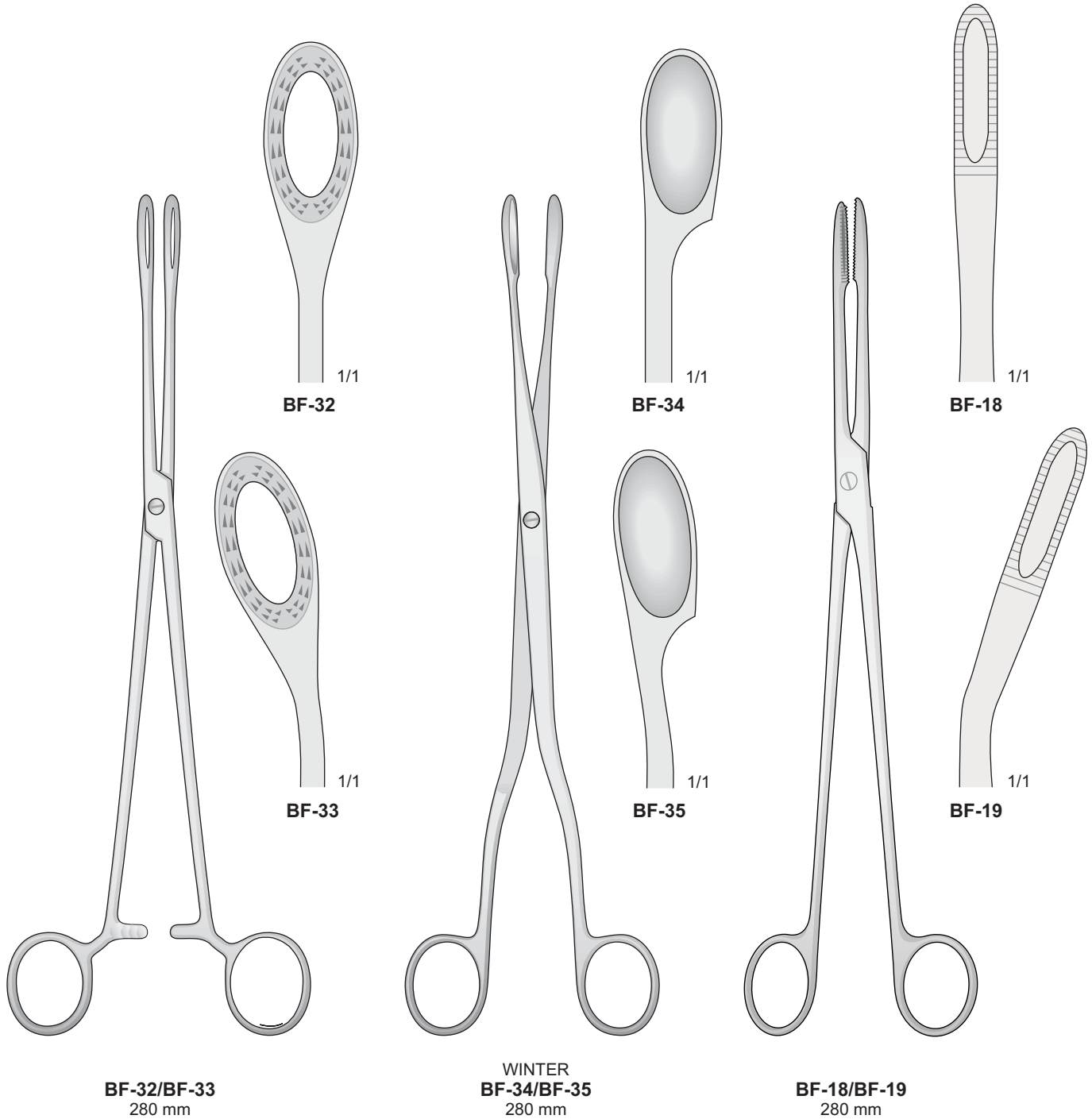

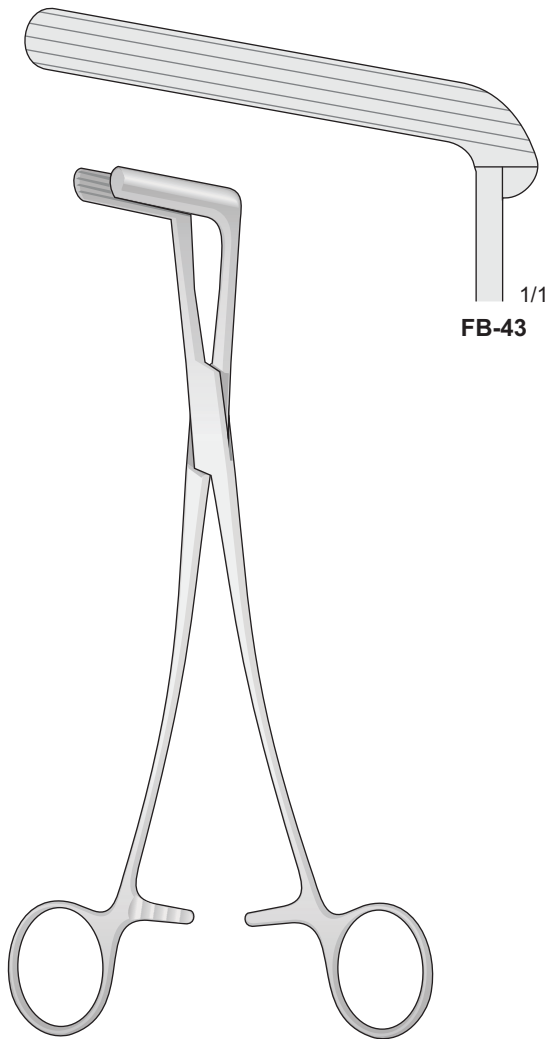

WERTHEIM
FB-43
235 mm

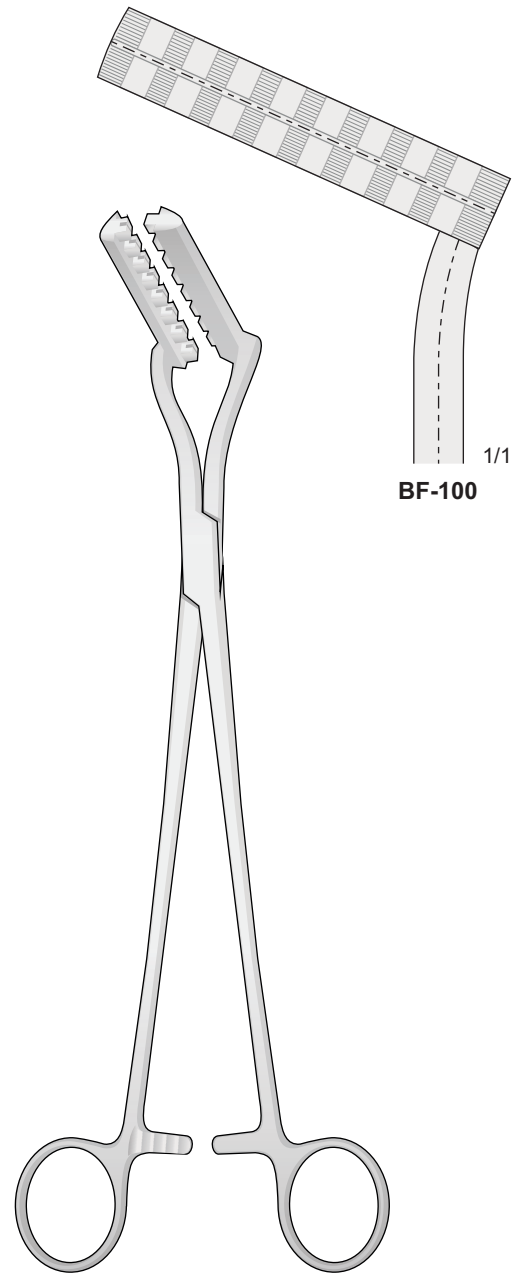

BF-100
280 mm

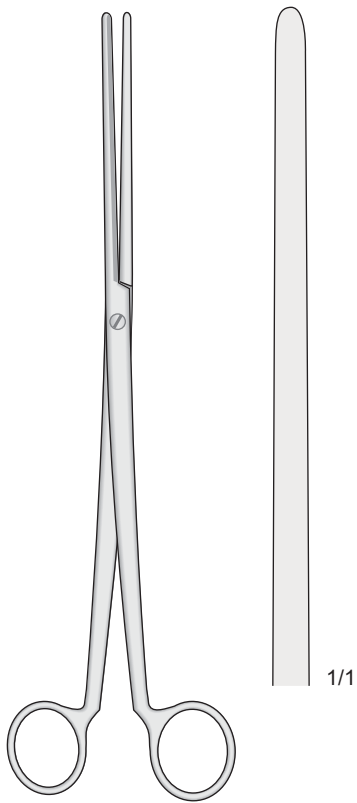

COLLIN
BF-03
260 mm

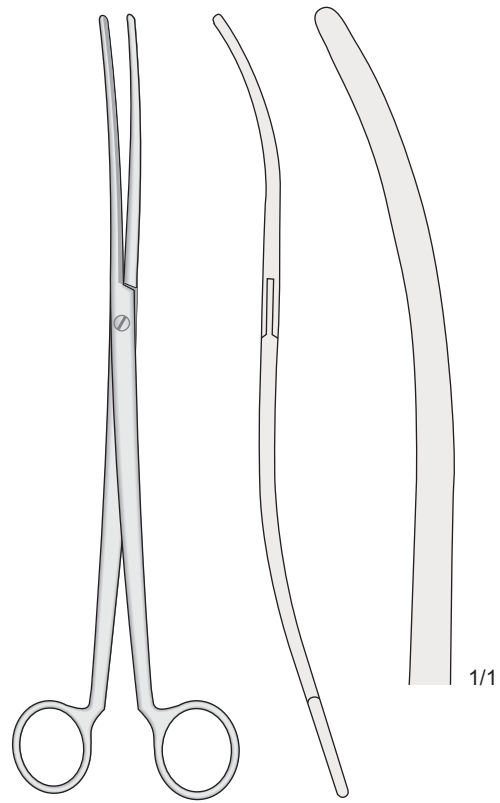

COLLIN
BF-04
260 mm

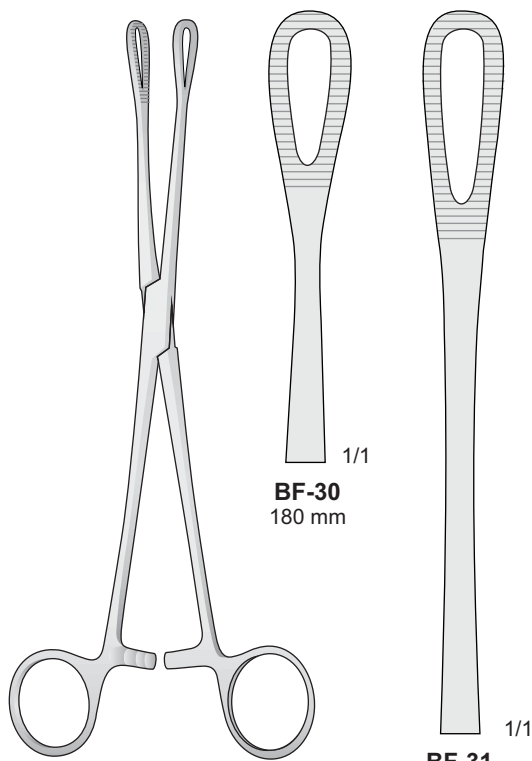

RAMPLEY
BF-30/BF-31

BF-30
180 mm

BF-31
245 mm

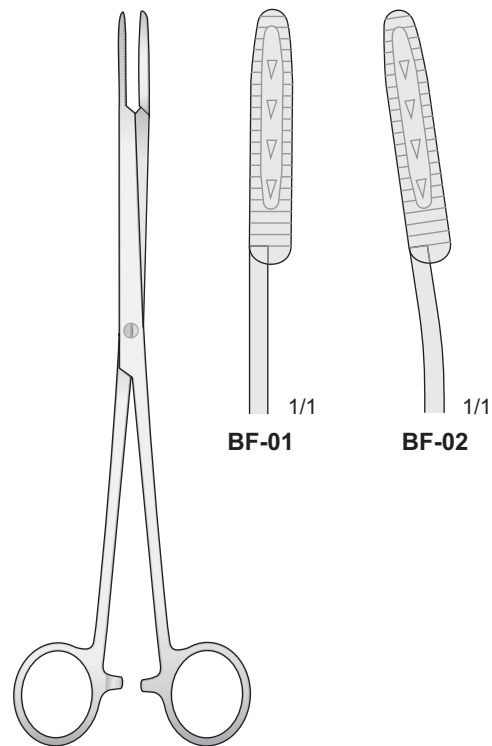

MAIER
BF-01/BF-02
245 mm

BF-01

BF-02

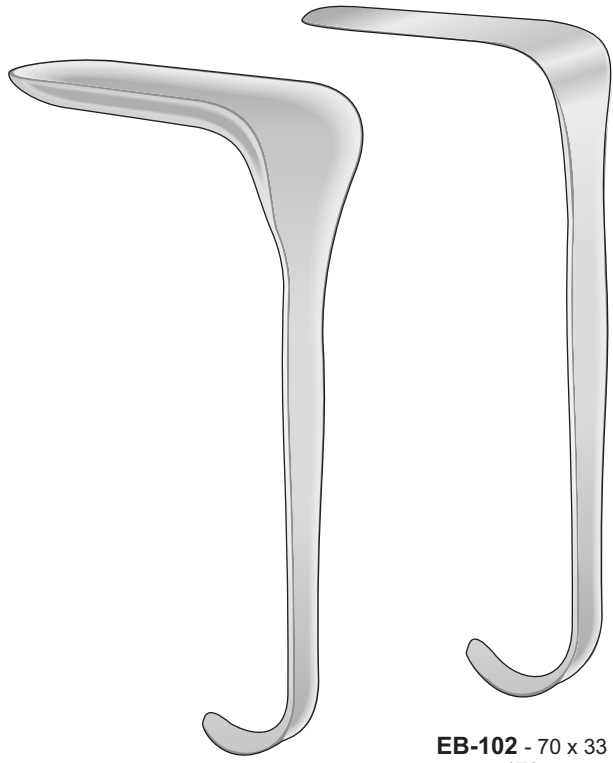

KALLMORGEN
EB-101 - 70 x 40 mm
170 mm

EB-102 - 70 x 33 mm
170 mm

EB-100
Set 2 pezzi - Set 2 pieces
Set 2 stück - Set 2 pièces
Set 2 piezas
70 x 40 mm
70 x 33 mm

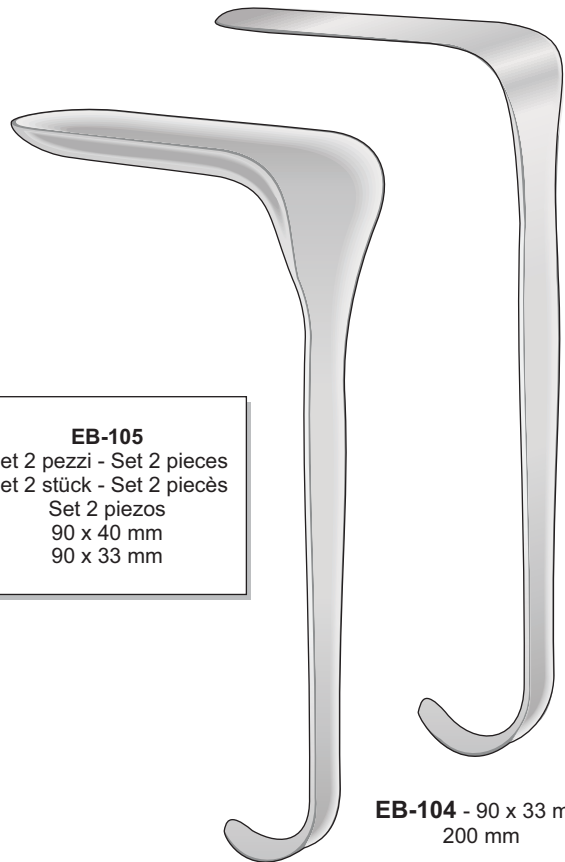

KALLMORGEN
EB-103 - 90 x 40 mm
200 mm

EB-104 - 90 x 33 mm
200 mm

EB-105
Set 2 pezzi - Set 2 pieces
Set 2 stück - Set 2 pièces
Set 2 piezas
90 x 40 mm
90 x 33 mm

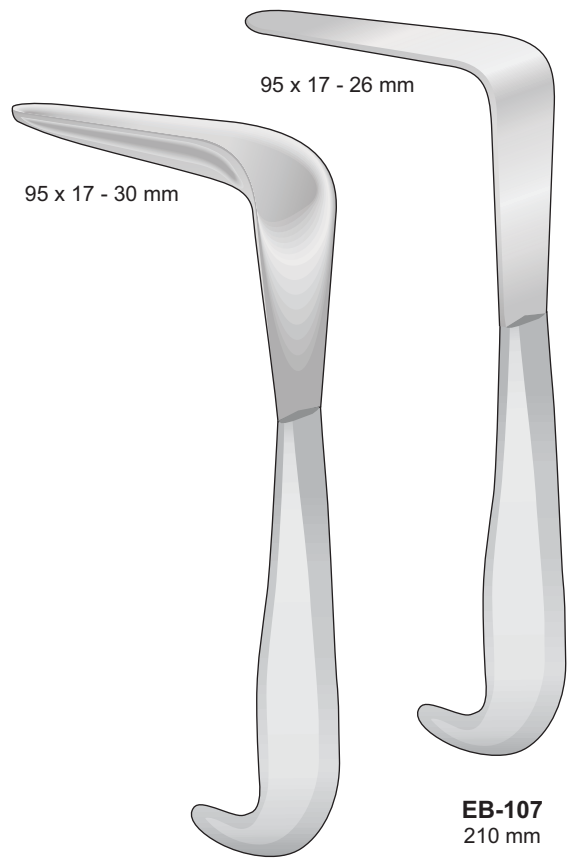

MATHIEU
EB-106
210 mm

EB-107
210 mm

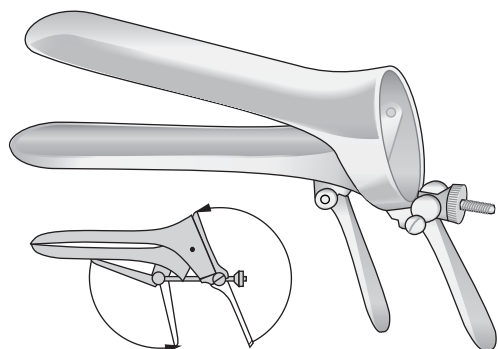

CUSCO
ER-49 Fig. 0 77x17 mm
ER-48 Fig. 1 75x33 mm
ER-47 Fig. 2 86x36 mm
ER-46 Fig. 3 97x36 mm

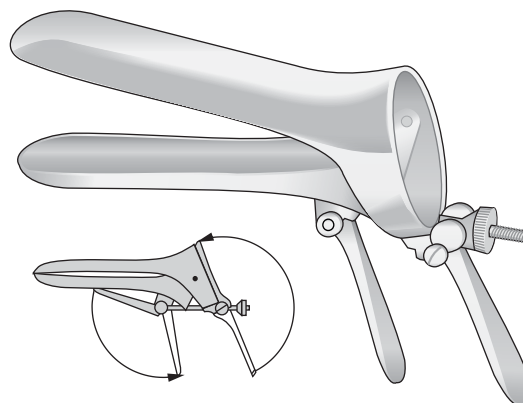

CUSCO
 SCHWEIZER MODELL
ER-61 Fig.1 90x23 mm
ER-62 Fig.2 100x24 mm
ER-63 Fig.3 105x27 mm

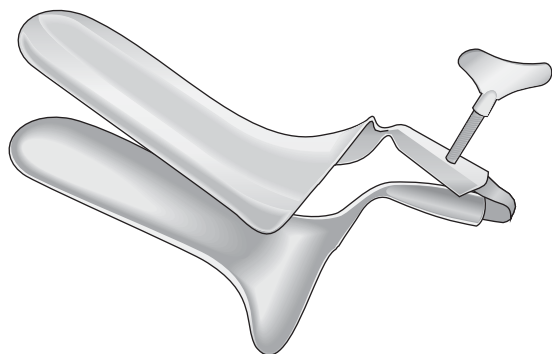

COLLIN-STANDARD
ER-72 Fig. 1 90x29 mm
ER-73 Fig. 2 95x35 mm
ER-74 Fig. 3 110x40 mm

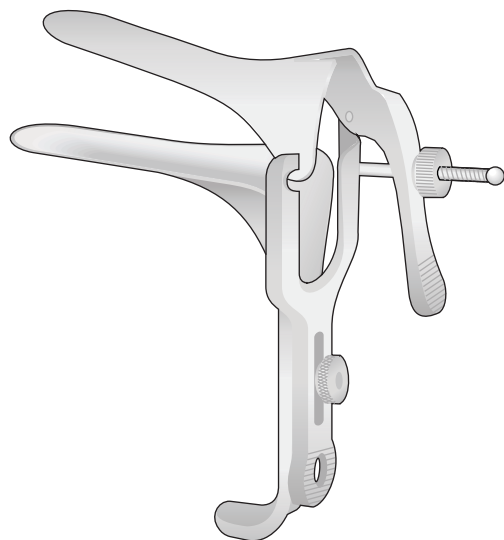

GRAVE
ER-91 75x20 mm
ER-92 95x30 mm
ER-93 105x33 mm

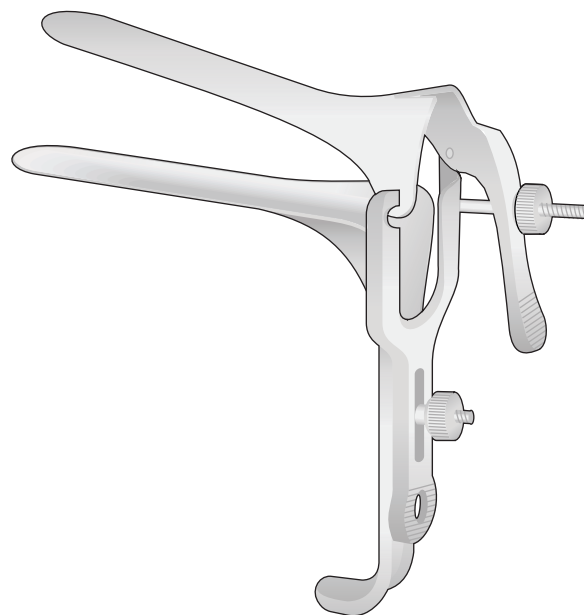

PEDERSON
ER-96 100x22 mm
ER-97 120x25 mm



Speculum
Spekula
Specula
Spéculums
Espéculos



KRISTELLER
Fig. 1 **EB-120** - 70 x 27 mm
Fig. 2 **EB-121** - 75 x 30 mm
Fig. 3 **EB-122** - 90 x 36 mm

Speculum
Spekula
Specula
Spéculums
Espéculos



KRISTELLER
Fig. 00 **EB-130** - 110 x 18 mm
Fig. 0 **EB-131** - 110 x 21 mm
Fig. 1 **EB-132** - 110 x 27 mm
Fig. 2 **EB-133** - 110 x 30 mm
Fig. 3 **EB-134** - 110 x 36 mm

Valva
Halter
Retractors
Valves
Valvas



KRISTELLER
Fig. 1 **EB-123** - 75 x 23 mm
Fig. 2 **EB-124** - 80 x 26 mm
Fig. 3 **EB-125** - 95 x 32 mm

Valva
Halter
Retractors
Valves
Valvas



KRISTELLER
Fig. 00 **EB-135** - 115 x 14 mm
Fig. 0 **EB-136** - 115 x 17 mm
Fig. 1 **EB-137** - 115 x 23 mm
Fig. 2 **EB-138** - 115 x 26 mm
Fig. 3 **EB-139** - 115 x 32 mm

Speculum + Valva
Specula + Retractor
Spekula + Halter
Spéculum + Valve
Espéculo + Valva



Fig. 1 **EB-126**
Fig. 2 **EB-127**
Fig. 3 **EB-128**

Speculum + Valva
Specula + Retractor
Spekula + Halter
Spéculum + Valve
Espéculo + Valva

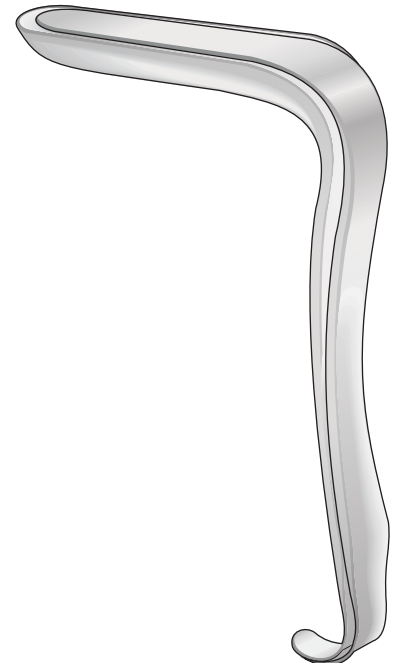
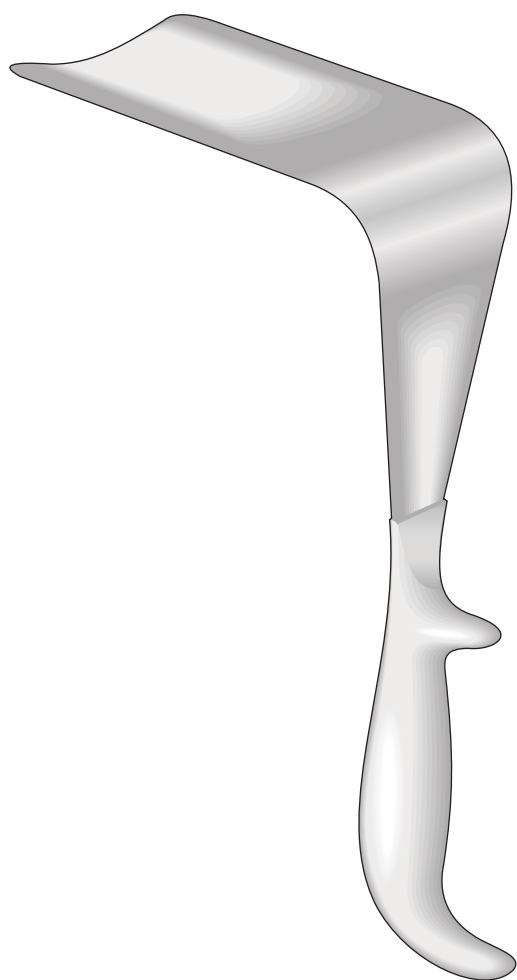

Fig. 00 **EB-140**
Fig. 0 **EB-141**
Fig. 1 **EB-142**
Fig. 2 **EB-143**
Fig. 3 **EB-144**



DOYEN
EB-150/EB-166
240 mm

Fig. 1 **EB-150** - 60 x 35 mm
Fig. 2 **EB-151** - 90 x 35 mm
Fig. 3 **EB-152** - 120 x 35 mm

Fig. 1 **EB-156** - 60 x 45 mm
Fig. 2 **EB-157** - 90 x 45 mm
Fig. 3 **EB-158** - 120 x 45 mm
Fig. 4 **EB-160** - 160 x 45 mm

Fig. 1 **EB-162** - 60 x 60 mm
Fig. 2 **EB-163** - 90 x 60 mm
Fig. 3 **EB-164** - 120 x 60 mm
Fig. 4 **EB-166** - 160 x 60 mm

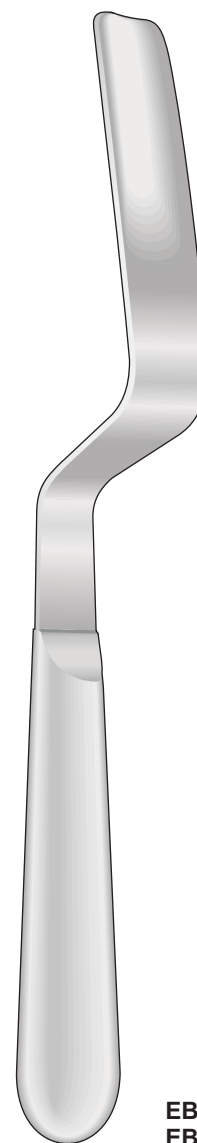

LANDAU
EB-190/EB-191
290 mm

EB-190 - 100 x 28 mm
EB-191 - 100 x 38 mm



BREISKY

EB-170 - 100 x 20 mm
EB-171 - 100 x 25 mm
EB-172 - 100 x 30 mm
EB-173 - 100 x 35 mm
EB-174 - 100 x 40 mm
 290 mm

BREISKY

EB-175 - 130 x 20 mm
EB-176 - 130 x 25 mm
EB-177 - 130 x 30 mm
EB-178 - 130 x 35 mm
EB-179 - 130 x 40 mm
 320 mm

BREISKY

EB-184 - 160 x 40 mm
 350 mm

BREISKY

EB-189 - 180 x 40 mm
 370 mm

Hegar Dilatatori - Hegar Dilatators - Hegar Dilatatoren - Hegar Dilateur - Hegar Dilatadores

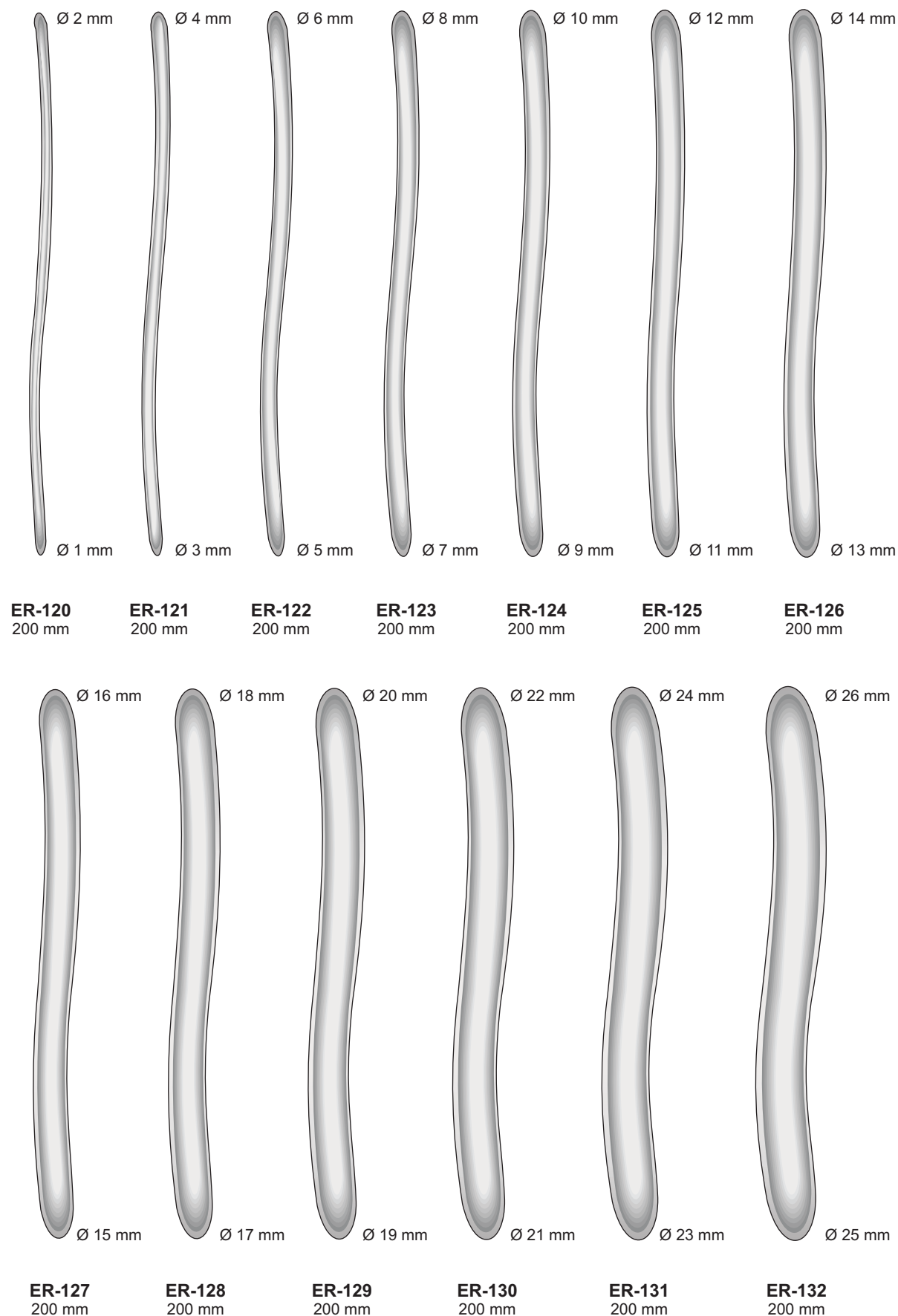

ER-110

Set completo dilatatori 8 pezzi
Set complete with 8 pieces
Satz-Dilatator, komplett, 8 Stück
Jeu complet avec 8 pieces
Juego completo con 8 piezas

Pratt Dilatori
Pratt Dilators
Pratt Dilatoren
Pratt Dilateur
Pratt Diladores

La misura è in French
Breite in French

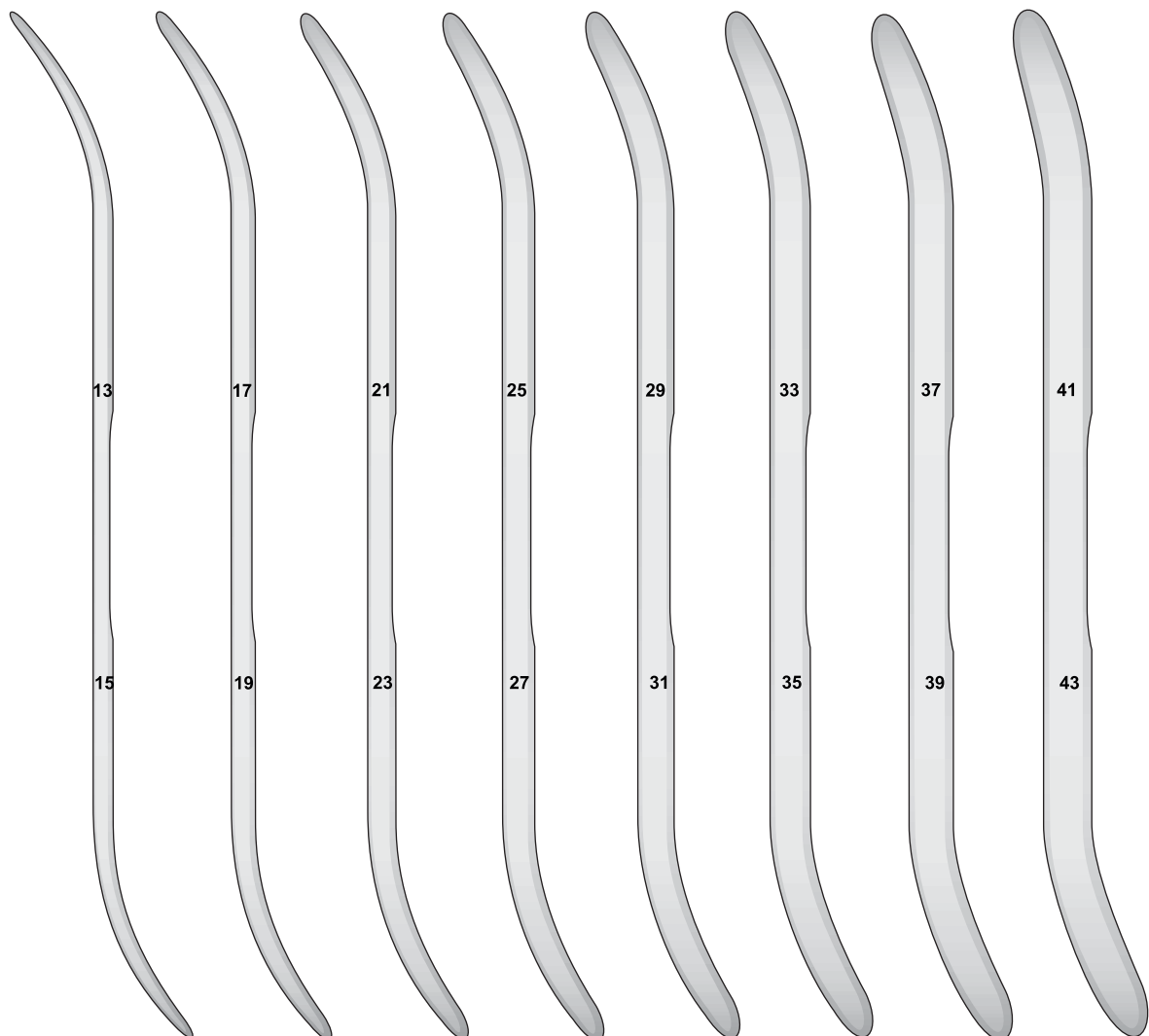

ER-111
260 mm

ER-112
260 mm

ER-113
260 mm

ER-114
260 mm

ER-115
260 mm

ER-116
260 mm

ER-117
260 mm

ER-118
260 mm

16



EB-51 1 mm
EB-52 2 mm
EB-53 3 mm
EB-54 4 mm
EB-55 5 mm
EB-56 6 mm
EB-57 7 mm
EB-58 8 mm
EB-59 9 mm
EB-60 10 mm
EB-61 11 mm
EB-62 12 mm
EB-63 13 mm

EB-64 14 mm
EB-65 15 mm
EB-66 16 mm
EB-67 17 mm
EB-68 18 mm
EB-69 19 mm
EB-70 20 mm
EB-71 21 mm
EB-72 22 mm
EB-73 23 mm
EB-74 24 mm
EB-75 25 mm
EB-76 26 mm

EB-77 1½ mm
EB-78 2½ mm
EB-79 3½ mm
EB-80 4½ mm
EB-81 5½ mm
EB-82 6½ mm
EB-83 7½ mm
EB-84 8½ mm
EB-85 9½ mm
EB-86 10½ mm
EB-87 11½ mm
EB-88 12½ mm
EB-89 13½ mm

EB-90 14½ mm
EB-91 15½ mm
EB-92 16½ mm
EB-93 17½ mm

HEGAR
EB-51/EB-93
 185 mm

Fig. 9/10
Ø 4,5/5,0 mm

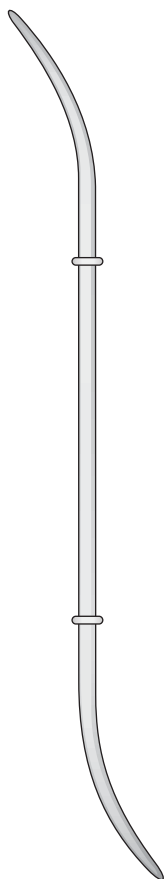

HANK
ER-161
 260 mm

Fig. 11/12
Ø 5,5/6,0 mm

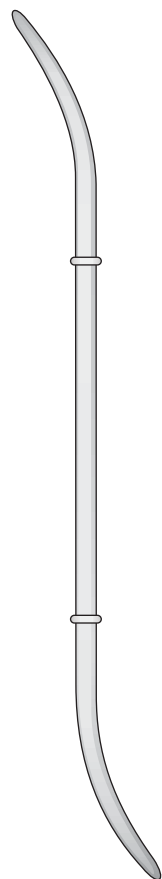

HANK
ER-162
 260 mm

Fig. 13/14
Ø 6,5/7,0 mm

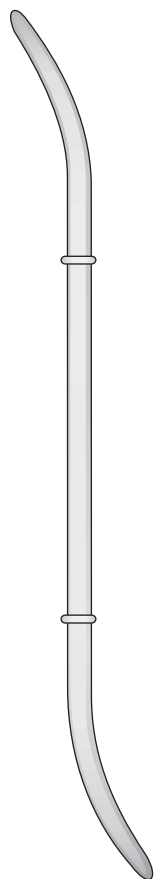

HANK
ER-163
 260 mm

Fig. 15/16
Ø 7,5/8,0 mm

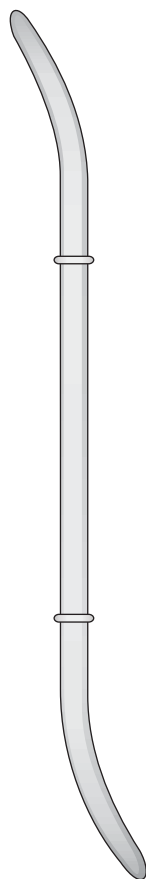

HANK
ER-164
 260 mm

Fig. 17/18
Ø 8,5/9,0 mm

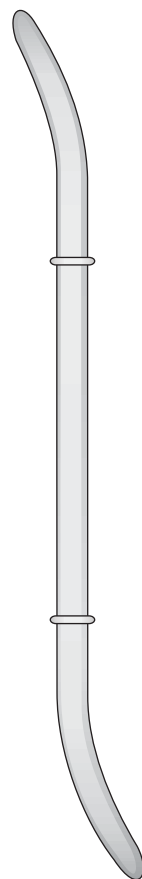

HANK
ER-165
 260 mm

Fig. 19/20
Ø 9,5/10 mm

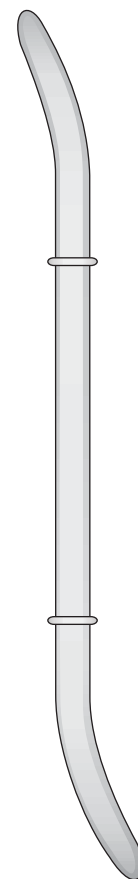

HANK
ER-166
 260 mm

Graduati in centimetri
 Graduated in centimeters
 Zentimetereinteilung
 Gradué en centimètres
 Graduado en centímetros

Malleabile
 Malleable
 Biagsam
 Malléables
 Maleables

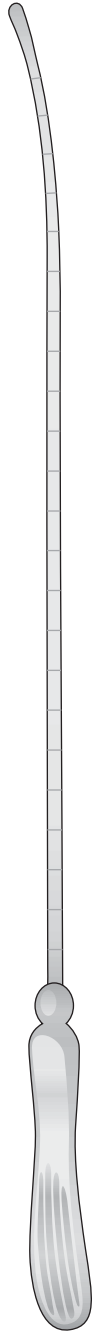

SIMS
ER-100/ER-102
 320 mm

Malleabile
 Malleable
 Biagsam
 Malléables
 Maleables

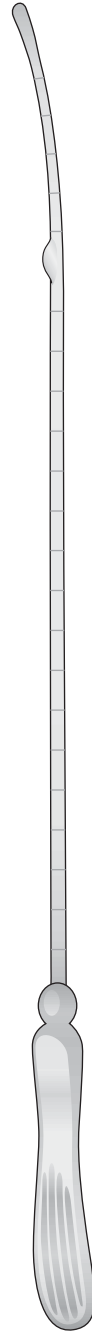

SIMPSON
ER-103 Ø 3 mm
 320 mm

Rigido
 Rigid
 Fest
 Rigides
 Rígidos

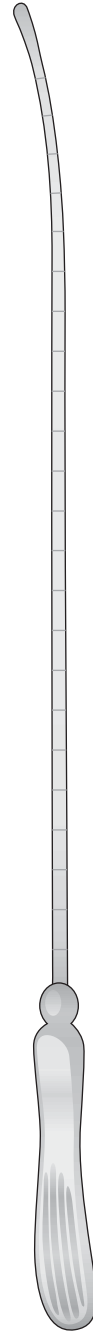

SIMS
ER-104/ER-105
 320 mm



VALLEIX
ER-107 Ø 4 mm
 265 mm

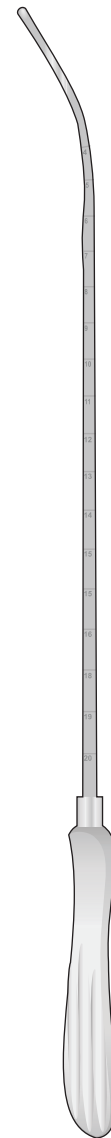

MARTIN
ER-106 Ø 3 mm
 300 mm

Malleabile
 Malleable
 Biagsam
 Malléables
 Maleables



MAYO
ER-108 Ø 5 mm
 330 mm

Amniotomo per la
vescica amniotica
Amniotome for the
amniotic bladder
Amniotom für die
Amnionblase
Amniotome pour la
vésicule amniotique
Amniotomo para la
vesícula amniótica

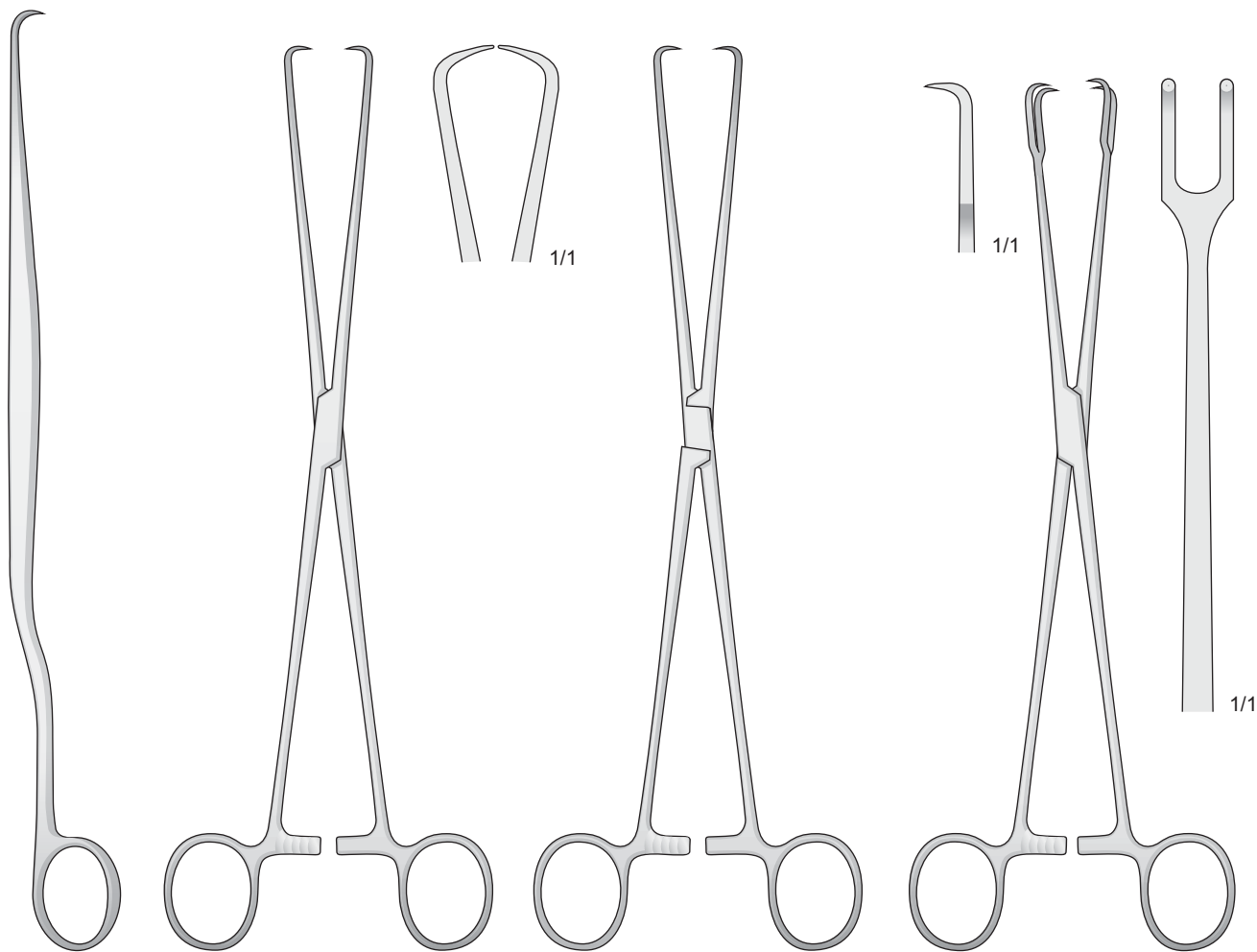

BEACHAM
BF-55
260 mm

BRAUN
BF-49
250 mm

POZZI
BF-60
250 mm

SCHROEDER
BF-59
240 mm

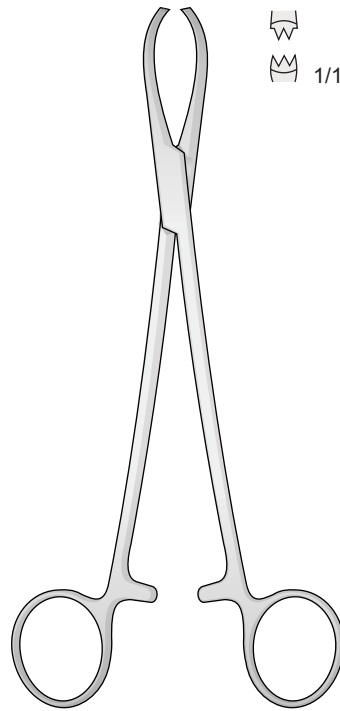

LITTLEWOOD
EB-25
185 mm

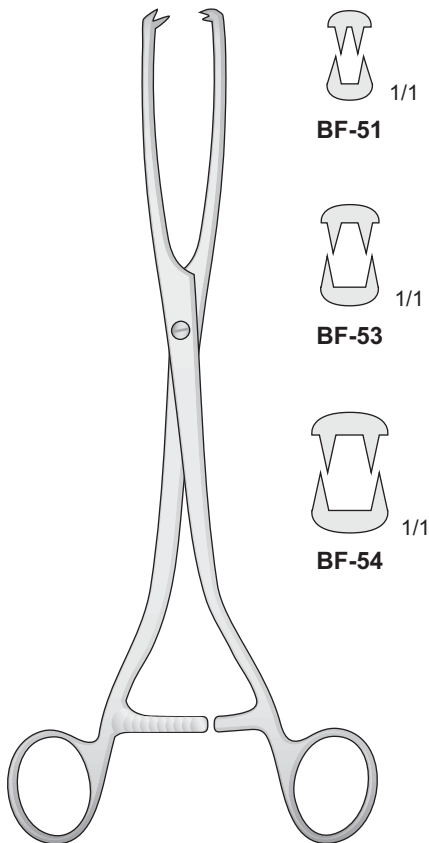

MUSEUX
BF-51/BF-54
240 mm

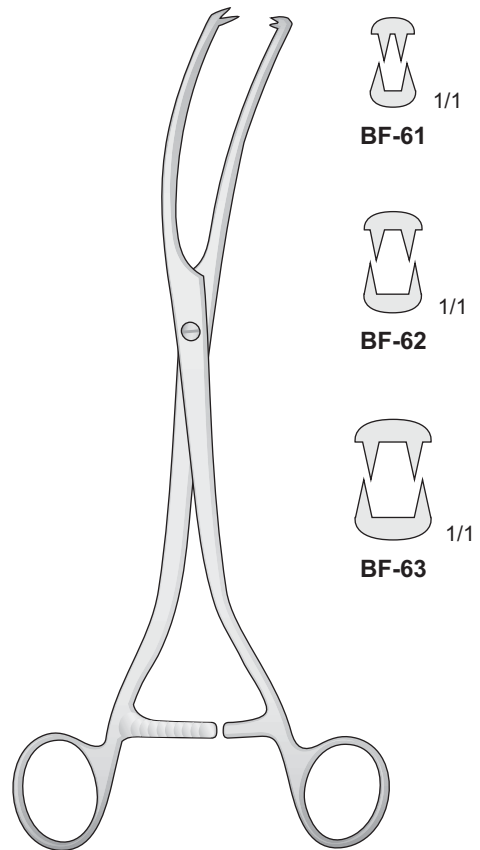

MUSEUX
BF-61/BF-63
240 mm

Curette per biopsia endouterina
Endometrical Biopsy curette
Endometrium-Strickkürette
Curette pour biopsie intra-utérines
Cureta para biopsia endo-uterina

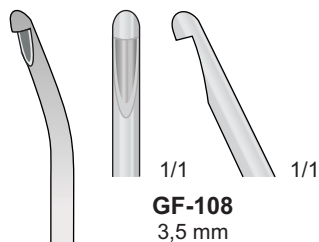

GF-108
3,5 mm

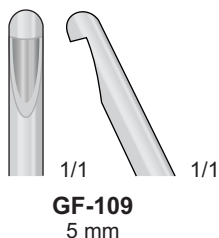

GF-109
5 mm

MÜNCHEN
GF-108/GF-109
270 mm

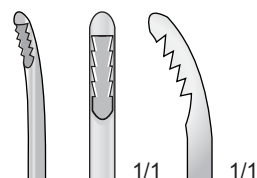

GF-135
Ø 1 mm
GF-136
Ø 2 mm
GF-137
Ø 3 mm
GF-138
Ø 4 mm

NOVAK
GF-135/GF-138
230 mm

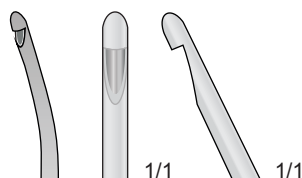

RANDALL
GF-139
230 mm

Curette per biopsia endocervicale
Endocervical Biopsy Curettes
Endocervix-Biopsieküretten

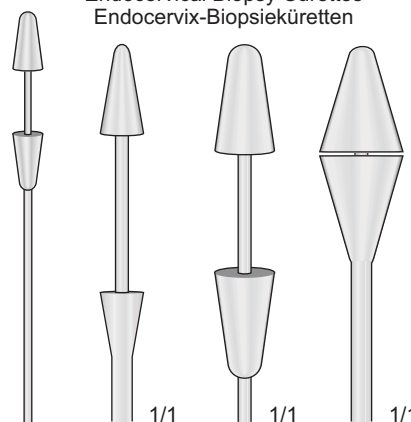

ER-77 Ø 5,7 mm
ER-78 Ø 8 mm
ER-79 Ø 11 mm

GUSBERG
ER-77/ER-79
240 mm

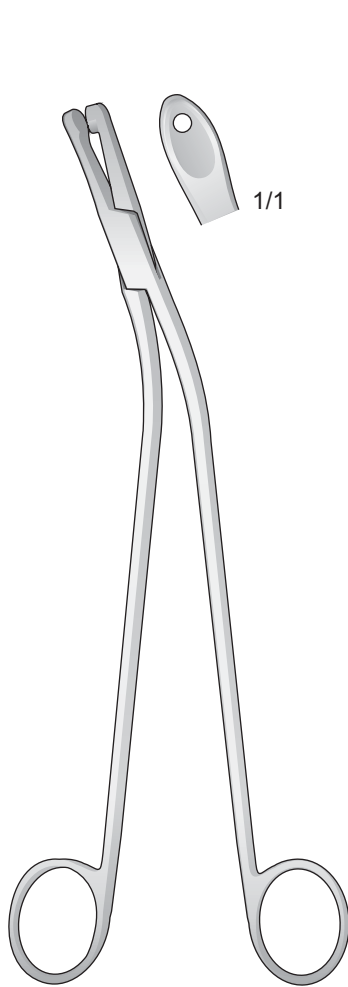

GELLHORN
FF-30
230 mm

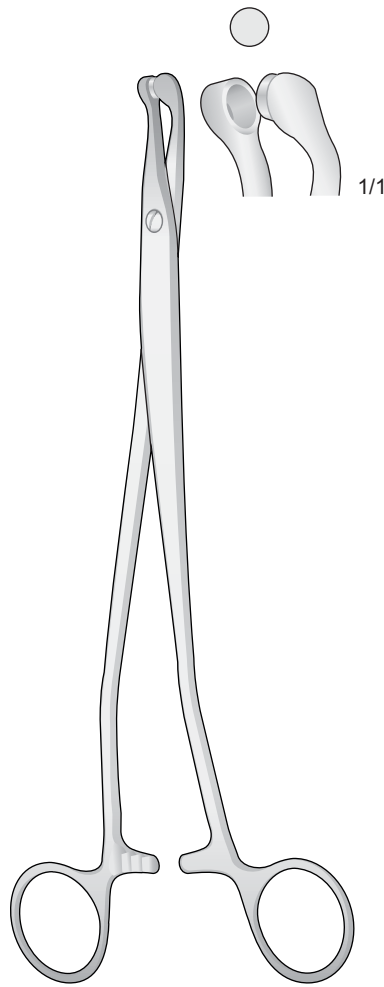

THOMS-GAYLOR
FF-32
240 mm

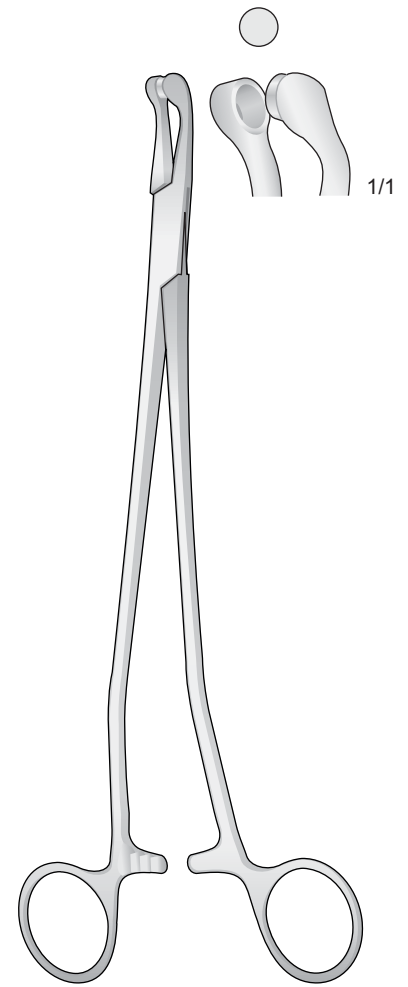

THOMS-GAYLOR
FF-33 220 mm
FF-34 240 mm

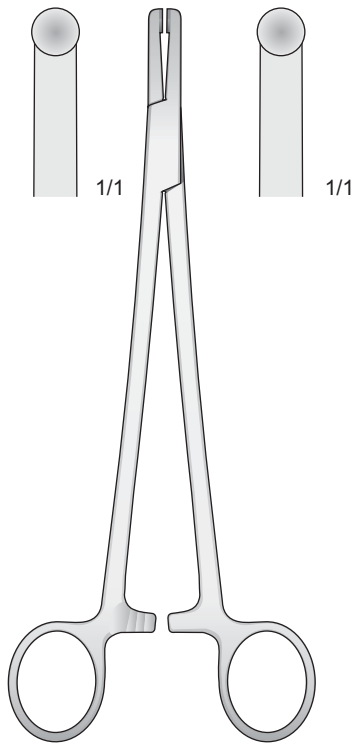

DB-150
205 mm

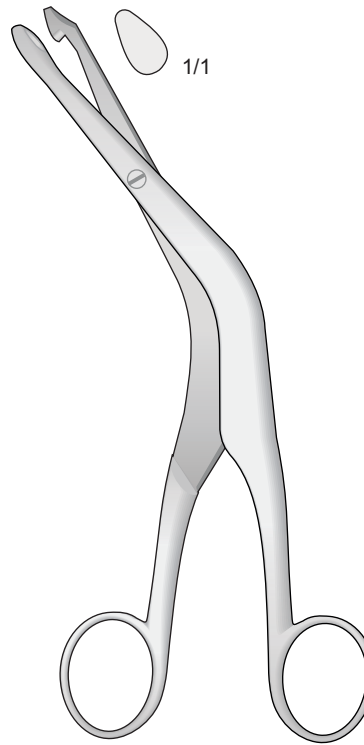

**FAURE
FF-31**
210 mm

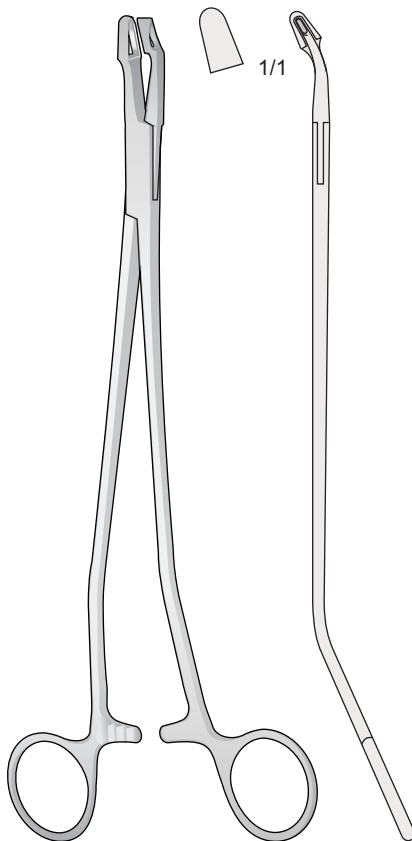

**VAN DOREN
FF-39**
250 mm

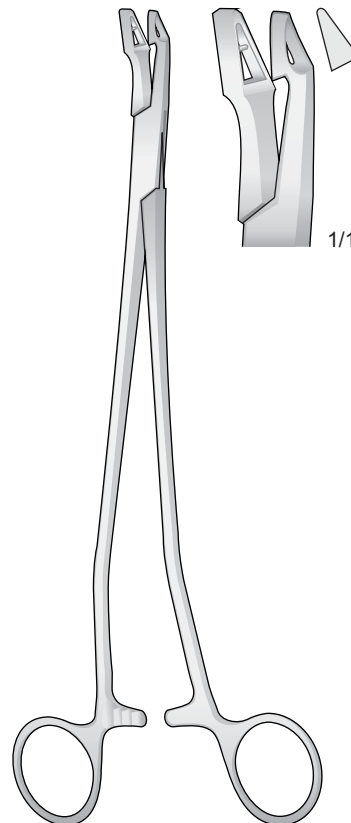

**VAN DOREN
FF-38**
240 mm

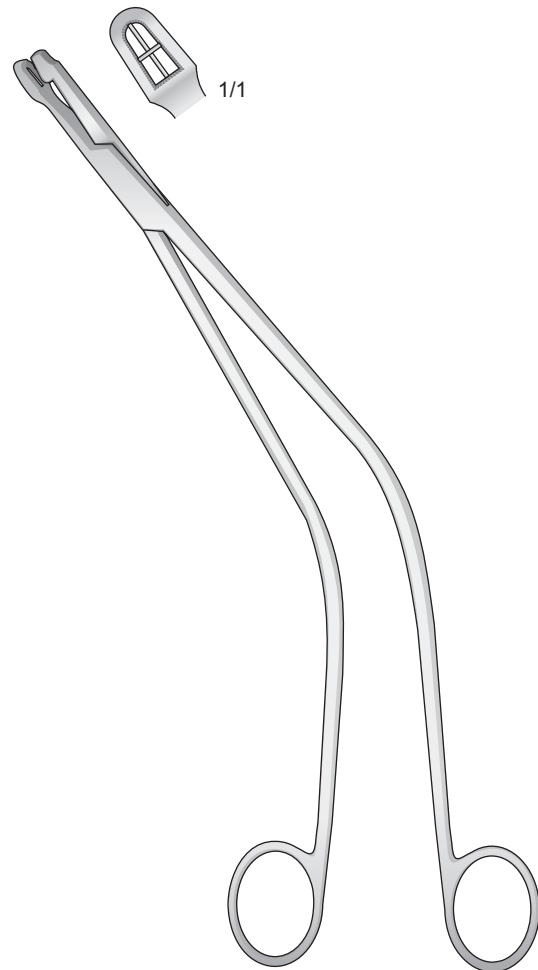
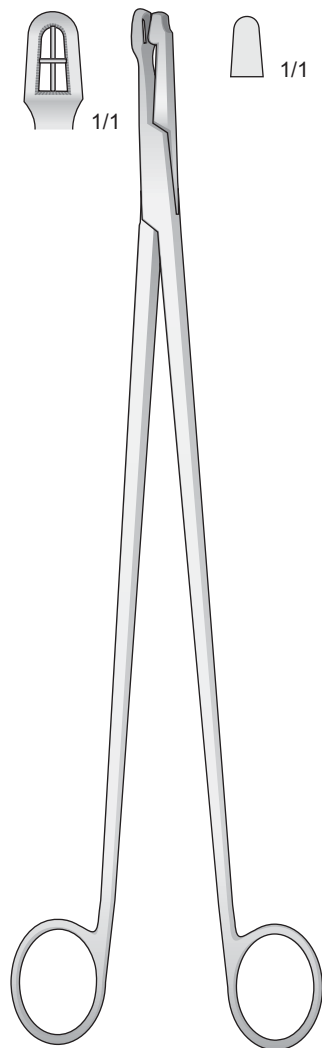
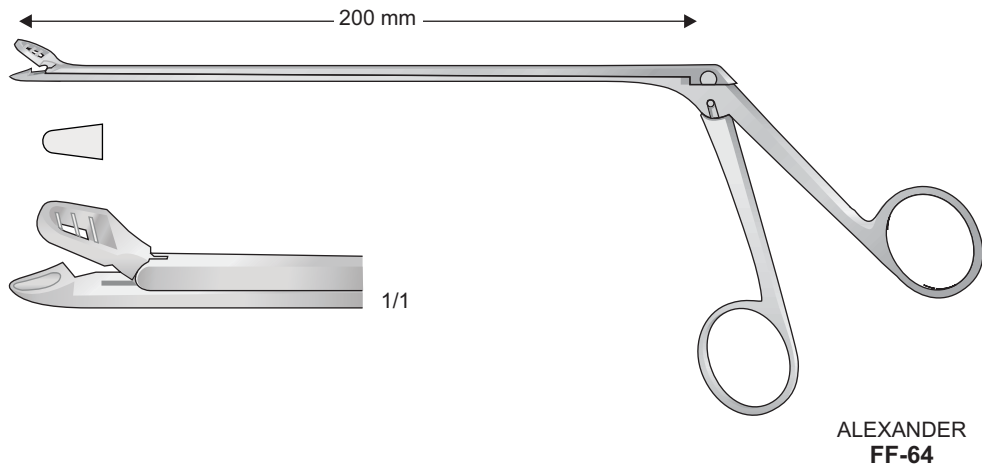

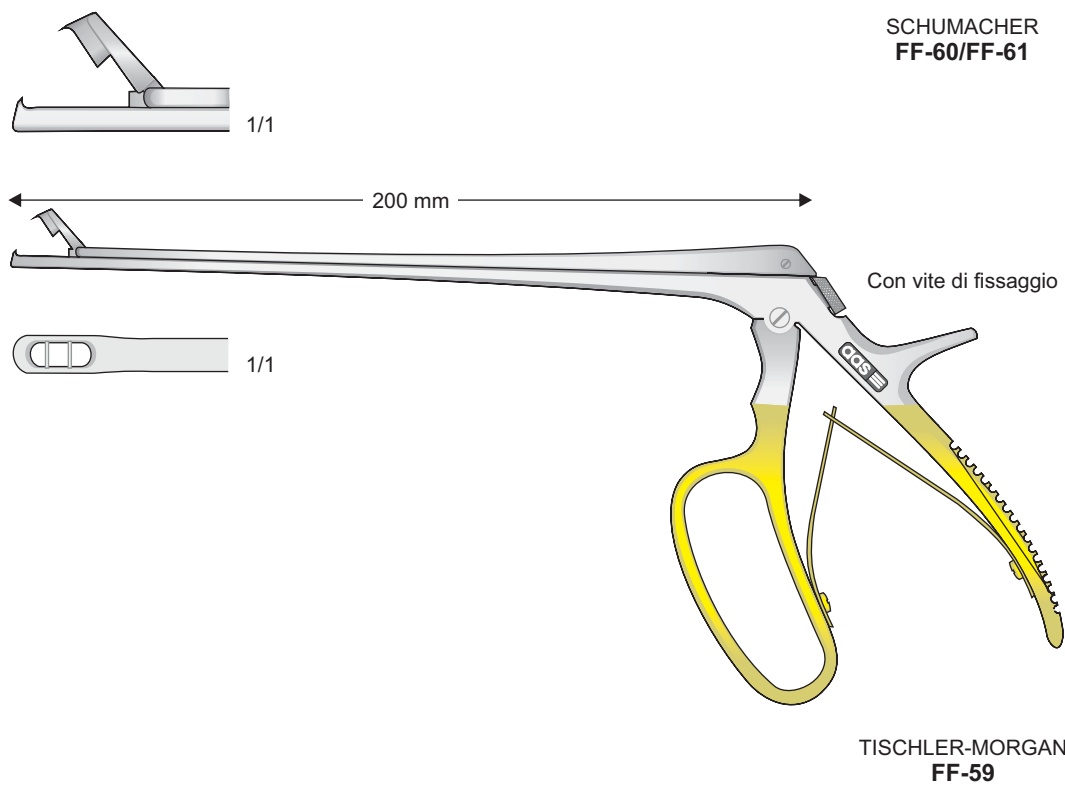
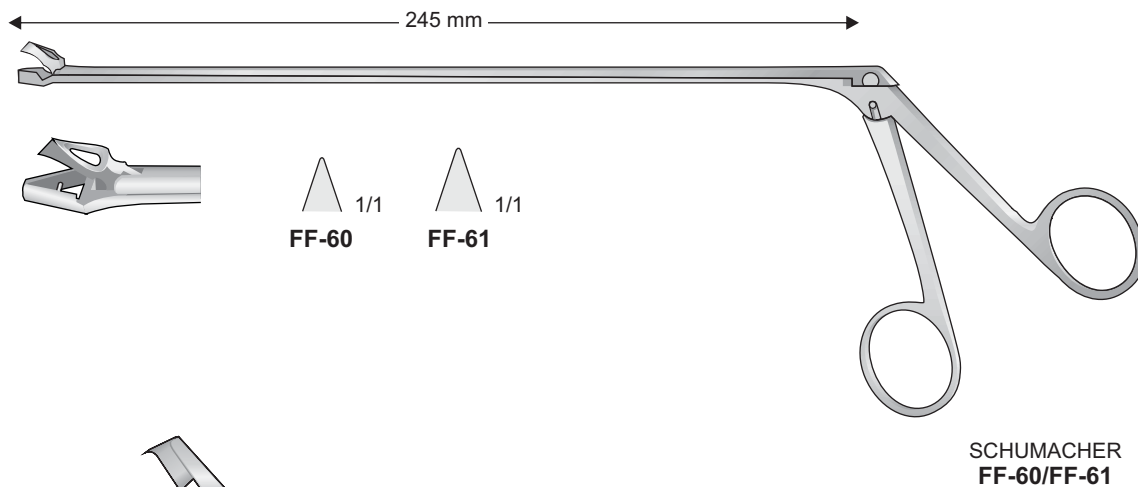
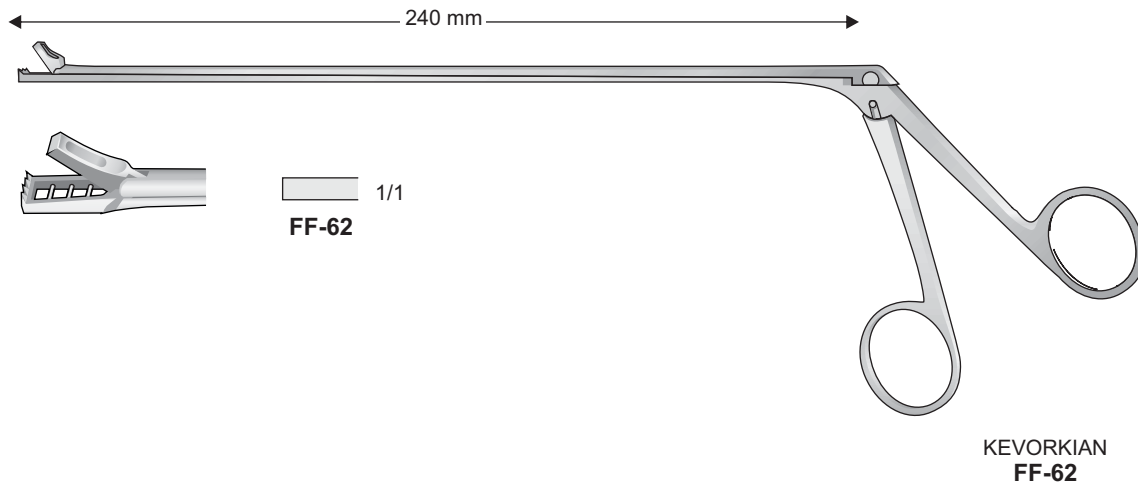

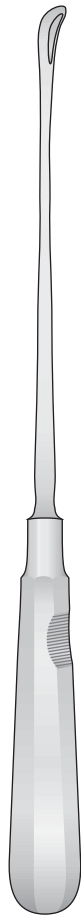

LUER-KÖRTE
EB-21/EB-23
260 mm

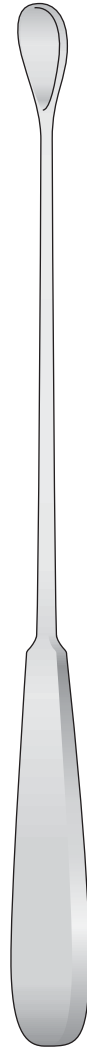
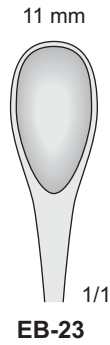
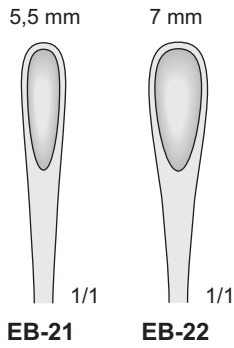

GOURDET
ER-80/ER-84
280 mm

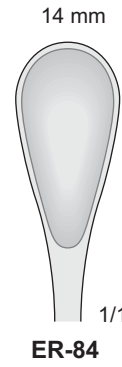
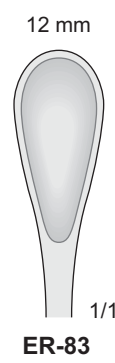
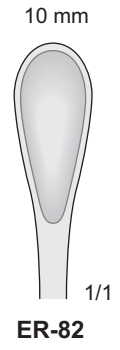
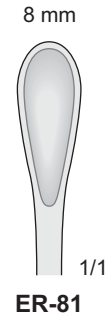
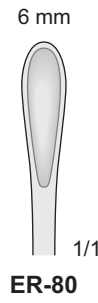



WALLICH
ER-90
420 mm

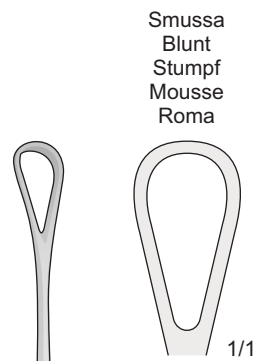

BLAKE
ER-88
275 mm



Taglienti
Scharp
Scharf
Tranchantes
Cortantes

Smussa
Blunt
Stumpf
Mousse
Romas

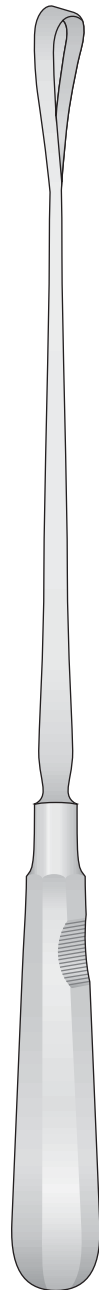

RECAMIER
ER-11/ER-28
310 mm

Fig. 1

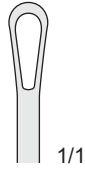

1/1

Fig. 2

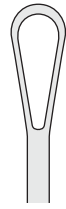

1/1

Fig. 3



1/1

Fig. 4



1/1

Fig. 5

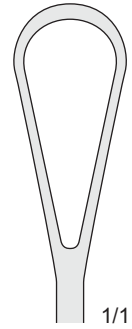

1/1

Fig. 6

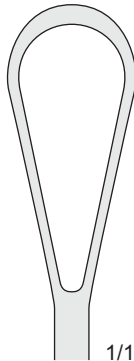

1/1

Fig. 7

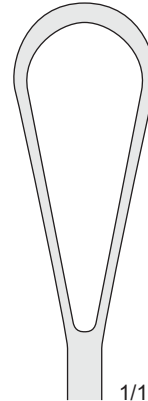

1/1

Fig. 8

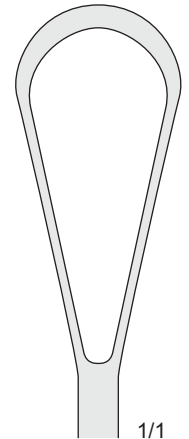

1/1

Fig.	Larghezza Width Breite	Taglienti-rigide Sharp-rigid Scharf-fest Tranchantes-rigides Cortantes-rigidas	Smusse-rigide Blunt-rigid Stumpf-fest Mousse-rigides Romas-rigidas
1	4 mm	ER-11	ER-21
2	6 mm	ER-12	ER-22
3	8 mm	ER-13	ER-23
4	10 mm	ER-14	ER-24
5	12 mm	ER-15	ER-25
6	14 mm	ER-16	ER-26
7	16 mm	ER-17	ER-27
8	18 mm	ER-18	ER-28

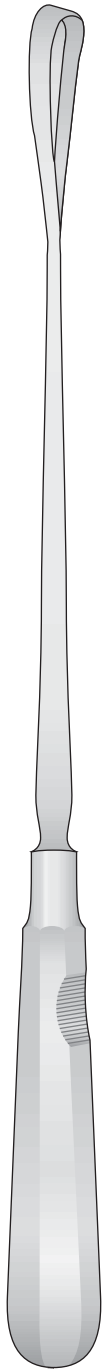

BUMM
ER-31/ER-42
310 mm

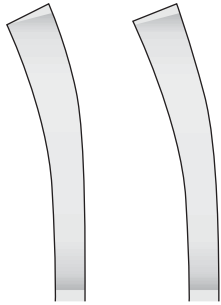

Tagliente
Scharp
Scharf
Tranchantes
Cortantes

Smussa
Blunt
Stumpf
Mousse
Romas

Malleabile
Malleable
Biegsam
Souples
Maleables

Fig. 3

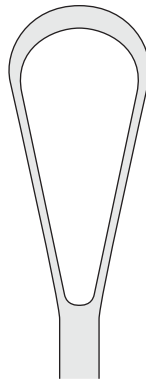
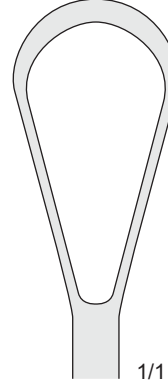

Fig. 4



1/1

Fig. Larghezza
Width
Breite

Taglienti
Sharp
Scharf
Tranchantes
Cortantes

Smusse
Blunt
Stumpf
Mousse
Romas

3	18 mm	ER-31	ER-41
4	20 mm	ER-32	ER-42

Fig.	Larghezza Breite Width	Smusse malleabili - Blunt malleable Stumpf biegsam - Mousse malléables Romas maleables
0	16 mm	ER-140
1	18 mm	ER-141
2	19,5 mm	ER-142
3	21,5 mm	ER-143
4	23,5 mm	ER-144
5	26 mm	ER-145
6	28,5 mm	ER-146

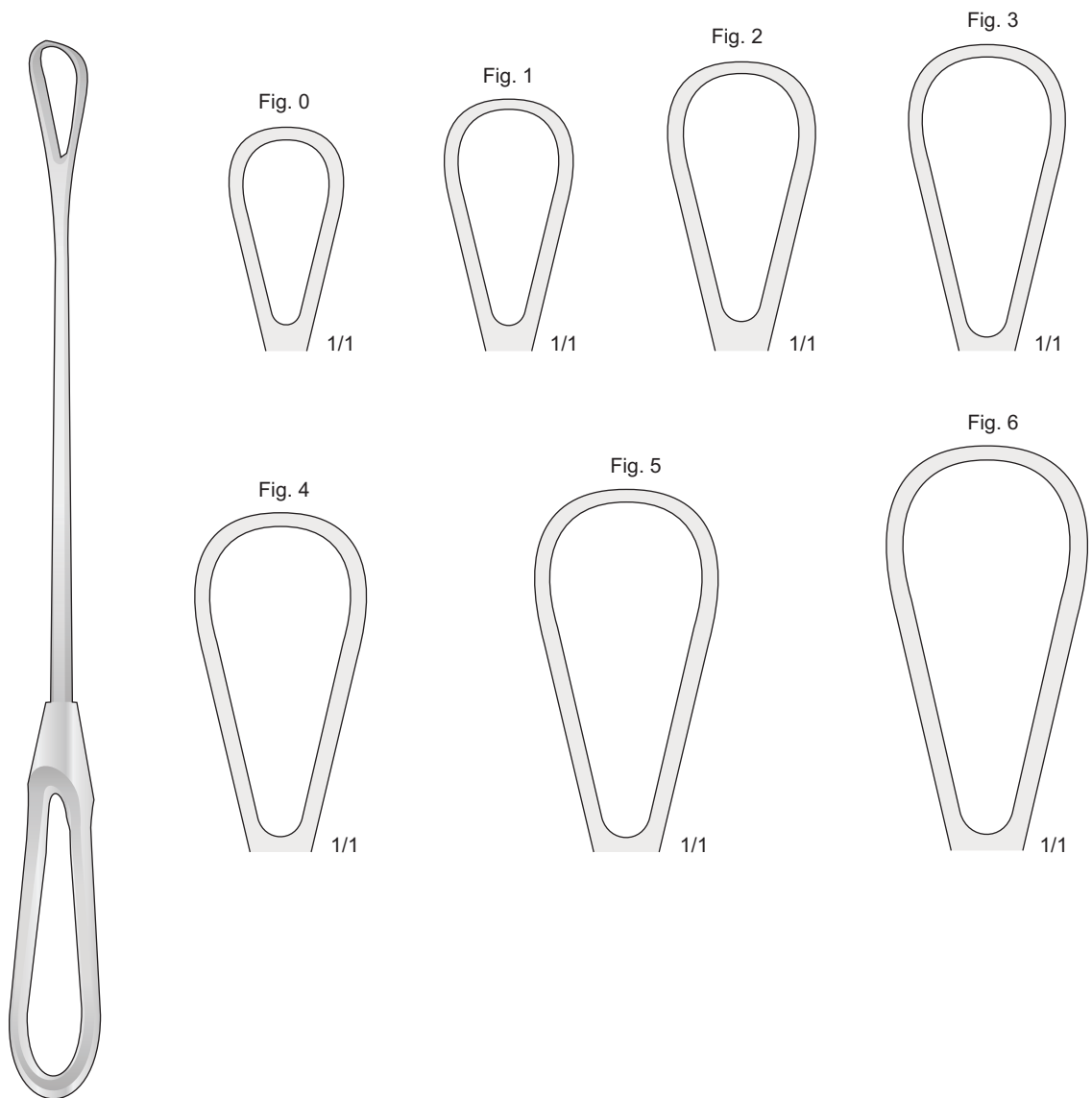

BUMM
ER-140/ER-146
290 mm

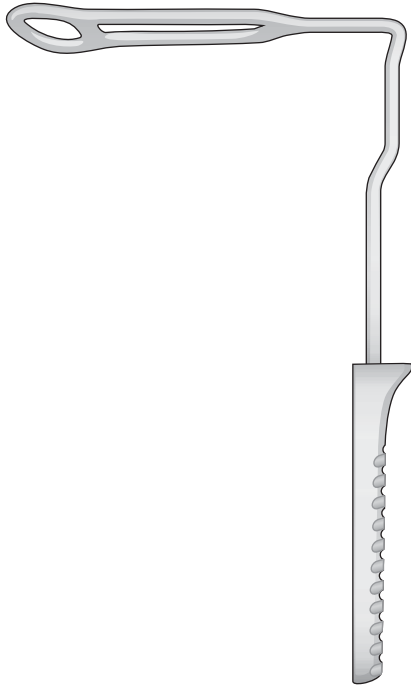

GENTOFT
ER-50
210 mm

Set 2 pezzi
Set 2 pieces
Set 2 Stück
Set 2 pièces
Set 2 piezas
ER-50 + ER-51



FENO
ER-51
230 mm

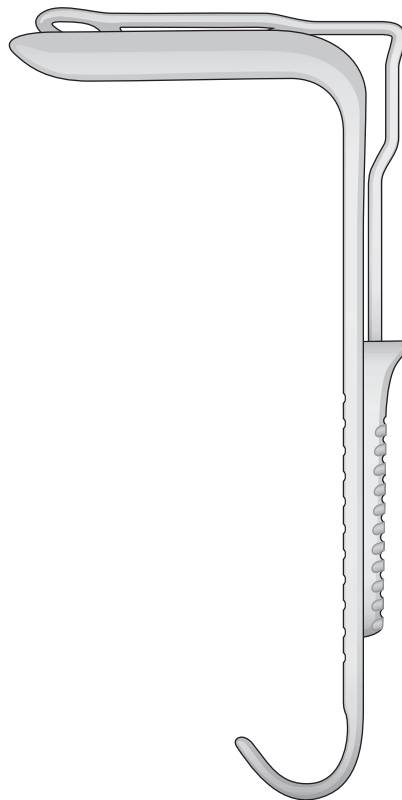

ER-53
230 mm

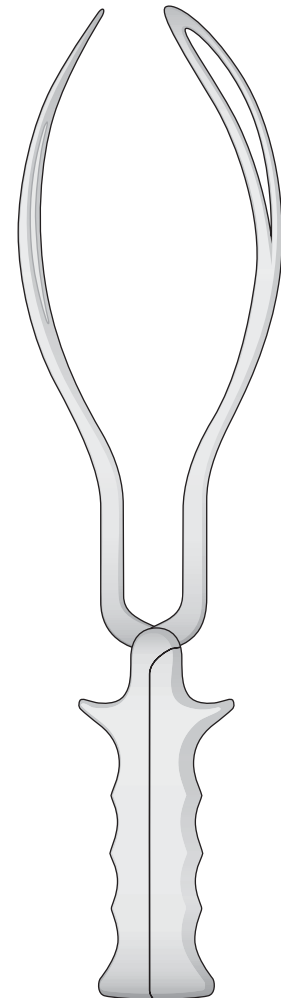

SIMPSON-BRAUN
ER-52
365 mm



17

Suction Tubes
Cannule
Saugkanülen
Canules d'aspiration
Cánulas de aspiración

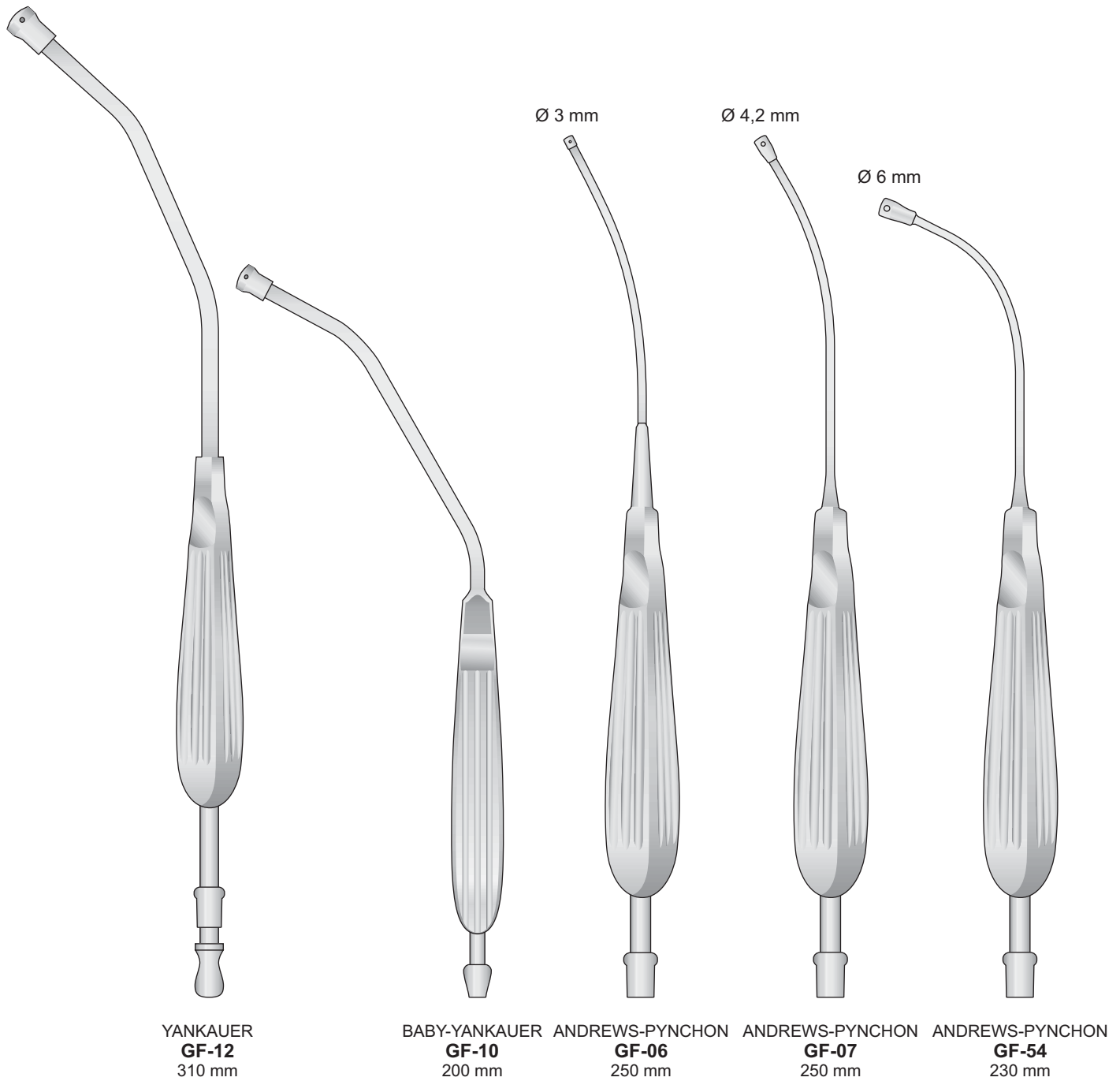

GF-129

Manico portacanule
Set - Satz - Jeu - Jeugo

Completo con 4 canule
Complet with 4 tubes
Komplett mit 4 Kanülen
Complete avec 4 canules
Completo con 4 cànulas

GF-197

Manico portacanule
Set - Satz - Jeu - Jeugo

Completo con 3 canule
Complet with 3 tubes
Komplett mit 3 Kanülen
Complete avec 3 canules
Completo con 3 cànulas

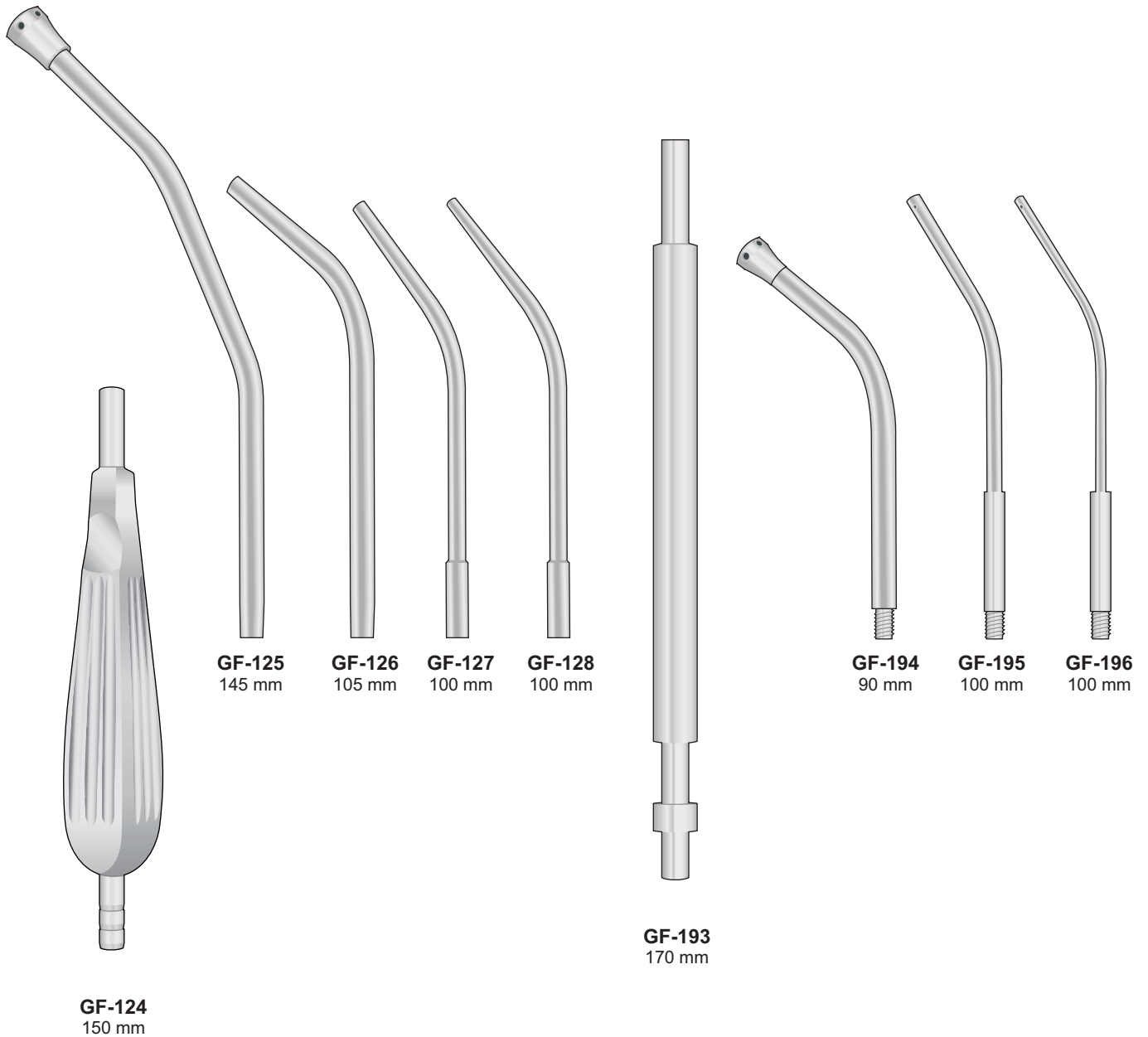

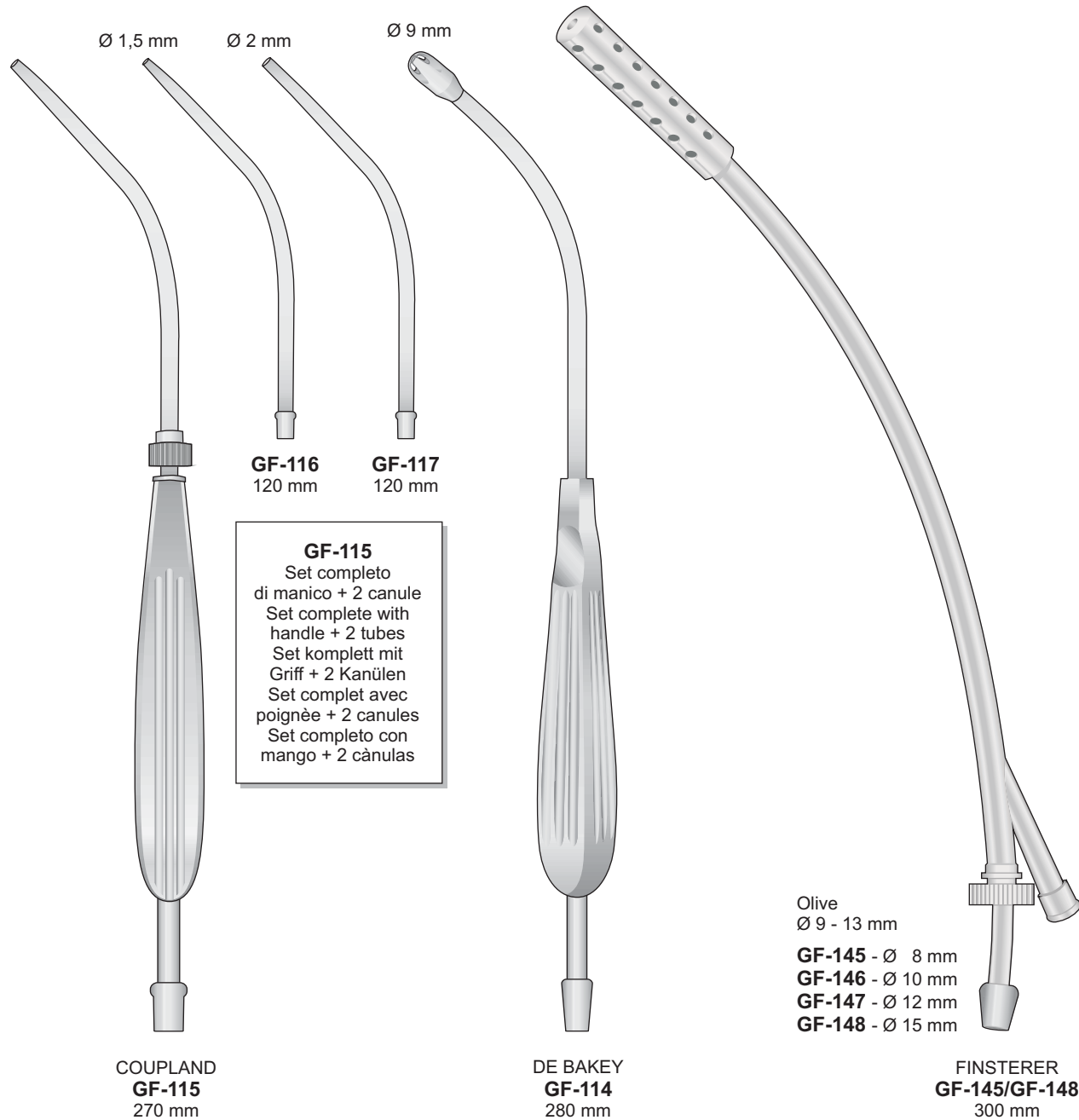

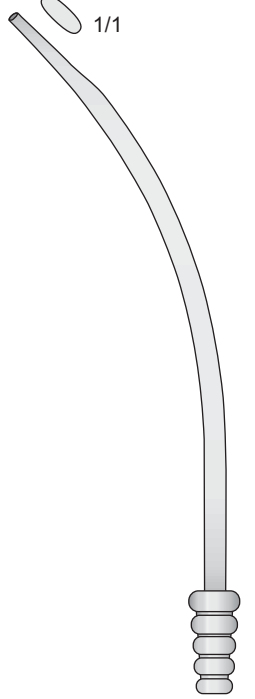

GF-20
180 mm

Ø 6 mm

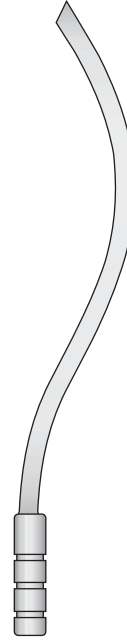

GF-09B
175 mm

Ø 9 mm

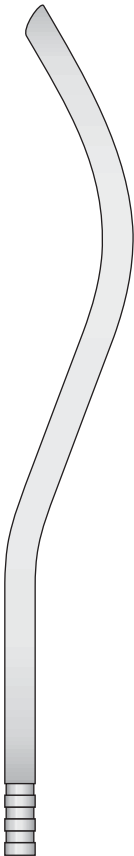

GF-09
230 mm

Ø 6 mm

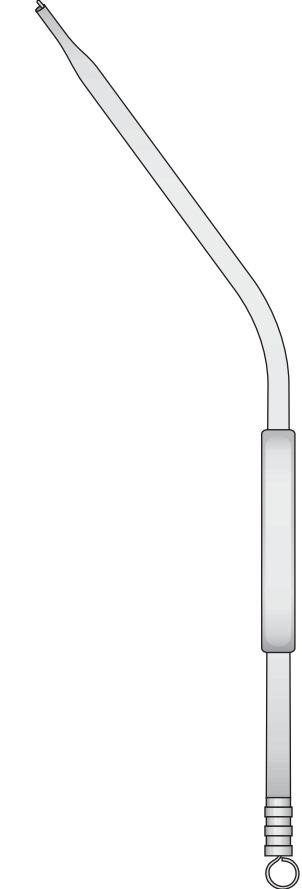

GF-104
240 mm

Ø 4 mm

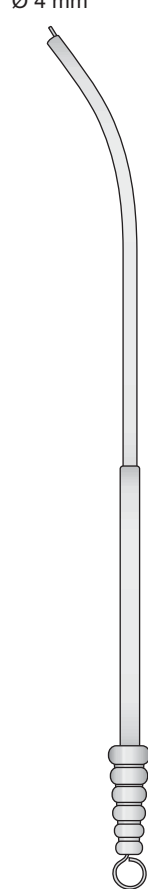

GF-110
230 mm

6 mm



Rotondo
Round
Rund
Ronde
Redonda



NUBOER GF-98
210 mm

6 mm



Ovale
Oval
Ovale
Ovale
Ovalada



NUBOER GF-99
210 mm

17

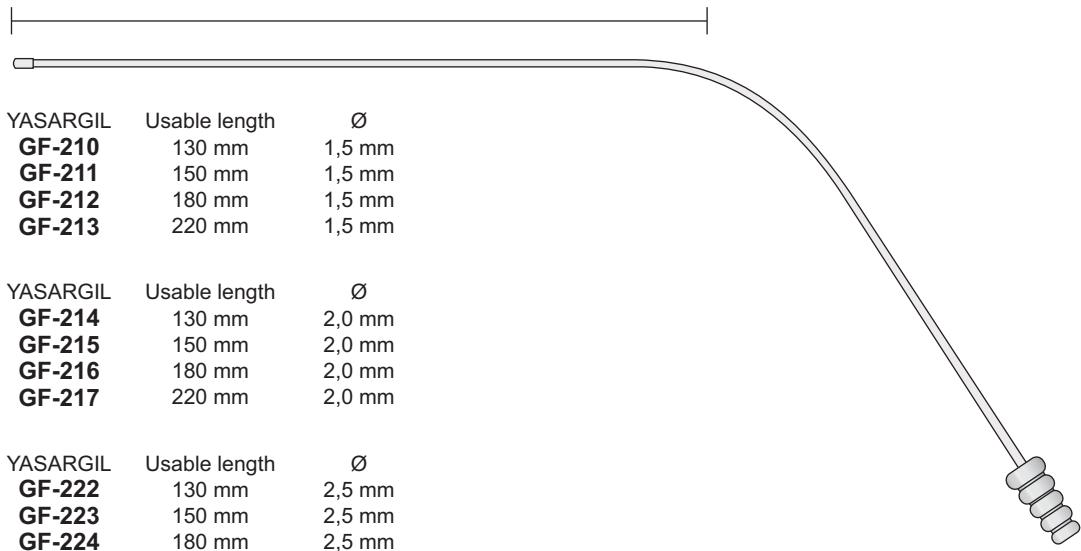

**YASARGIL
GF-210/GF-230**

YASARGIL	Usable length	Ø
GF-210	130 mm	1,5 mm
GF-211	150 mm	1,5 mm
GF-212	180 mm	1,5 mm
GF-213	220 mm	1,5 mm

YASARGIL	Usable length	Ø
GF-214	130 mm	2,0 mm
GF-215	150 mm	2,0 mm
GF-216	180 mm	2,0 mm
GF-217	220 mm	2,0 mm

YASARGIL	Usable length	Ø
GF-222	130 mm	2,5 mm
GF-223	150 mm	2,5 mm
GF-224	180 mm	2,5 mm
GF-225	220 mm	2,5 mm

YASARGIL	Usable length	Ø
GF-226	130 mm	3,5 mm
GF-227	150 mm	3,5 mm
GF-228	180 mm	3,5 mm
GF-229	220 mm	3,5 mm

YASARGIL	Usable length	Ø
GF-230	180 mm	4,5 mm

Nasensauger

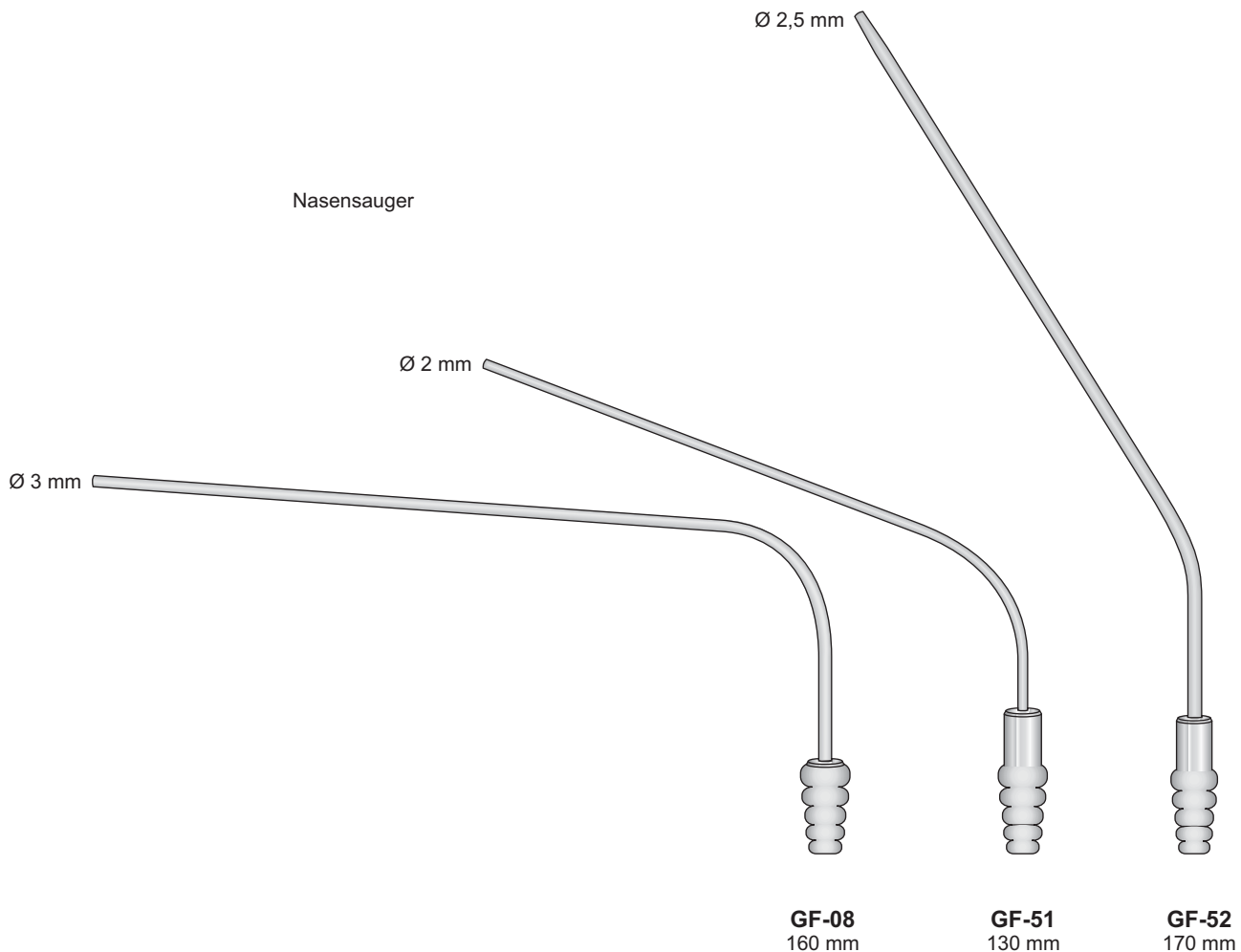

Char. 6	= 2 mm
Char 7	= 2,5 mm
Char 9	= 3 mm
Char 10	= 3,3 mm
Char 12	= 4 mm
Char 15	= 5 mm

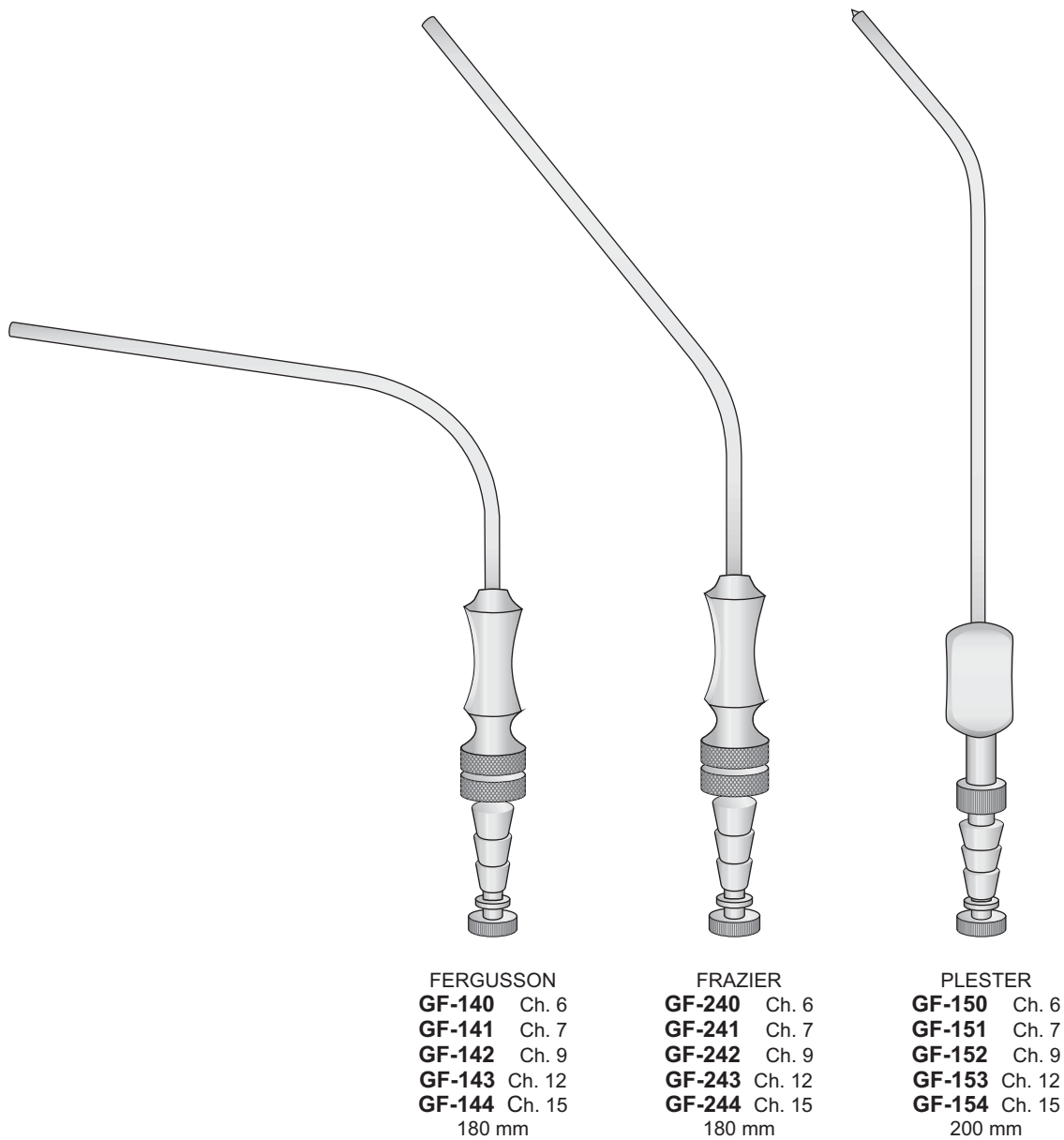

Char. 3	= 1 mm
Char 5	= 1,7 mm
Char 7	= 2,5 mm
Char 10	= 3,3 mm
Char 12	= 4 mm

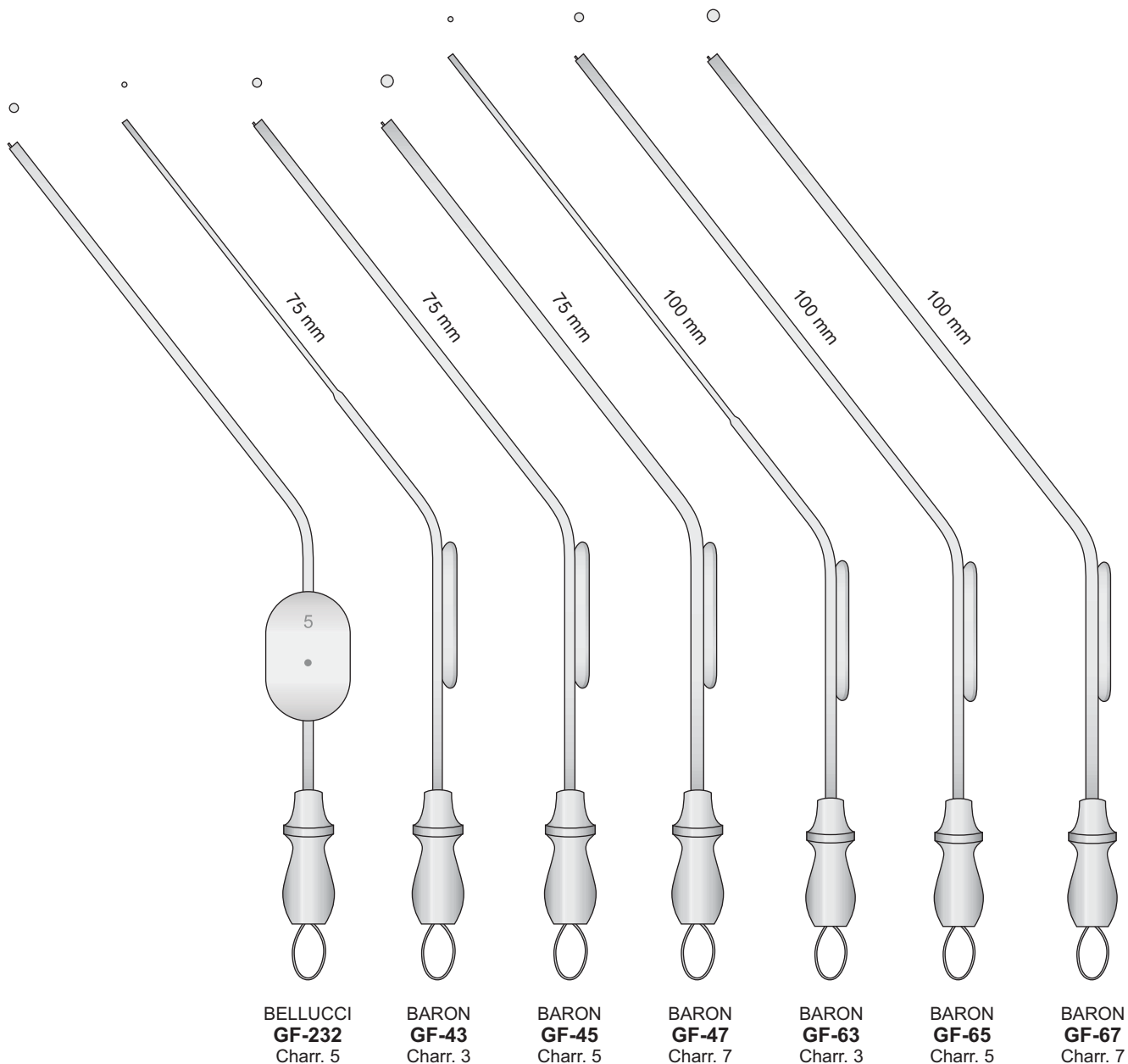

Char. 3	= 1 mm
Char 5	= 1,7 mm
Char 7	= 2,5 mm
Char 10	= 3,3 mm
Char 12	= 4 mm

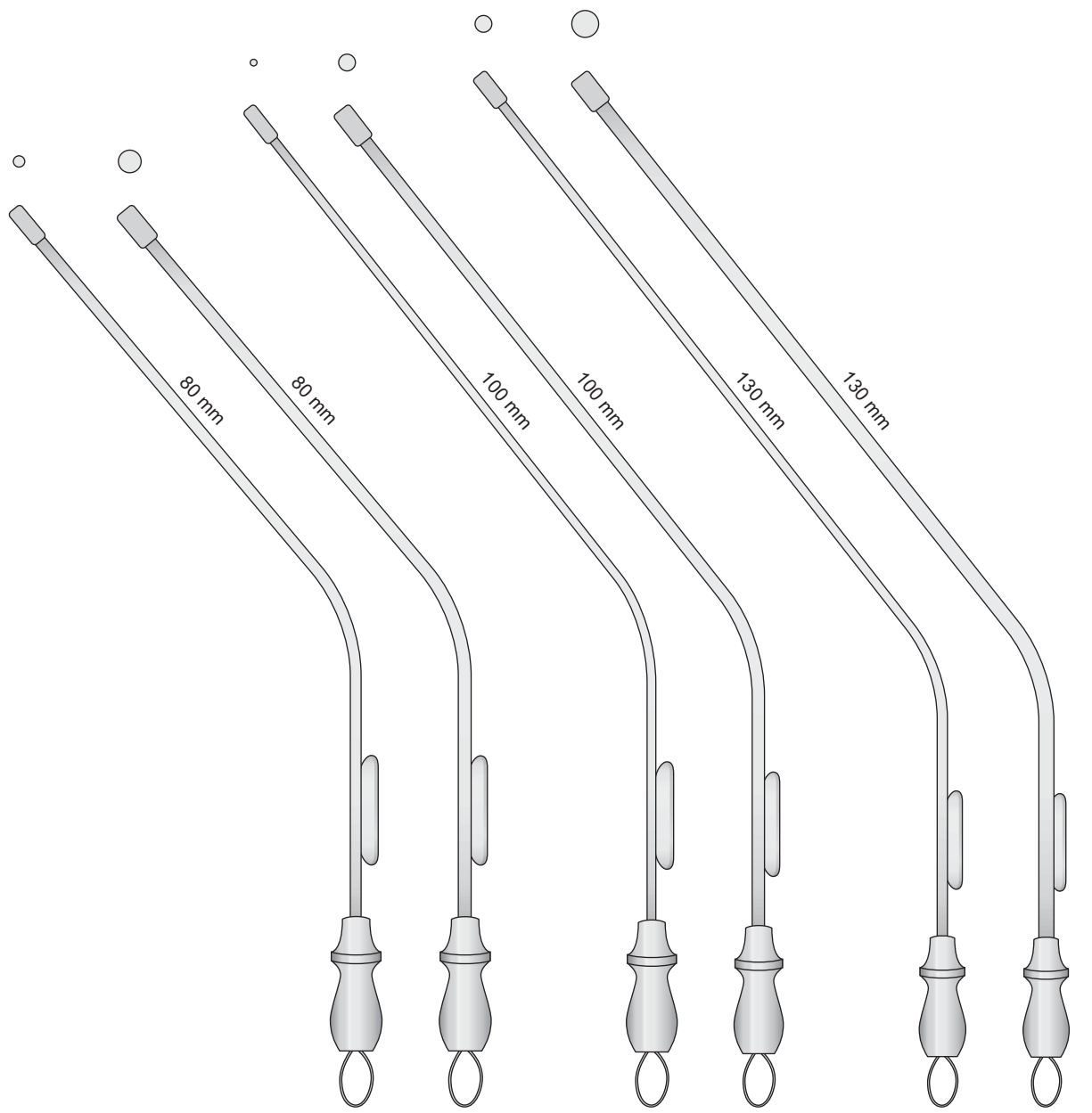

ROTAN
GF-21
Charr. 5

ROTAN
GF-26
Charr. 10

ROTAN
GF-25
Charr. 3

ROTAN
GF-27
Charr. 7

ROTAN
GF-28
Charr. 7

ROTAN
GF-24
Charr. 12

Char. 3	= 1 mm
Char 5	= 1,7 mm
Char 7	= 2,5 mm
Char 10	= 3,3 mm
Char 12	= 4 mm
Char 14	= 4,6 mm

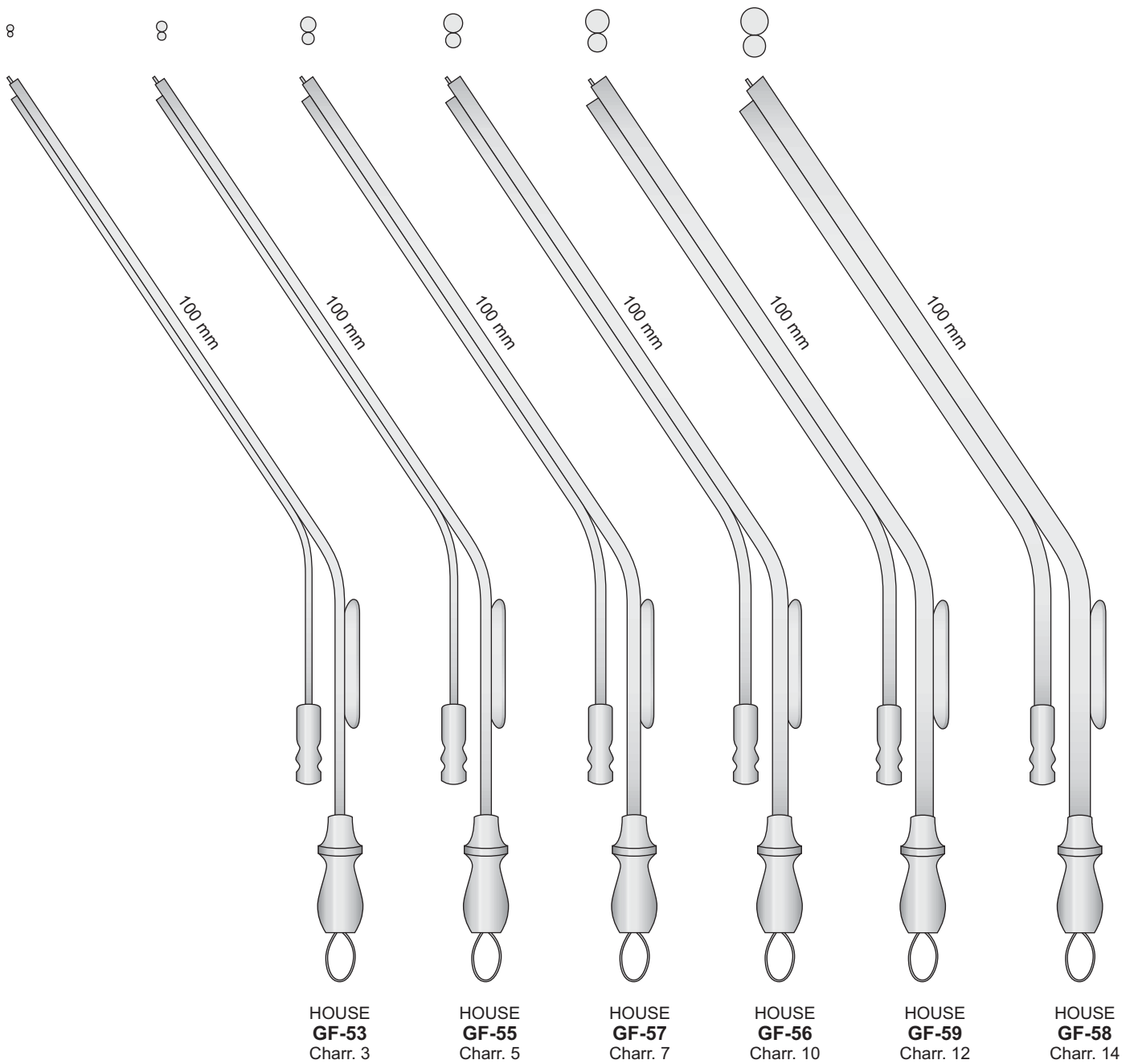

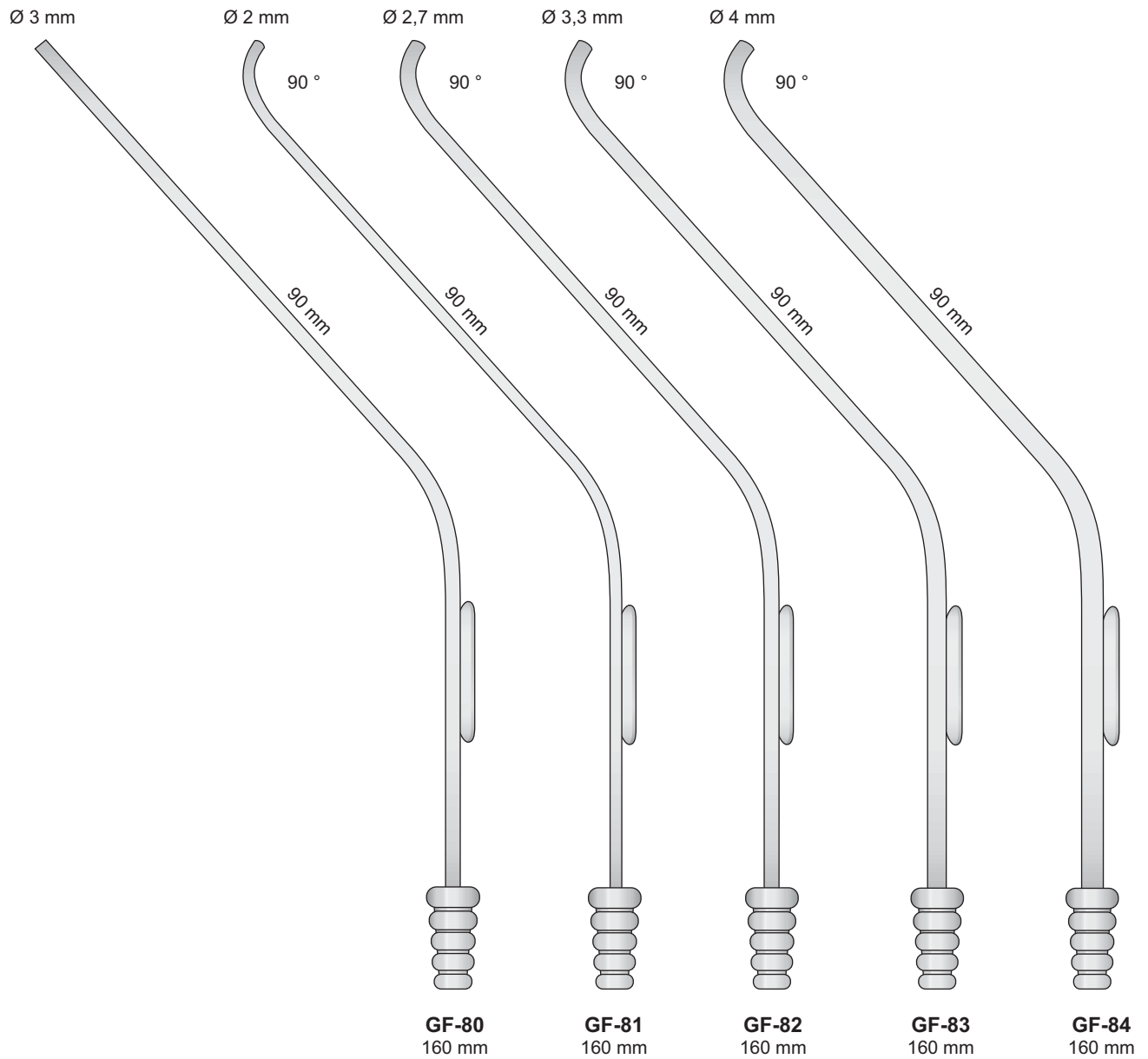

Cromata nera

Cromata nera

Malleabile
Malleable
Biigsam
Malleables
Malleable
Ø 3 mm

Malleabile
Malleable
Biigsam
Malleables
Malleable
Ø 3 mm

Malleabile
Malleable
Biigsam
Malleables
Malleable
Ø 3 mm

Malleabile
Malleable
Biigsam
Malleables
Malleable
Ø 3 mm

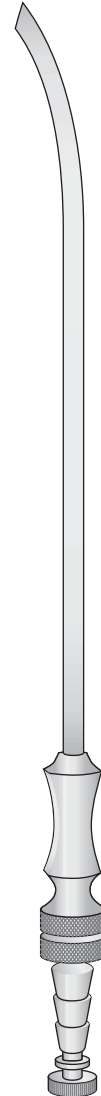
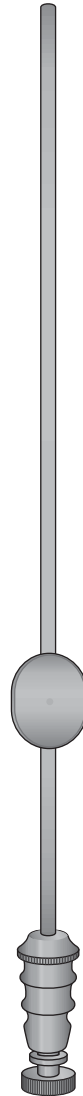
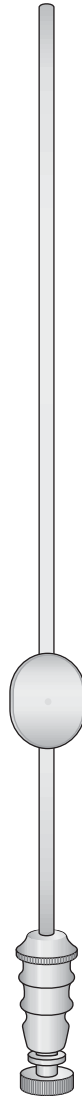
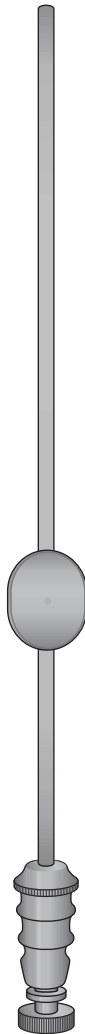
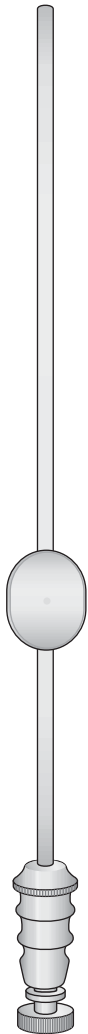

WERTHEIMER
GF-69
160 mm

FRAZIER
GF-70
160 mm

WERTHEIMER
GF-60
200 mm

FRAZIER
GF-61
200 mm

ADSON
GF-41 ch. 12
GF-42 ch. 15
210 mm

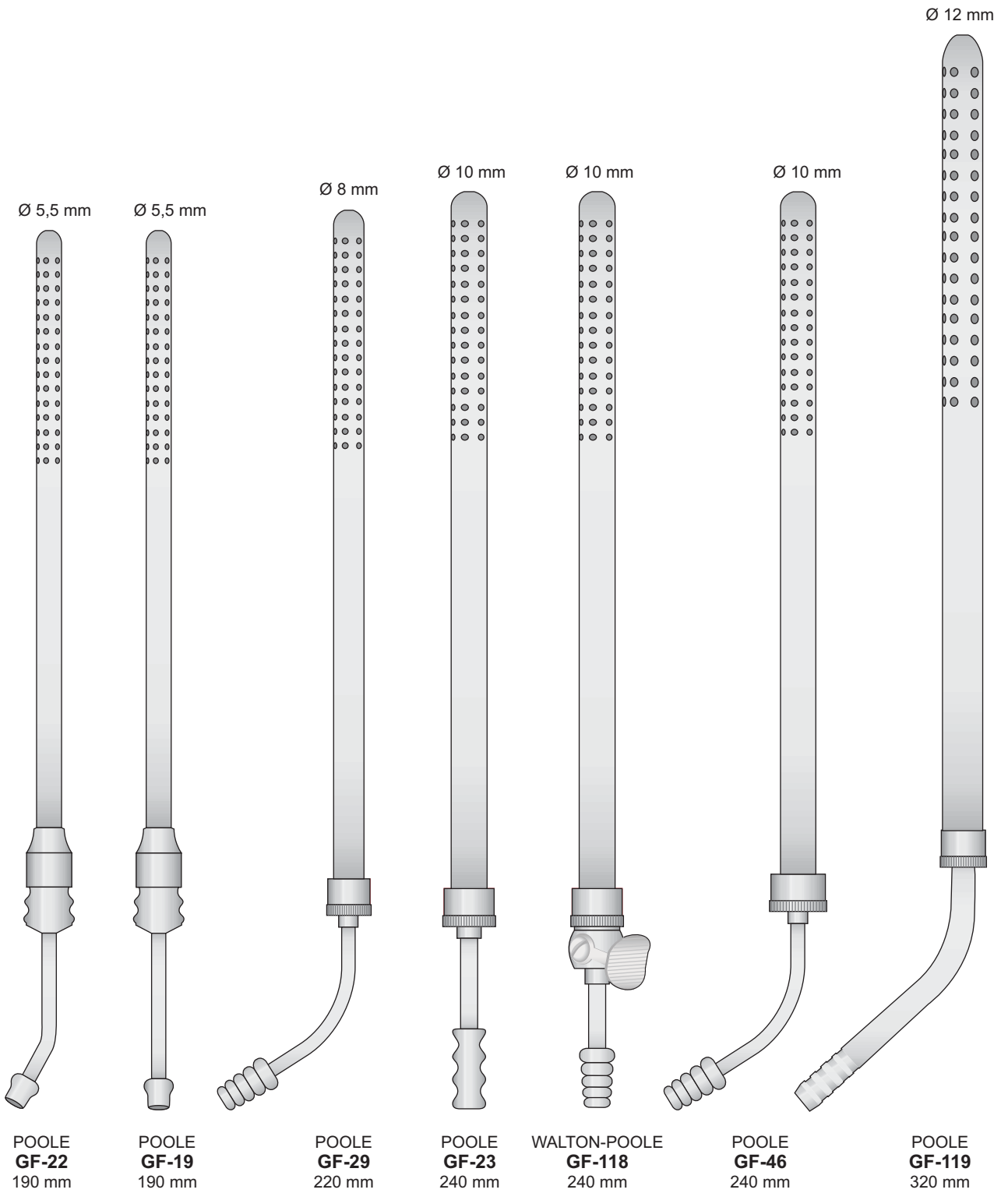

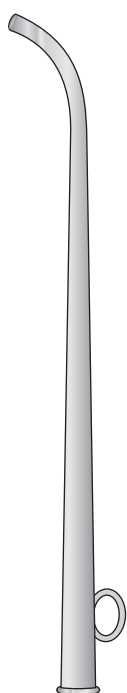

ITARD
GF-156/GF-160
145 mm

- GF-156 Ø 3,0 mm
- GF-157 Ø 3,5 mm
- GF-158 Ø 4,0 mm
- GF-159 Ø 4,5 mm
- GF-160 Ø 5,0 mm

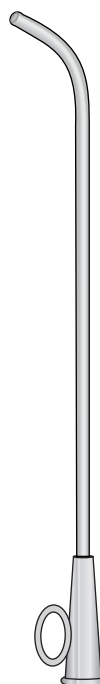

HARTMANN
GF-161/GF-167
150 mm

- GF-161 Ø 2,0 mm
- GF-162 Ø 2,5 mm
- GF-163 Ø 3,0 mm
- GF-164 Ø 3,5 mm
- GF-165 Ø 4,0 mm
- GF-166 Ø 4,5 mm
- GF-167 Ø 5,0 mm



GF-168

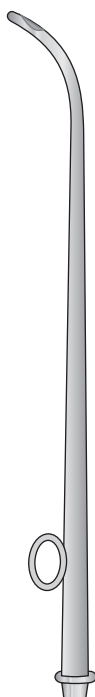

SIEBENMANN
GF-169/GF-173
150 mm

- GF-169 Ø 1,5 mm
- GF-170 Ø 1,7 mm
- GF-171 Ø 2,0 mm
- GF-172 Ø 2,5 mm
- GF-173 Ø 3,0 mm

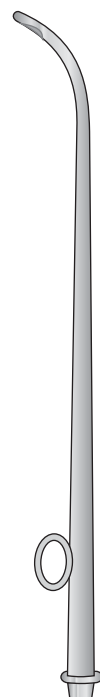

SIEBENMANN
GF-174/GF-178
150 mm

- GF-174 Ø 1,5 mm
- GF-175 Ø 1,7 mm
- GF-176 Ø 2,0 mm
- GF-177 Ø 2,5 mm
- GF-178 Ø 3,0 mm



GF-179

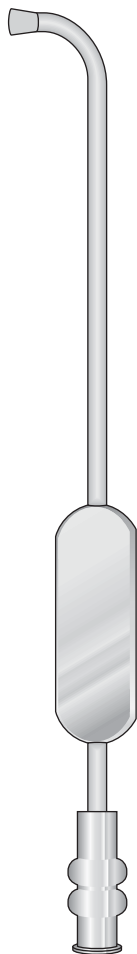

KILLIAN
GF-85 Ø 3 mm
GF-87 Ø 4 mm
145 mm

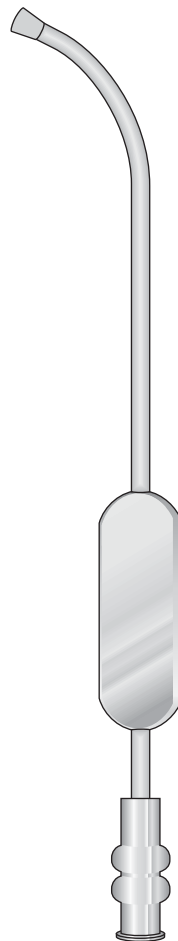

KILLIAN
GF-86 Ø 3 mm
GF-88 Ø 4 mm
145 mm

Ø Interno
Ø Inside
Ø Innen
Ø Intérieur
Ø Interior



MAGILL
GF-100 Ø 1 mm
200 mm

Ø Interno
Ø Inside
Ø Innen
Ø Intérieur
Ø Interior

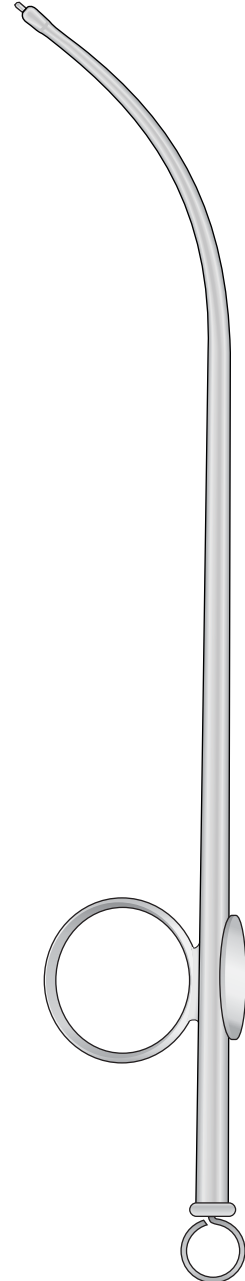

MAGILL
GF-101 Ø 1 mm
GF-102 Ø 2 mm
GF-103 Ø 3 mm
200 mm

Sonde per varici, malleabili - Probe for varicose veins, malleable
 Krampfadersonden, biegsam - Sondes pour varices, malléables
 Sondas para vârices, maleables

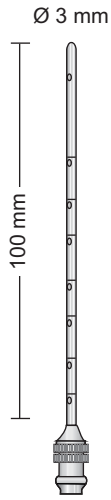

FRAZIER
GF-190

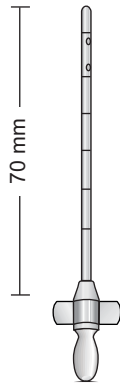

GF-191 - Ø 2 mm
 GF-192 - Ø 2,5 mm

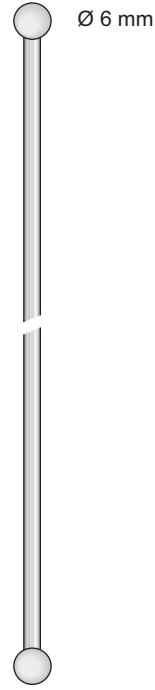

BABCOCK
 OL-66 - 400 mm
 OL-67 - 500 mm
 OL-68 - 650 mm
 OL-69 - 800 mm

Aghi per tonsille
 Tonsil needles
 Tonsillkanülen
 Aiguilles pour les amygdales
 Agujas para amígdalas



OL-01
120 mm

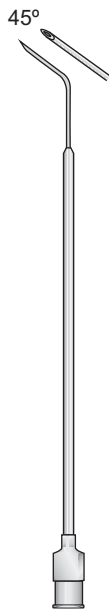

OL-02
110 mm



OL-03
110 mm

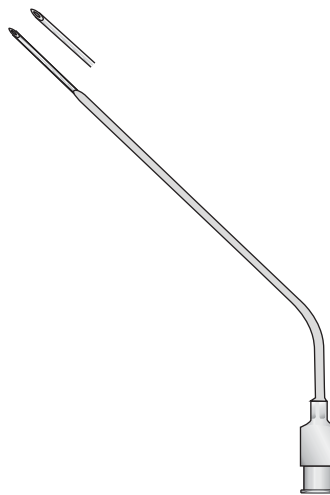

SEPTUN-NADEL
OL-04
110 mm

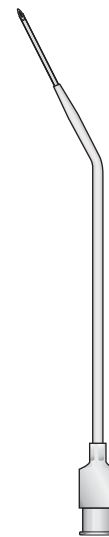

OL-05
110 mm

Ø 1 mm

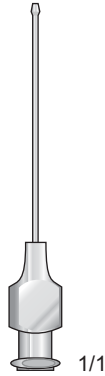

OL-22
50 mm

Ø 2 mm

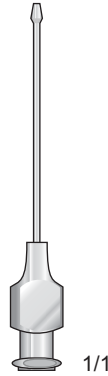

OL-23
50 mm

Ø 3 mm

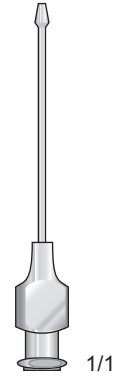

OL-24
50 mm

Canule per irrigazione dei vasi, malleabili
Vessel irrigating cannulas, malleable
Gefäß-spülkanülen, biegsam
Canules d'irrigation pour vaisseaux, malléables
Cànulas de irrigacion para vasos, maleables

Ø 3 mm Ø 4 mm Ø 5 mm Ø 6 mm

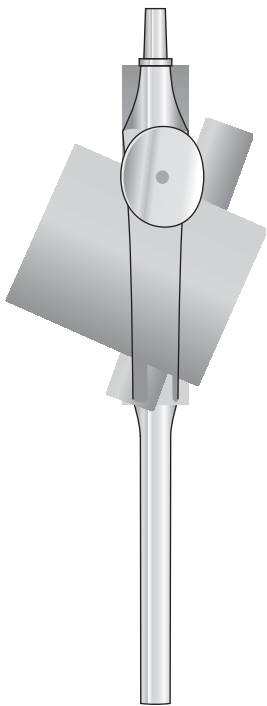

LUER-LOCK
GF-64
120 mm

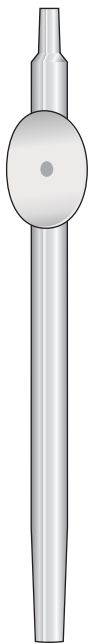

GF-66
110 mm

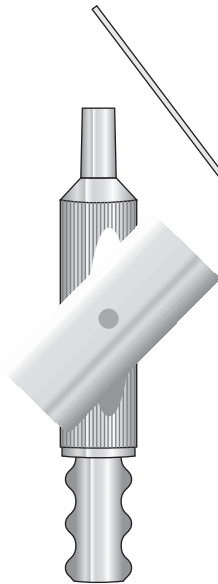

LUER-LOCK
GF-62
65 mm

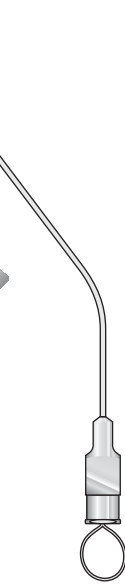

ROSEN
OL-16 Ø 0,70 mm
OL-17 Ø 0,90 mm
OL-18 Ø 1,25 mm
95 mm



ROSEN
OL-13 Ø 0,70 mm
OL-14 Ø 0,90 mm
OL-15 Ø 1,25 mm
95 mm



SCHMID
OL-30
150 mm



SCHMID
OL-31
150 mm



SCHMID
OL-32
150 mm

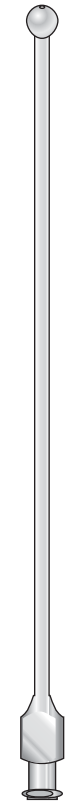

SCHMID
OL-33
150 mm

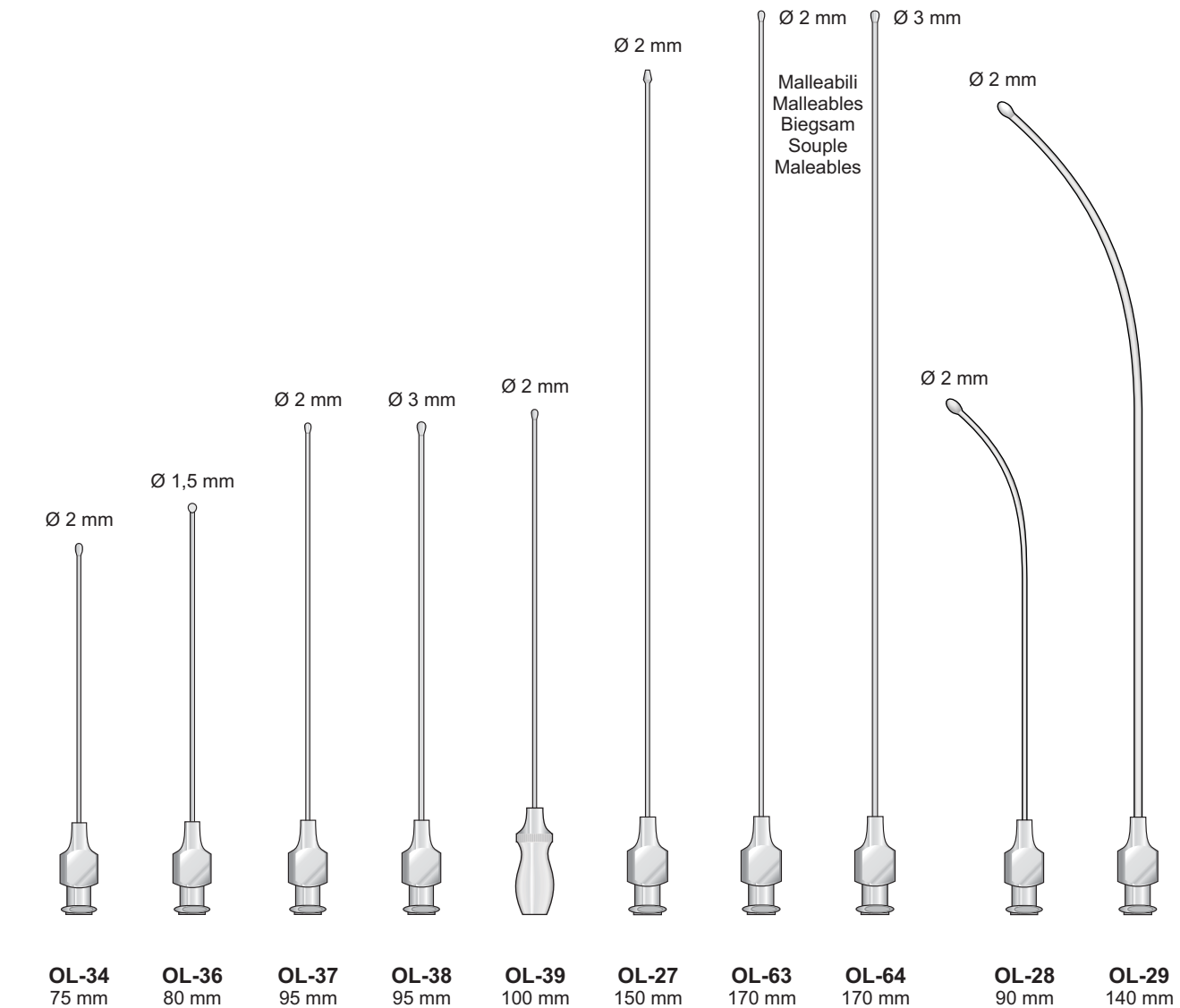
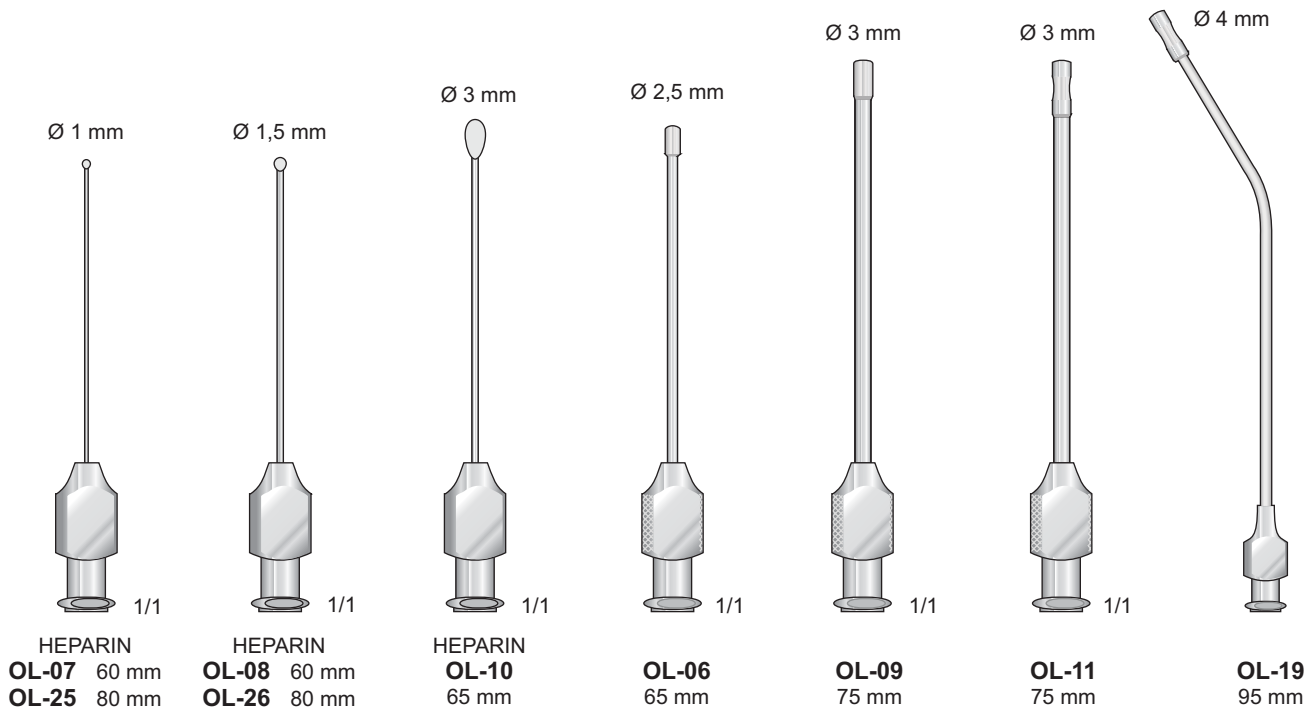

Aghi malleabili

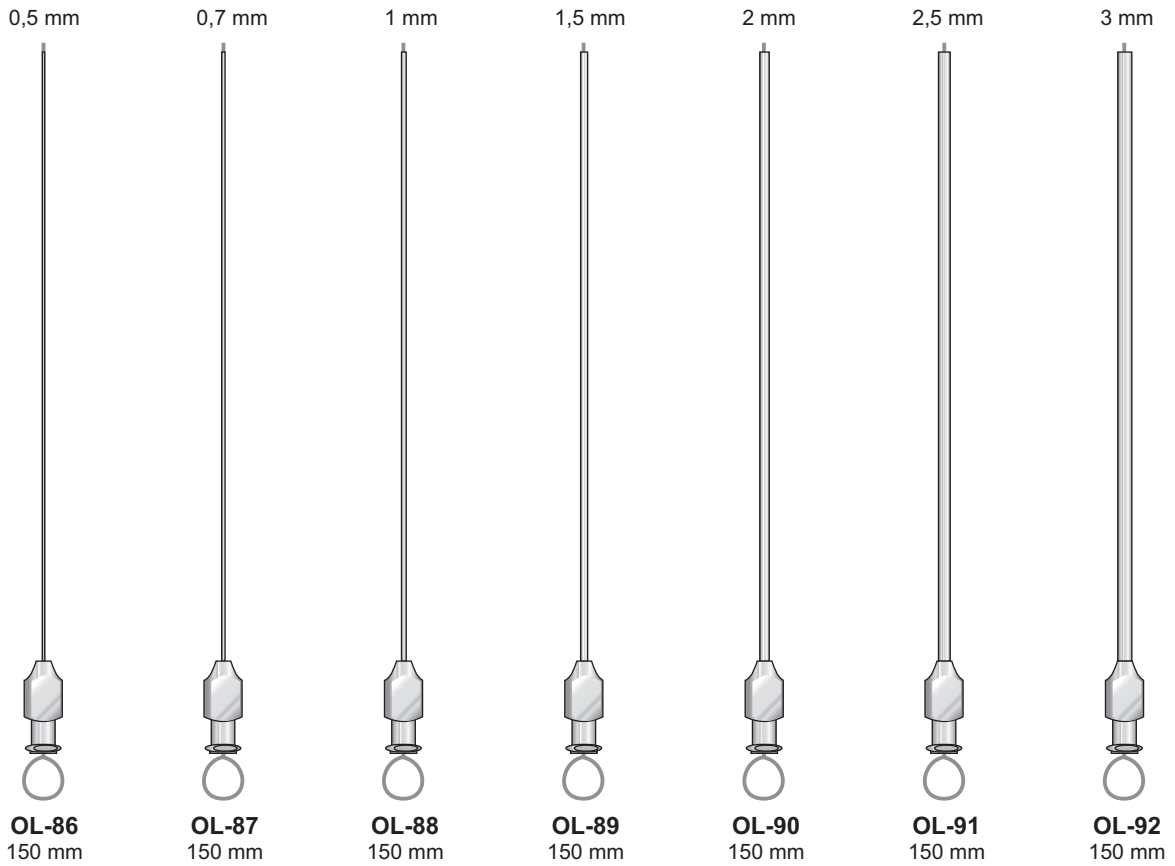

Aghi malleabili con due fori

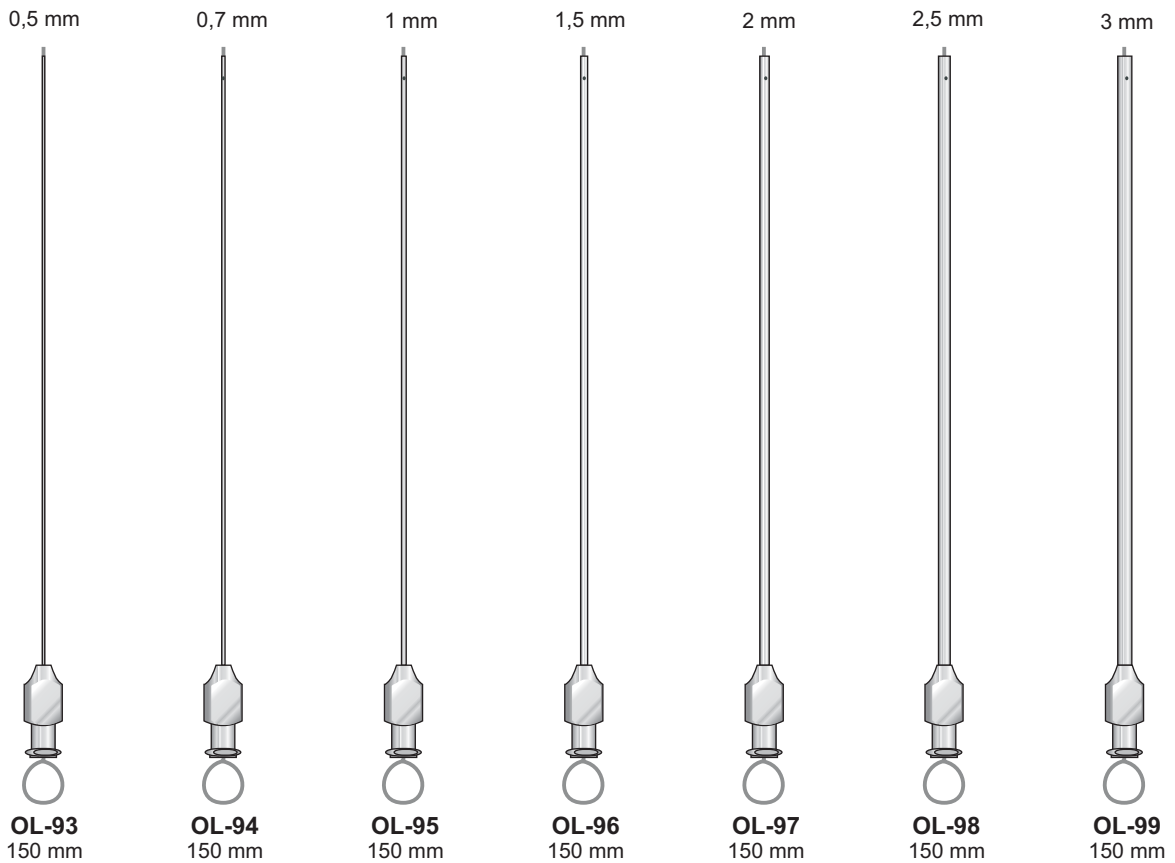

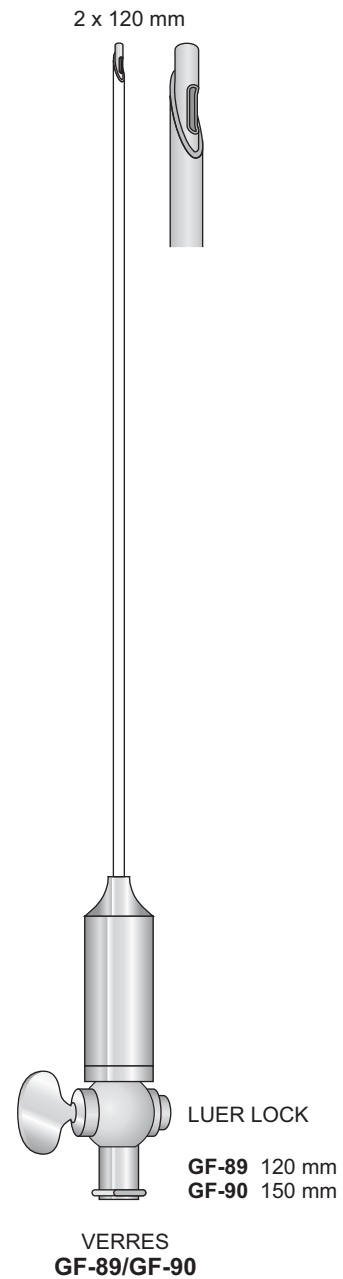
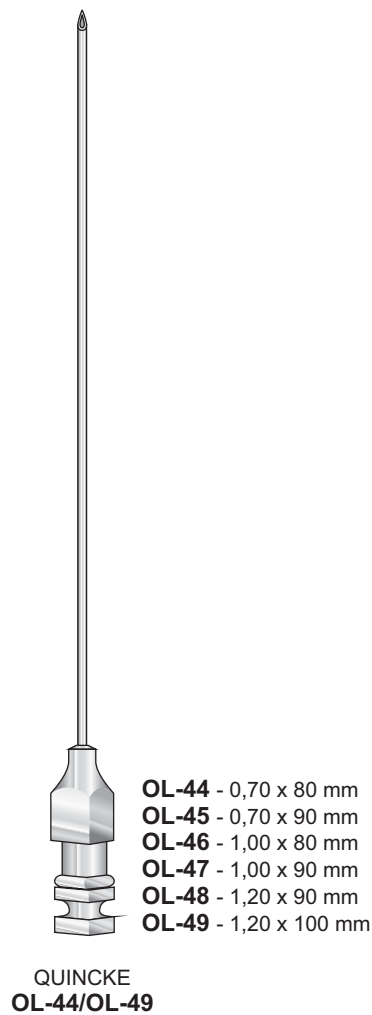
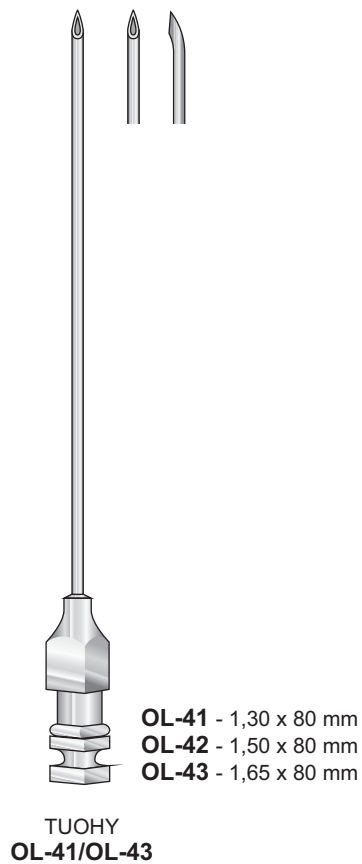

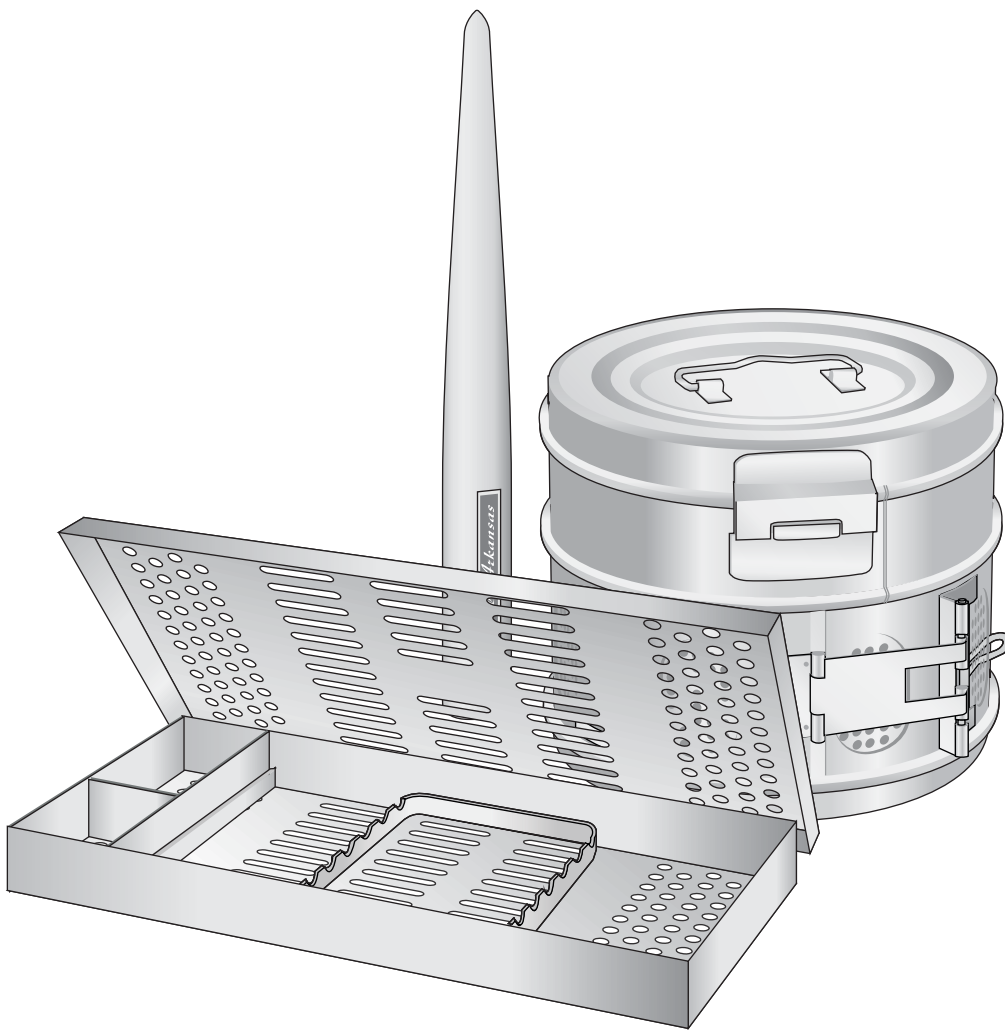

18

Maintenance and Sterilization
Wartung und Sterilisierung
Entretien et Stérilisation
Mantenimiento y Esterilización
Manutenzione e Sterilizzazione

Bacinelle reniformi
Kidney bowls
Nierenschalen
Bassins réniformes
Riñoneras



BR-20 200 mm
BR-25 250 mm
BR-28 280 mm

Vassoi porta-strumenti
Trays
Schalen
Bassins
Bandejas

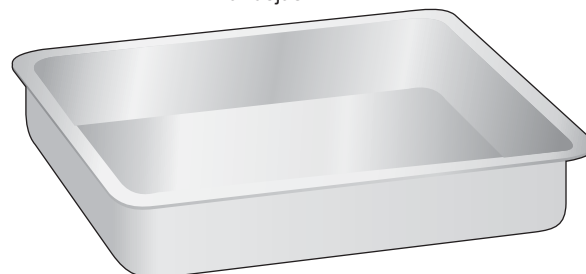

VS-20 210x110x25 mm
VS-26 250x180x30 mm
VS-30 300x220x30 mm

Bacinella in vetro con coperchio e pomolo in acciaio inox
Container in glass with lid and knob in stainless steel
Cuvette en verre avec couvercle et pommeau en acier inox

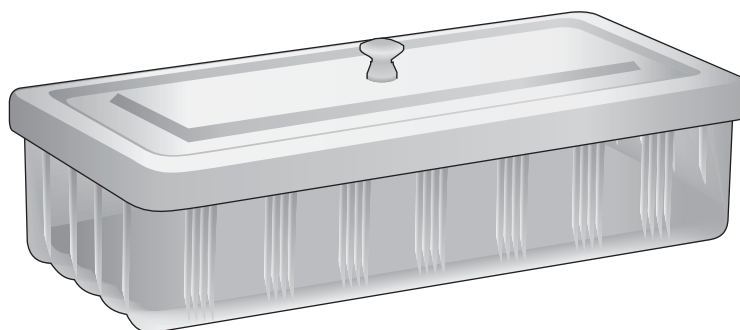

BPS-10 140x80x50 mm
BPS-12 200x60x40 mm
BPS-14 220x100x50 mm
BPS-15 220x140x60 mm
BPS-17 300x180x65 mm

Scatole per sterilizzazione a secco
Instrument boxes
Instrumentenkästen
Boites pour instruments
Cajas para instrumentos

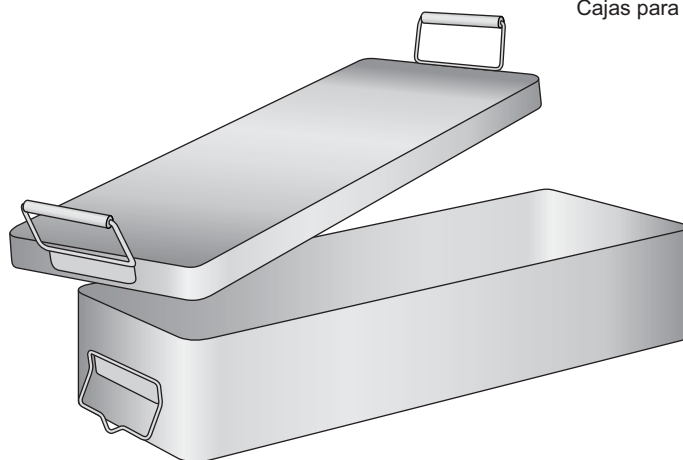

CS-07 280 x 140 x 60 mm
CS-08 300 x 140 x 60 mm
CS-09 360 x 160 x 70 mm

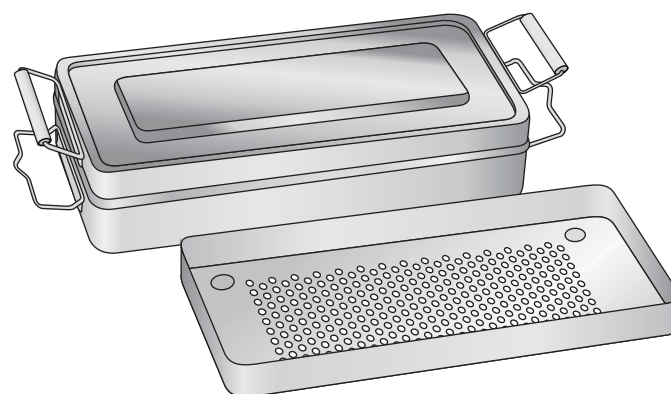

CS-61 150 x 90 x 40 mm
CS-63 200 x 100 x 60 mm
CS-65 250 x 120 x 60 mm
CS-66 280 x 140 x 60 mm
CS-67 320 x 150 x 60 mm

Cestelli rettangolari con filtro
Mit filter
Whith filter
Avec filtre
Con filtros

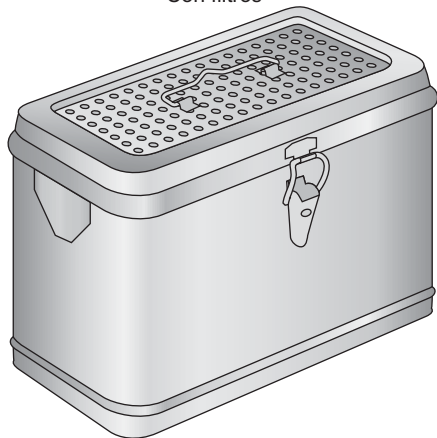

- CS-40** 200 x 180 x 120 mm
- CS-41** 200 x 180 x 180 mm
- CS-42** 250 x 250 x 250 mm
- CS-43** 270 x 160 x 160 mm
- CS-44** 290 x 290 x 290 mm
- CS-45** 350 x 230 x 200 mm

Cestelli cilindrici
Dressing sterilizing drums
Verbandstoffrommeln
Boites à stérilisation
Cajas para esterilización

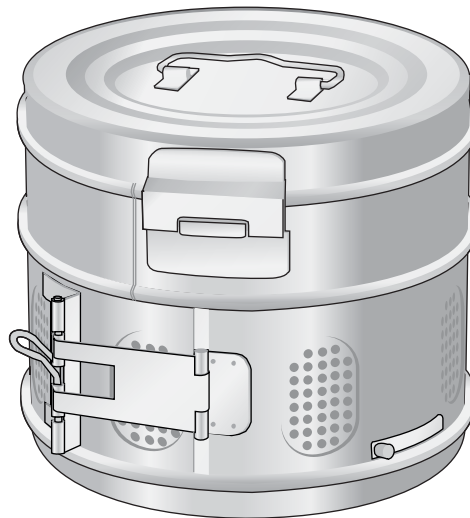

- CS-12** 125x125 mm
- CS-15** 150x150 mm
- CS-19** 190x145 mm
- CS-30** 290x240 mm

Cestelli rettangolari
Rectengular drum
Panier rectangulaire

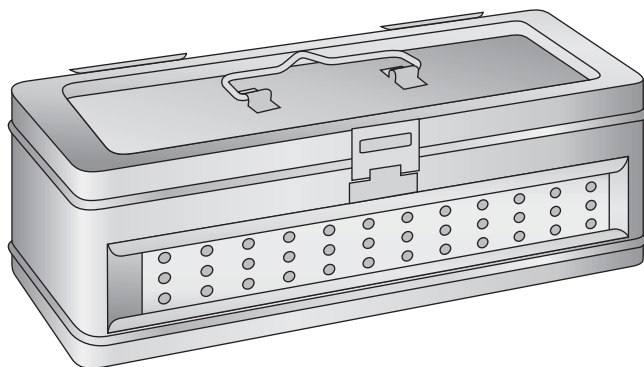

- CS-32** 300 x 150 x 60 mm
- CS-33** 300 x 150 x 90 mm
- CS-34** 300 x 150 x 180 mm

Cestelli rettangolari
Rectengular drum
Panier rectangulaire

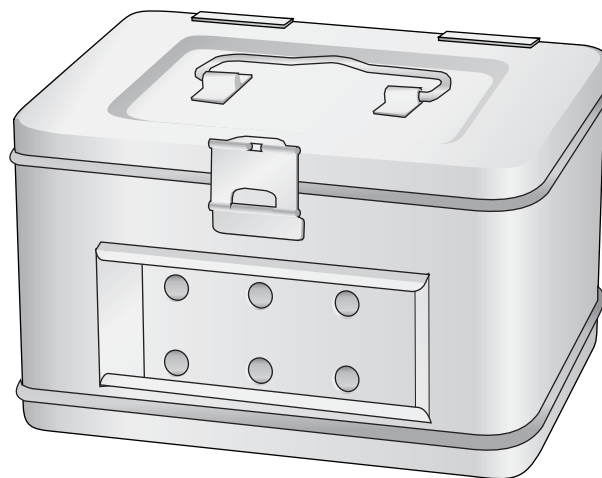

- CS-21** 190x110x120 mm
- CS-20** 200x180x120 mm
- CS-22** 200x180x180 mm
- CS-25** 250x200x200 mm

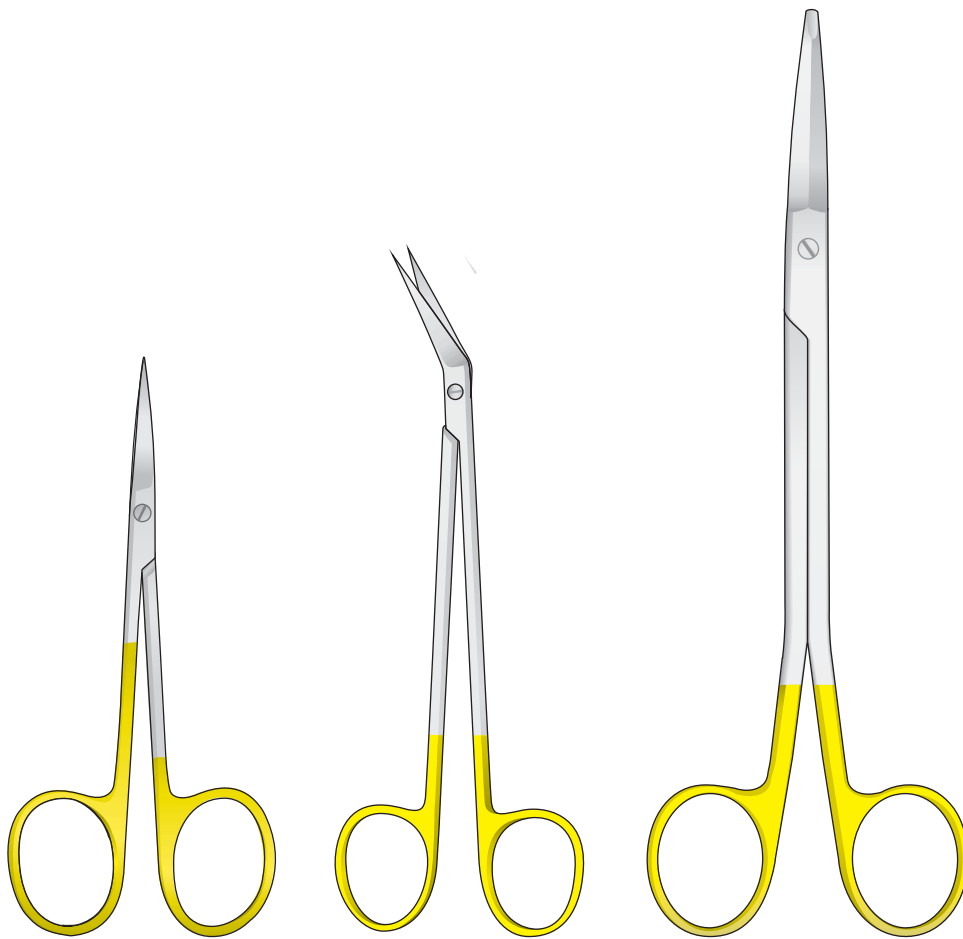

19 |

Addendum
Nachtrag
Ajout
Anexo
Aggiunta

Diagnostik-Bestecke - Diagnostic Sets
 Set Diagnostica - Set Diagnóstico
 Trousses à Diagnostic

Etui für McINTOSH Fig. 1-3
 Case for McINTOSH Fig. 1-3
 Casseta per laringoscopio McINTOSH Fig. 1-3
 Estuche para McINTOSH Fig. 1-3
 Etui pour McINTOSH Fig. 1-3

Halogen - Alogeno



AB-49

Otoscopio completo con custodia

AA-E103



SPENCER
SC-14
 120 mm

LITTAUER
SC-15
 140 mm



Tungsten-Carbide Inserts
 Mit Hartmetalleinsätzen
 Plaquettes en carbure de tungstène
 Plaquetas de carburo de tungsteno
 Inserti in carburo di tungsteno

SUPER CUT



Super Cut Scissors have specially designed cutting edges.
 One regular edge and **one sharp-knife edge**.



Extremely Sharp Razor Edge / Atraumatic
 Extrem Scharfe Spitzer Beck / Atraumatische
 Tranchant extrêmement aiguisée / Atraumatic
 Borde extremadamente afilado / Atraumatica
 Taglio estremamente affilato / Atraumatica



One side serrated
 Eine seite gezahnt
 Un côté dentelé
 Un lato dentellato

Wellenschliff
 TC

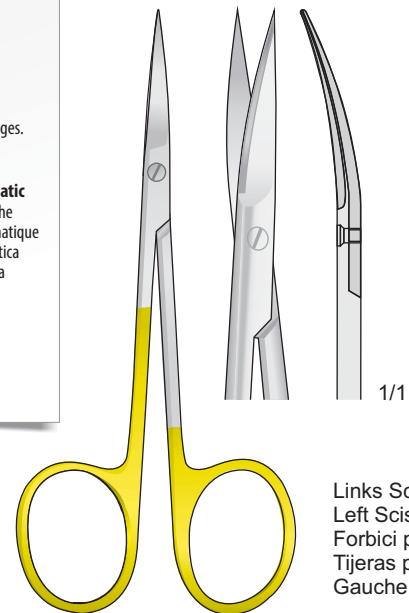

IRIS
FM-100L
 110 mm

Links Scheren
 Left Scissors
 Forbici per mancini
 Tijeras para zurdos
 Gauche Ciseaux

“Ribbon type”

Mit großen Ringen
 With large rings
 Forbici ad anelli grandi
 Con anillos especialmente grandes
 avec larges anneaux

Iris scissors

Blepharoplasty
 Blefaroplastica

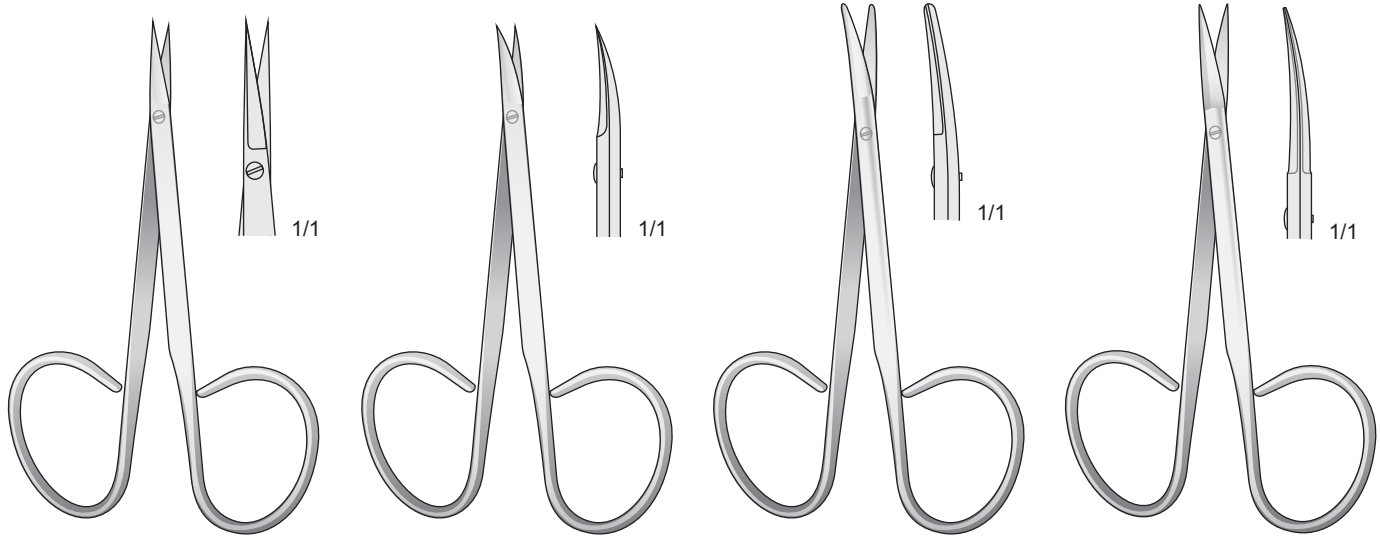

FG-200
95 mm

FG-201
95 mm

FG-202
95 mm

FG-203
105 mm

Iris scissors

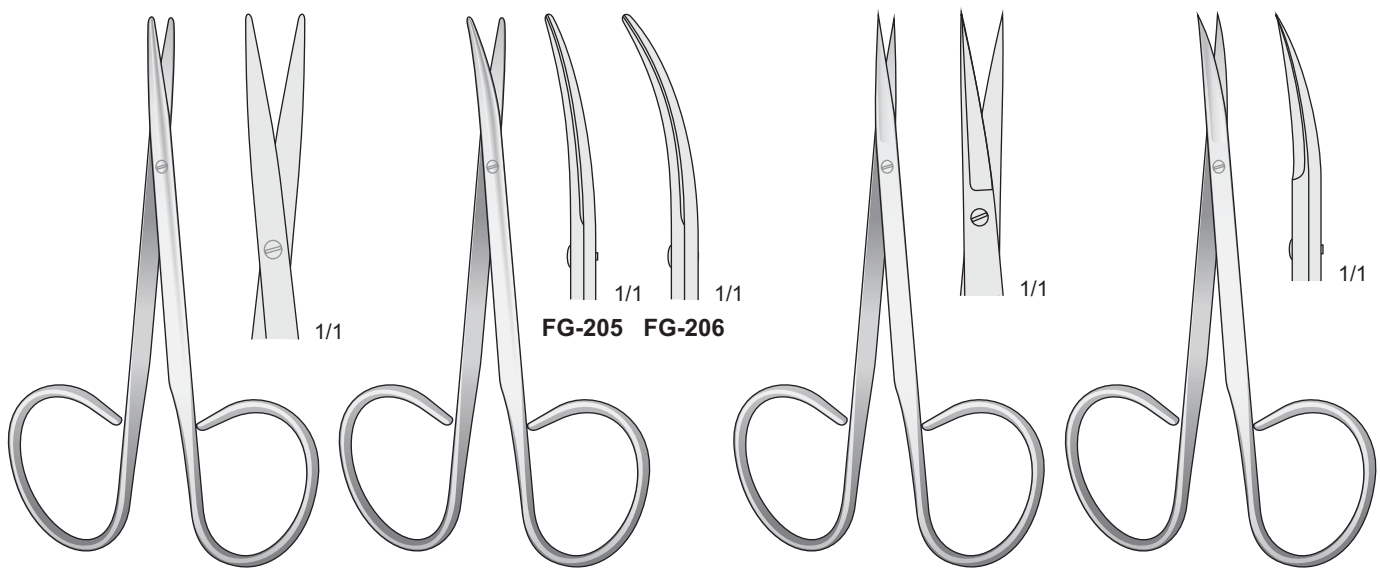

FG-204
100 mm

FG-205/FG-206
100 mm

FG-207
105 mm

FG-208
105 mm

“Ribbon type”

Mit großen Ringen
With large rings
Forbici ad anelli grandi
Con anillos especialmente grandes
avec larges anneaux

Spitz
Sharp
Acuta
Aguda
Pointu

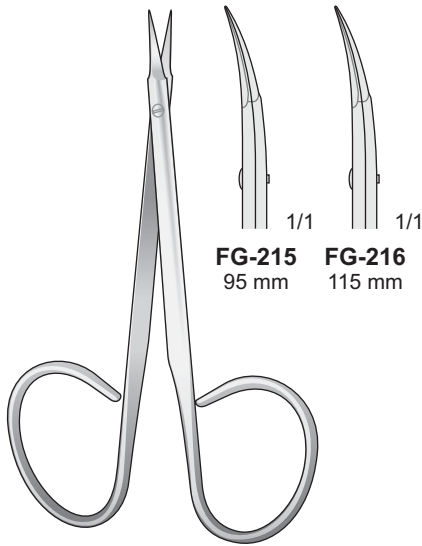

STITCH
FG-215/FG-216

Stumpf
Blunt
Smussa
Romas
Mousse

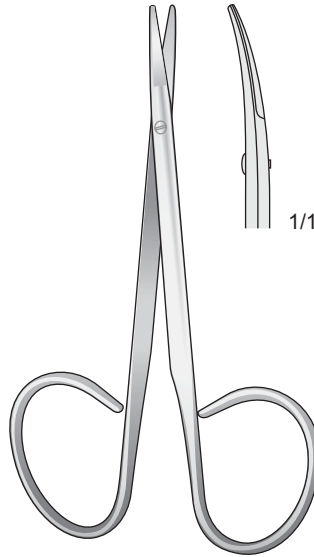

FG-217
100 mm

Gezahnt
Serrated
Dentellata
Dentadas
Dentelés

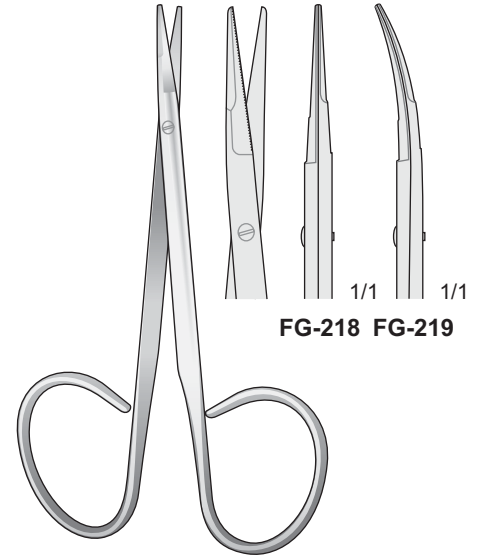

KAYE
FG-218/FG-219
105 mm

Stumpf - Blunt
Smussa - Romas
Mousse

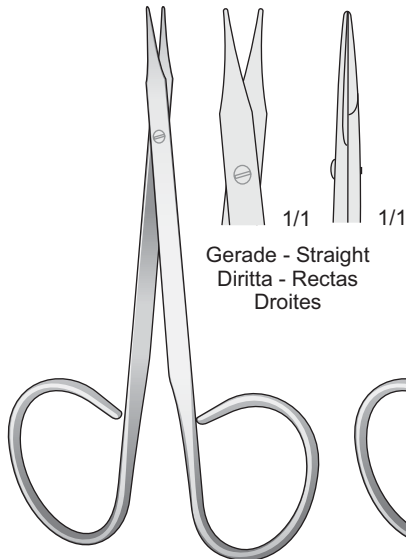

STEVENS
FG-209
100 mm

Stumpf - Blunt
Smussa - Romas
Mousse

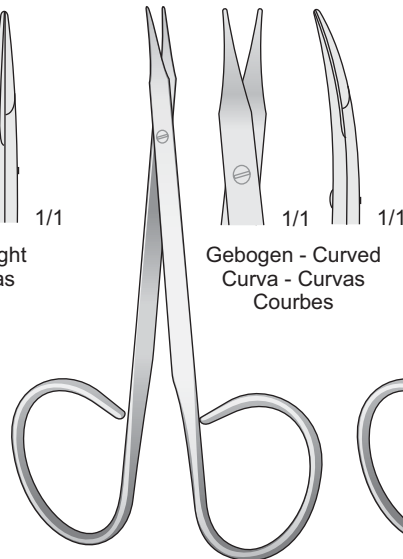

STEVENS
FG-210
100 mm

Spitz - Sharp
Acuta - Aguda
Pointu

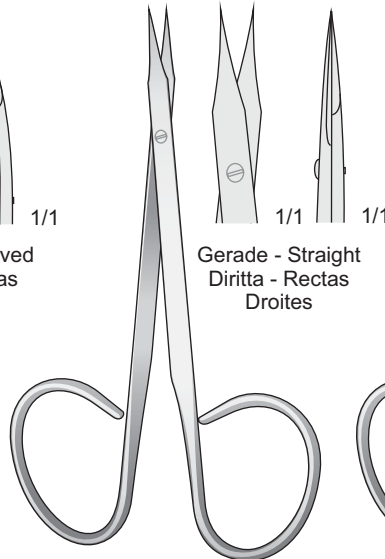

WALTON
FG-211
100 mm

Spitz - Sharp
Acuta - Aguda
Pointu

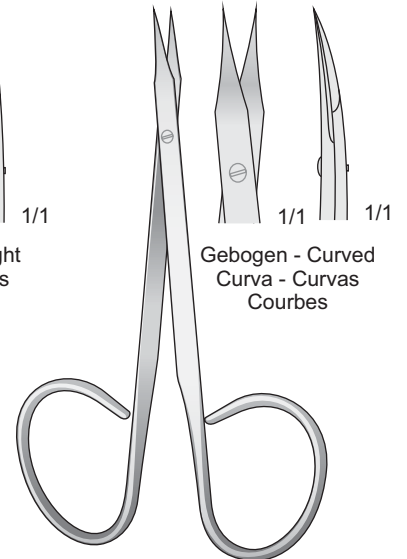

WALTON
FG-212
100 mm

19

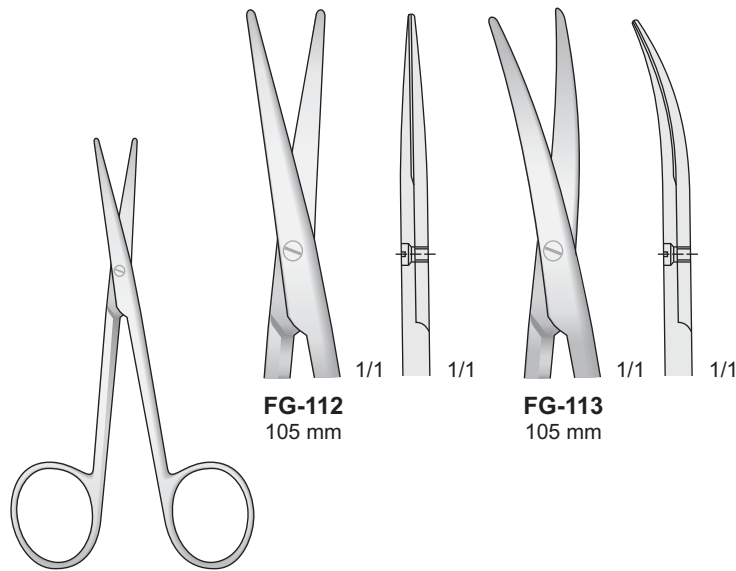

FG-112
105 mm

FG-113
105 mm

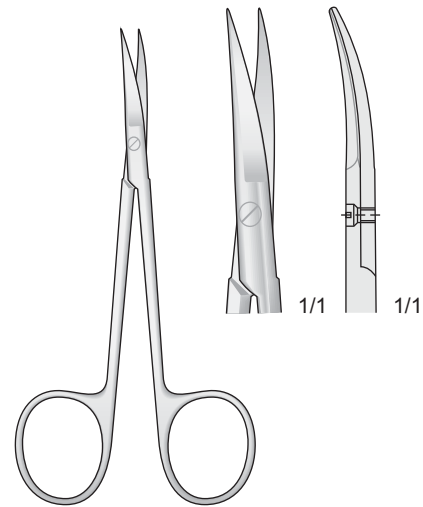

COTTLE
FG-59
115 mm

COTTLE-KNAPP
FG-112/FG-113
105 mm

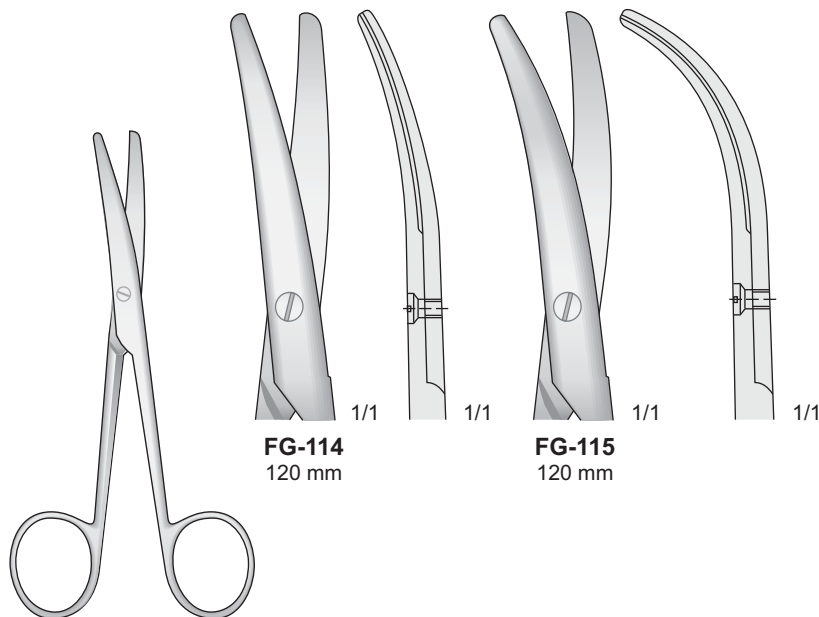

FG-114
120 mm

FG-115
120 mm

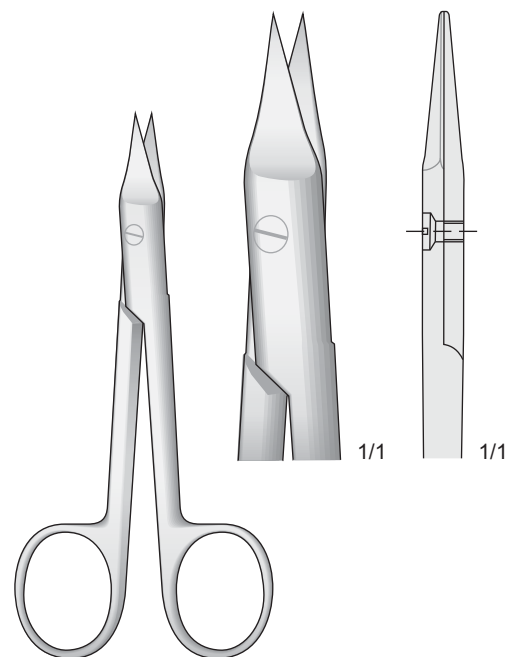

SYSTRUNK
FG-118
130 mm

LANDOLT
FG-114/FG-115
120 mm

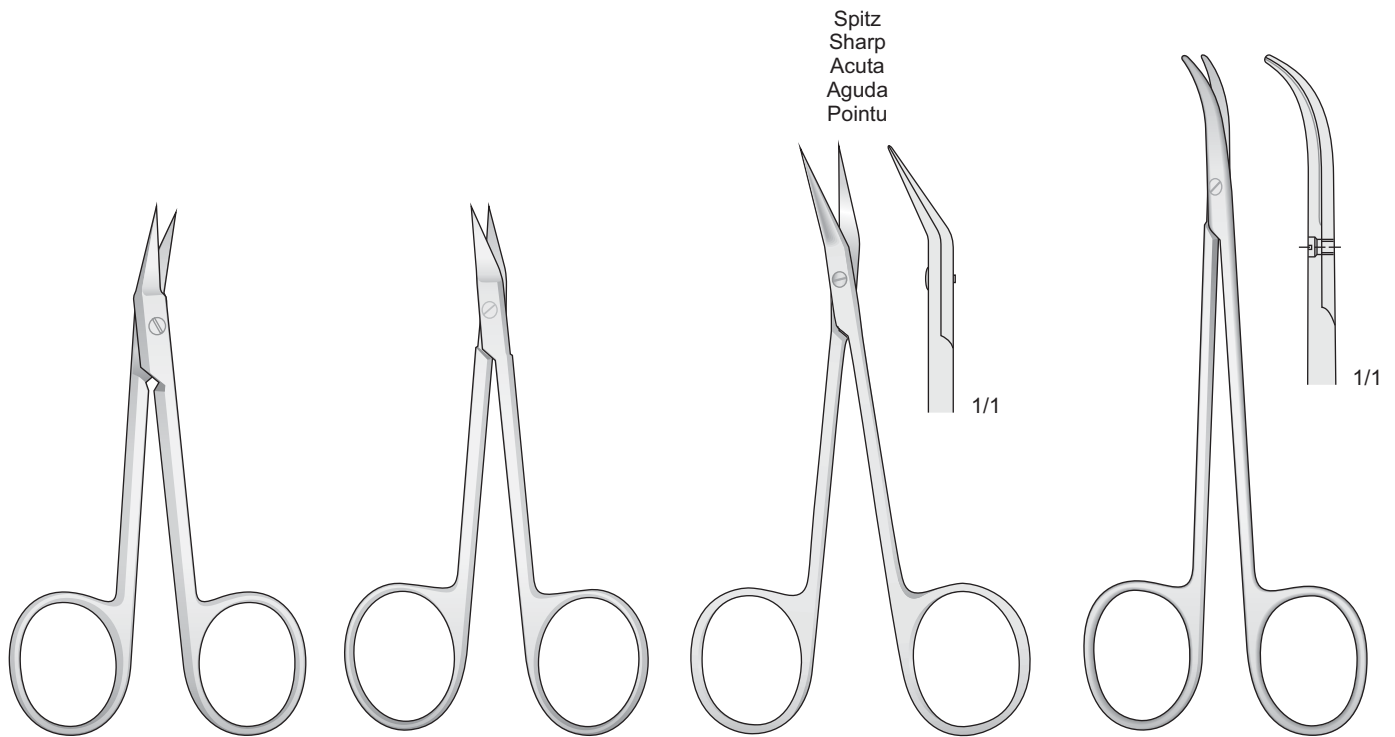

O'BRIEN
FG-151
95 mm

DANIELS
FG-29
90 mm

BIRO
FG-94
100 mm

CINELLI
FG-95
115 mm

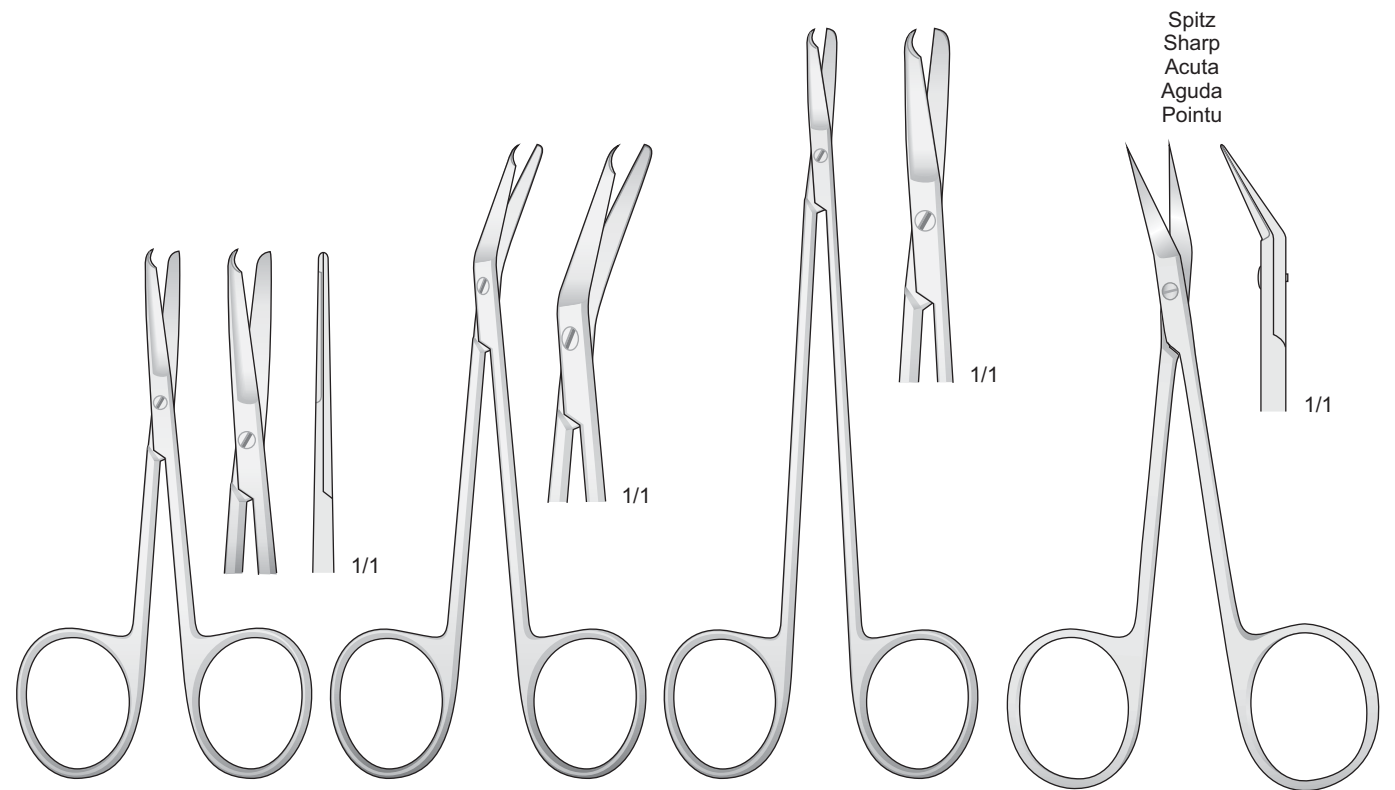

SPENCER
SC-9
90 mm

SPENCER
SC-13
130 mm

KELLY
SC-16
150 mm

WILMER
FG-122
105 mm

19



FG-45
190 mm

FG-46
230 mm

FG-65
250 mm

THOREK
FG-45/FG-65

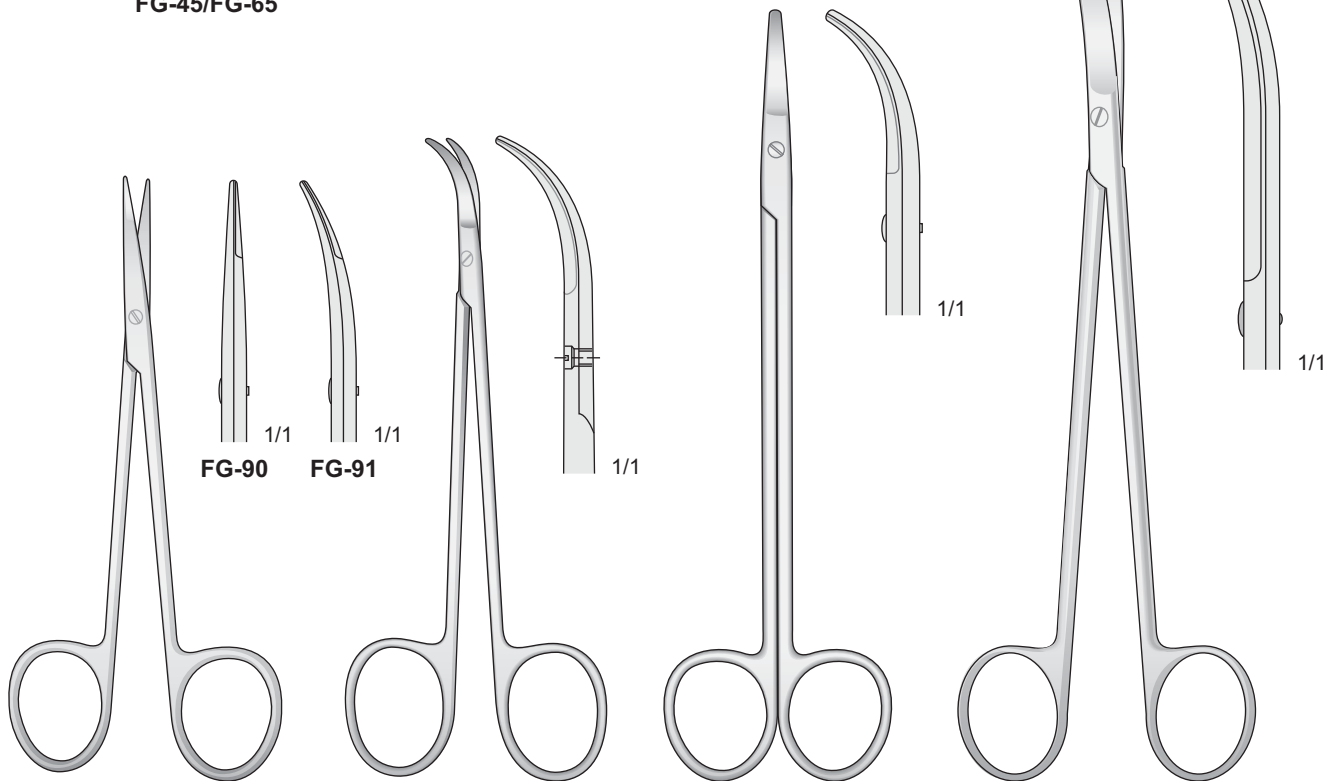

FG-90

FG-91

1/1

1/1

1/1

SHEA
FG-90/FG-91
120 mm

FOMON
FG-93
135 mm

WALTON
FG-146
165 mm

JORGENSEN
FG-143
230 mm

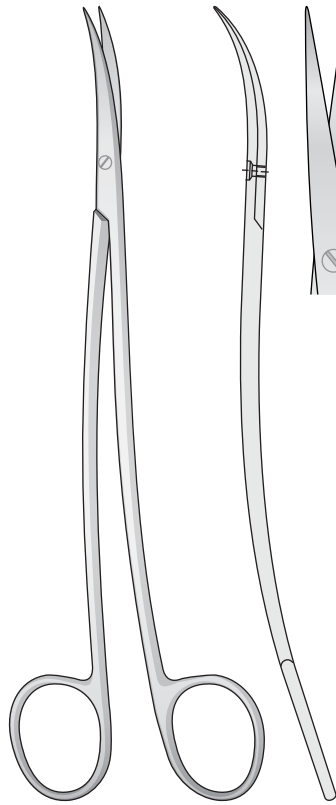

METZENBAUM-FINO
FM-123 - 180 mm
FM-124 - 200 mm
FM-125 - 230 mm

Gezant - Sawedge
Dentellate - Dentadas
Dentelés

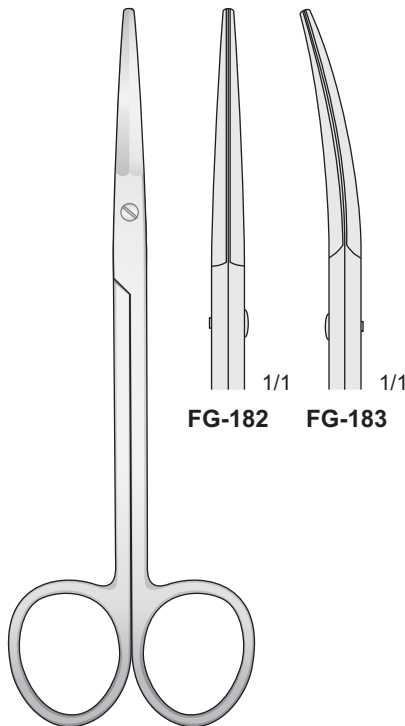

KAHN
FG-182/FG-183
145 mm

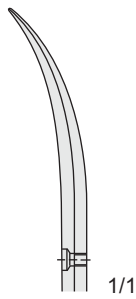

LEXER-BABY
FM-176
100 mm

TC

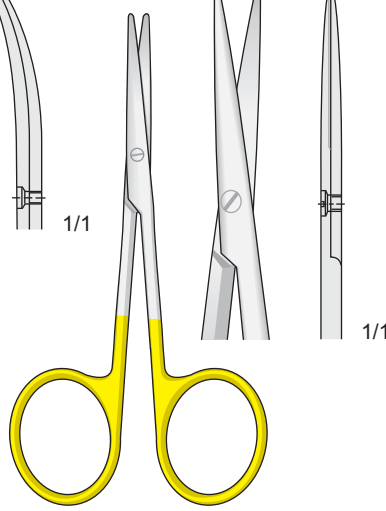

TC
TUNGSTEN
CARBIDE
Tungsten-Carbide Inserts
Mit Hartmetalleinsätzen
Plaquettes en carbure de tungstène
Plaquetas de carburo de tungsteno
Inserti in carburo di tungsteno

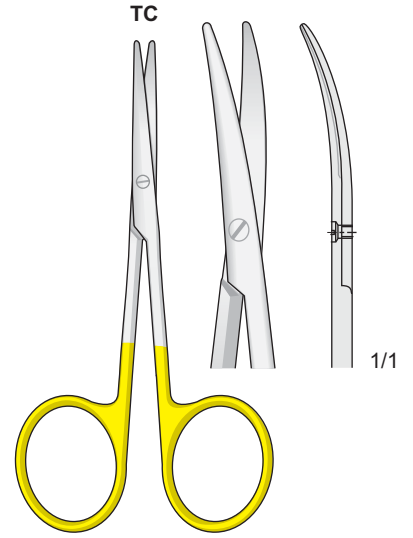

LEXER-BABY
FM-177
100 mm

Gezant - Sawedge
Dentellate - Dentadas
Dentelés

Gezant - Sawedge
Dentellate - Dentadas
Dentelés

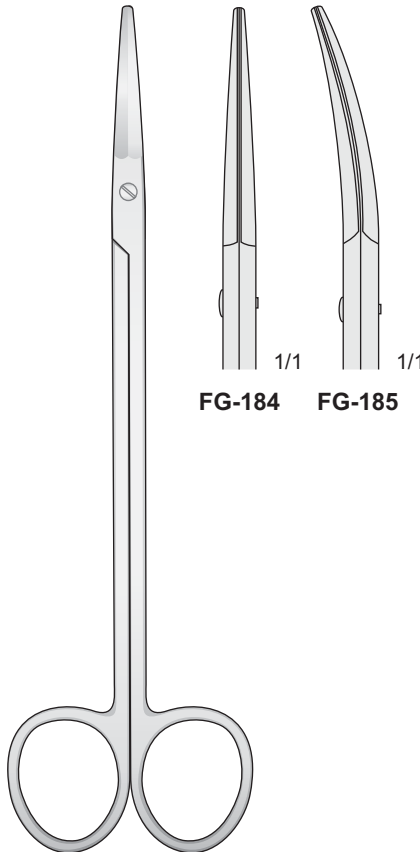

KAHN
FG-184/FG-185
180 mm



KAHN
FG-186/FG-187
205 mm

19



Eine Schneide gezahnt S-förmig gebogen
 One toothed cutting edge S-shaped
 Una lama dentata curva a forma S
 Una hoja dentada forma S
 Une lame dentelée courbés en S

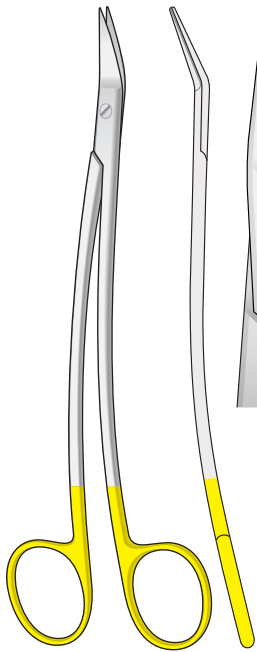

DEAN TC

MAYO
FM-64/FM-65
155 mm

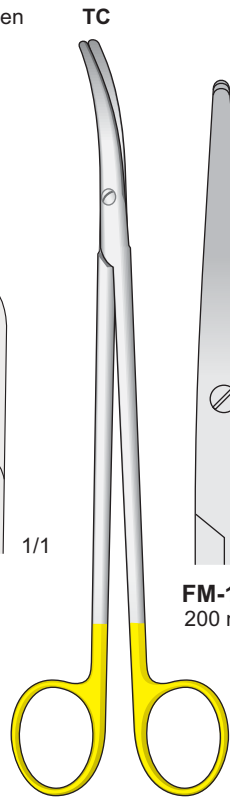

METZENBAUM-THOREK
FM-171/FM-173

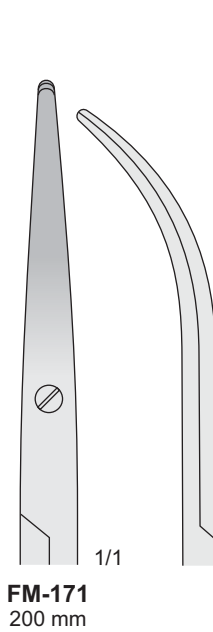

FM-64

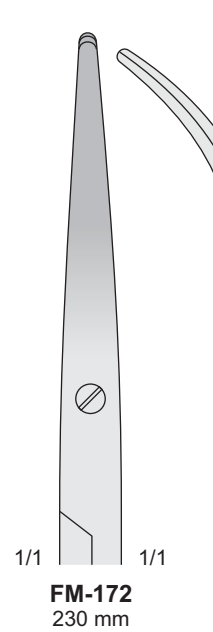

FM-65

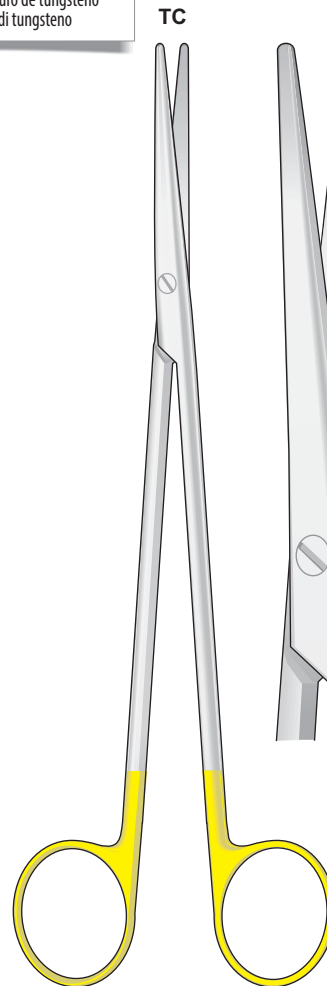
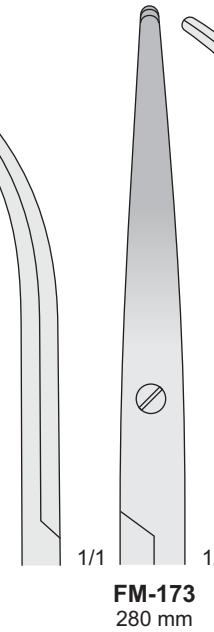

METZENBAUM
FM-166
280 mm

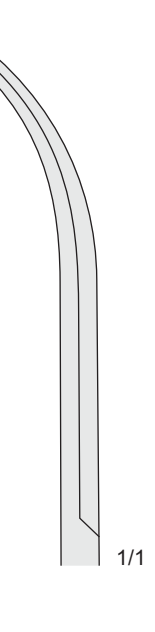

FM-166

TC
TUNGSTEN CARBIDE

Tungsten-Carbide Inserts
 Mit Hartmetalleinsätzen
 Plaquettes en carbure de tungstène
 Plaquetas de carburo de tungsteno
 Inserti in carburo di tungsteno



Gezahnt
Sawedge
Dentellate
Dentadas
Dentelés

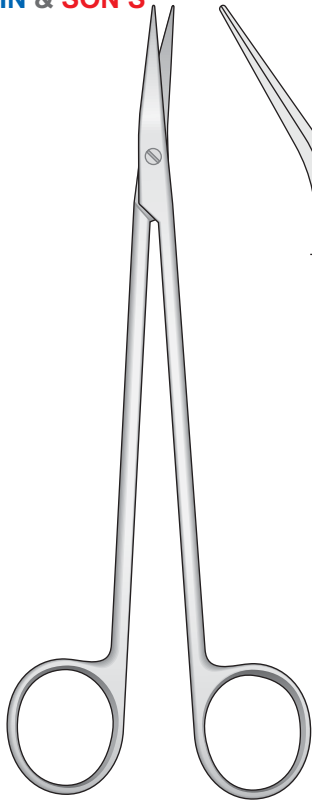

POTTS-SMITH
FG-155
175 mm

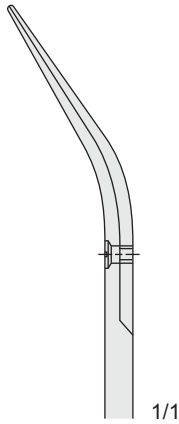

1/1

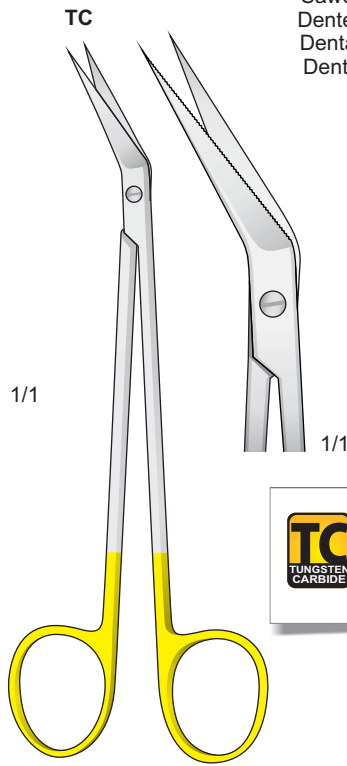

LK-10
160 mm



1/1

TC
Tungsten-Carbide Inserts
Mit Hartmetalleinsätzen
Plaquettes en carbure de tungstène
Plaquetas de carburo de tungsteno
Inserti in carburo di tungsteno

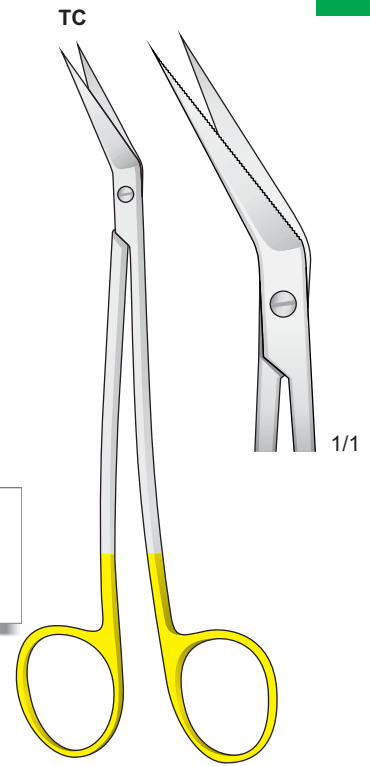

LK-12
160 mm

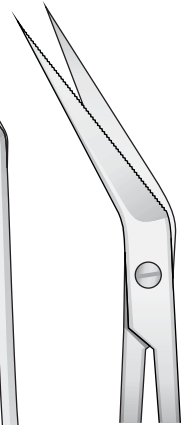

1/1

Gefäßscheren
Vessel scissors

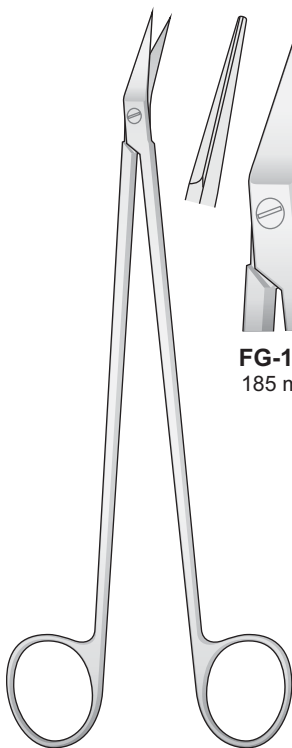

POTTS-DE MARTEL
FG-170/172
185 mm

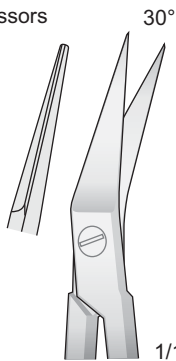

1/1

FG-170
185 mm

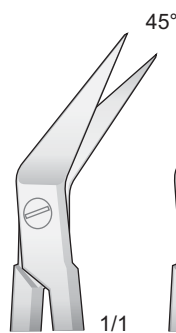

1/1

FG-171
185 mm

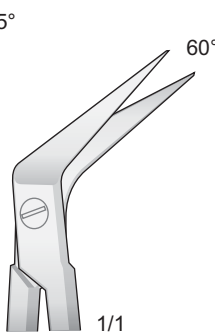

1/1

FG-172
185 mm

Coronararterien-Schere
Coronary artery scissors

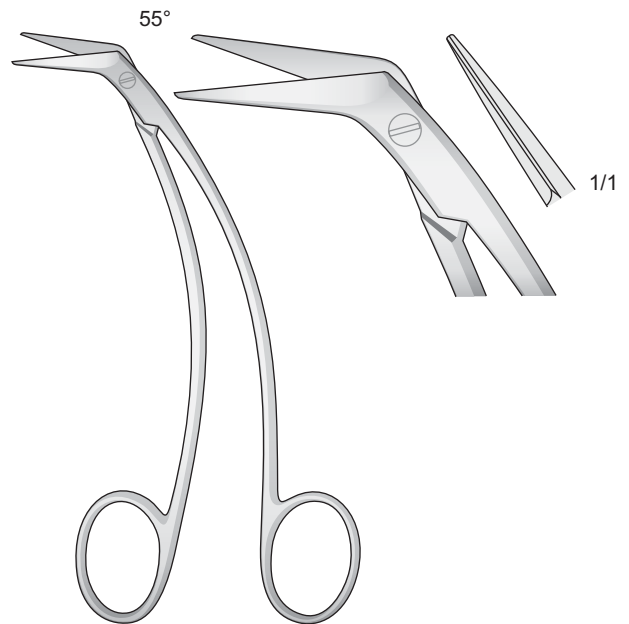

FAVOLORO
FG-164
140 mm

55°

1/1

19

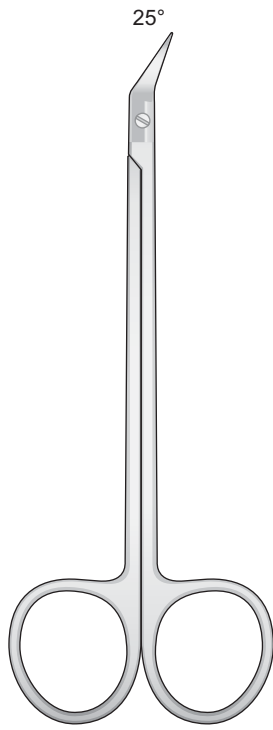

FG-173
135 mm

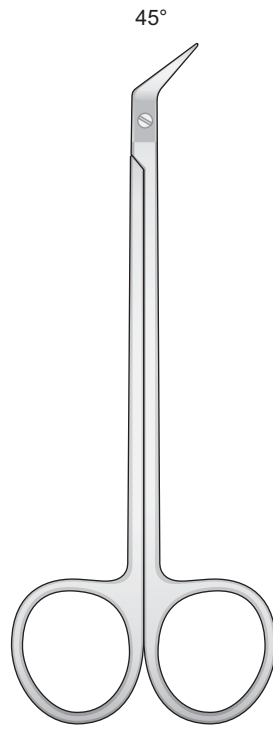

FG-174
135 mm

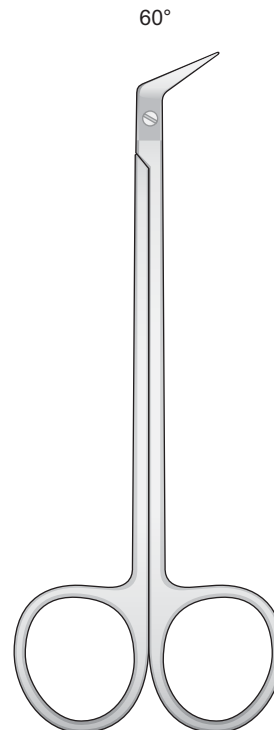

FG-175
135 mm

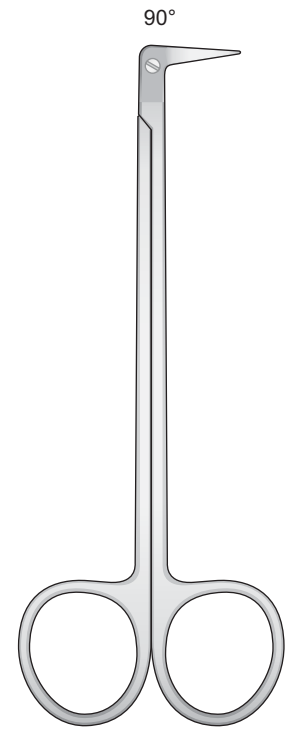

FG-176
135 mm

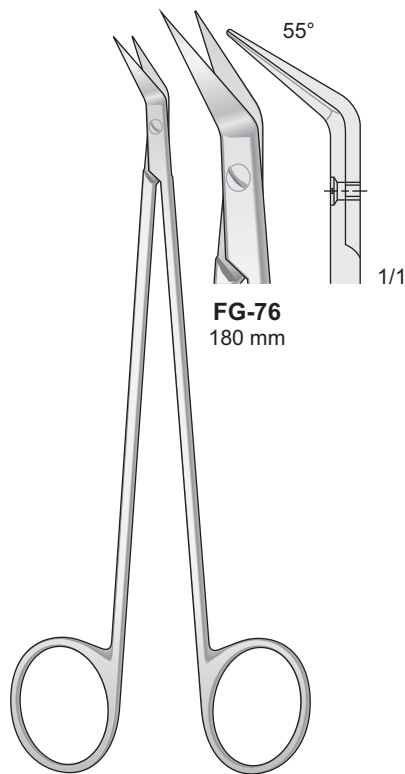

POTTS-SMITH
FG-76
180 mm

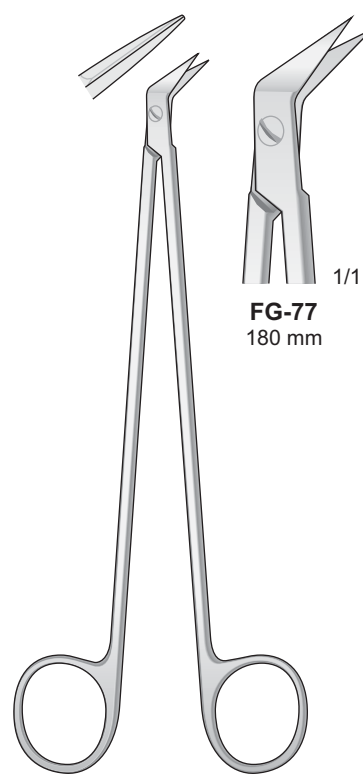

POTTS-SMITH
FG-77
180 mm

Gezahnt - Serrated
Dentellata - Dentadas
Dentelés

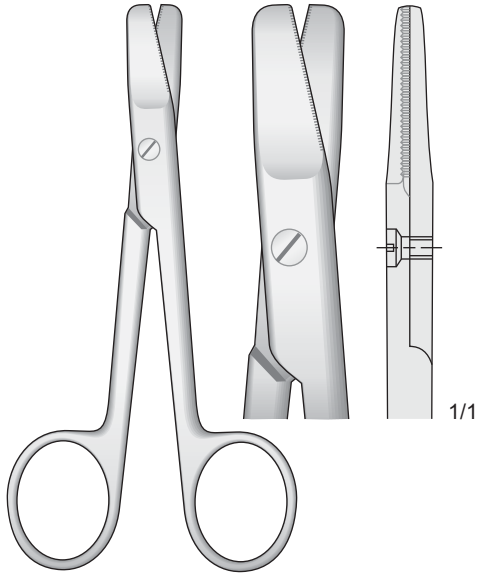

HARVEY
FG-162
125 mm

Spitz - Sharp
Acuta - Agudo - Aigu



METZENBAUM
FM-126/FM-127
145 mm

Kapselschere
Forbice da cartilagine
Cartilage Scissors

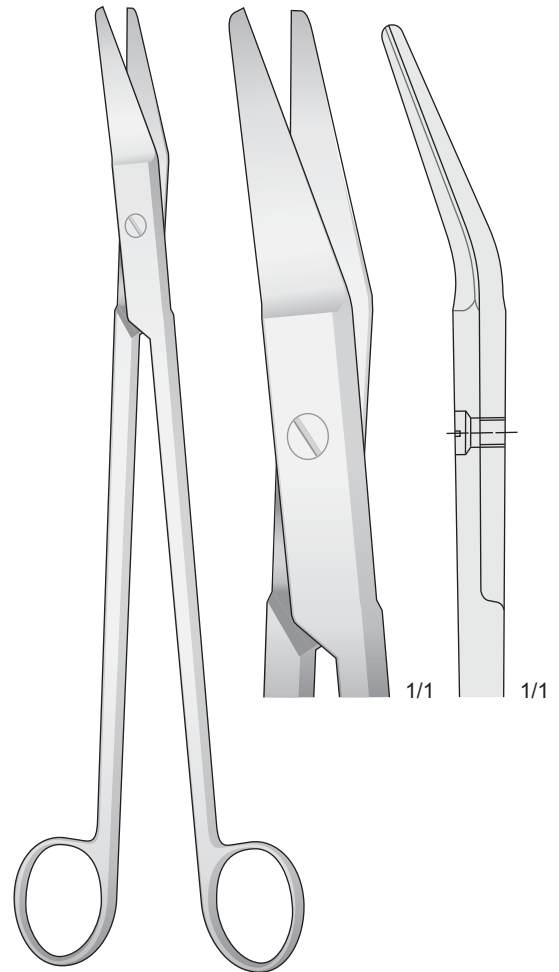

RESANO
FG-130
250 mm

Uterusschere
Uterine scissors

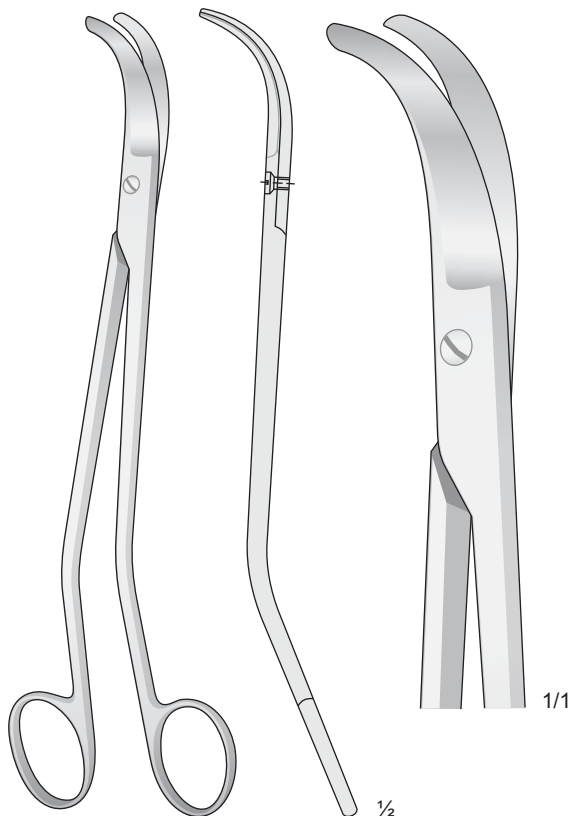

BOZEMANN
FG-145
220 mm

19



Gezahnt - Serrated
Dentellata - Dentadas - Dentées

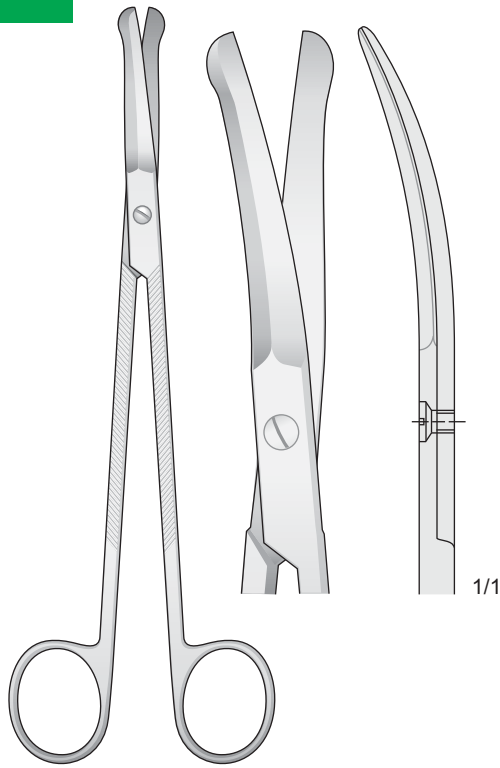

**GOOD
FG-135**
195 mm

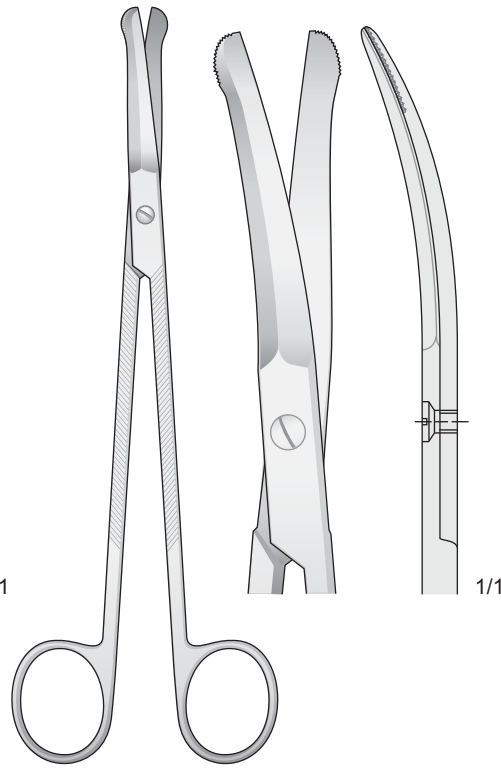

**SCHWECKENDIEK
FG-136**
195 mm

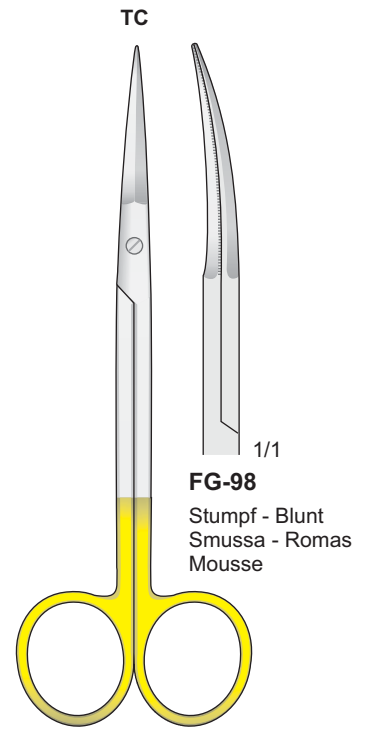

**PECK-JOSEPH
FG-98**
140 mm

FG-98
Stumpf - Blunt
Smussa - Romas
Mousse

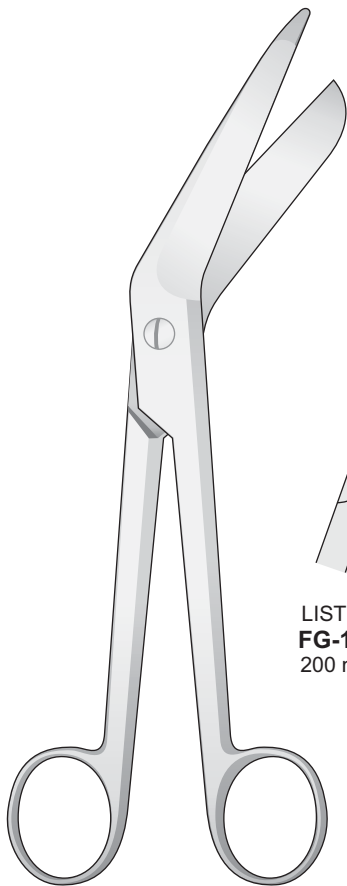

FG-134/FG-137

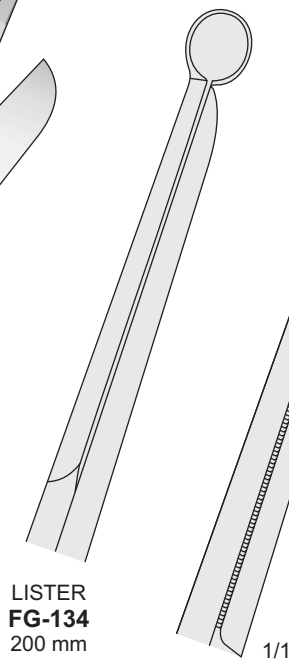

**BERGMANN
FG-137**
230 mm

**LISTER
FG-134**
200 mm

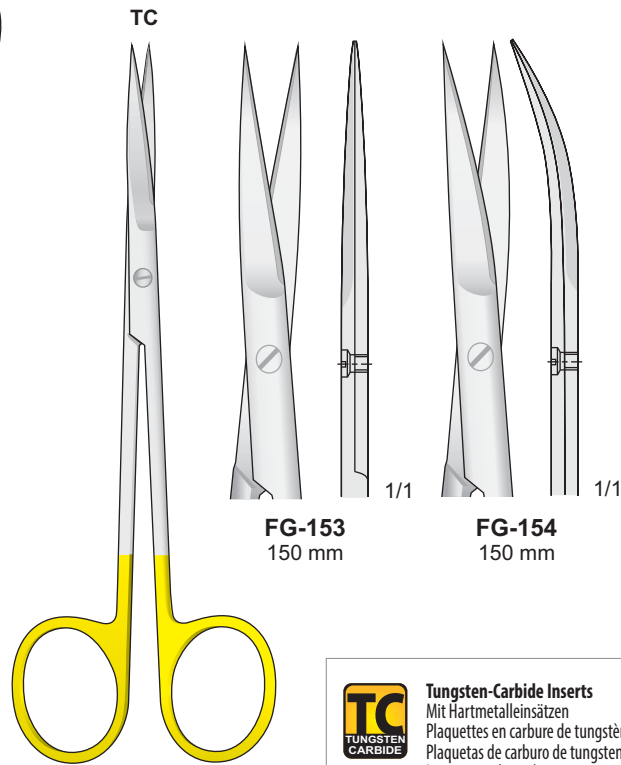

**JOSEPH
FG-153/FG-154**
150 mm

FG-153
150 mm

FG-154
150 mm

TC
TUNGSTEN
CARBIDE

Tungsten-Carbide Inserts
Mit Hartmetalleinsätzen
Plaquettes en carbure de tungstène
Plaquetas de carburo de tungsteno
Inserti in carburo di tungsteno

“Super-cut” scheren micro-schliff für tissue atrauma
 “Super-cut” scissors for gripping tissue and cutting interproximally
 Forbici “super-cut” estremamente taglienti per tessuti con riduzione del trauma
 Tijeras “super cortes” para cortar tissue-atrauma
 Ciseaux “super cut” coupe les tissus en réduisant les risques de traumatisme

SUPER CUT

Regular Edge **SUPER CUT Edge**

Super Cut Scissors have specially designed cutting edges. One regular edge and **one sharp-knife edge**.

Extremely Sharp Razor Edge / Atraumatic
 Extrem Scharfe Spitzer Beck / Atraumatische
 Tranchant extrêmement aiguisée / Atraumatique
 Borde extremadamente afilado / Atraumática
 Taglio estremamente affilato / Atraumatica

One side serrated
 Eine seite gezahnt
 Un côté dentelé
 Un lado dentado
 Un lato dentellato

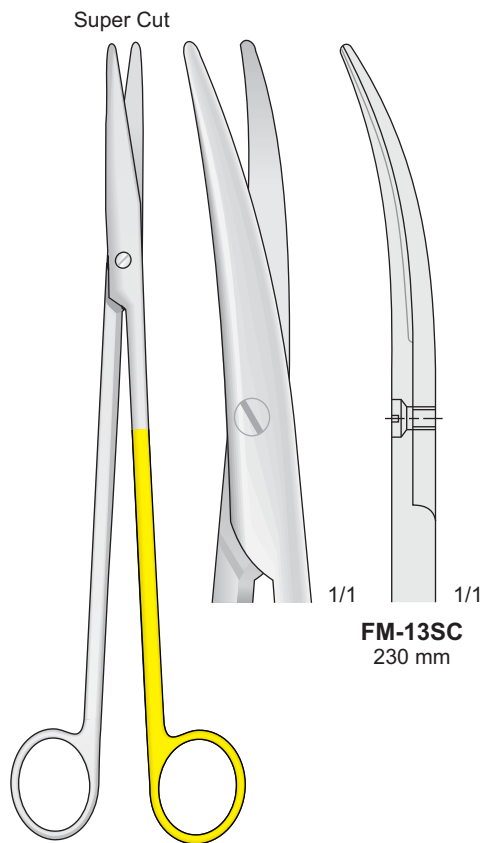
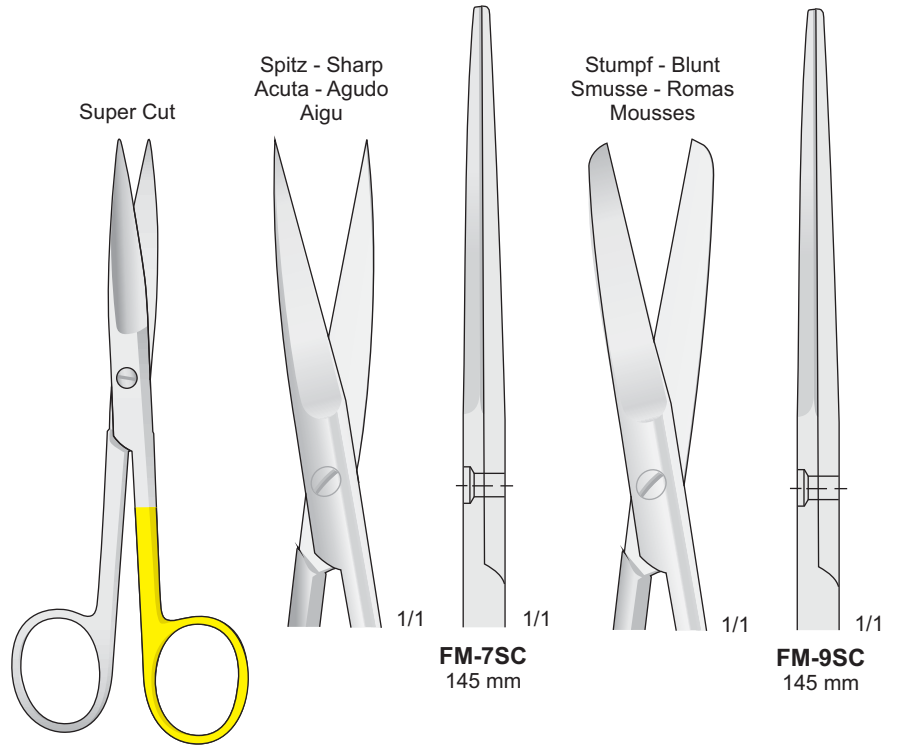

NELSON-METZENBAUM
FM-13SC
230 mm

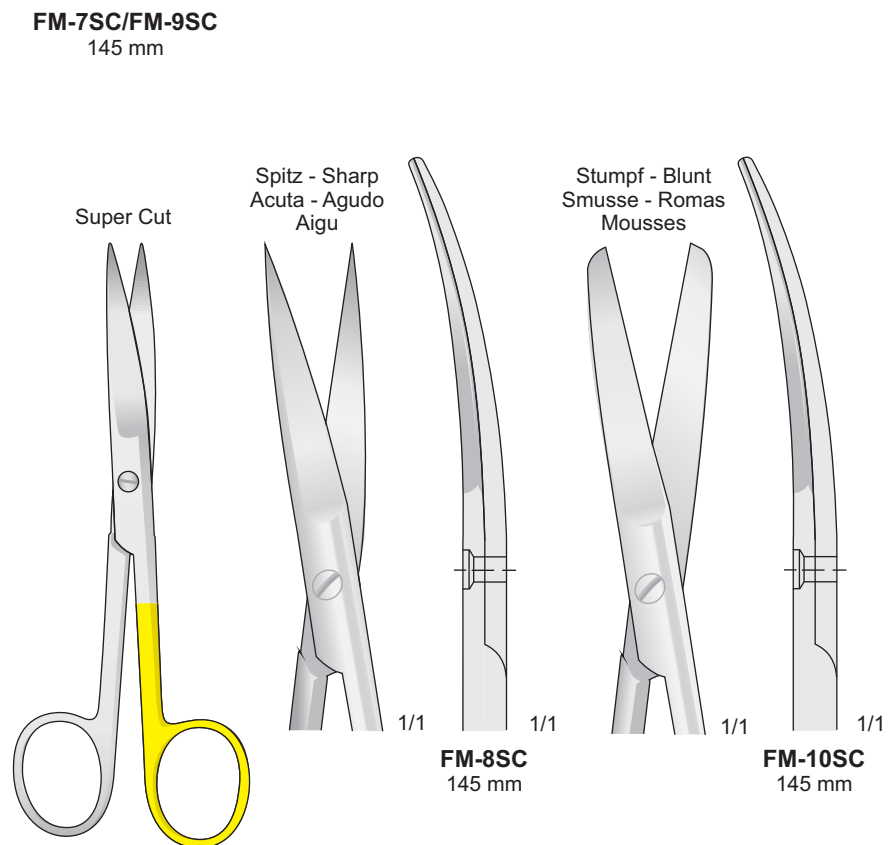

FM-8SC/FM-10SC
145 mm

SUPER CUT



Super Cut Scissors have specially designed cutting edges. One regular edge and **one sharp-knife edge.**



Extremely Sharp Razor Edge / Atraumatic
 Extrem Scharfe Spitzer Beck / Atraumatische
 Tranchant extrêmement aiguïssée / Atraumatique
 Borde extremadamente afilado / Atraumática
 Taglio estremamente affilato / Atraumatica



One side serrated
 Eine seite gezahnt
 Un côté dentelé
 Un lado dentado
 Un lato dentellato

Mit Hartmetalleinsätzen
 Tungsten-carbide scissors
 Con punta al carburo di tungsteno
 Tijeras de tungsteno
 Avec plaquettes en carbure de tungstène



Tungsten-Carbide Inserts
 Mit Hartmetalleinsätzen
 Plaquettes en carbure de tungstène
 Plaquetas de carburo de tungsteno
 Inserti in carburo di tungsteno

Mit eine Schneide gezahnt
 With one blade serrated
 Con una lama zigrinata
 Con una hoja dentada
 Avec lame dentèle

Mit eine Schneide gezahnt
 With one blade serrated
 Con una lama zigrinata
 Con una hoja dentada
 Avec lame dentèle

Super Cut

Super Cut
 TC

Mit eine Schneide gezahnt
 With one blade serrated
 Con una lama zigrinata
 Con una hoja dentada
 Avec lame dentèle

Super Cut
 TC

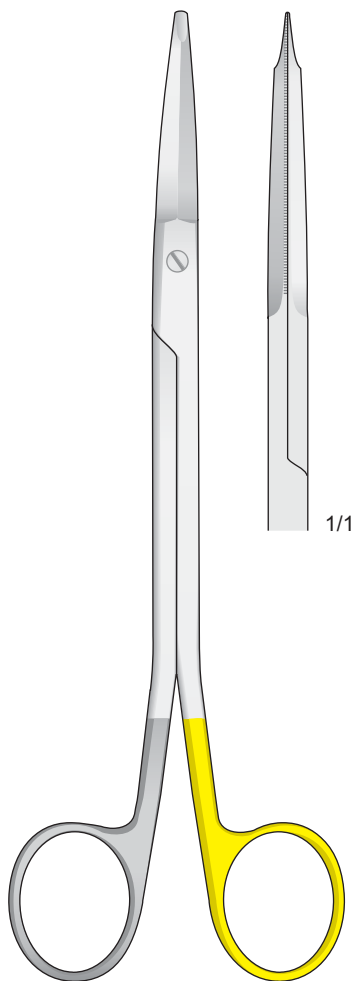

FREEMAN GORNEY
FM-310
 180 mm

Mit eine Schneide gezahnt
 With one blade serrated
 Con una lama zigrinata
 Con una hoja dentada
 Avec lame dentèle

Super Cut
 TC

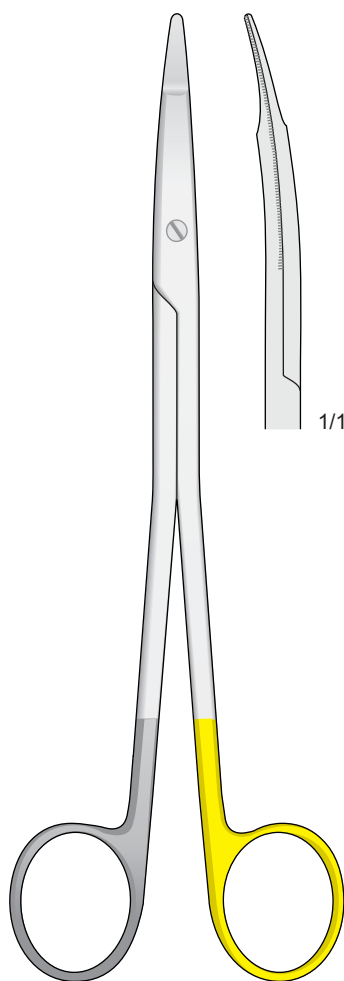

FREEMAN
FM-330
 180 mm

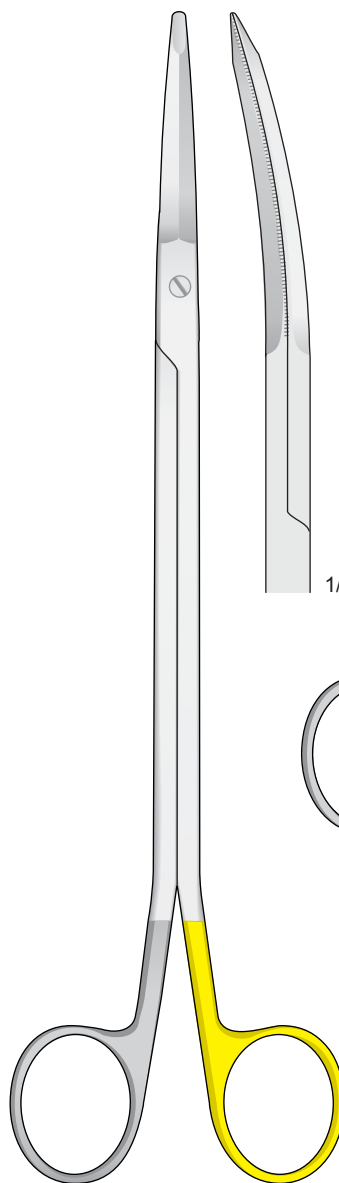

GORNEY
FM-331
 230 mm

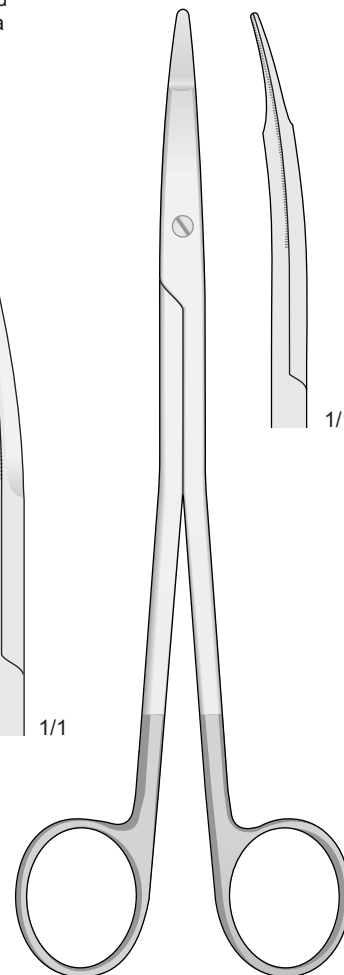

FREEMAN
FM-328
 180 mm

Mit Hartmetalleinsätzen
Tungsten-carbide scissors
Con punta al carburo di tungsteno
Tijeras de tungsteno
Avec plaquettes en carbure de tungstène



Tungsten-Carbide Inserts
Mit Hartmetalleinsätzen
Plaquettes en carbure de tungstène
Plaquetas de carburo de tungsteno
Inserti in carburo di tungsteno

Mit eine Schneide gezahnt
With one blade serrated
Con una lama zigrinata
Con una hoja dentada
Avec lame dentèle

Mit eine Schneide gezahnt
With one blade serrated
Con una lama zigrinata
Con una hoja dentada
Avec lame dentèle

Mit eine Schneide gezahnt
With one blade serrated
Con una lama zigrinata
Con una hoja dentada
Avec lame dentèle

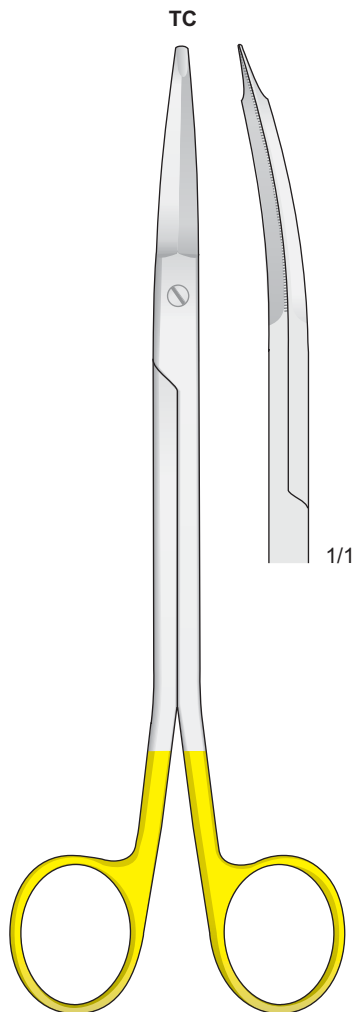

FREEMAN KAYE
FM-335
180 mm

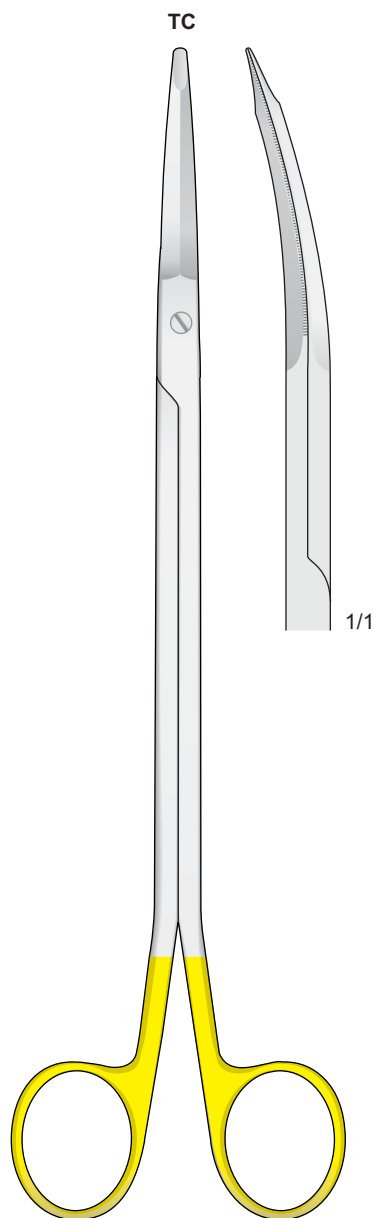

GORNEY
FM-312
230 mm

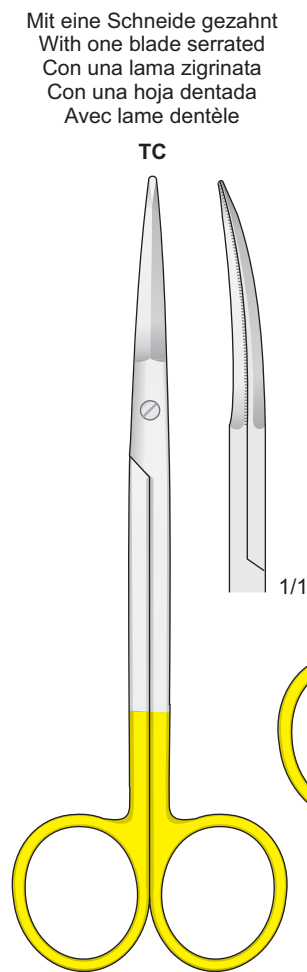

GREGORY
FM-339
140 mm

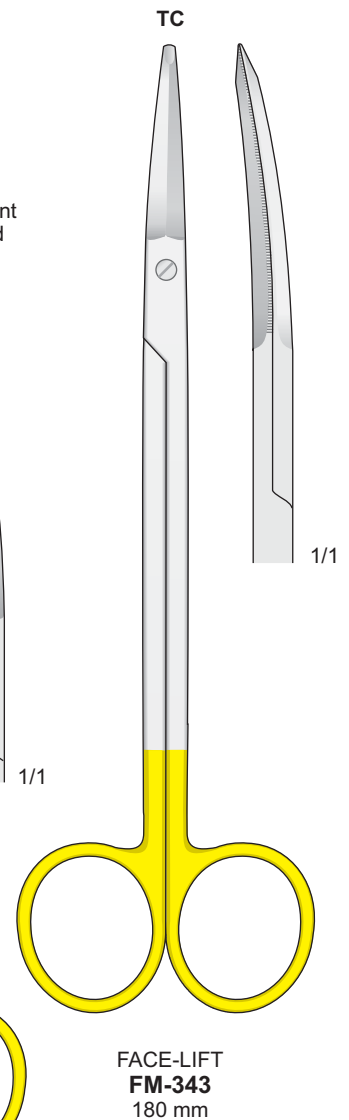

FACE-LIFT
FM-343
180 mm

Pinzette mit Häkchen
Suturing Forceps
Pinzette per suture

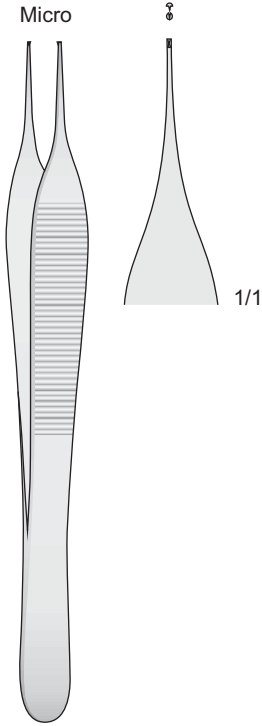

ADSON
BD-177
150 mm

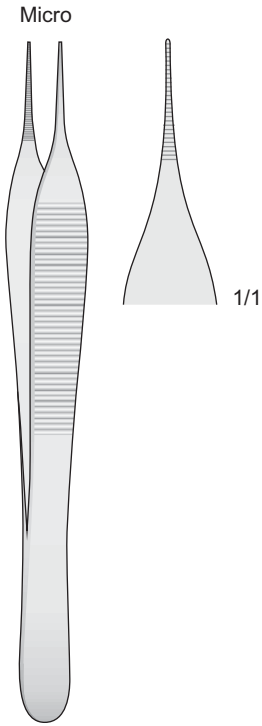

ADSON
BD-178
150 mm

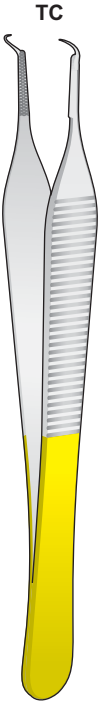

ADSON
BD-300
125 mm



ADSON-BROWN
BD-253
120 mm

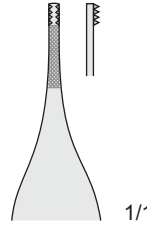

TC
TUNGSTEN
CARBIDE
Tungsten-Carbide Inserts
Mit Hartmetalleinsätzen
Plaquettes en carbure de tungstène
Plaquetas de carburo de tungsteno
Inserti in carburo di tungsteno

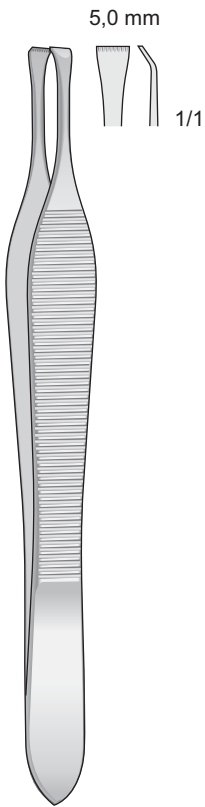

BEASLEY-BABCOCK
BD-51
120 mm

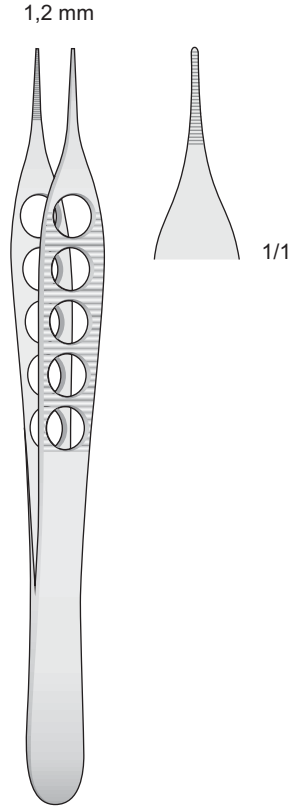

ADSON
BD-207
120 mm

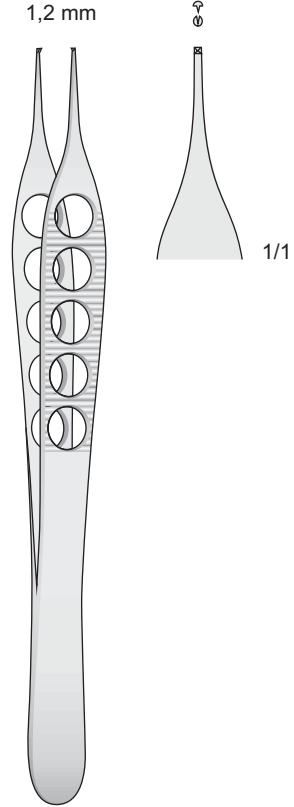

ADSON
BD-208
120 mm

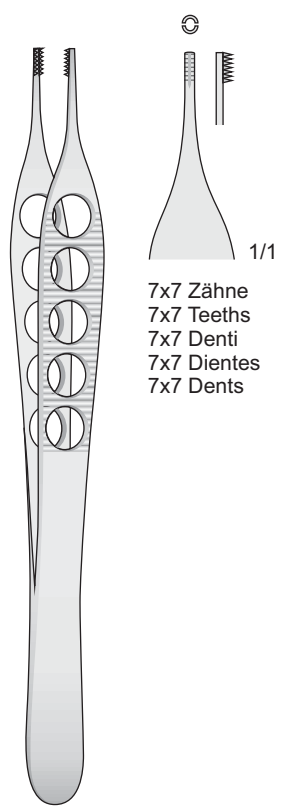

ADSON-BROWN
BD-209
120 mm

7x7 Zähne
7x7 Teeth
7x7 Denti
7x7 Dientes
7x7 Dents

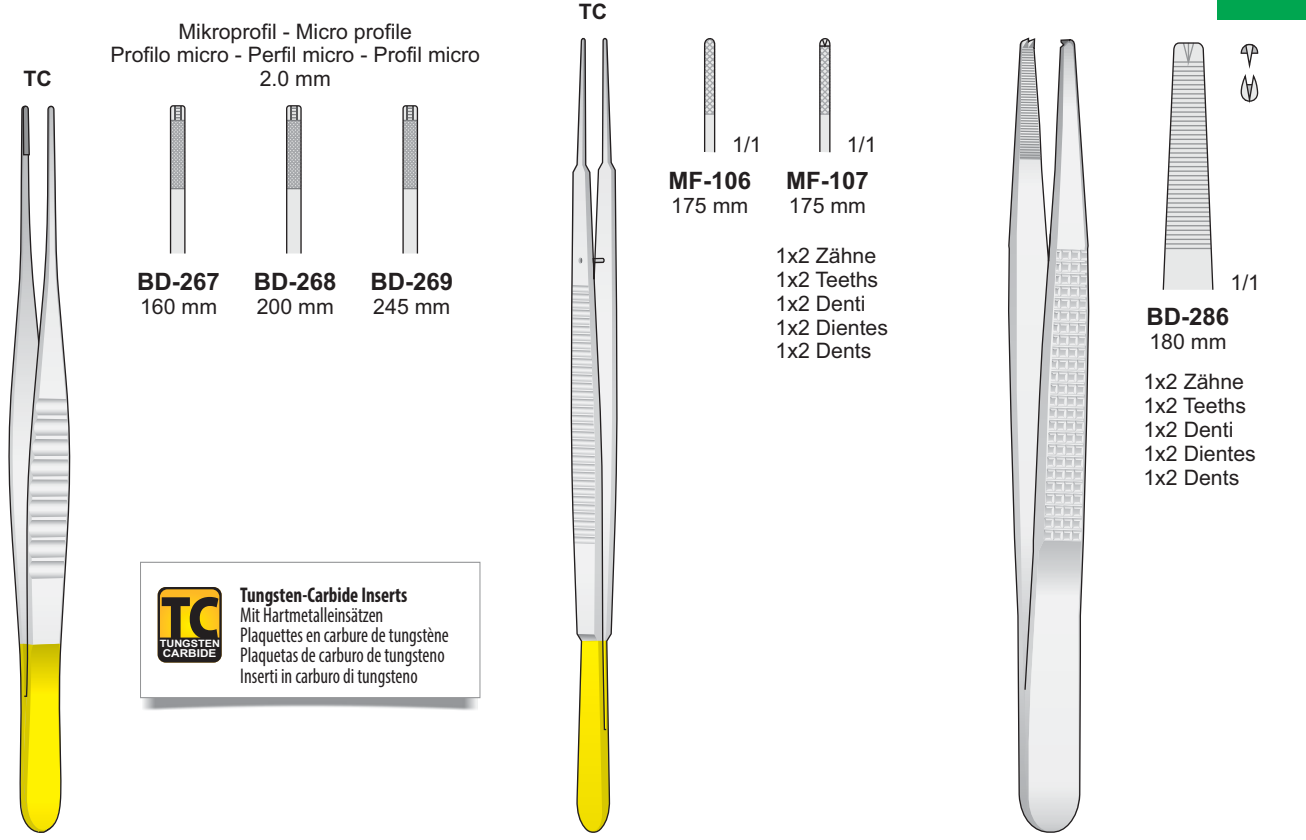

Mikroprofil - Micro profile
Profilo micro - Perfil micro - Profil micro
2.0 mm

BD-267 160 mm
BD-268 200 mm
BD-269 245 mm

MF-106
175 mm

MF-107
175 mm

1x2 Zähne
1x2 Teeth
1x2 Denti
1x2 Dientes
1x2 Dents

BD-286
180 mm

1x2 Zähne
1x2 Teeth
1x2 Denti
1x2 Dientes
1x2 Dents

TC
Tungsten-Carbide Inserts
Mit Hartmetalleinsätzen
Plaquettes en carbure de tungstène
Plaquetas de carburo de tungsteno
Inserti in carburo di tungsteno

DE BAKEY
BD-267/BD-269

GERALD
MF-106/MF-107
175 mm

BONNEY
BD-286
180 mm

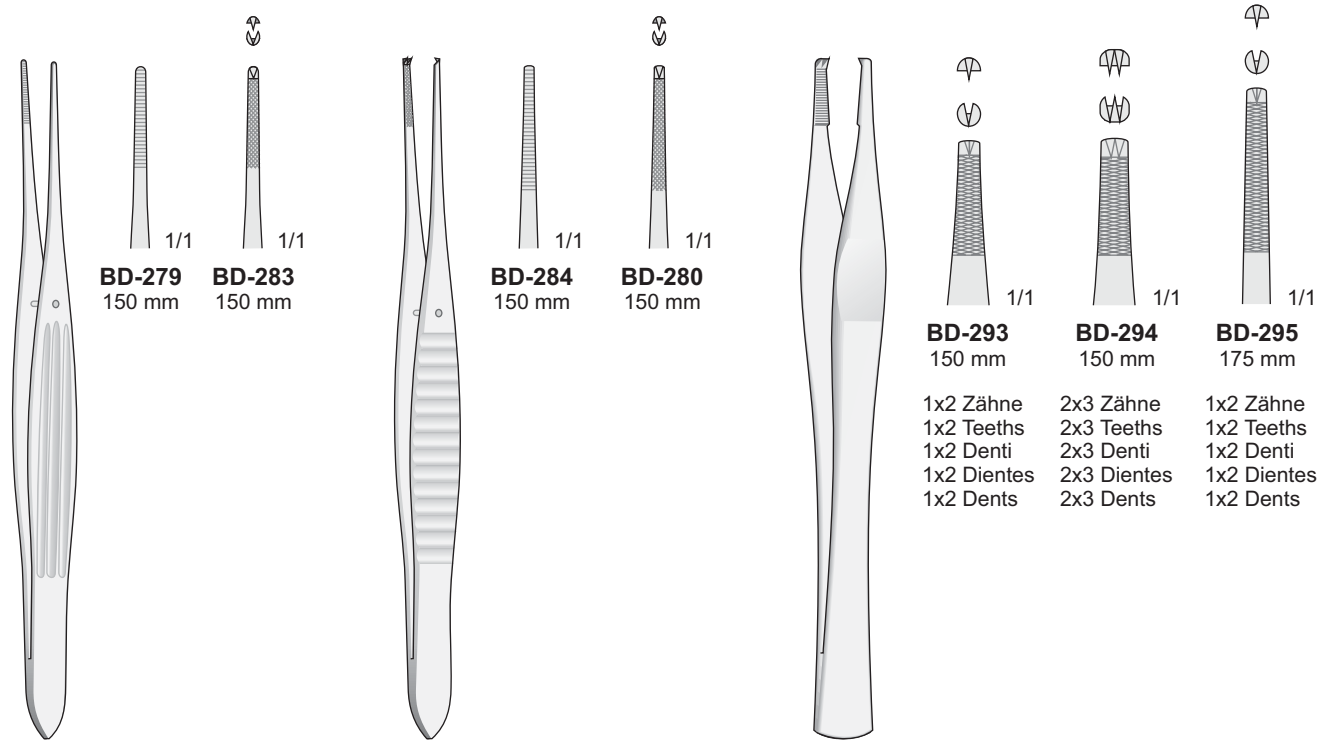

BD-279
150 mm

BD-283
150 mm

BD-284
150 mm

BD-280
150 mm

BD-293
150 mm

BD-294
150 mm

BD-295
175 mm

1x2 Zähne
1x2 Teeth
1x2 Denti
1x2 Dientes
1x2 Dents

2x3 Zähne
2x3 Teeth
2x3 Denti
2x3 Dientes
2x3 Dents

1x2 Zähne
1x2 Teeth
1x2 Denti
1x2 Dientes
1x2 Dents

McINDOE
BD-279/BD-283
150 mm

GILLIES
BD-280/BD-284
150 mm

LANE
BD-293/BD-295

Titan - Titanium - Titano - Titane

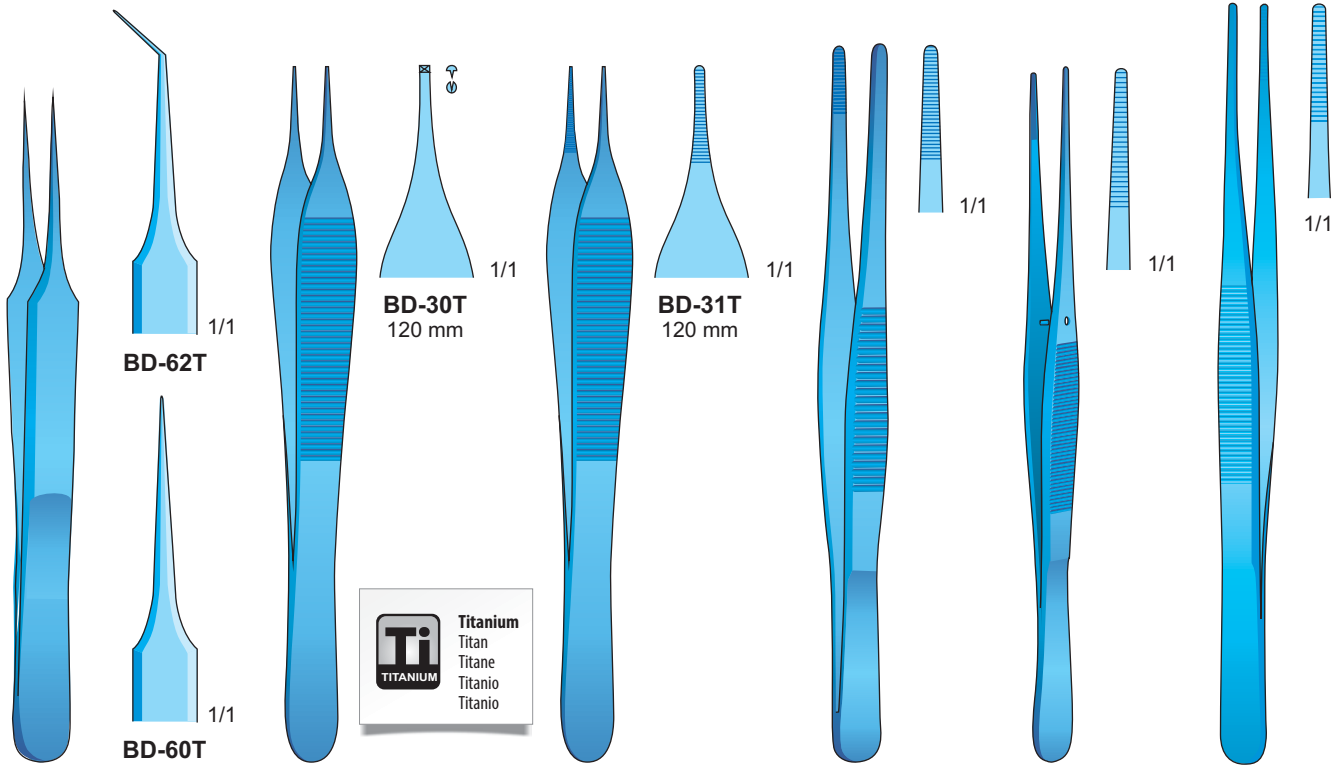

BD-60T/BD-62T
110 mm

ADSON
BD-30T
120 mm

ADSON
BD-31T
120 mm

BD-75T
145 mm

BD-09T
130 mm

BD-16T
160 mm

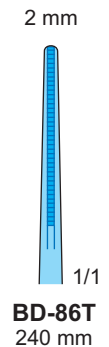
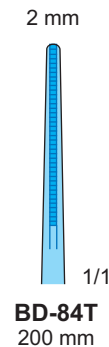
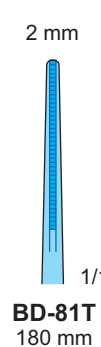
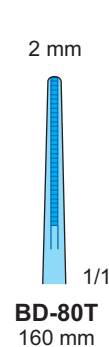
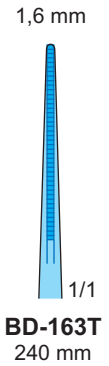
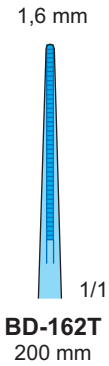
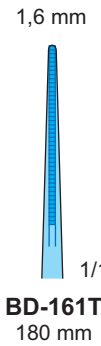
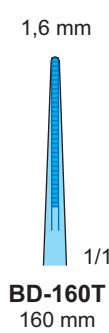
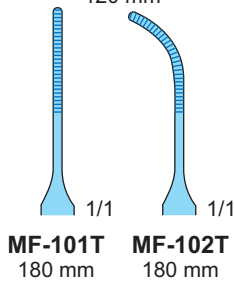
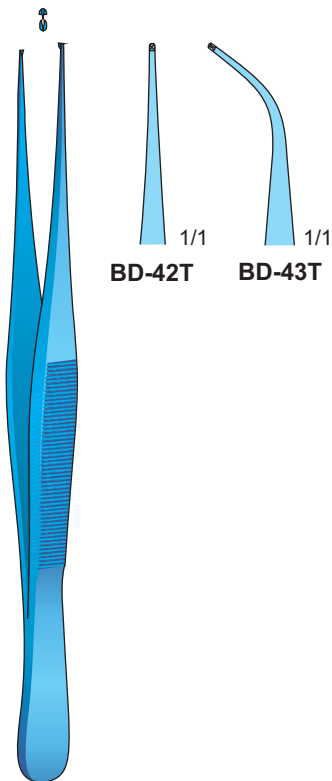

BD-42T/BD-43T
110 mm

GERALD
MF-101T/MF-102T
180 mm

DE BAKEY
BD-80T/BD-163T



BD-351/BD-353

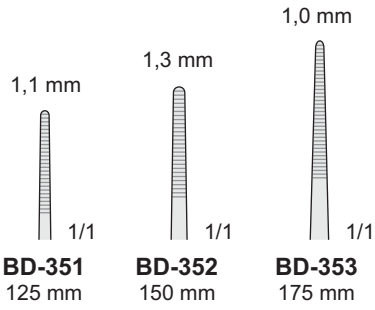

BD-354/BD-356

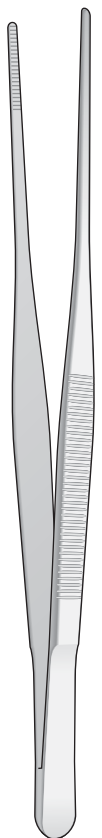
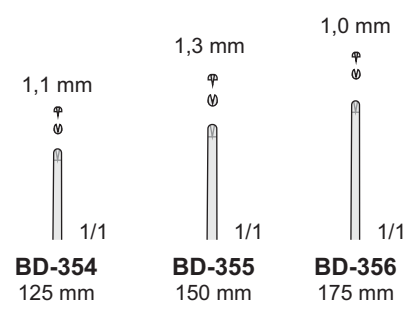

BD-69
200 mm

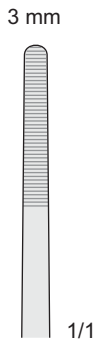

TAYLOR
BD-264
175 mm

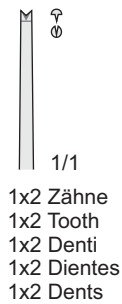

TAYLOR
BD-265
170 mm

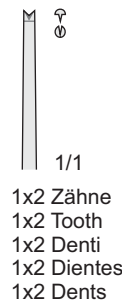

TAYLOR
BD-266
185 mm

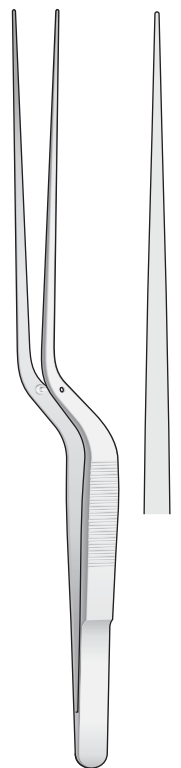
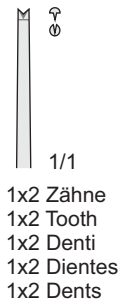

BD-197
185 mm

Mit Schaberende - With dissector end
Con estremità a forma di raschino
Con rascador - À rugine

Glattes Maul
Smooth Jaws
Morso liscio

19



Isoliert - Insulated - Isolate - Aislante - Isolant
Monopolar - Monopolar

mit sterilisierfähiger Kunststoff-Isolierbeschichtung - with autoclavable plastic coated insulated handles
 con rivestimento isolante in plastica sterilizzabile - con recubrimiento aislante de materia plástica esterilizable
 à enduit plastique isolant, stérilisable

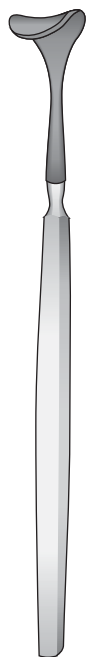

DESMARRES
BT-490/BT-493
 140 mm

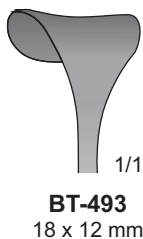
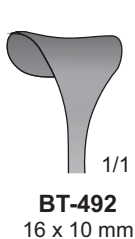
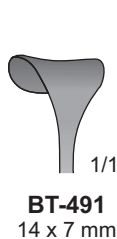

BD-10IS
 145 mm



BD-20IS
 200 mm



BD-23IS
 230 mm



BD-24IS
 250 mm



BD-194IS
 100 mm



BD-273IS
 155 mm



BD-277IS
 250 mm



BD-26IS
 300 mm

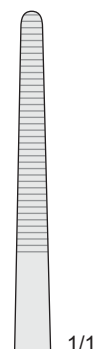

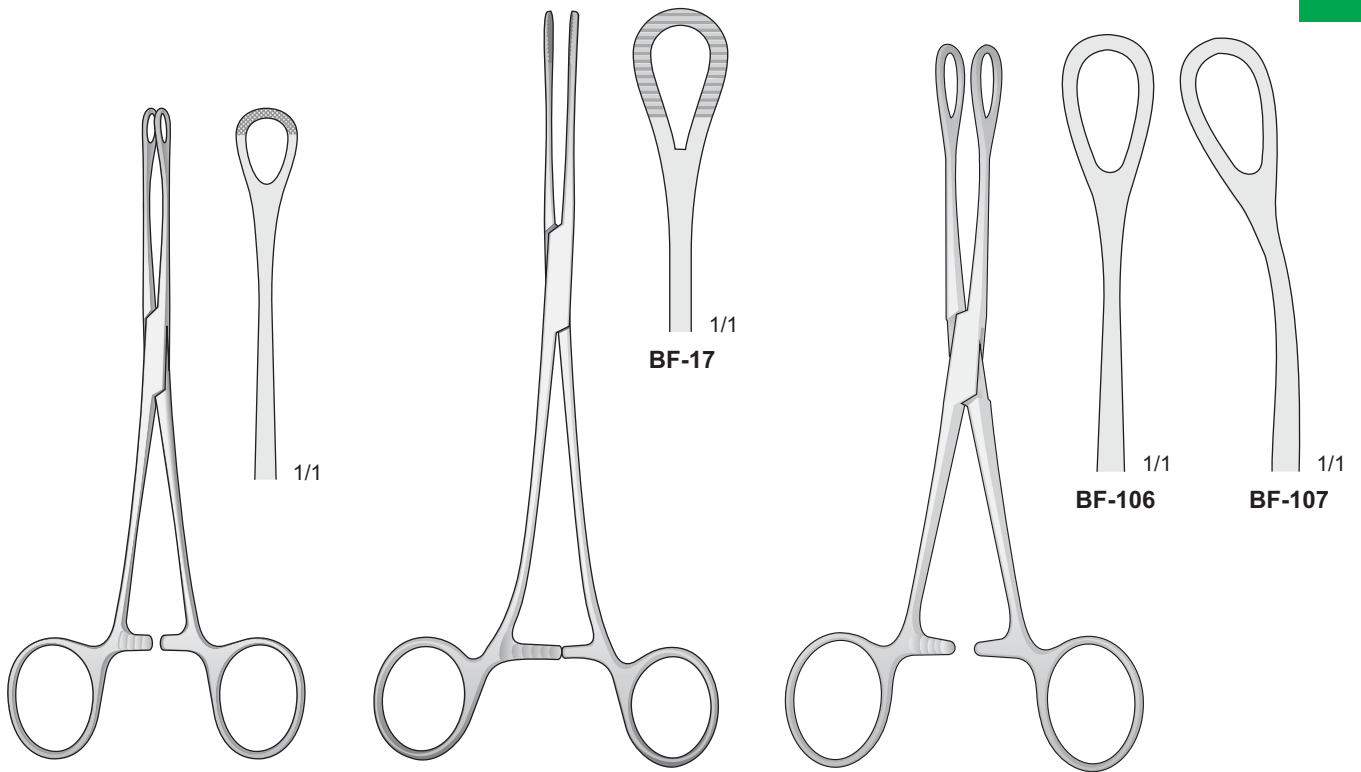

WILLIAMS
P-325
165 mm

BF-17
200 mm

FOERSTER
BF-106/BF-107
180 mm

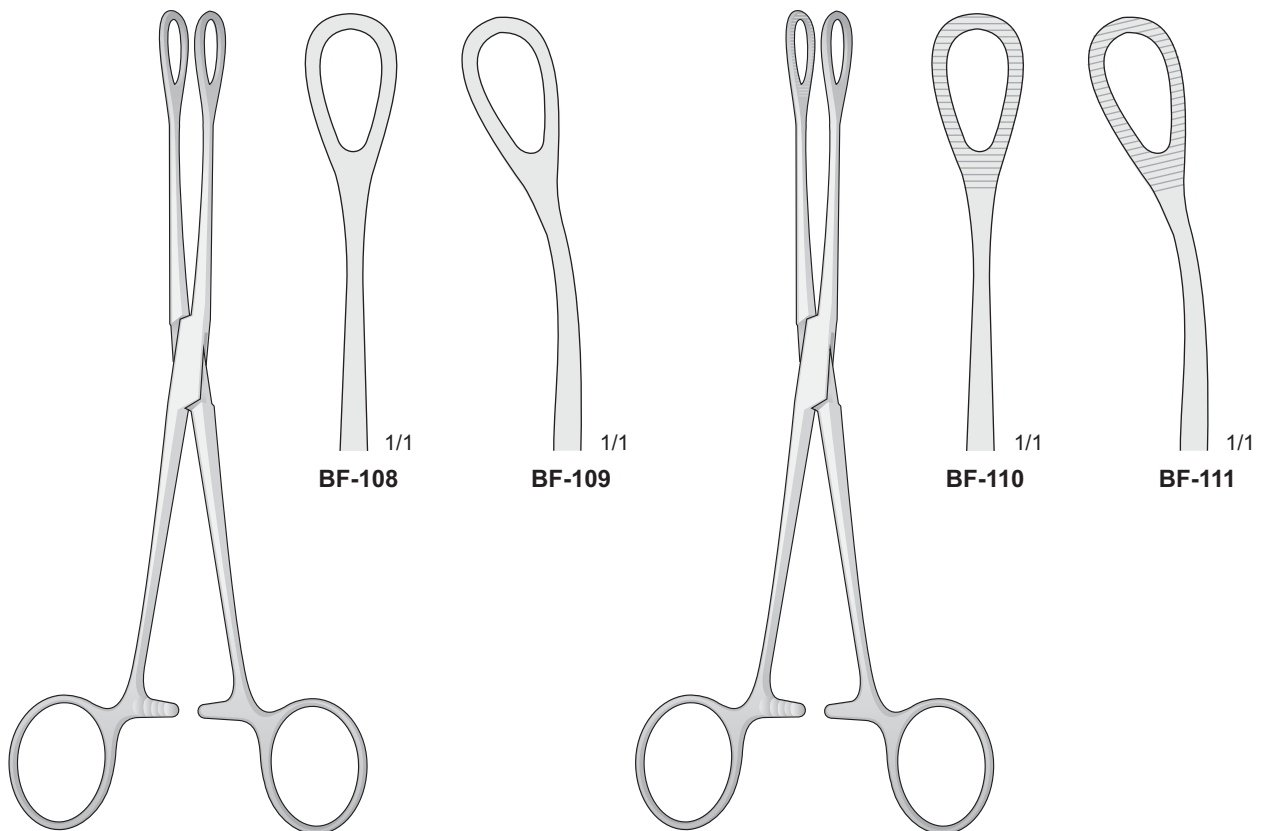

FOERSTER
BF-108/BF-109
200 mm

FOERSTER
BF-110/BF-111
200 mm

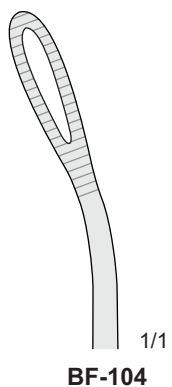
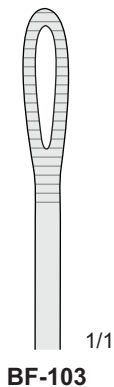
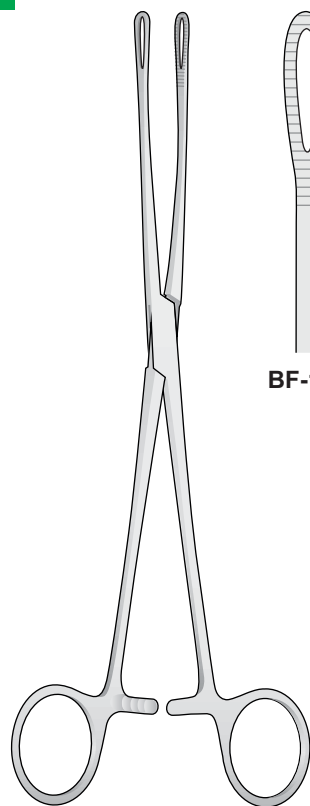

FOERSTER
BF-103/BF-104
250 mm

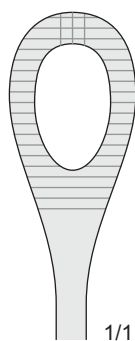
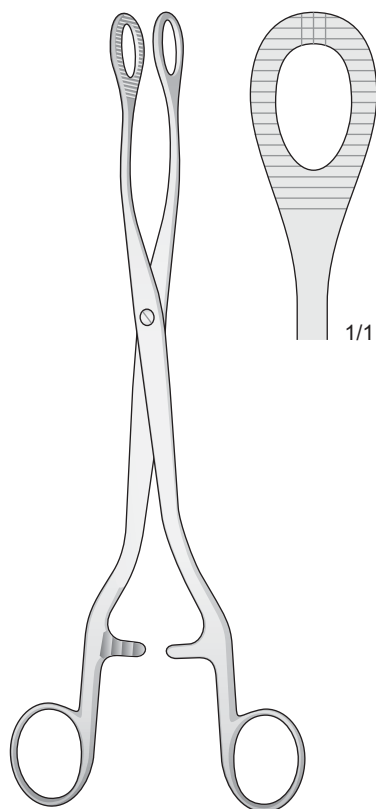

HEYWOOD-SMITH
EB-98
250 mm

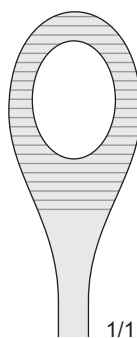
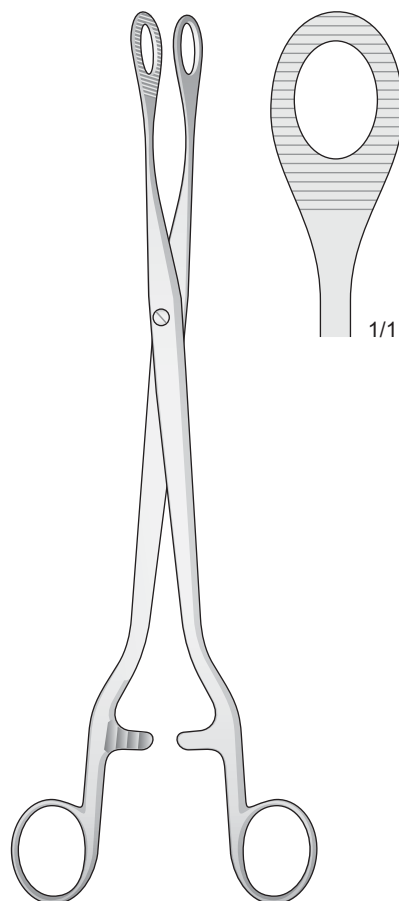

NOTO
EB-99
280 mm

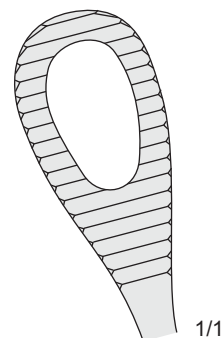
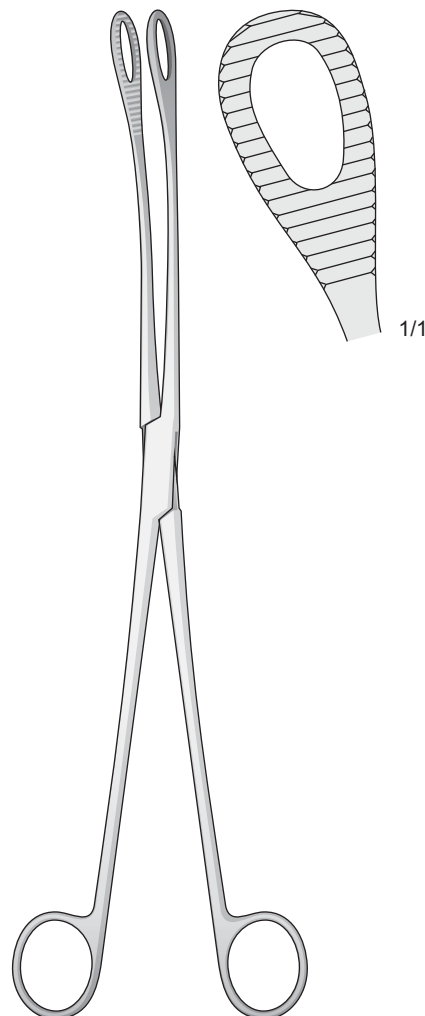

KELLY
BF-102
320 mm

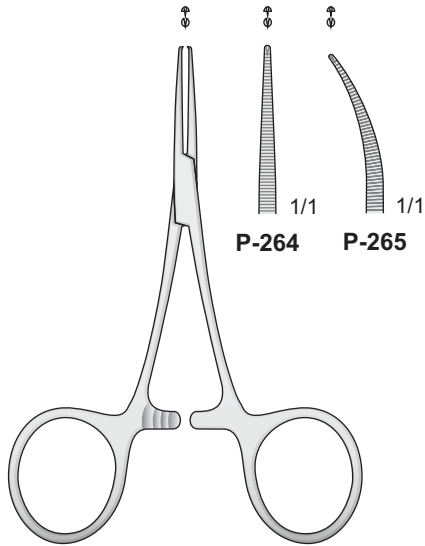

HARTMANN-BABY-MOSQUITO
P-264/P-265
95 mm

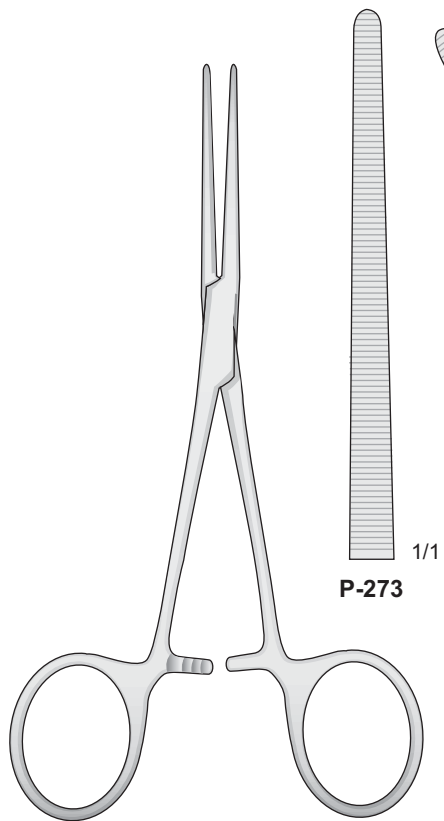

ROCHESTER-PEAN
P-273/P-276
225 mm

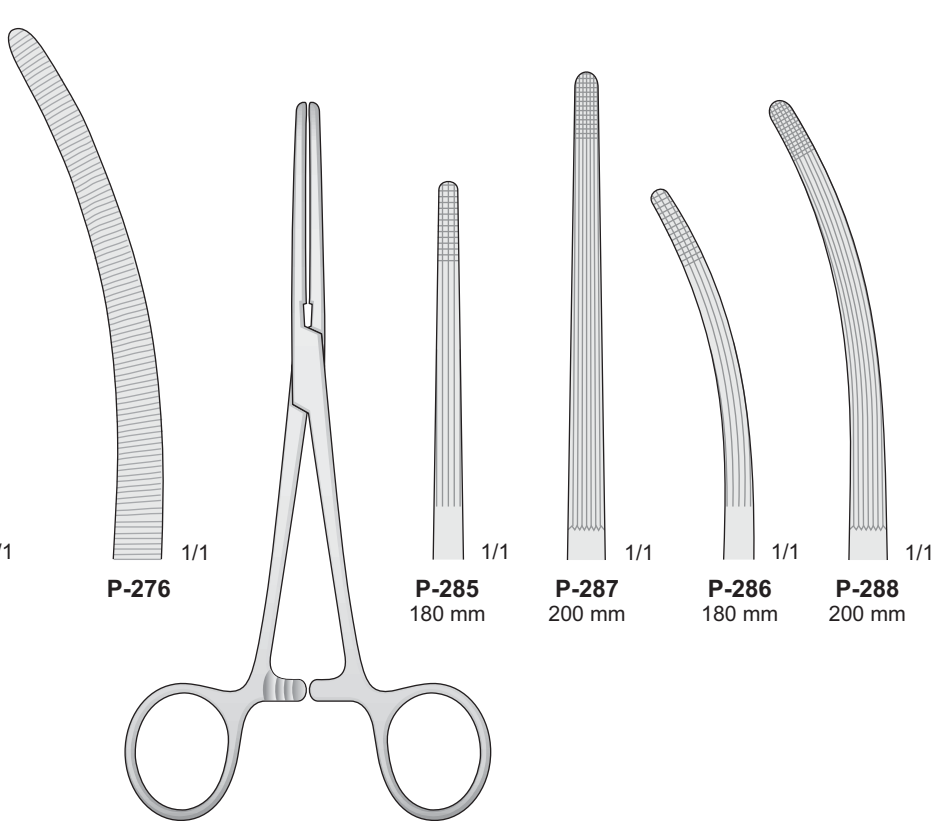

ROCHESTER-CARMALT
P-285/P-288

19

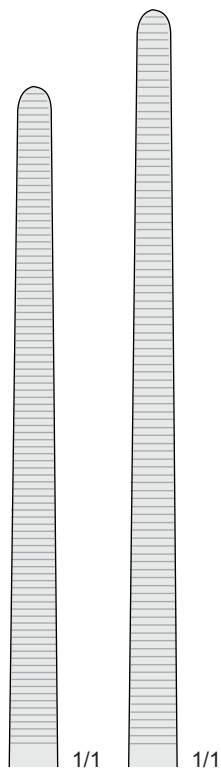

P-274
260 mm

P-275
280 mm

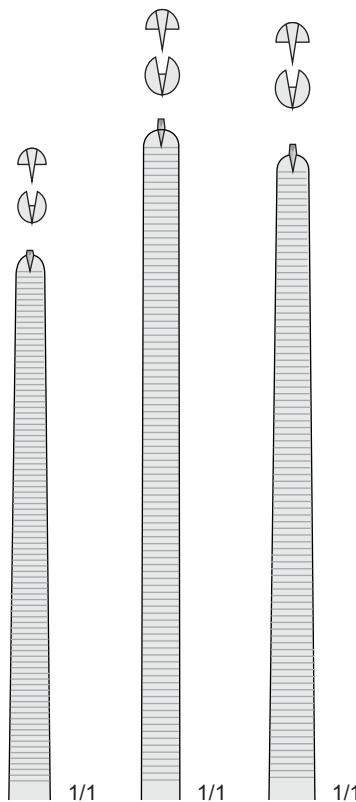

P-279
225 mm

P-280
260 mm

P-281
280 mm

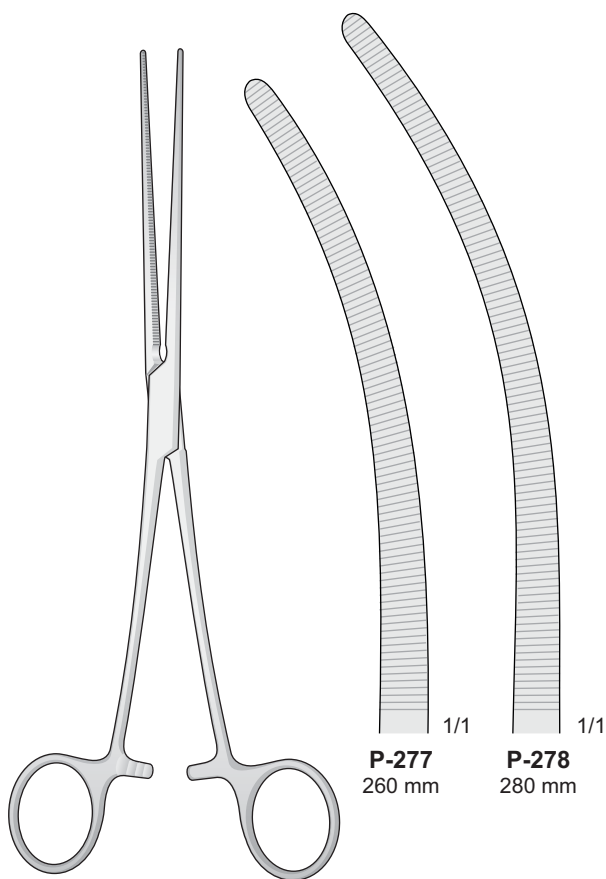

PEAN
P-274/P-278

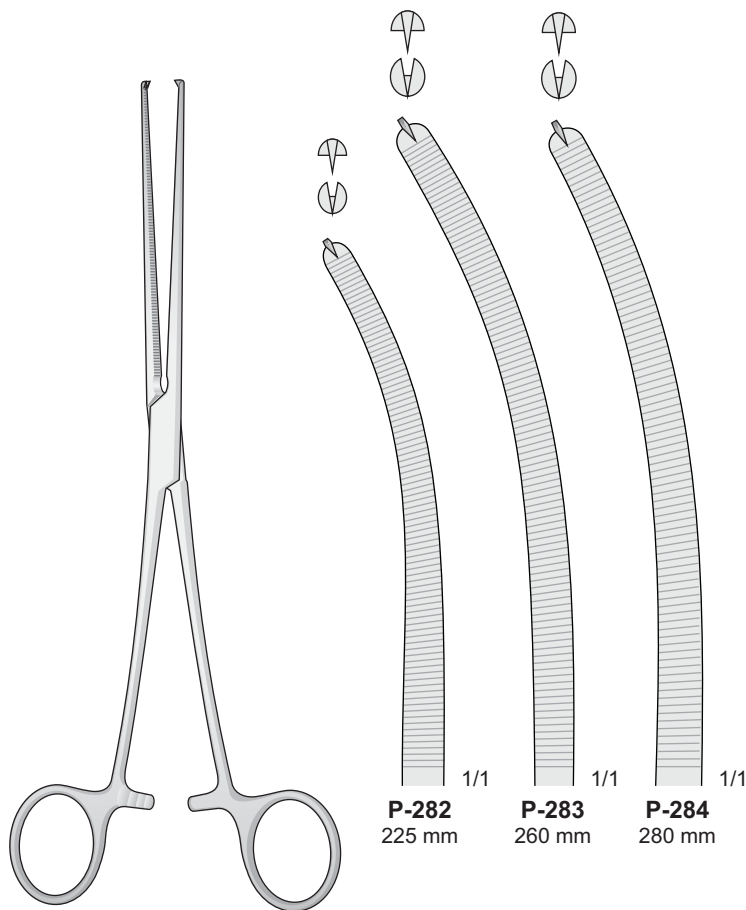

KOCHER-OCHSNER
P-279/P-284

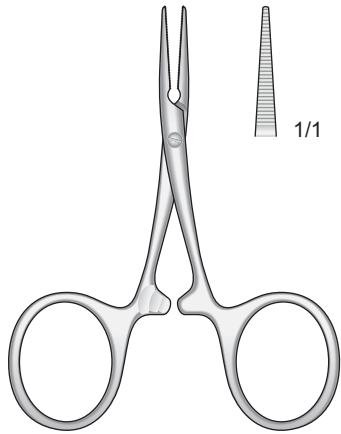

CARREL
P-323
85 mm

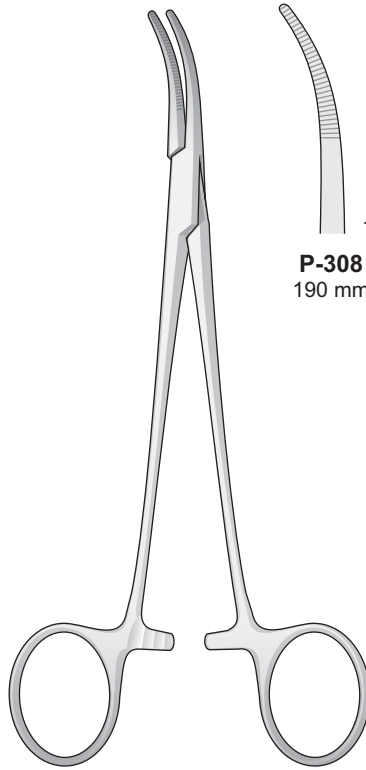

SCHNIDT
P-308/P-309
190 mm

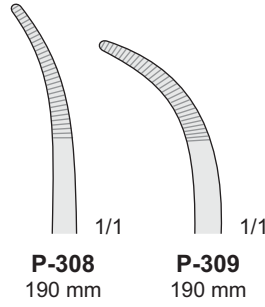

P-308
190 mm

P-309
190 mm

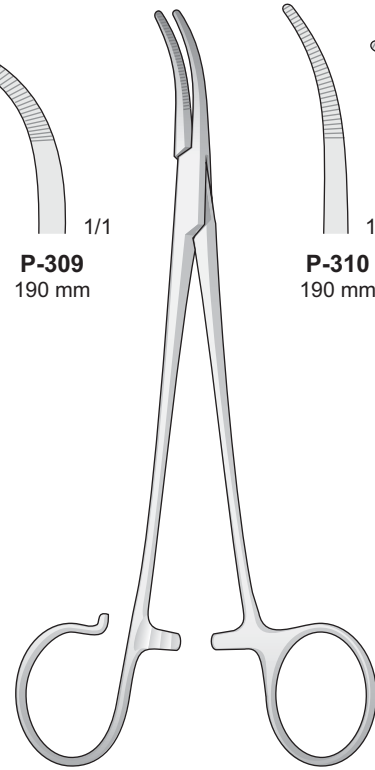

SCHNIDT
P-310/P-311
190 mm

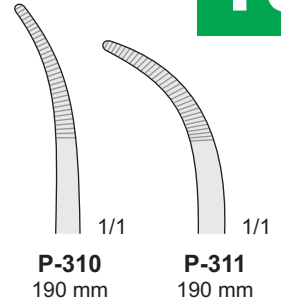

P-310
190 mm

P-311
190 mm

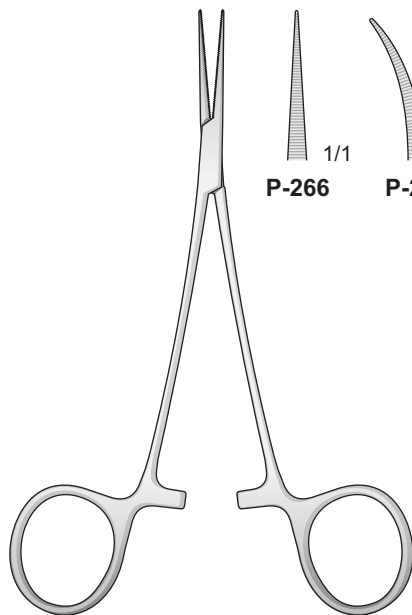

JACOBSON-MICRO
P-266/P-267
130 mm

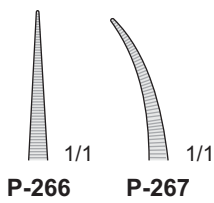

P-266

P-267

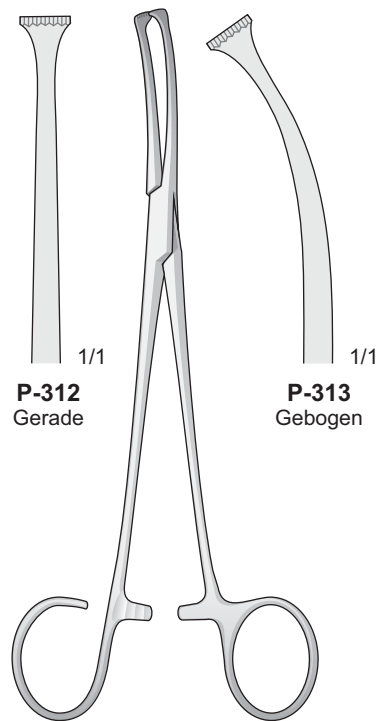

COLVER
P-312/P-313
190 mm

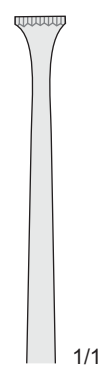

P-312
Gerade

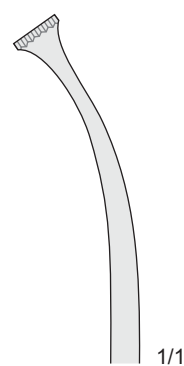

P-313
Gebogen

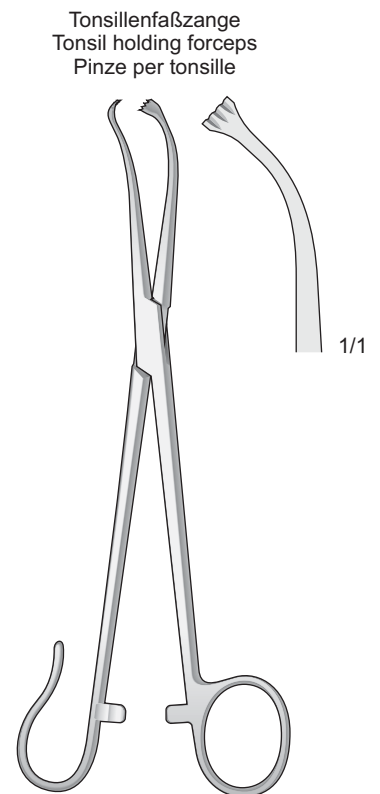

WHITE
P-331
180 mm

Tonsillenfaßzange
Tonsil holding forceps
Pinze per tonsille

19

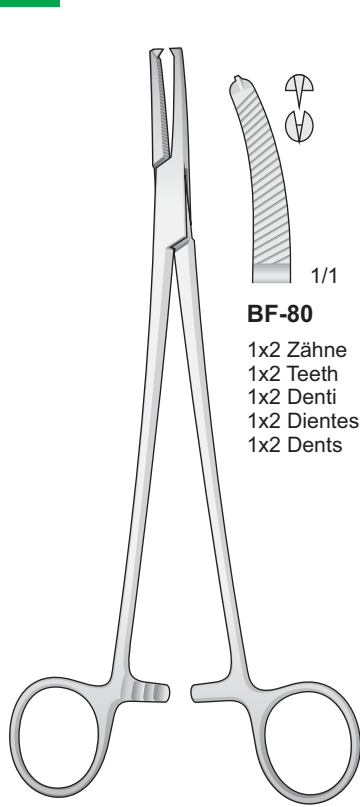

BF-80

1x2 Zähne
1x2 Teeth
1x2 Denti
1x2 Dientes
1x2 Dents

BF-81

1x2 Zähne
1x2 Teeth
1x2 Denti
1x2 Dientes
1x2 Dents

FAURE
BF-80/BF-81
200 mm

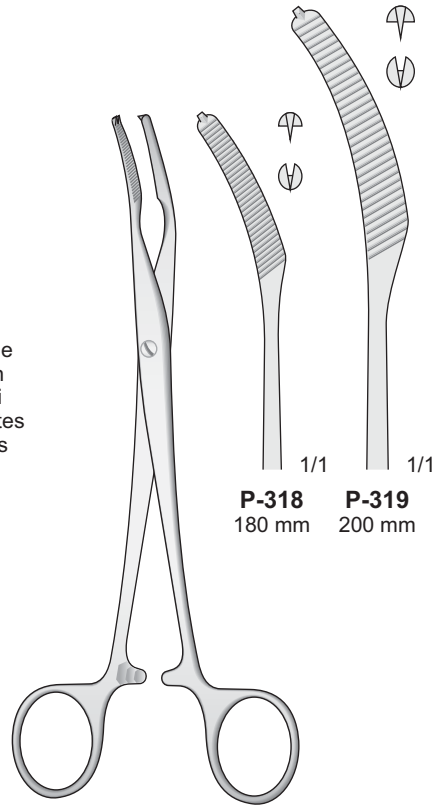

P-318
180 mm

P-319
200 mm

MIKULICZ
P-318/P-319

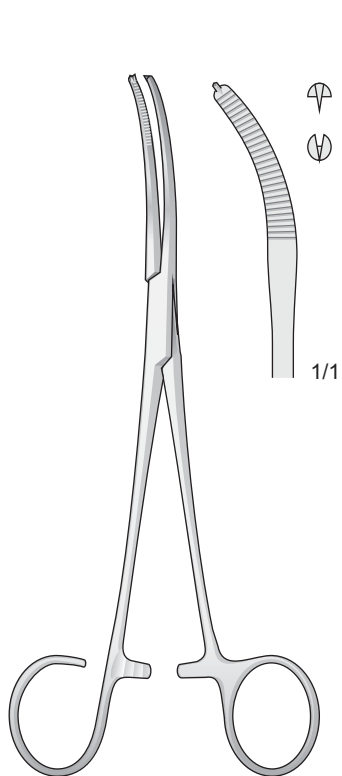

MIKULICZ
P-322
185 mm

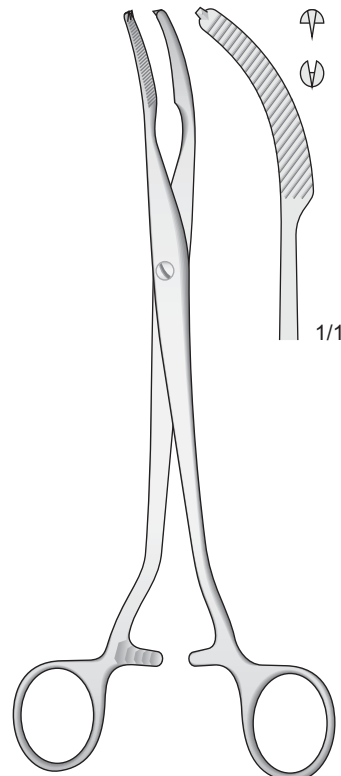

MIKULICZ
P-320
200 mm

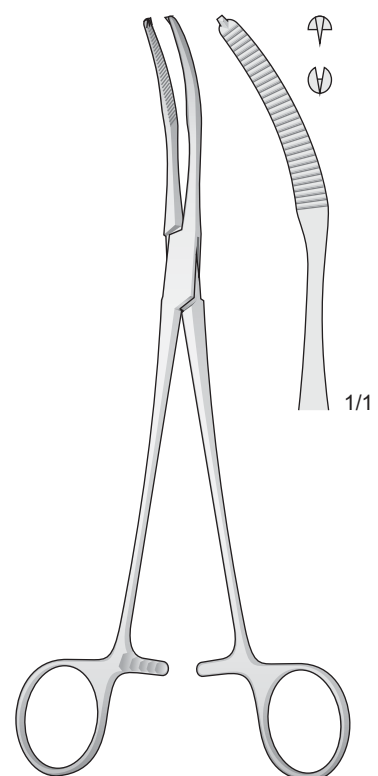

MIKULICZ
P-321
200 mm

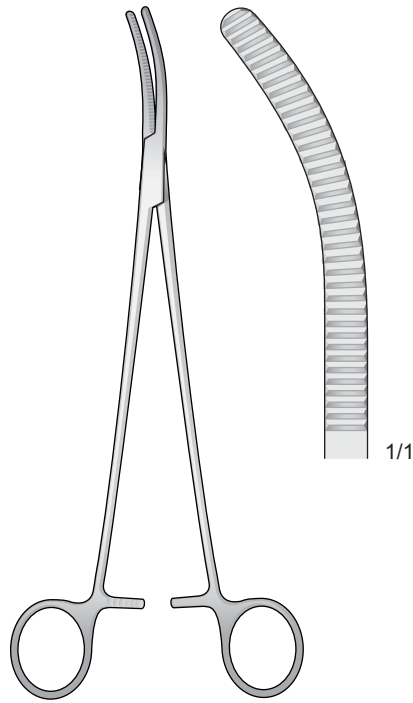

WERTHEIM
P-289
250 mm

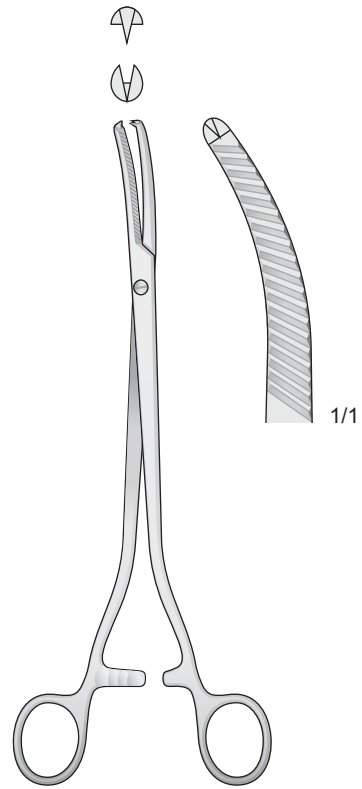

WERTHEIM
FB-222
230 mm

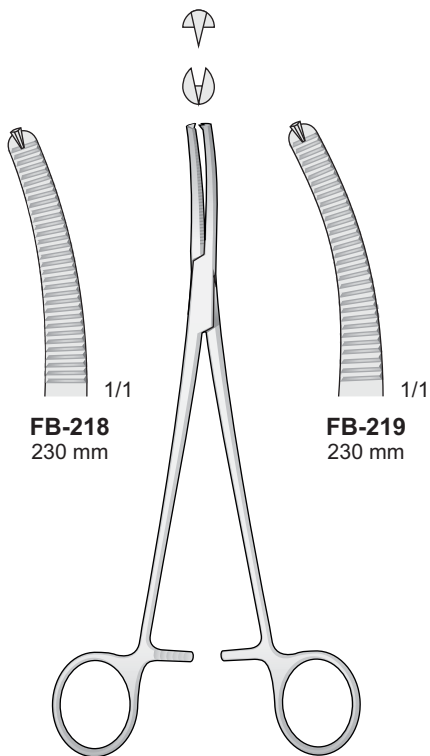

FB-218
230 mm

FB-219
230 mm

WERTHEIM
FB-218/FB-219
230 mm

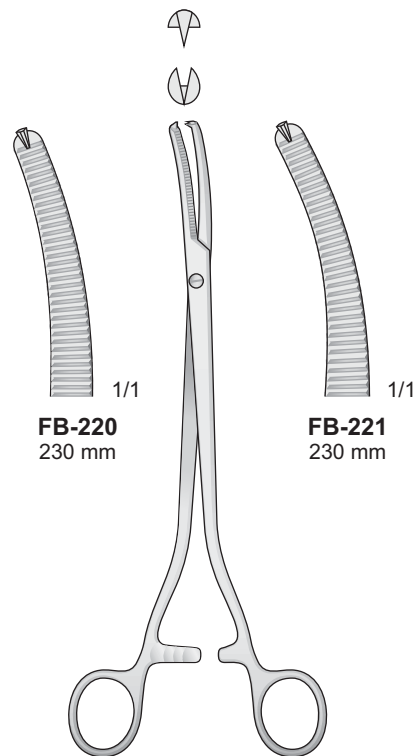

FB-220
230 mm

FB-221
230 mm

WERTHEIM
FB-220/FB-221
230 mm

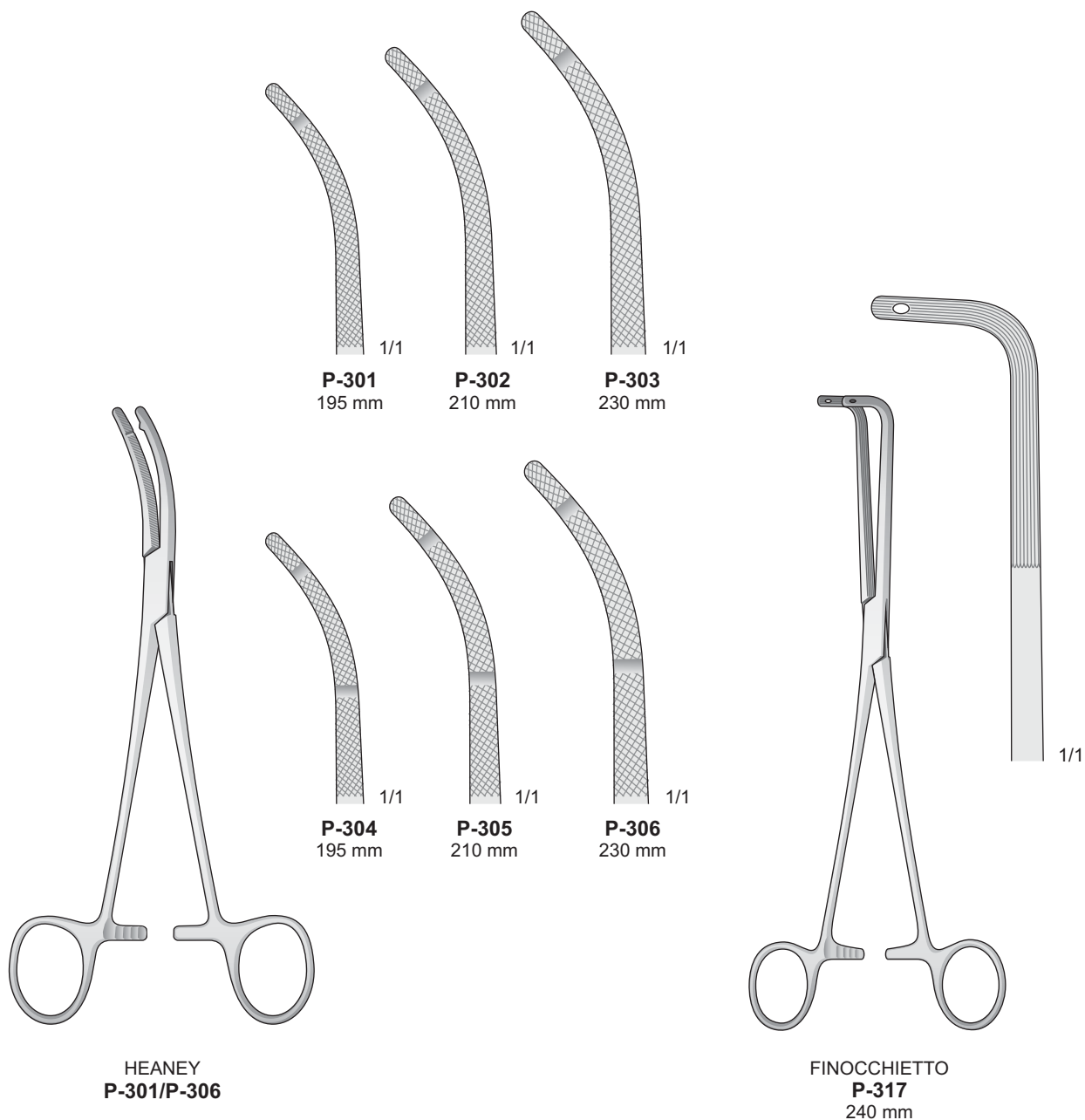

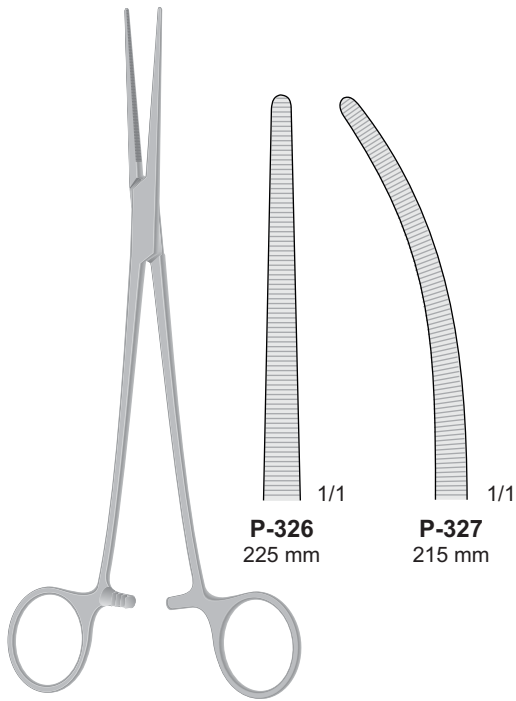

ROBERTS
P-326/P-327

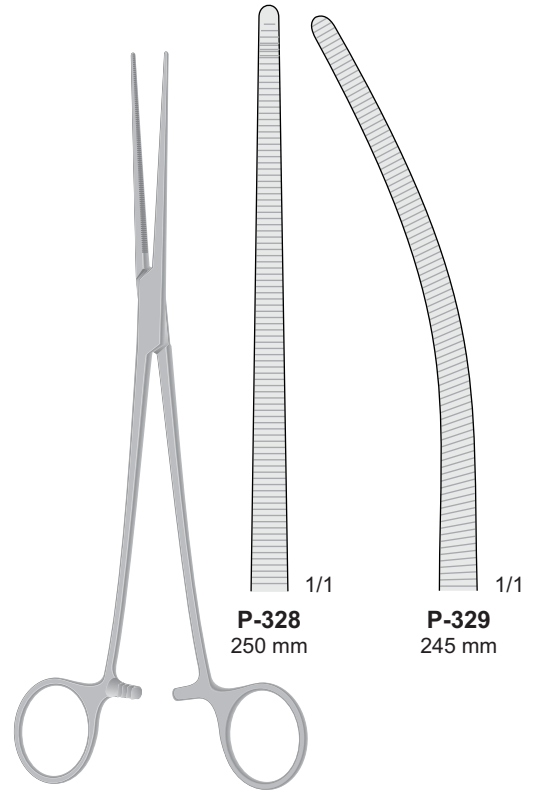

SAROT
P-328/P-329

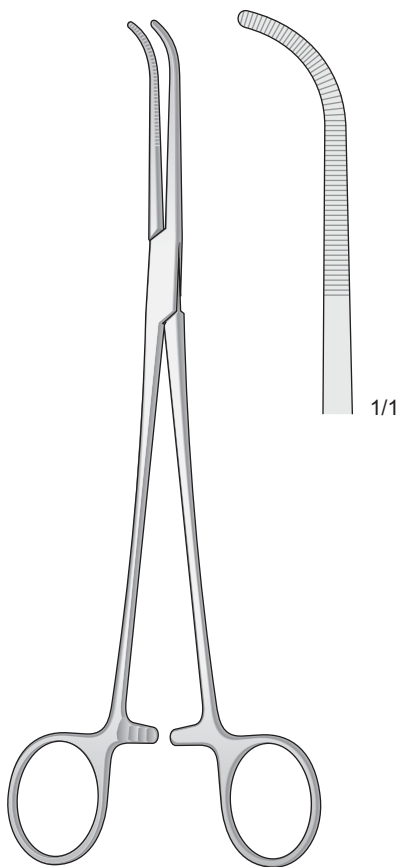

MIXTER
P-116
225 mm

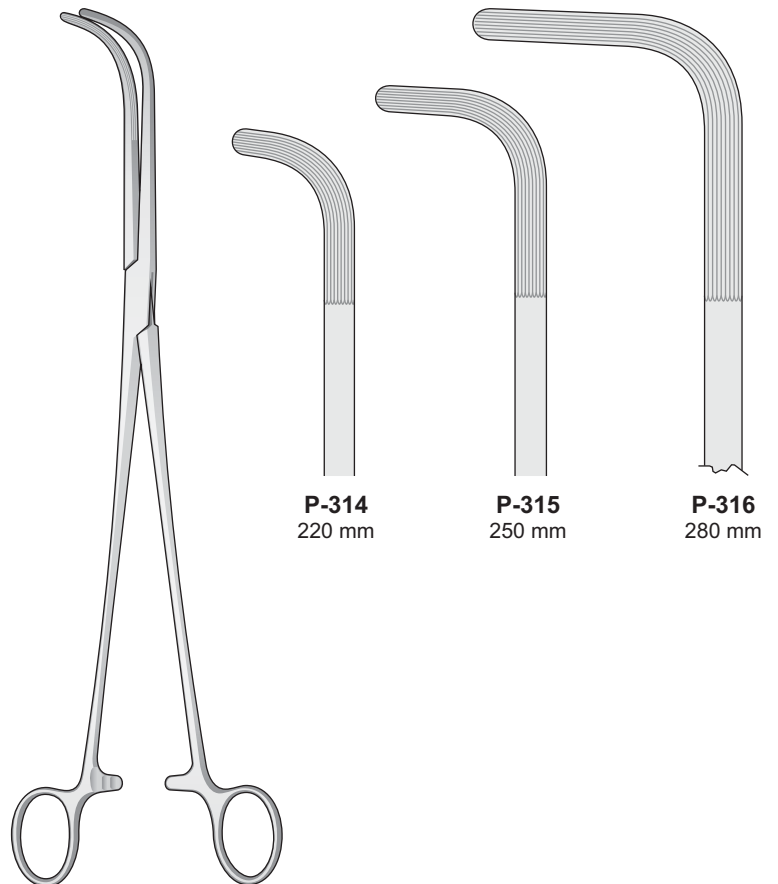

MIXTER
P-314/P-316

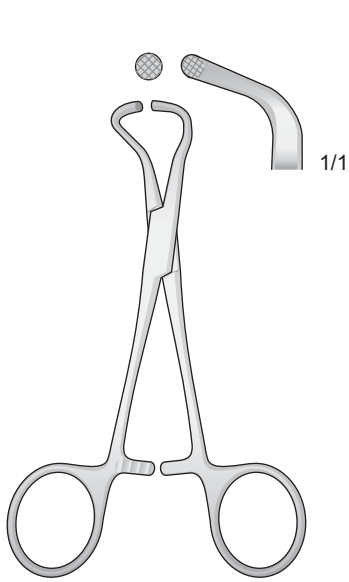

BF-76
100 mm

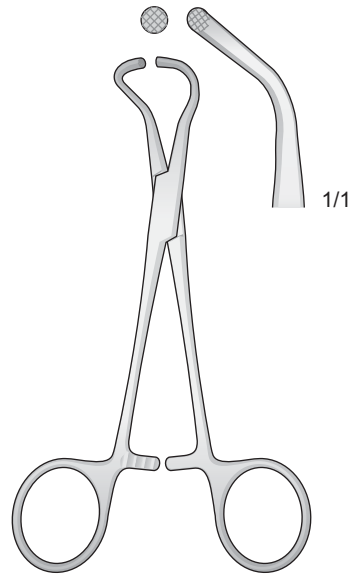

BF-77
125 mm

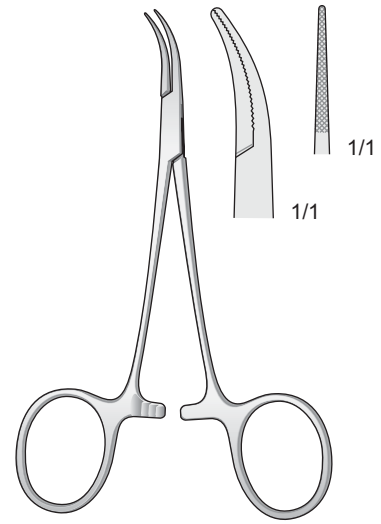

DANDY-MOSQUITO
P-332
120 mm

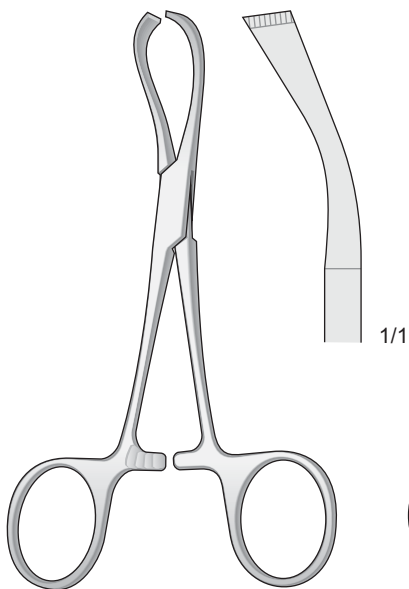

LORNA
BF-71
130 mm

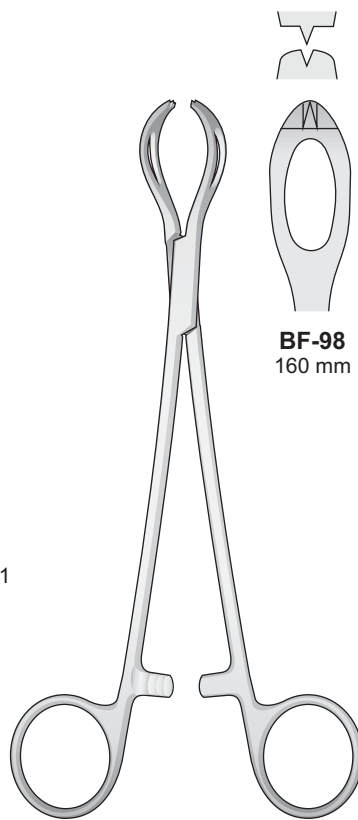

LANE
BF-98/BF-99

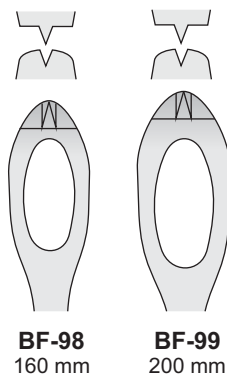

BF-98
160 mm

BF-99
200 mm

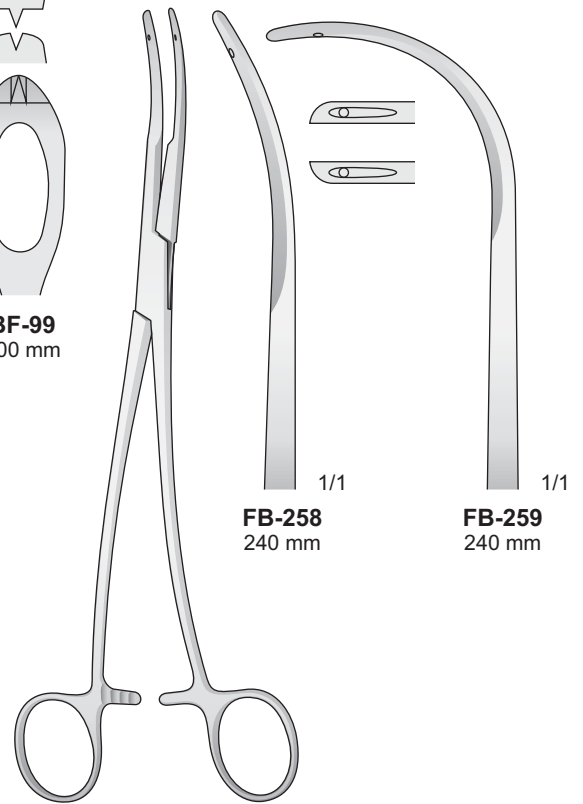

SEMB
FB-258/FB-259
240 mm

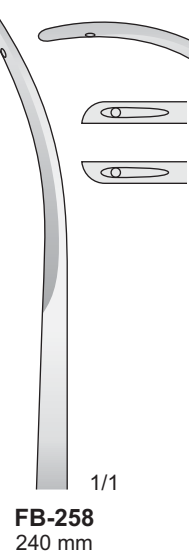

FB-258
240 mm

FB-259
240 mm

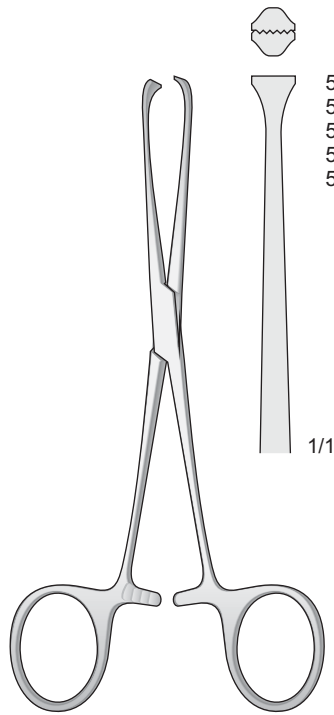

5x6 Zähne
5x6 Teeth
5x6 Denti
5x6 Dientes
5x6 Dents

BOYS-ALLIS
P-129
150 mm

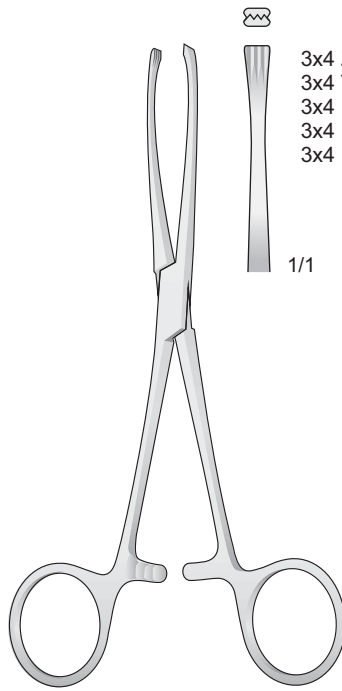

3x4 Zähne
3x4 Teeth
3x4 Denti
3x4 Dientes
3x4 Dents

JUDD-ALLIS
P-324
155 mm

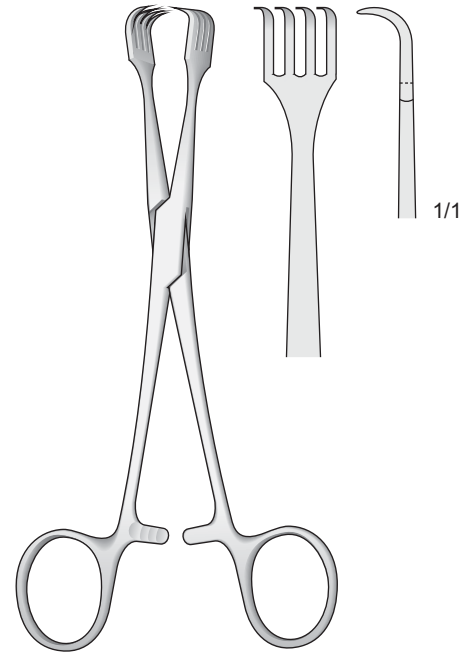

BRAUN
BF-58
155 mm



TC



Tungsten-Carbide Inserts
Mit Hartmetalleinsätzen
Plaquettes en carbure de tungstène
Plaquetas de carburo de tungsteno
Inserti in carburo di tungsteno

DUVAL
P-330
200 mm

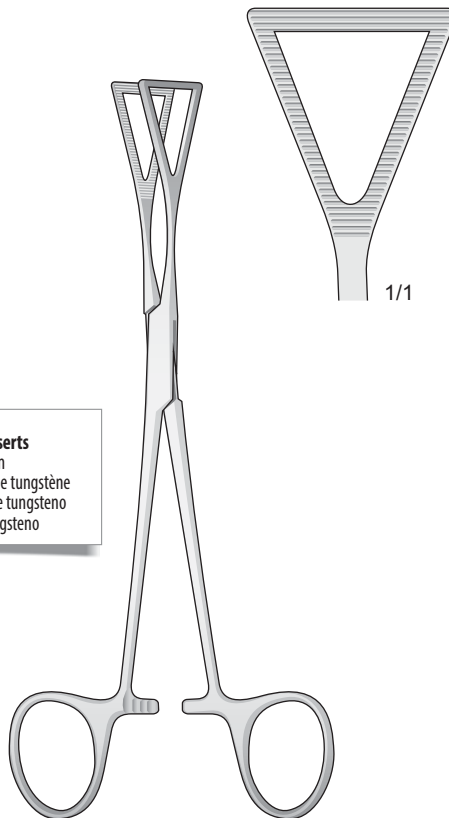

LOVELACE
P-298
200 mm

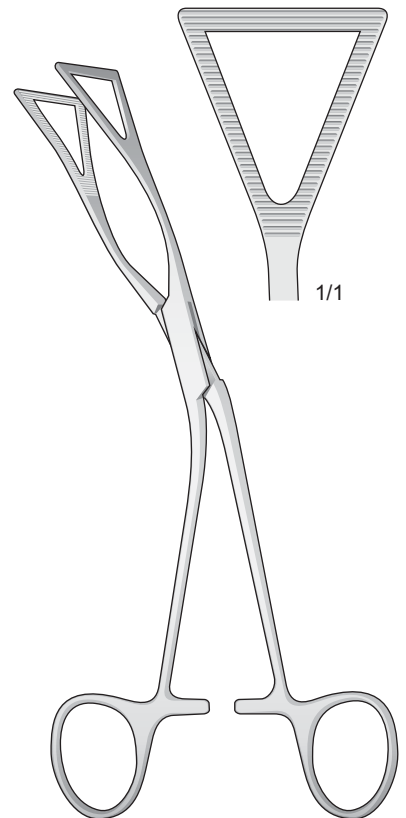

LOVELACE
P-299
200 mm

19



PEET
DR-40
120 mm

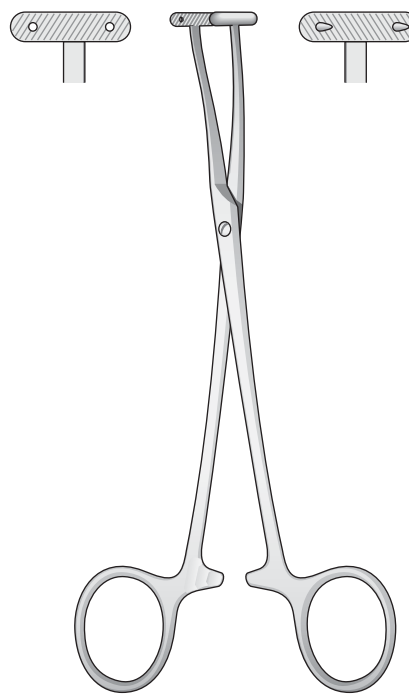

DE MARTEL
FB-120
180 mm



MIXTER
EB-33
220 mm

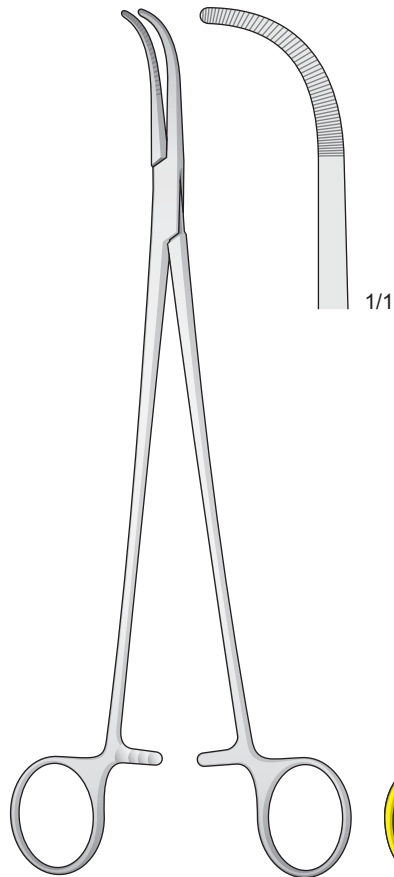

MIXTER
P-307
230 mm

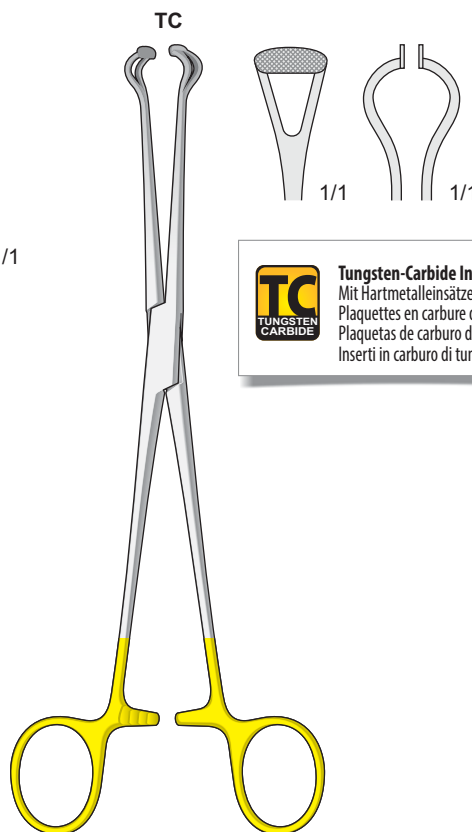

BABCOCK
P-300
210 mm

TC
TUNGSTEN
CARBIDE

Tungsten-Carbide Inserts
Mit Hartmetalleinsätzen
Plaquettes en carbure de tungstène
Plaquetas de carburo de tungsteno
Inserti in carburo di tungsteno

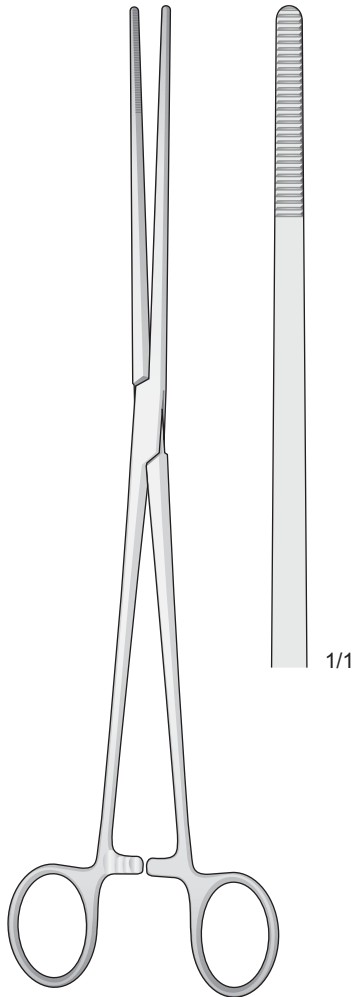

BOZEMANN
BF-112
260 mm

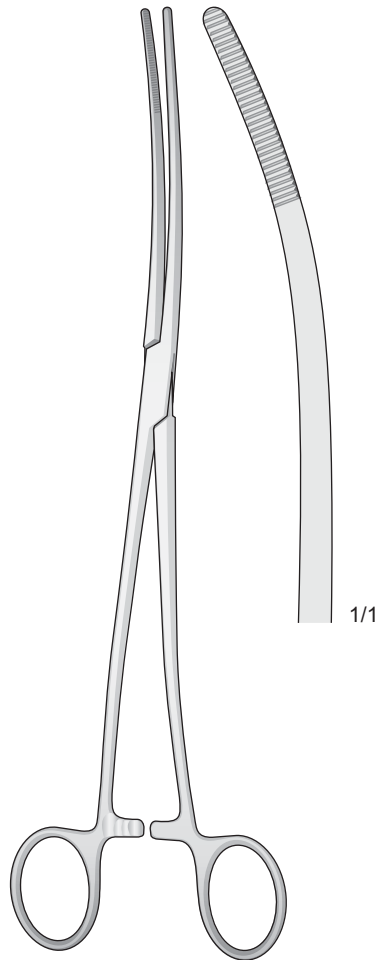

BOZEMANN
BF-113
260 mm

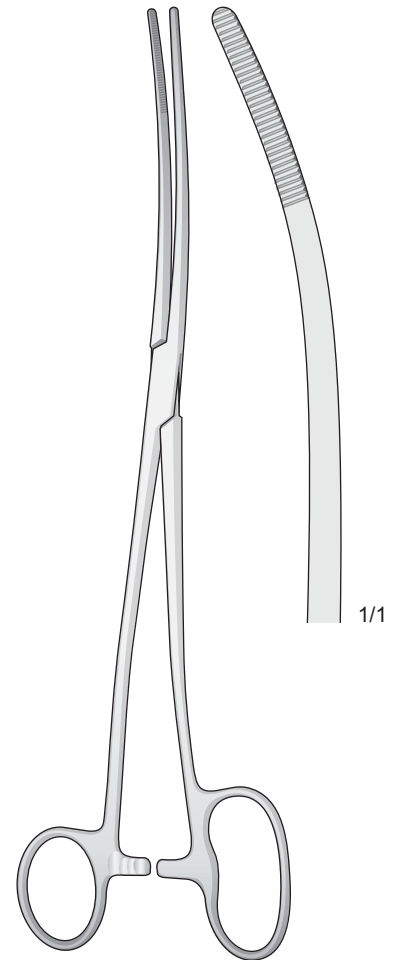

BOZEMANN-DOUGLAS
BF-114
260 mm



De BAKEY

Atraumatiche



De BAKEY

Atraumatiche

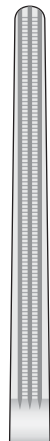

FB-223
250 mm

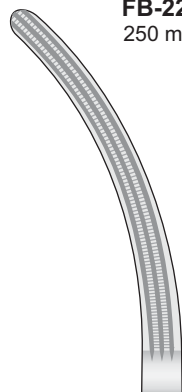

FB-224
245 mm

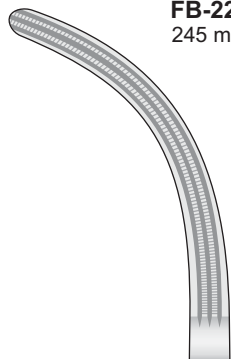

FB-225
240 mm

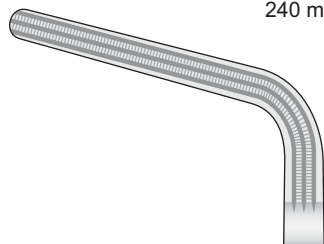

FB-226
230 mm

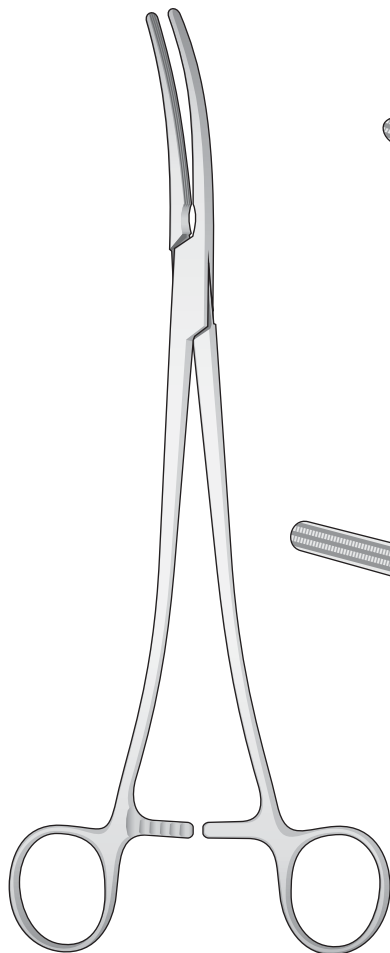

WERTHEIM
FB-223/FB-226

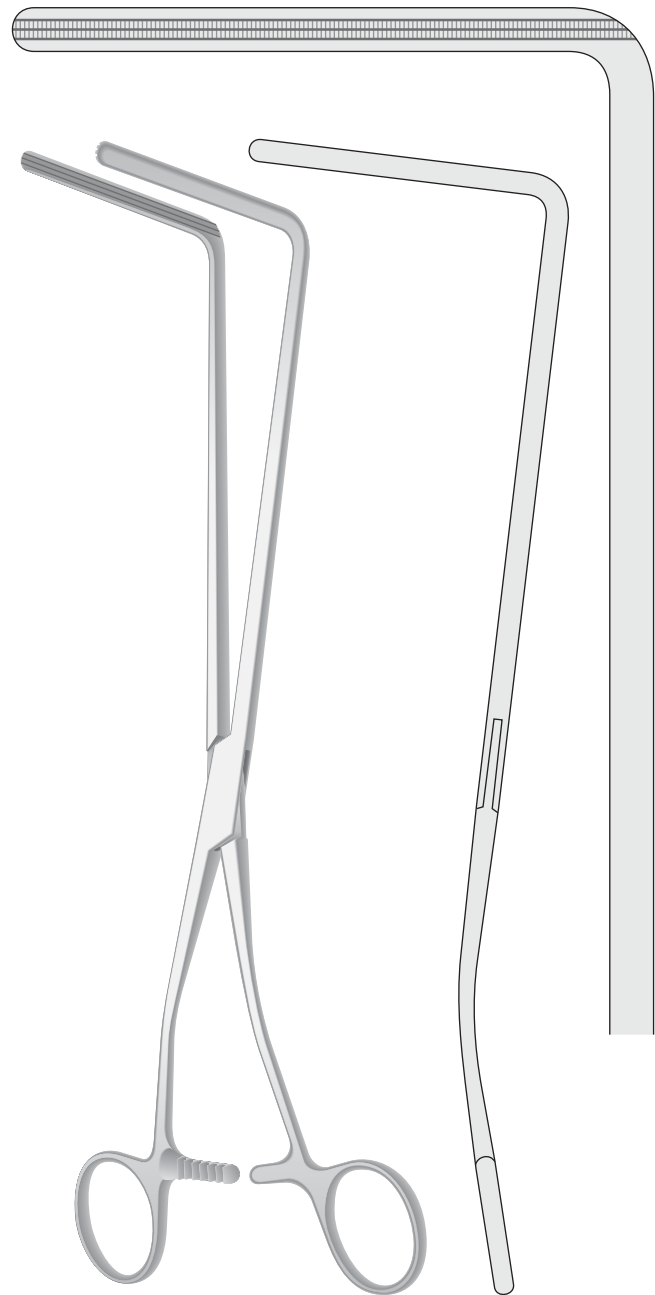

RESANO
FB-137
280 mm

1/1

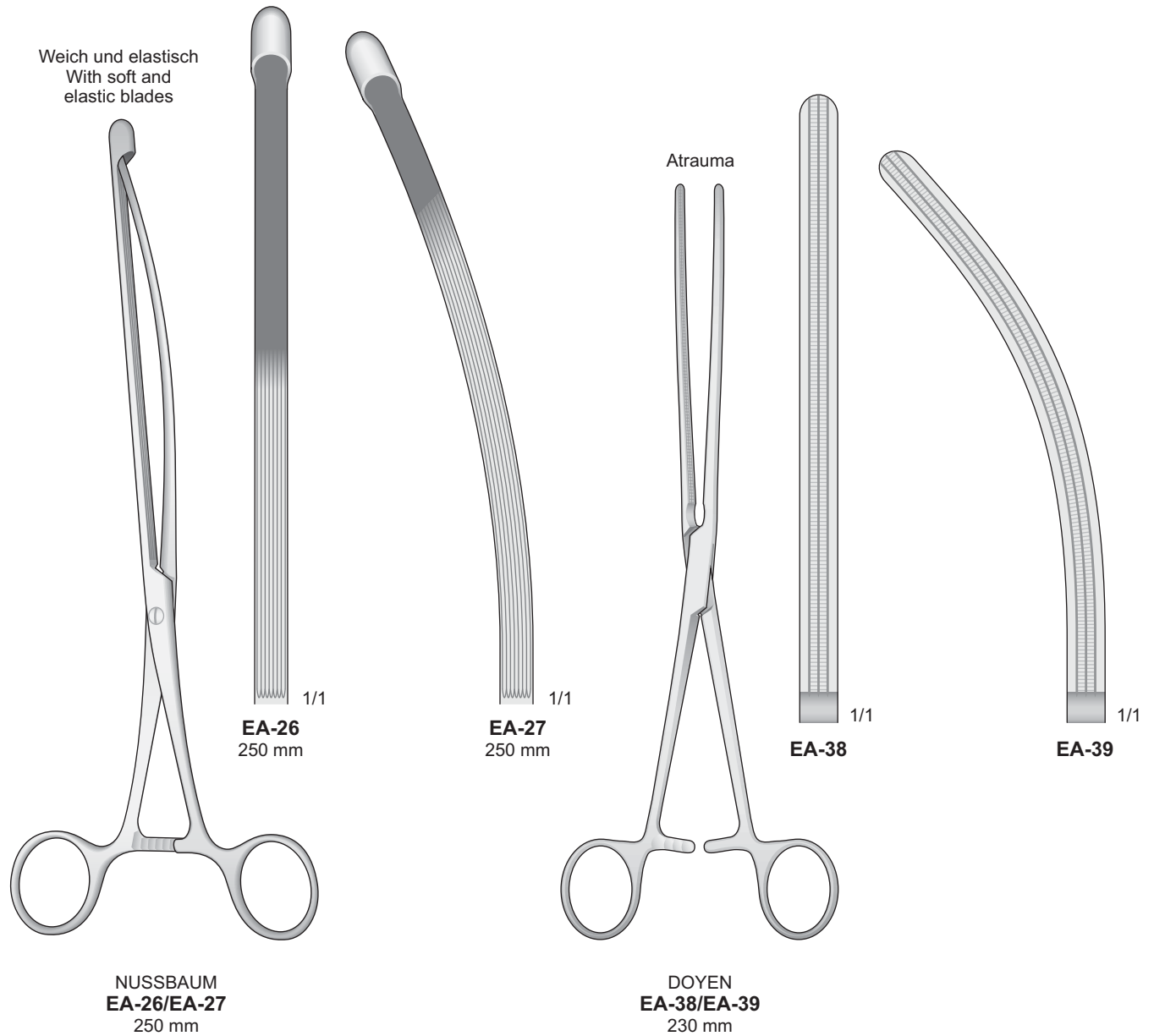

19

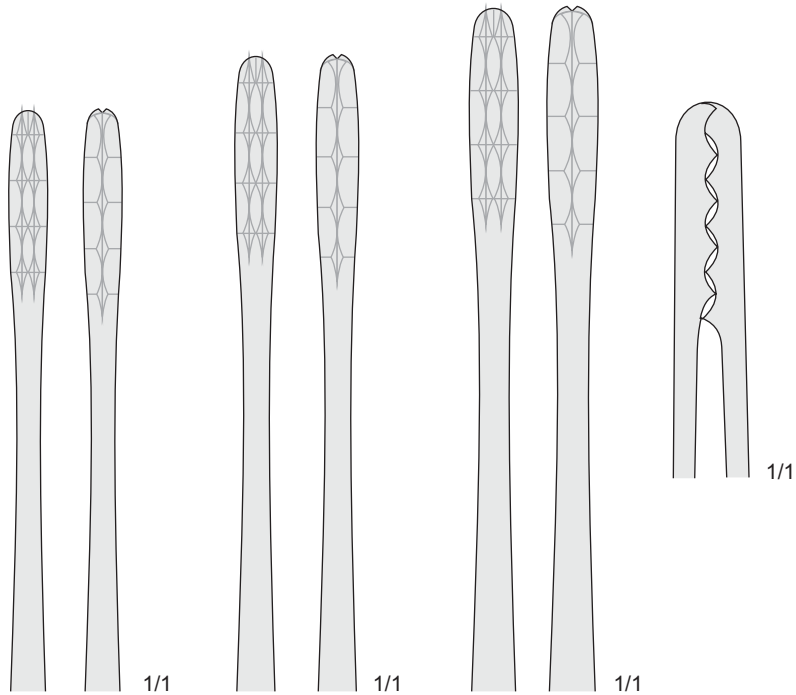

EB-270
220 mm

EB-271
250 mm

EB-272
270 mm

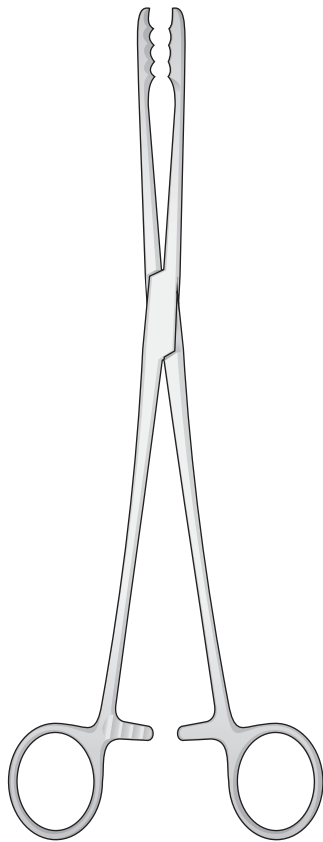

ULRICH
EB-270/EB-275

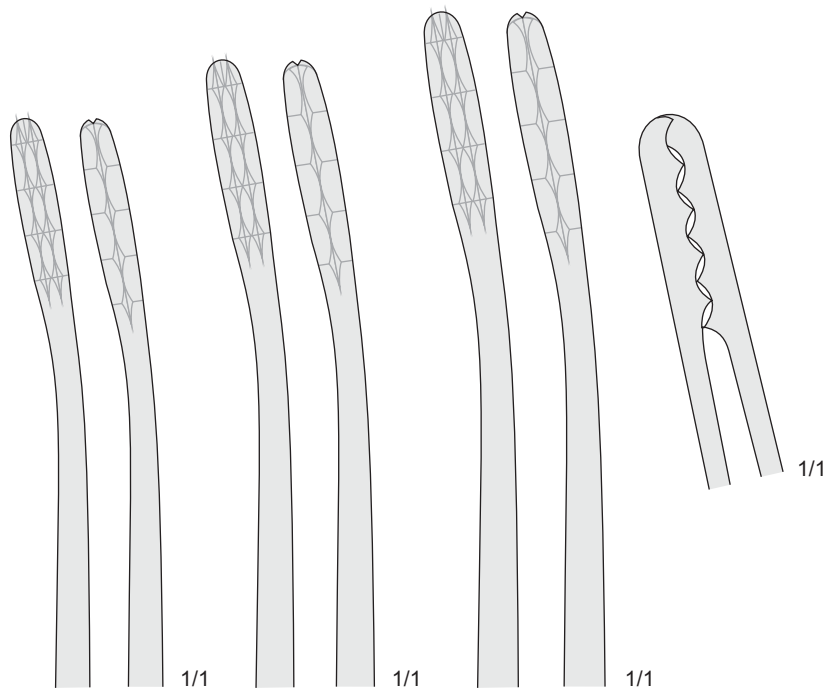

EB-273
220 mm

EB-274
250 mm

EB-275
270 mm

Titan - Titanium - Titanio - Titane

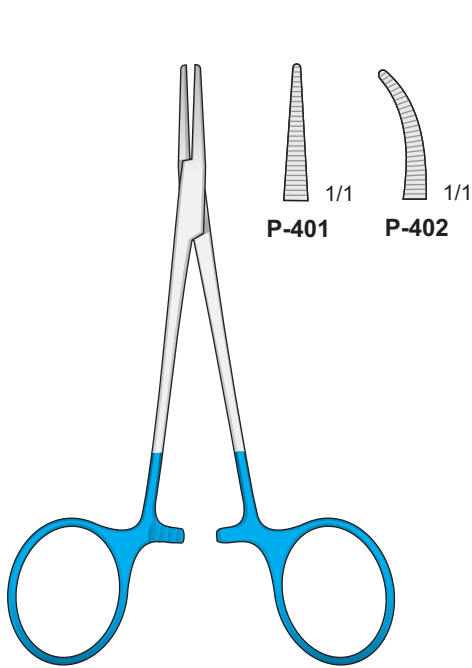

HALSTED-MOSQUITO
P-401/P-402
120 mm

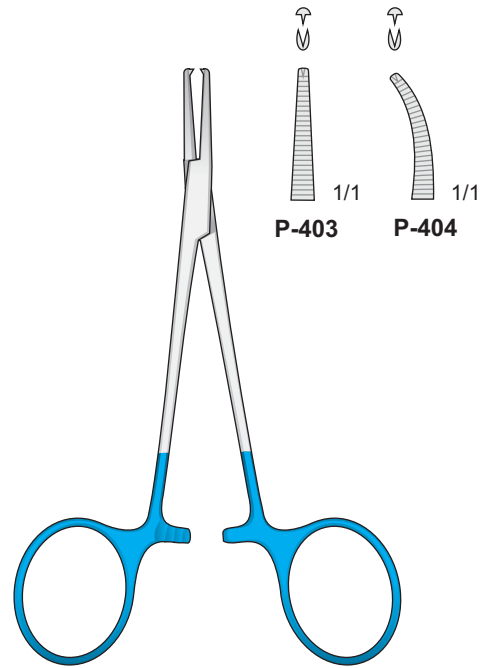

HALSTED-MOSQUITO
P-403/P-404
120 mm

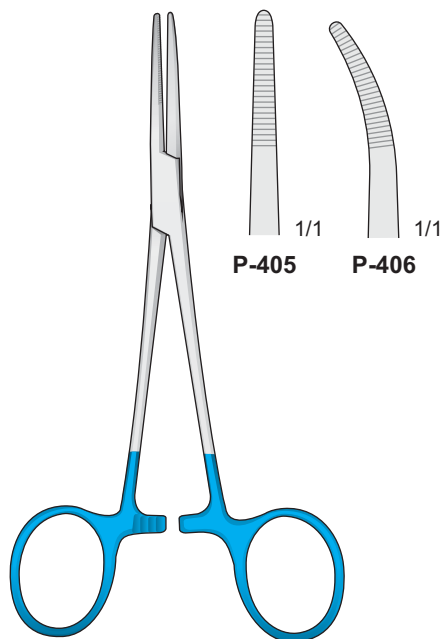

KELLY
P-405/P-406
140 mm

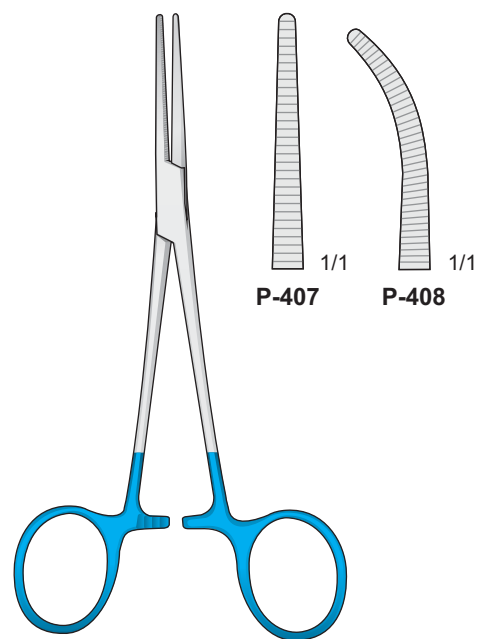

CRILE
P-407/P-408
140 mm

FB-390
Krampfaderbesteck komplett
Varicose Vein Probe Set complete
Set completo sonda per varici
Juego para varices completo
Trousse à varices complète

Metall-Sondenspitzen
Probe tip, metal
Punta per sonda
in metallo
Punta metálica
Pointe en métal

Ø 3 mm

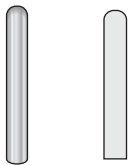

FB-394



FB-395/FB-398

Oliven - Olives - Olive - Oliva - Olive



Ø 6 mm

FB-395



Ø 9 mm

FB-396



Ø 12 mm

FB-397



Ø 15 mm

FB-398

Griff Allein
Handle only
Manico solo
Mango solo
Manche seule

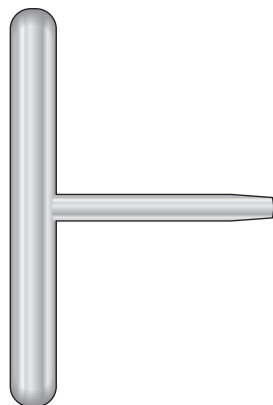

FB-400

Zugseil
Traction Cable
Cavo per trazione
Cable de tracción
Cable tracteur

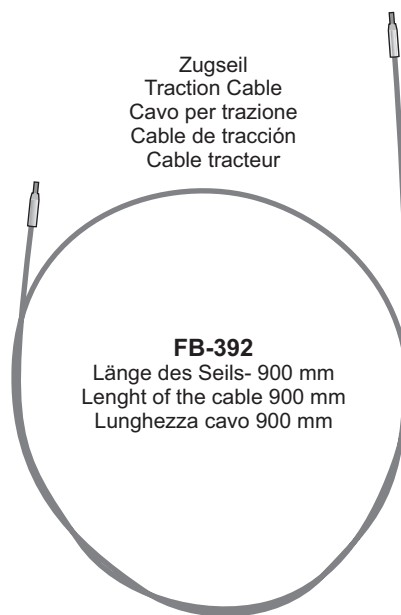

FB-392
Länge des Seils- 900 mm
Lenght of the cable 900 mm
Lunghezza cavo 900 mm

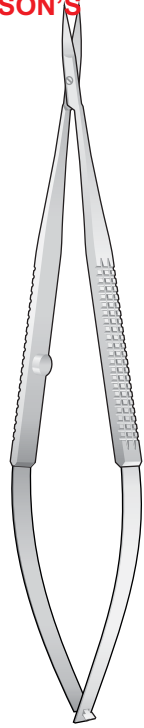

FD-182/FD-183
160 mm

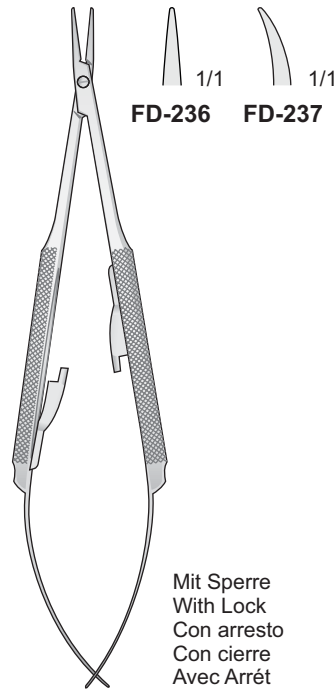
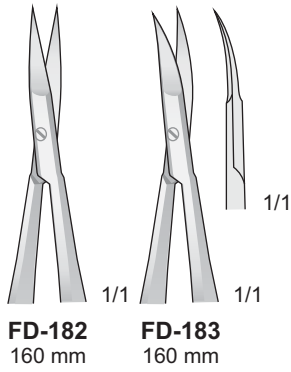

BARRAQUER
FD-236/FD-237
150 mm

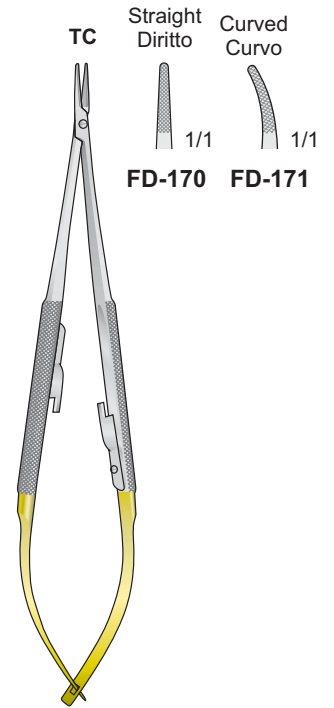

CASTROVIEJO
FD-170/FD-171
140 mm

Nadelhalter mit Hartmetalleinlagen - Needle Holders with tungsten-carbide inserts
Portaghi con inserti al tungsteno - Portaagujas con plaquetas de carburo de tungsteno
Porte aiguilles avec plaquettes en carbure de tungstène

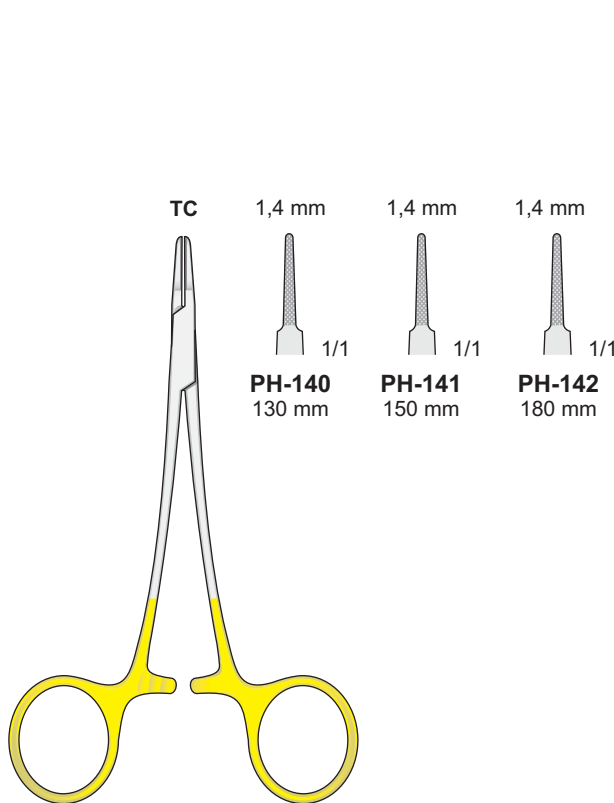

MICRO-RYDER
PH-140/PH-142

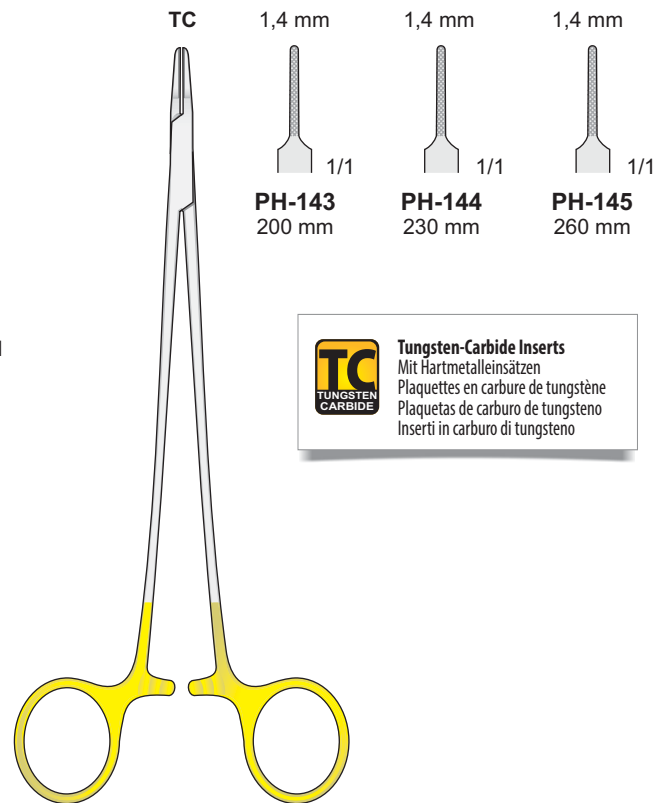

MICRO-RYDER
PH-143/PH-145

TC
TUNGSTEN CARBIDE

Tungsten-Carbide Inserts
Mit Hartmetalleinsätzen
Plaquettes en carbure de tungstène
Plaquetas de carburo de tungsteno
Inserti in carburo di tungsteno

19



Nadelhalter mit Hartmetalleinlagen - Needle Holders with tungsten-carbide inserts - Portaghi con inserti al tungsteno
 Portaagujas con plaquitas de carburo de tungsteno - Porte aiguilles avec plaquettes en carbure de tungstène

Ein Ring abgewinkelt
 One ring angled
 Un anello angolato

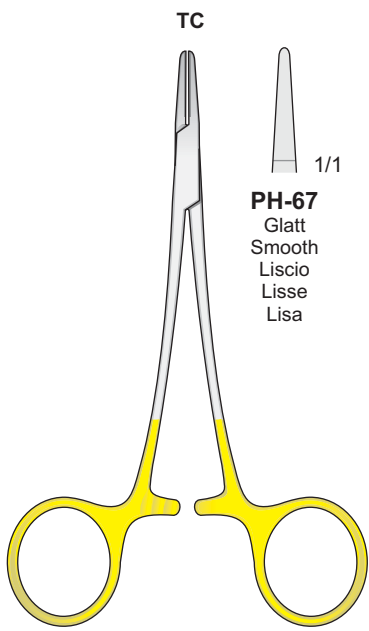

**HALSEY
 PH-67**
 130 mm

PH-67
 Glatt
 Smooth
 Liscio
 Lisse
 Lisa

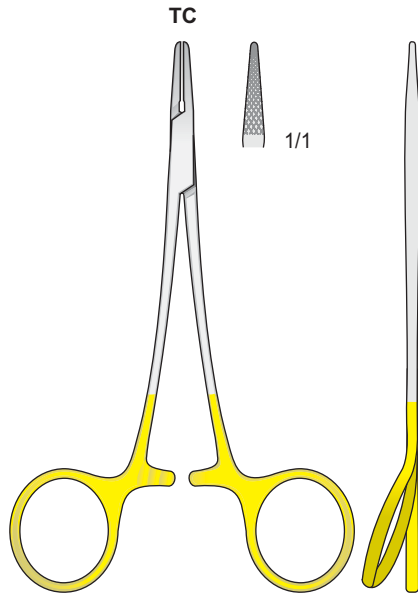

PH-99
 120 mm

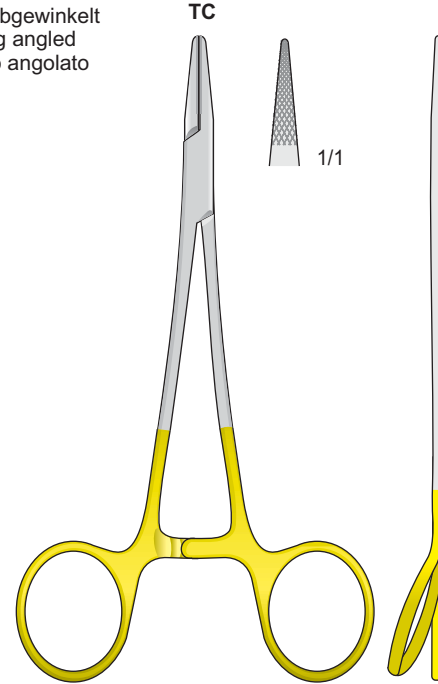

**CRILE-WOOD
 PH-100**
 150 mm

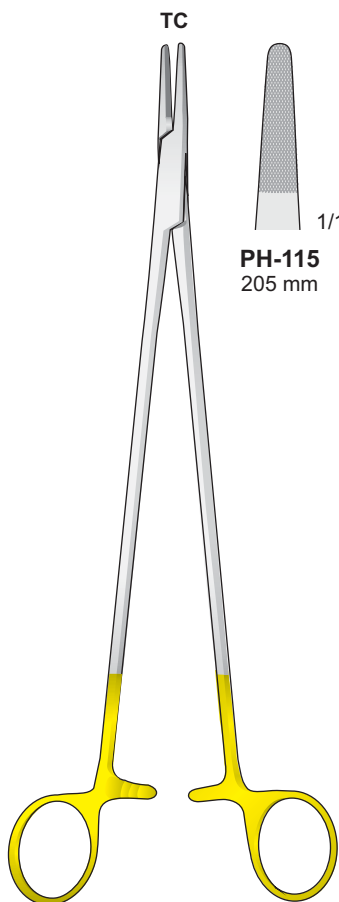

**HEGAR
 PH-115/PH-116**

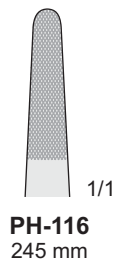

PH-115
 205 mm

PH-116
 245 mm



**DE BAKKEY
 PH-135**
 370 mm

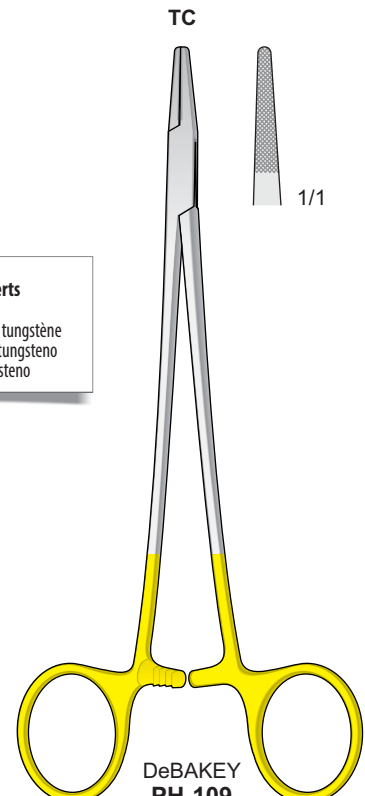

**DeBAKEY
 PH-109**
 200 mm

Tungsten-Carbide Inserts
 Mit Hartmetalleinsätzen
 Plaquettes en carbure de tungstène
 Plaquetas de carburo de tungsteno
 Inserti in carburo di tungsteno

Für Linkshänder - Left Handed
Per mancini - Pour gauche - Para zurdos

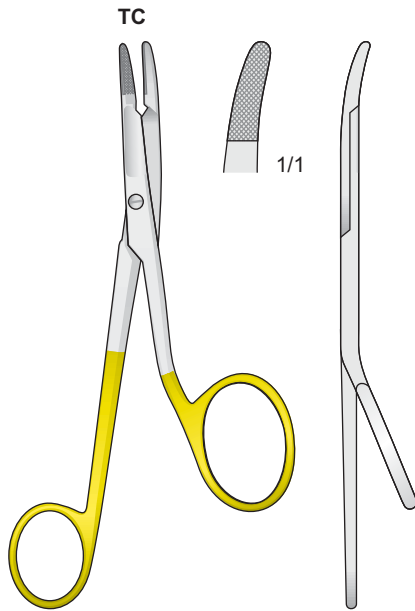

**GILLIES
PO-97L**
160 mm

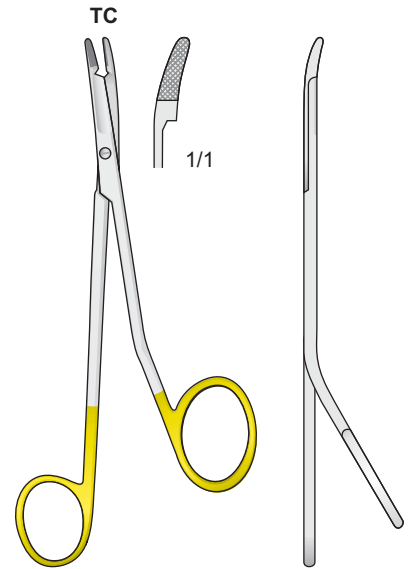

**MINI-GILLIES
PO-99L**
145 mm

TC
TUNGSTEN
CARBIDE
Tungsten-Carbide Inserts
Mit Hartmetalleinsätzen
Plaquettes en carbure de tungstène
Plaquetas de carburo de tungsteno
Inserti in carburo di tungsteno

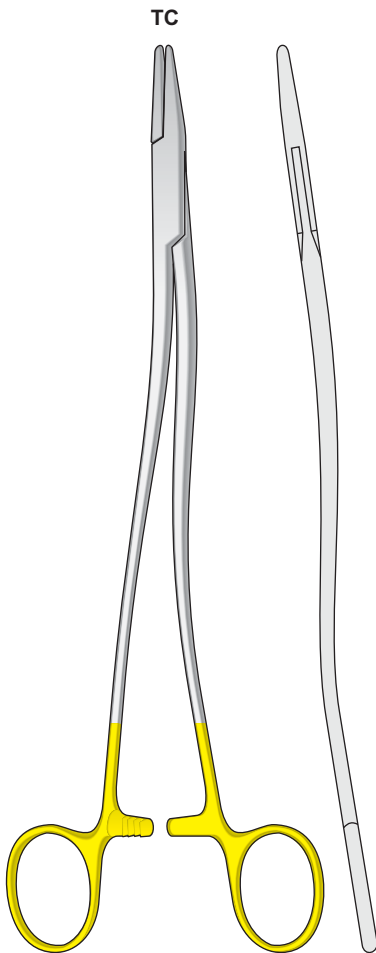

**BOZEMANN
PH-136/139**

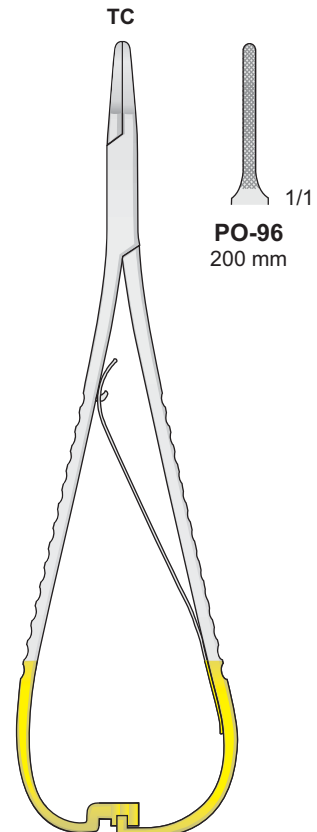
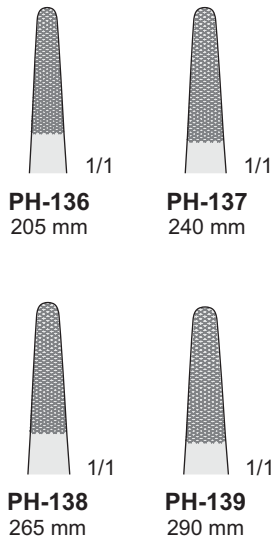

**LICHTENBERG
PO-96**
175 mm

Kräftiges Modell
Heavy pattern
Modello robusto
Modèle robuste

TC

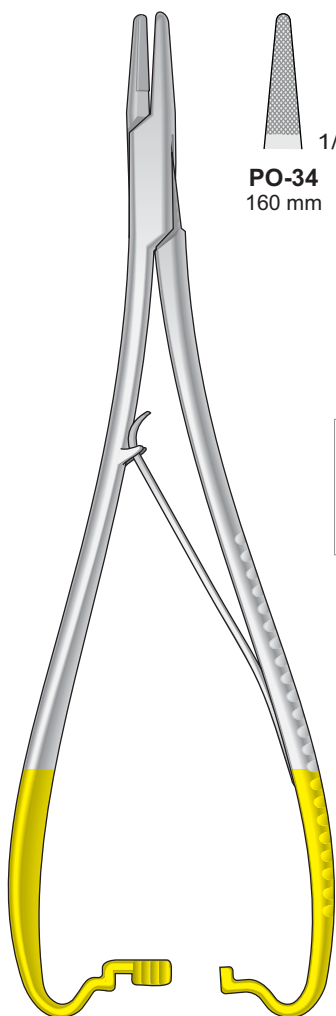

MATHIEU
PO-34/PO-36

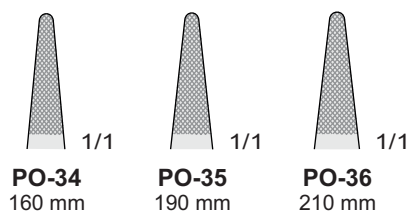

TC
TUNGSTEN
CARBIDE
Tungsten-Carbide Inserts
Mit Hartmetalleinsätzen
Plaquettes en carbure de tungstène
Plaquetas de carburo de tungsteno
Inserti in carburo di tungsteno

Atraumatische - Atraumatic
Atraumatiche - Atraumáticas
Atraumatique

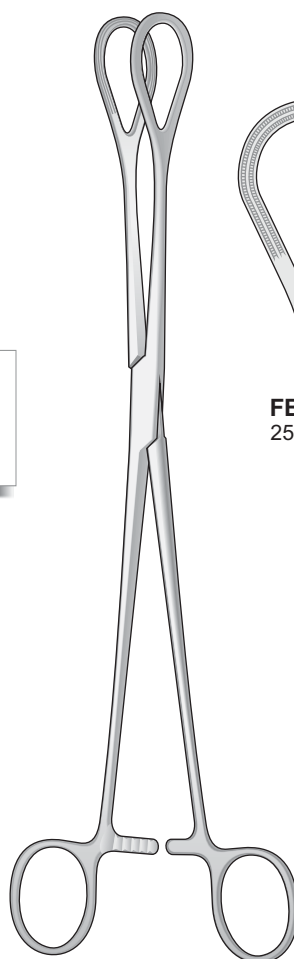

FB-115/FB-116

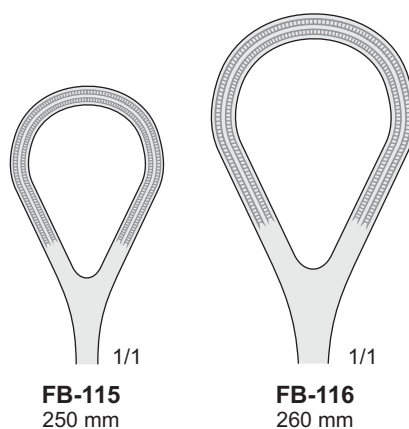

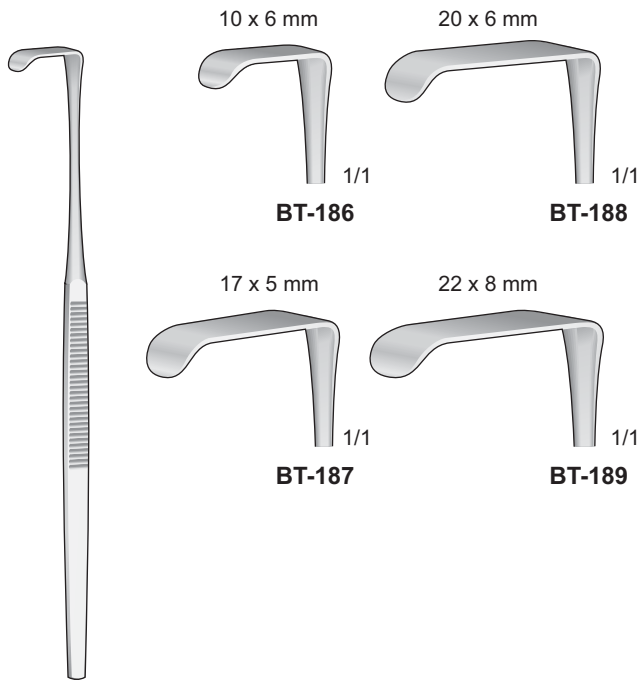

MINI-LANGENBECK
BT-186/BT-189
160 mm

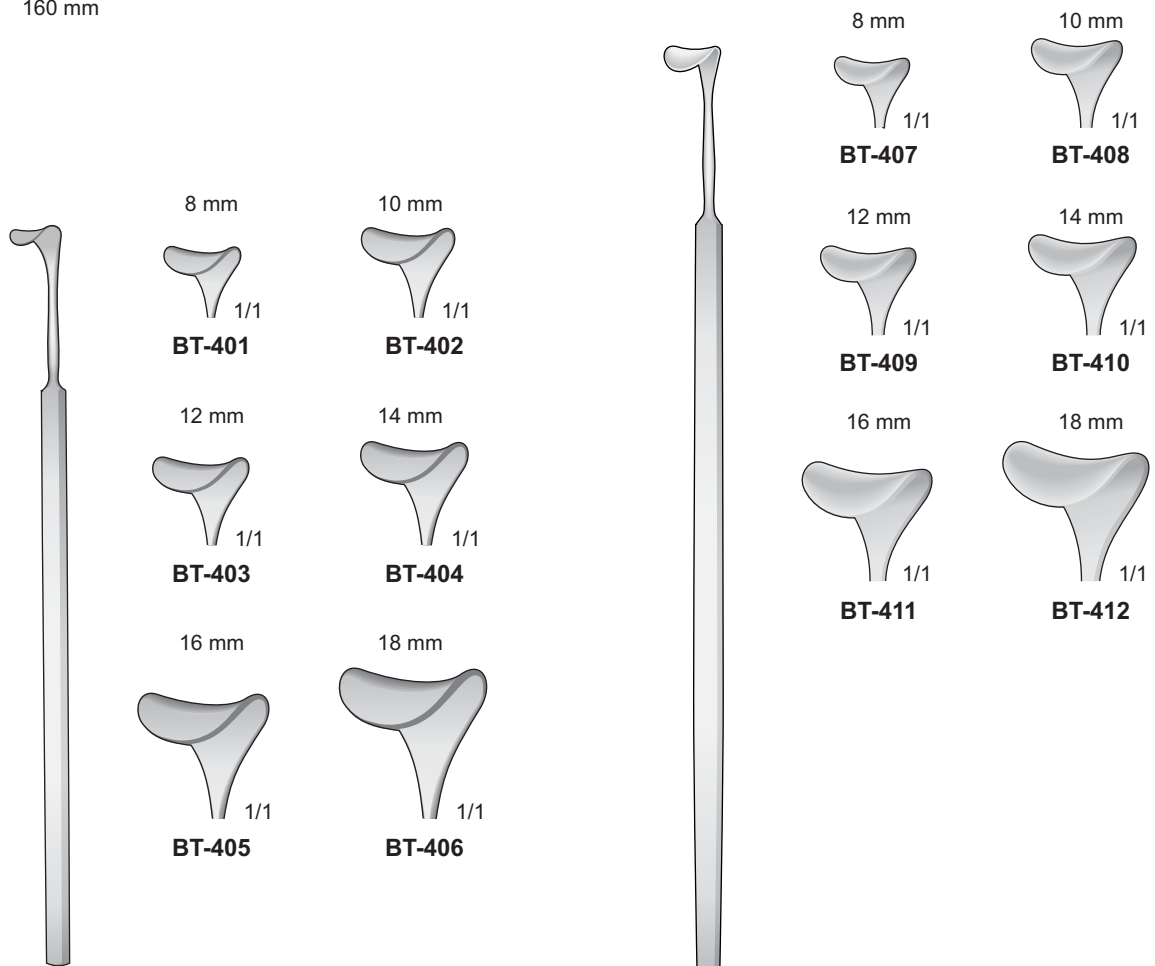

CUSHING
BT-401/BT-406
200 mm

CUSHING
DS-407/DS-412
240 mm

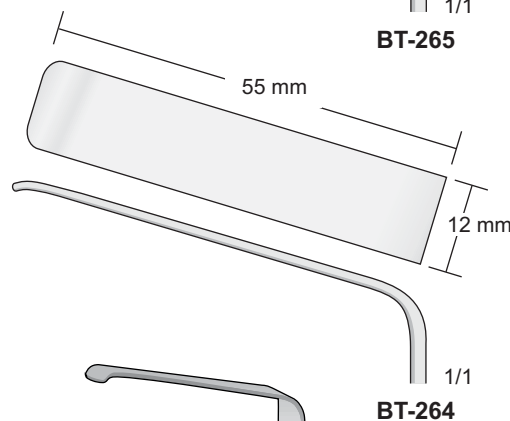
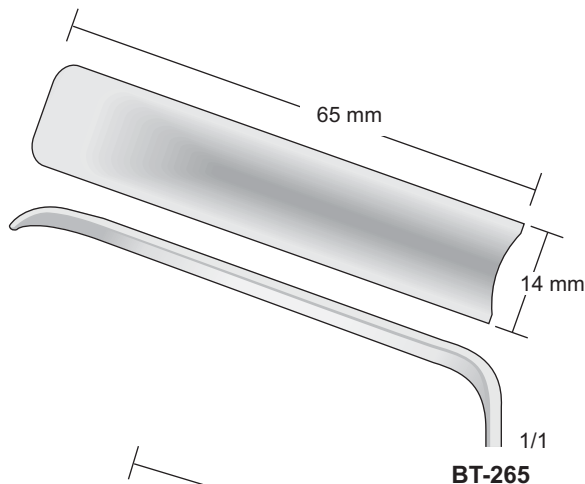

KOCHER
BT-270/BT-272
250 mm

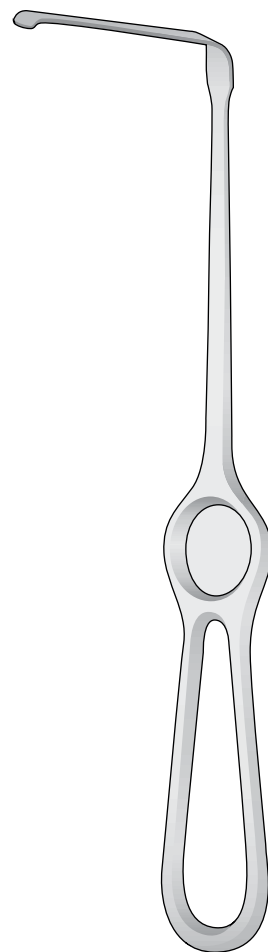

BT-264/BT-265
235 mm

190x38 mm
190x57 mm

160x38 mm
160x57 mm

1/1

1/1

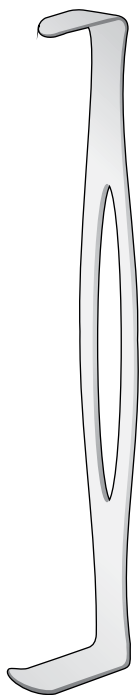

BT-292
21 x 24 mm
40 x 15 mm

PARKER-LANGENBECK
BT-292
210 mm

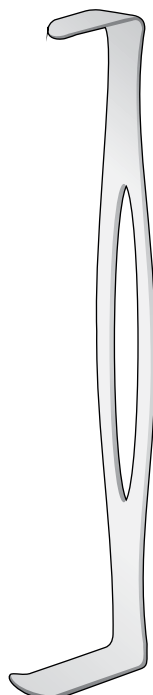

BT-293
25 x 24 mm
45 x 15 mm

PARKER-LANGENBECK
BT-293
210 mm



BT-337 160x38 mm
BT-338 160x57 mm
BT-339 190x38 mm
BT-340 190x57 mm

KELLY
BT-337/BT-340
270 mm

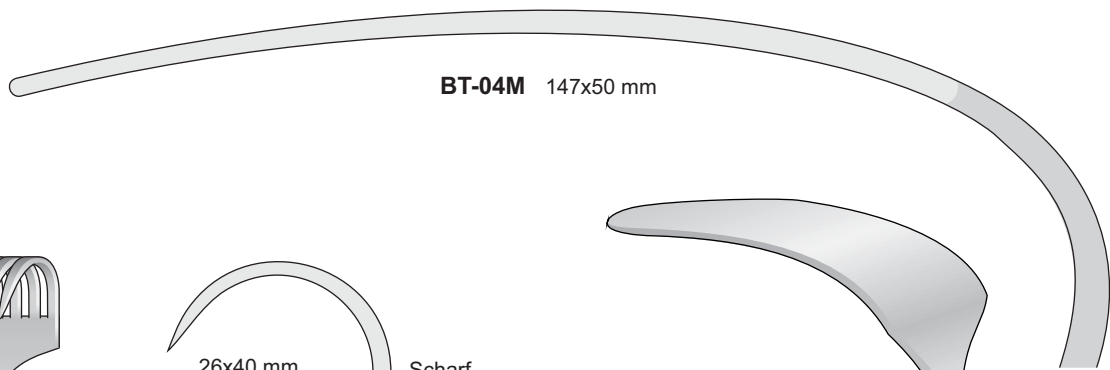
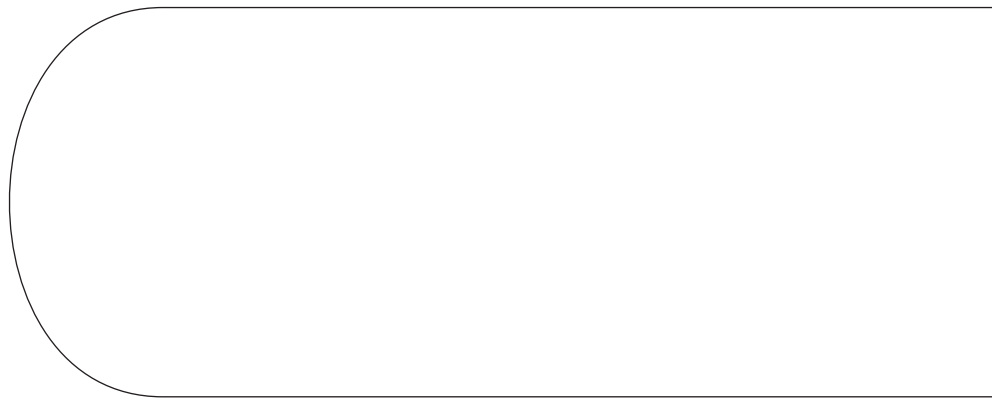

BT-04M 147x50 mm

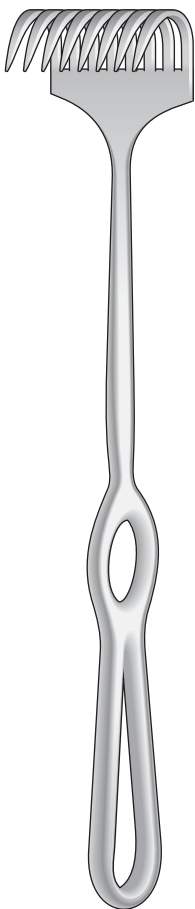

KÖRTE
BT-323/BT-324
240 mm

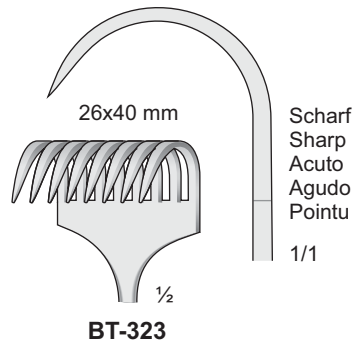

BT-323

Scharf
Sharp
Acuto
Agudo
Pointu
1/1

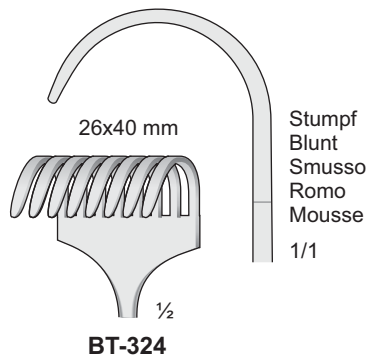

BT-324

Stumpf
Blunt
Smusso
Romo
Mousse
1/1

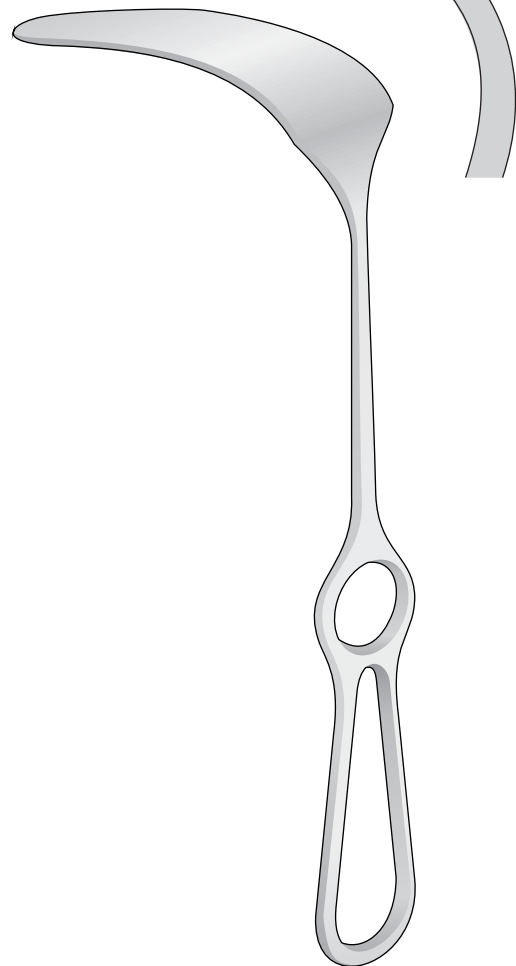

MIKULICZ
BT-04M
260 mm

1/1

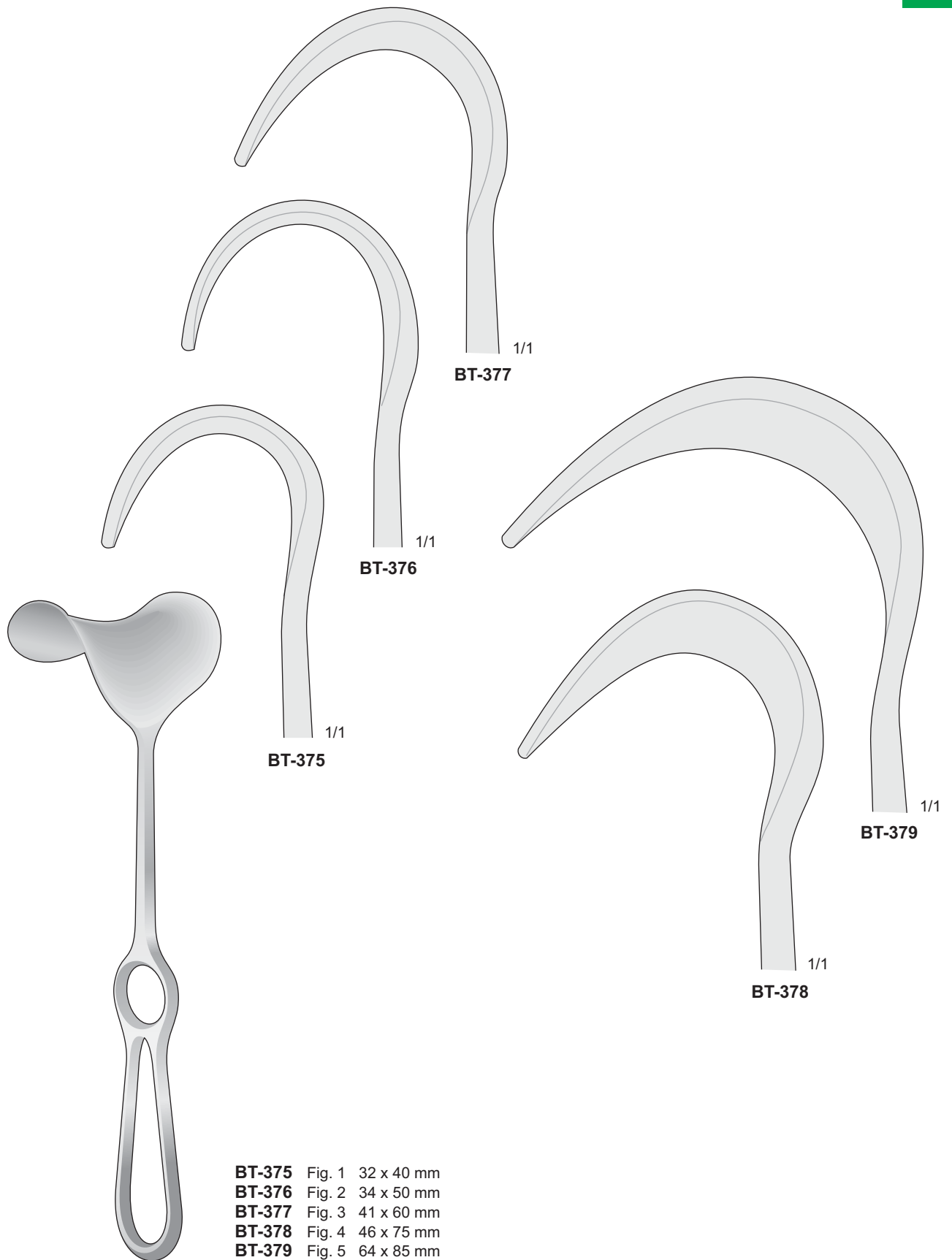

FRITSCH
BT-375/BT-379
 240 mm

Pelvishaken
Pelvis retractors

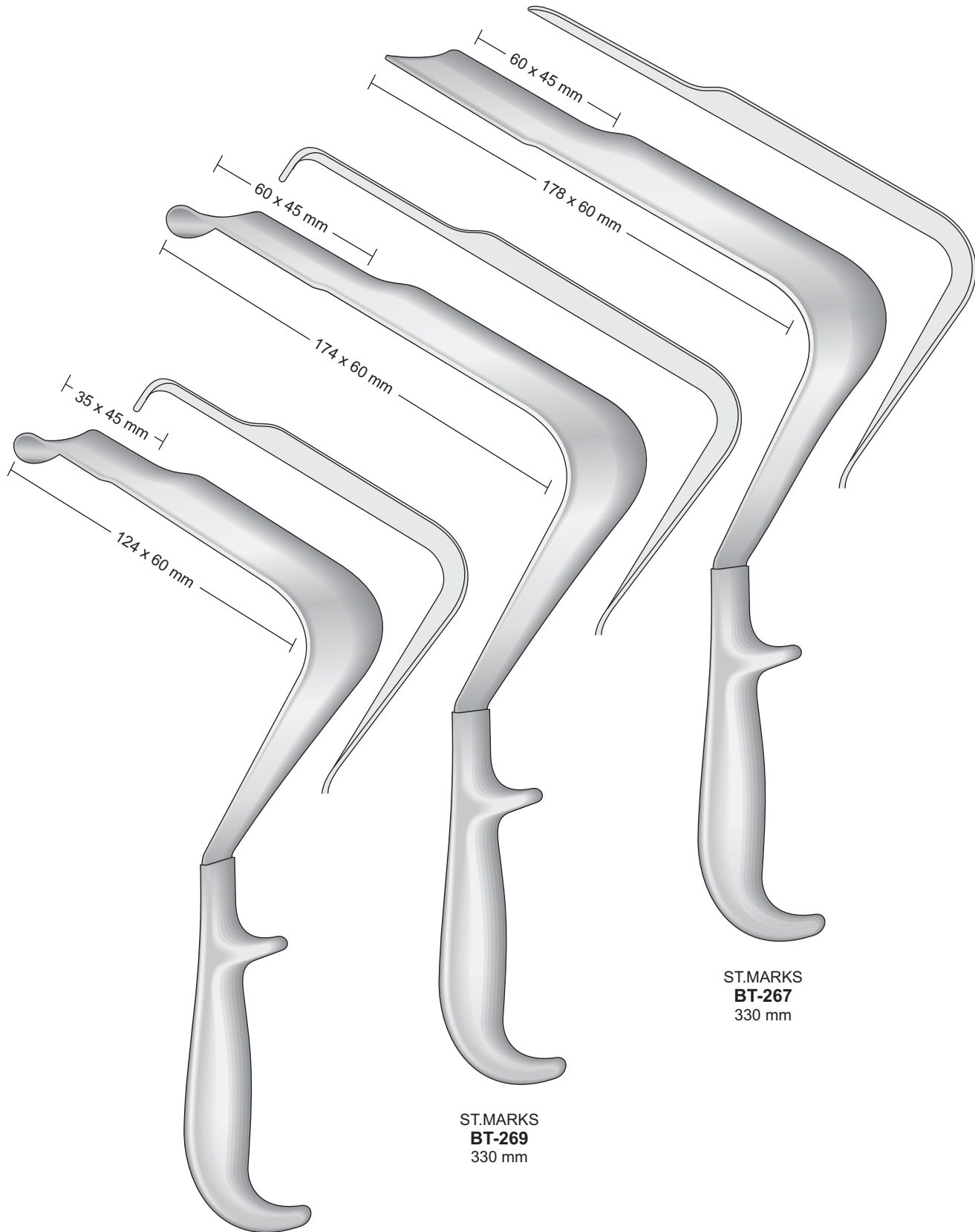

ST.MARKS
BT-267
330 mm

ST.MARKS
BT-269
330 mm

ST.MARKS
BT-268
290 mm

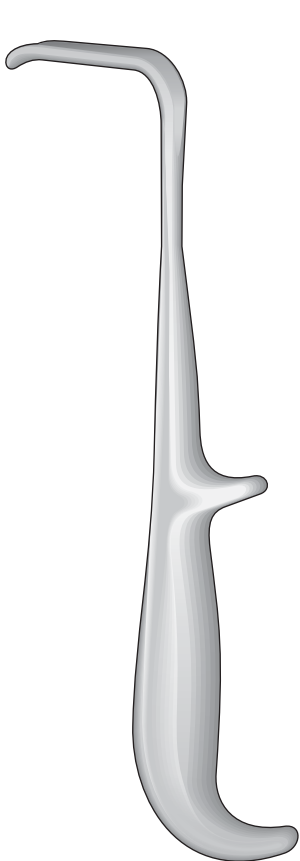
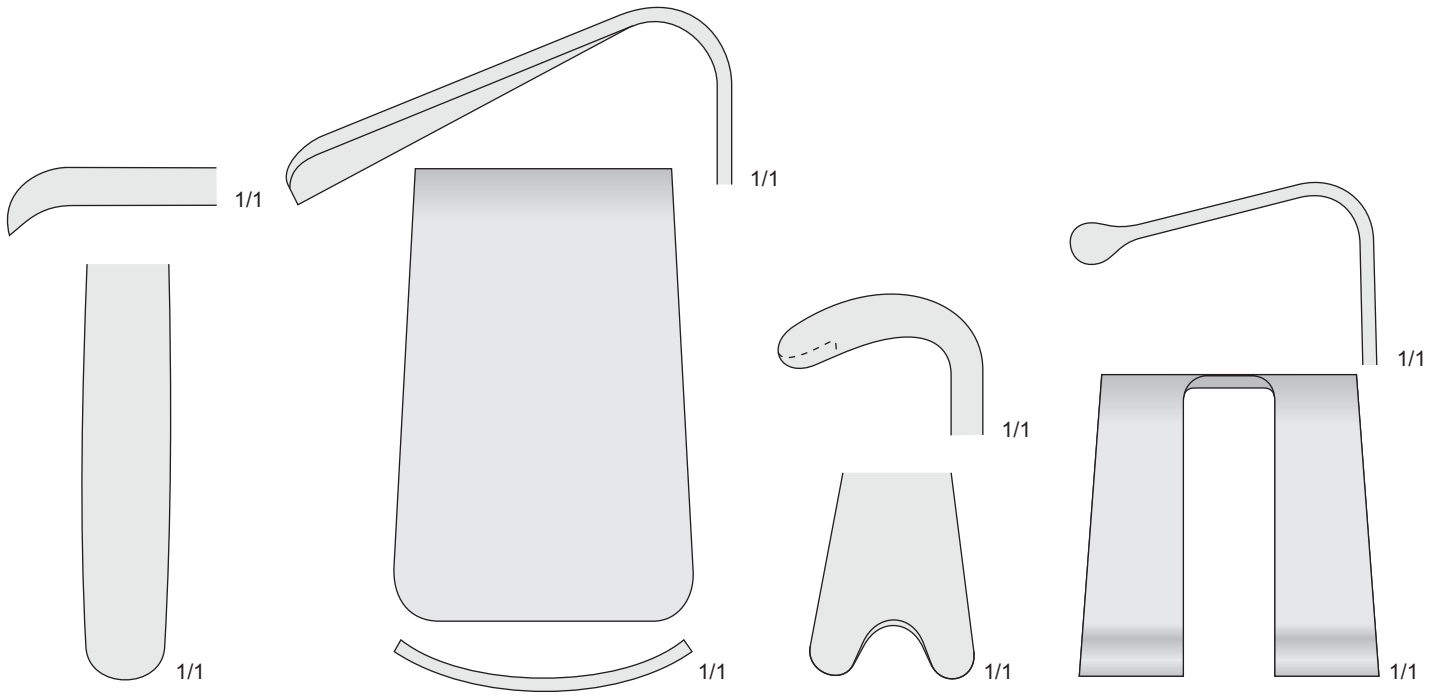

YOUNG
BT-366
215 mm

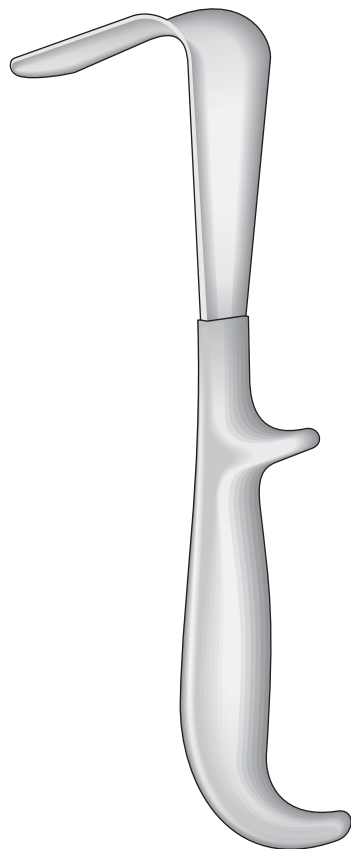

YOUNG
BT-367
210 mm

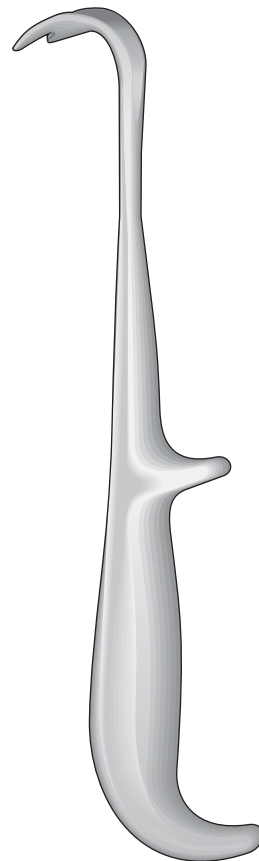

YOUNG
BT-368
220 mm

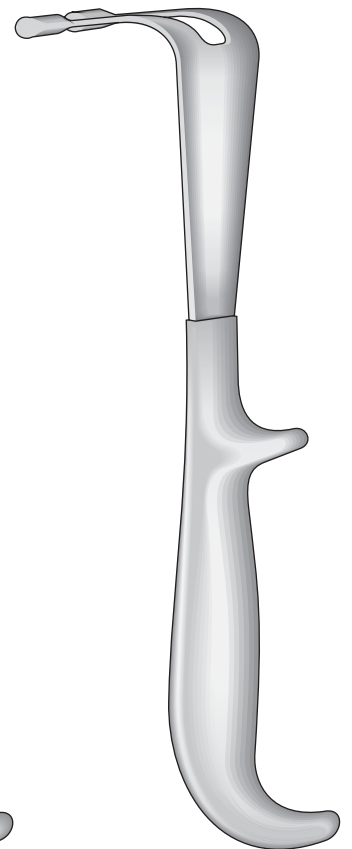

YOUNG
BT-369
210 mm

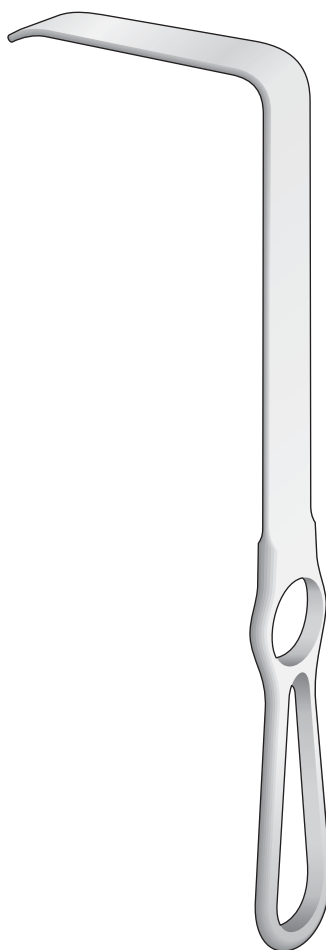
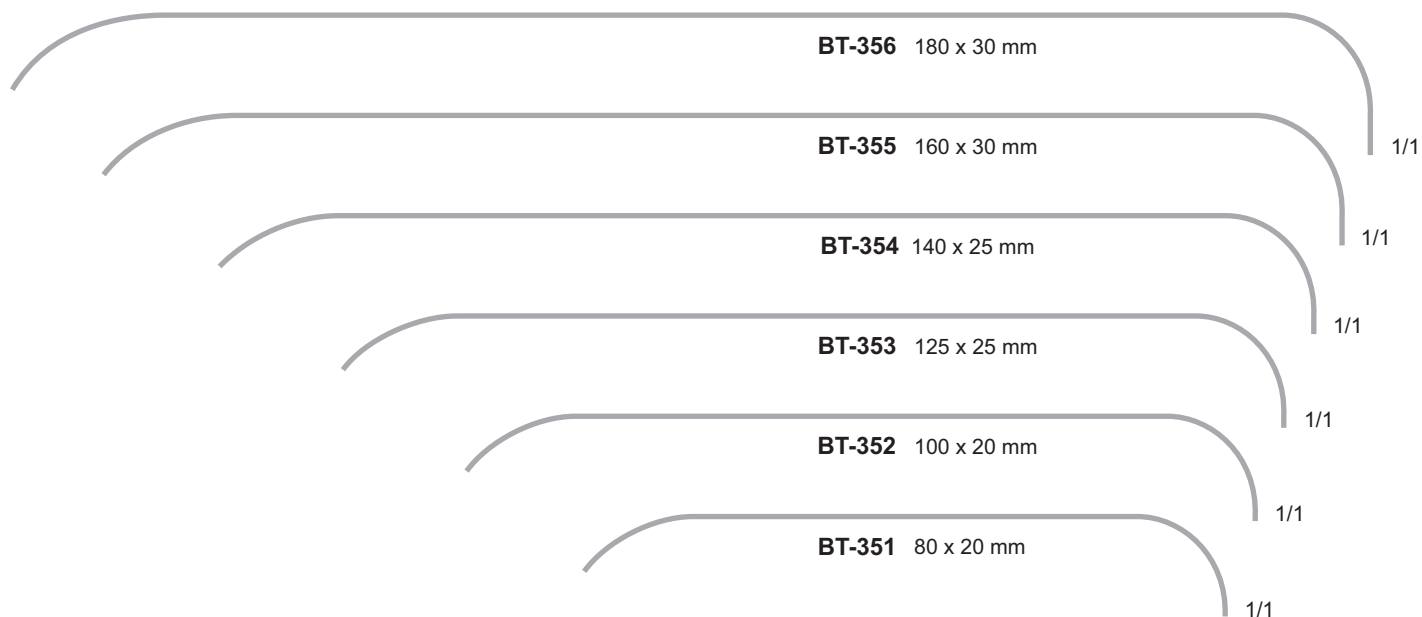

BRUNNER
BT-351/BT-356
250 mm

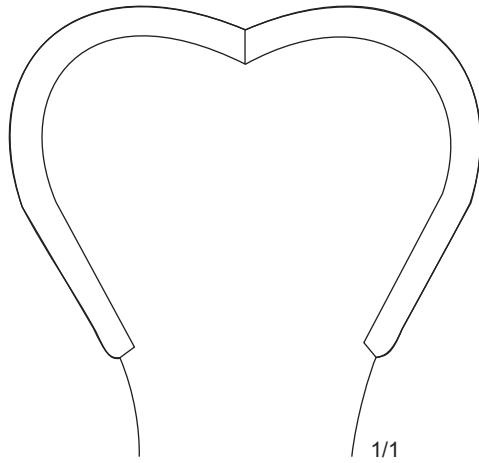

HARRINGTON-PEMBERTON
BT-343 175 x 64 mm
295 mm

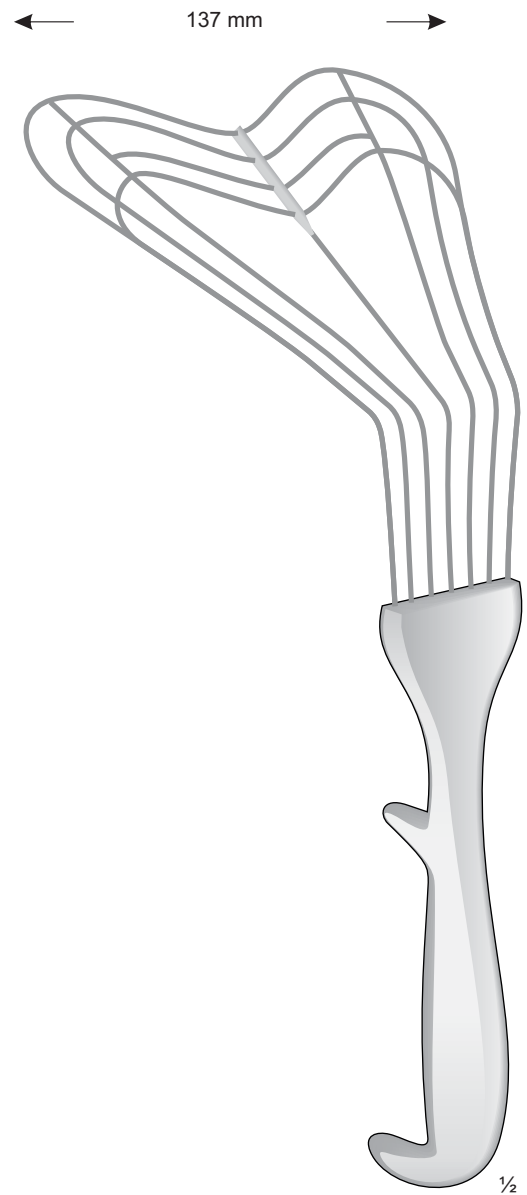

BT-346
300 mm

Gefäßclips - Vessel Clips
Clamps vascolari - Clamps vasculares
Clamps vasculaires

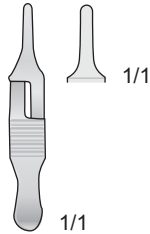

DIEFFENBACH
BM-96
30 mm

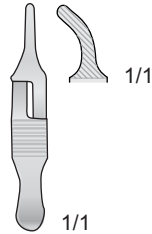

DIEFFENBACH
BM-97
30 mm

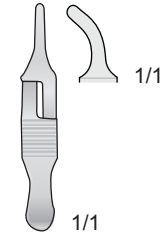

DIEFFENBACH
BM-98
30 mm

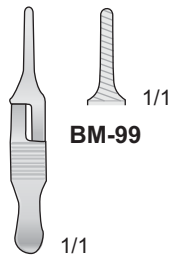

DIEFFENBACH
BM-99
30 mm

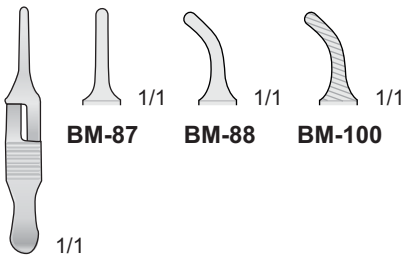

DIEFFENBACH
BM-87/BM-100
35 mm

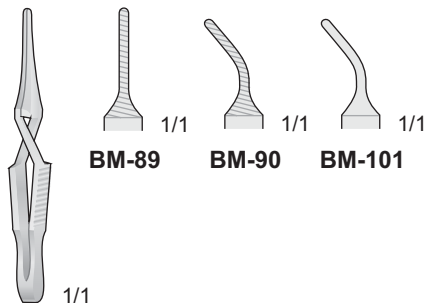

BM-89/BM-101
40 mm

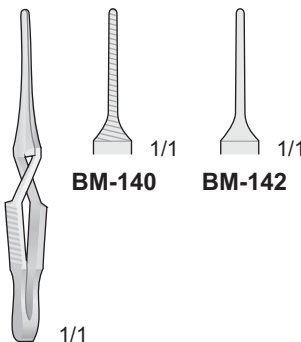

BM-140/BM-142
45 mm

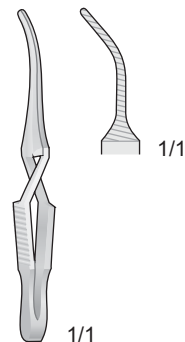

BM-141
45 mm



ES-150

Komplettsset mit 3 Haken Stripper - Set complete with 3 Vein Stripper
 Set completo con 3 uncini per vene - Set completo con 3 sondas para verices
 Set complete avec 3 stripper a anneau

Fig. 1



ES-151
140 mm

Fig. 2

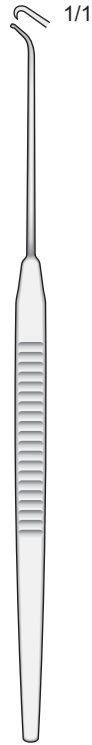

ES-152
140 mm

Fig. 3

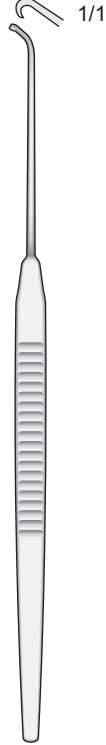

ES-153
140 mm

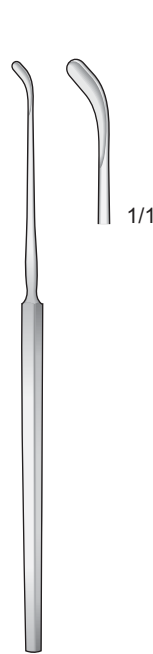

ZAUFAL
DB-27 160 mm
DB-28 200 mm

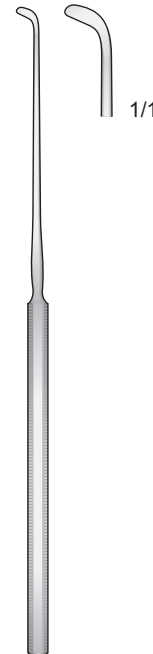

JANSEN-NEWHART
DB-40
170 mm

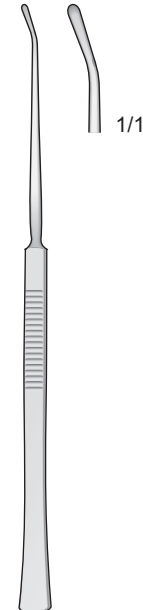

YANKAUER
DB-41
160 mm

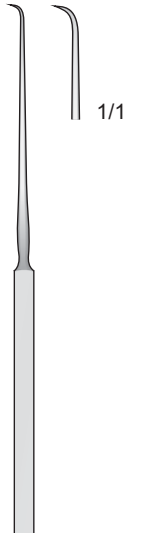

WAGENER
DB-47
140 mm

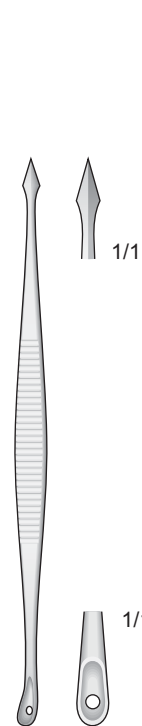

SAALFELD
DS-26
100 mm

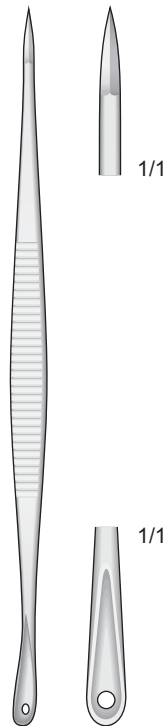

SAALFELD
DS-27
140 mm

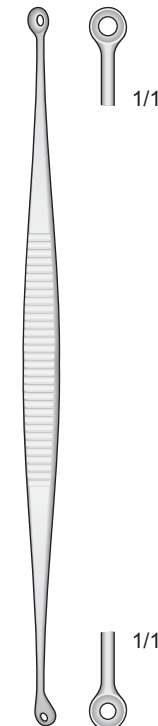

UNNA
DS-28
140 mm

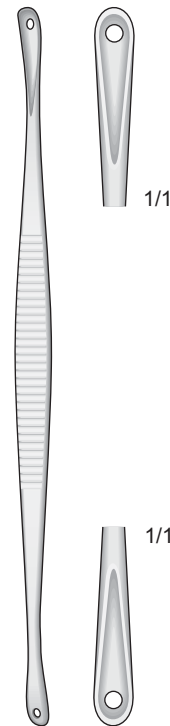

UNNA
DS-29
140 mm

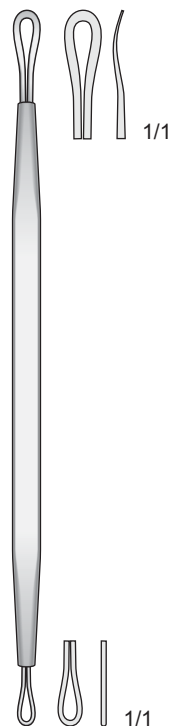

ES-22
130 mm

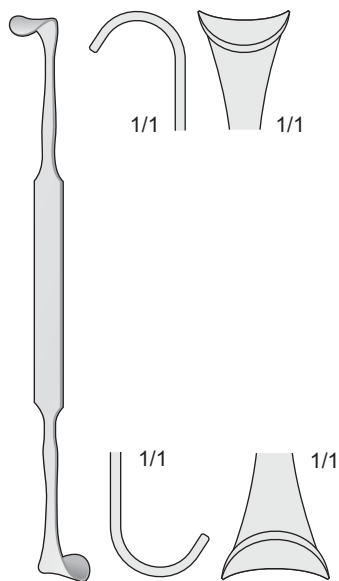

ROSE
DS-15
130 mm

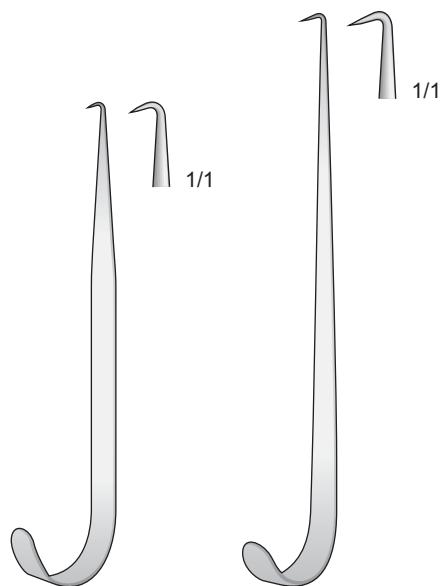

JACKSON
DS-17
130 mm

JACKSON
DS-18
150 mm

Links
Left
Sinistra
Izquierda
Gauche



BOSE
DS-10
160 mm

Rechts
Right
Dextra
Derecha
Droit



BOSE
DS-11
160 mm

Links
Left
Sinistra
Izquierda
Gauche



BOSE
DS-12
160 mm

Rechts
Right
Dextra
Derecha
Droit



BOSE
DS-13
160 mm

Scharf
Sharp
Acuto
Agudo
Pointu

Stumpf
Blunt
Smusso
Romo
Mousse

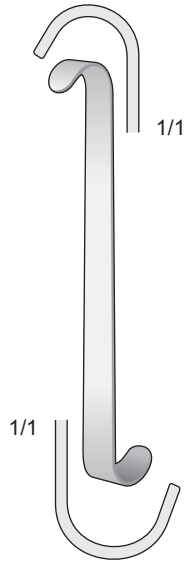

LUER
DS-16
110 mm

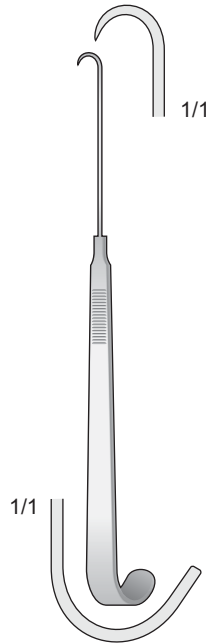

NEWS
DS-19
150 mm

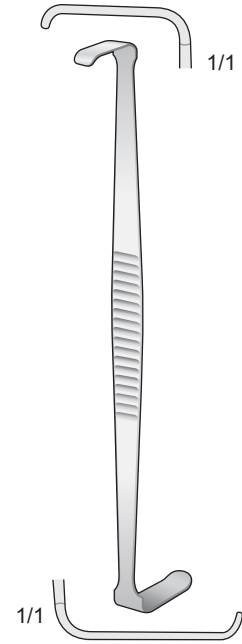

HOUSE
DS-20
150 mm

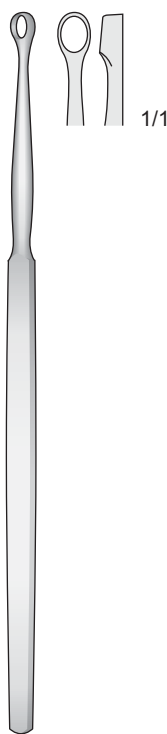

FOX
DS-30/DS-33
140 mm



3 mm
DS-30
1/1



4 mm
DS-31
1/1



5 mm
DS-32
1/1



6 mm
DS-33
1/1



WOLF
DS-34/DS-39
140 mm



Fig. 1
DS-34
1/1



Fig. 2
DS-35
1/1



Fig. 3
DS-36
1/1



Fig. 4
DS-37
1/1

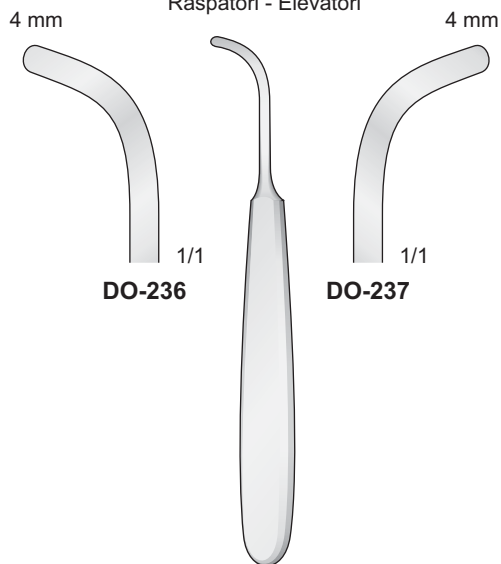

Fig. 5
DS-38
1/1



Fig. 6
DS-39
1/1

Raspatorien
Periosteal Elevators
Raspatori - Elevatori



DO-236

DO-237

DO-236/DO-237
140 mm

new

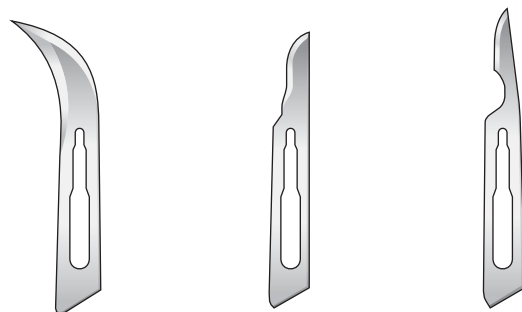

LB-12D

LB-15A

LB-15C

Stumpf
Blunt
Smussa
Romas
Mousse

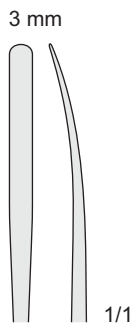

NK-1
100 mm



NK-3
130 mm



NK-2
150 mm

Stumpf
Blunt
Smussa
Romas
Mousse

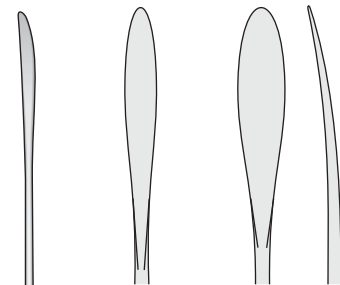

KO-32
140 mm

KO-33
235 mm



KO-31
180 mm



KO-32/KO-33

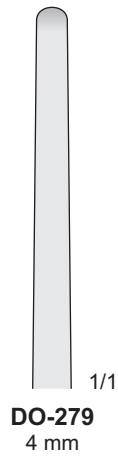
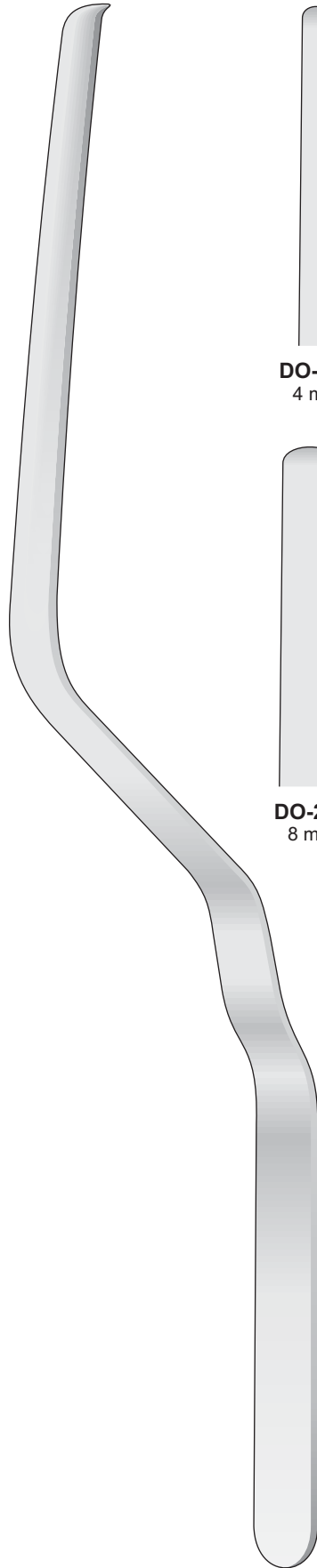

DO-279
4 mm

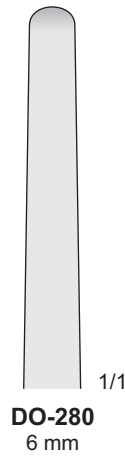

DO-280
6 mm

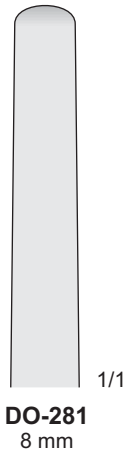

DO-281
8 mm

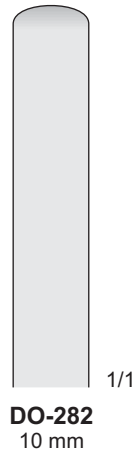

DO-282
10 mm

CASPAR
DO-279/DO-282
240 mm

Femur-Wundspreizer für kinder
Femur Retractor for children
Divaricatore femorale per bambini

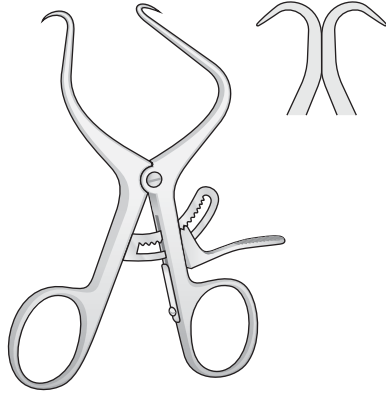

DE BAKEY
BV-315
100 mm

Femur-Wundspreizer
Femur Retractor
Divaricatore femorale

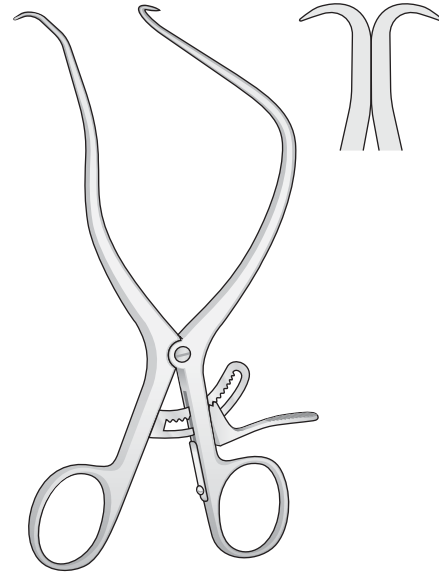

DE BAKEY
BV-316
170 mm

Wundspreizer
Retractors for shoulder
Divaricatori da spalla
Separadores
Ecarteurs

Stumpf - Blunt
Smusso - Romo
Mousse

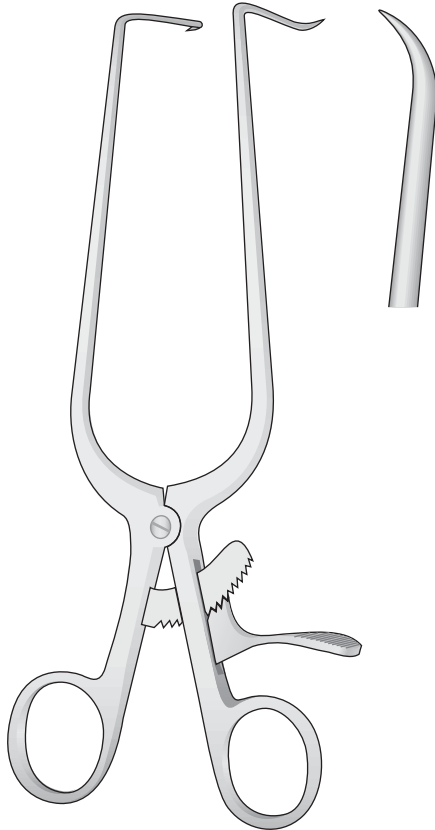

BV-100
215 mm

Stumpf - Blunt
Smusso - Romo
Mousse

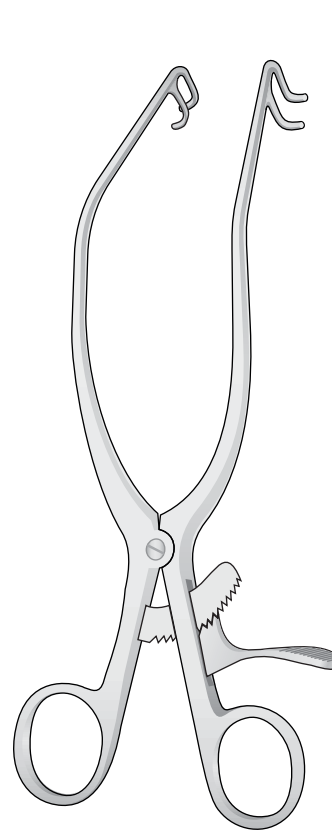

KÖLBEL
BV-103
180 mm

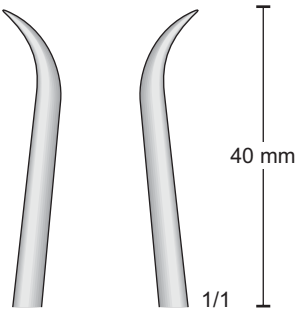



1/1

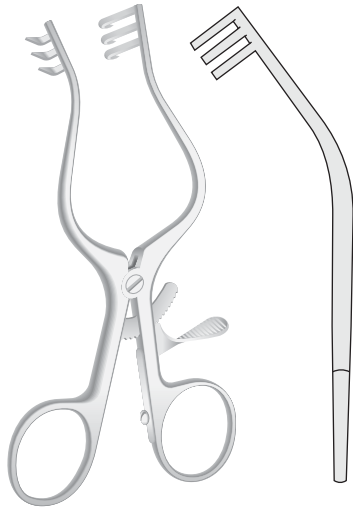

Scharf
Sharp
Acuto
Agudo
Pointu

WULLSTEIN
BV-113
130 mm



1/1

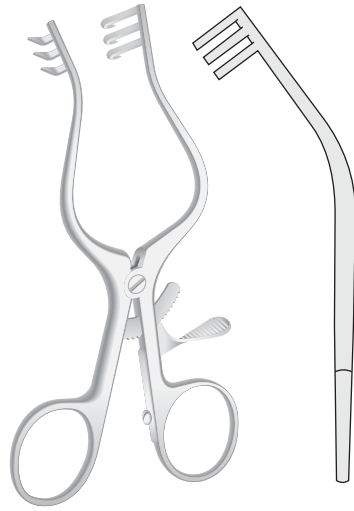

Stumpf
Blunt
Smusso
Romo
Mousse

WULLSTEIN
BV-114
130 mm

Scharf
Sharp
Acuto
Agudo
Pointu

Stumpf
Blunt
Smusso
Romo
Mousse

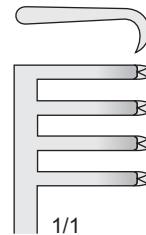

1/1

BV-104

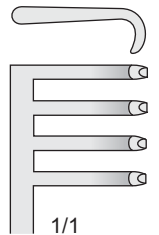

1/1

BV-105



1/1

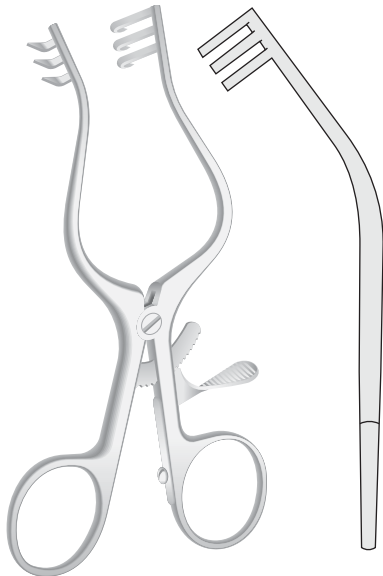

Scharf
Sharp
Acuto
Agudo
Pointu

WULLSTEIN
BV-115
160 mm



1/1

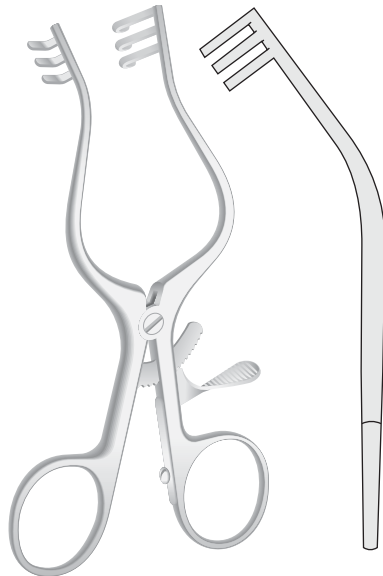

Stumpf
Blunt
Smusso
Romo
Mousse

WULLSTEIN
BV-116
160 mm



SCALP-CONTOUR
BV-104/BV-105
135 mm

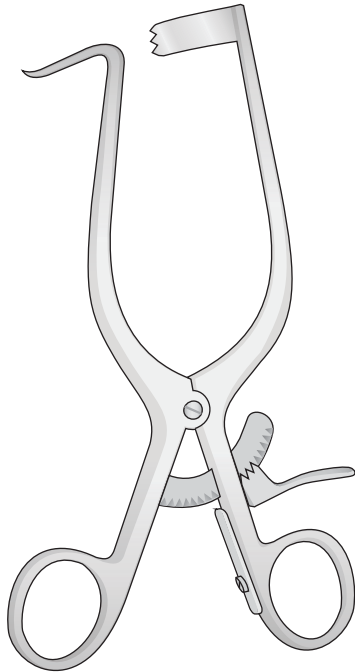

WILLIAMS
BV-401/BV-403
170 mm

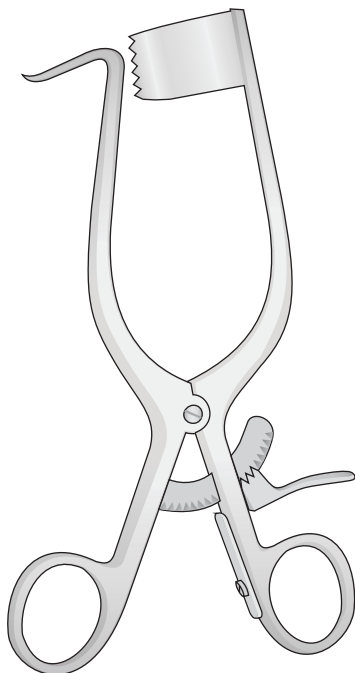

WILLIAMS
BV-404/BV-406
170 mm

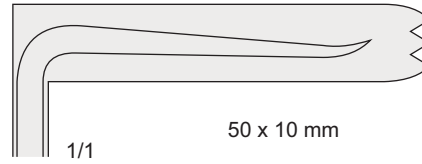

BV-401

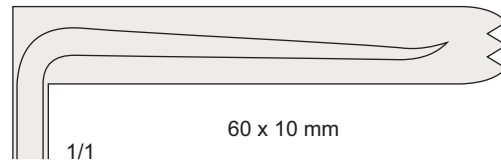

BV-402

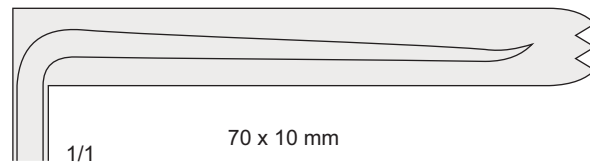

BV-403

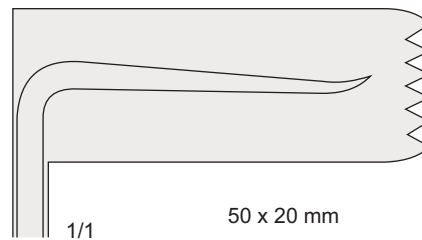

BV-404

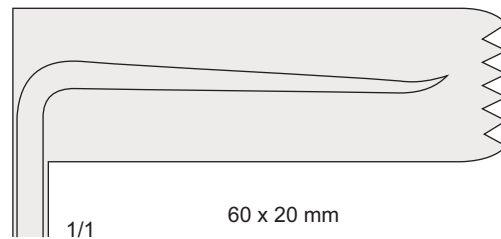

BV-405

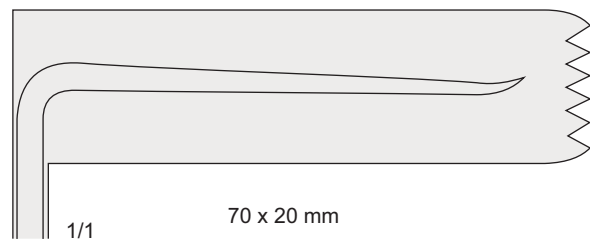

BV-406

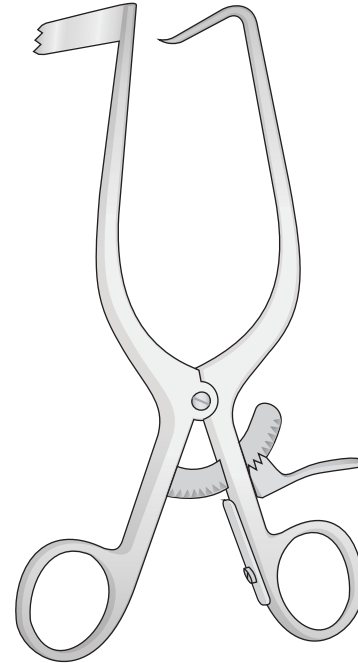
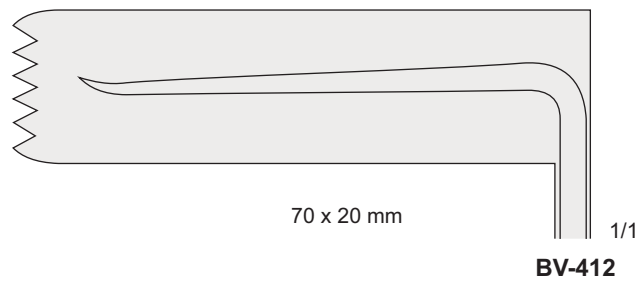
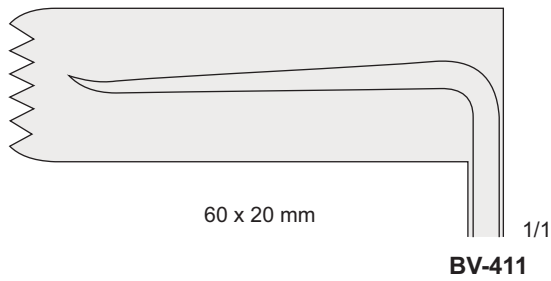
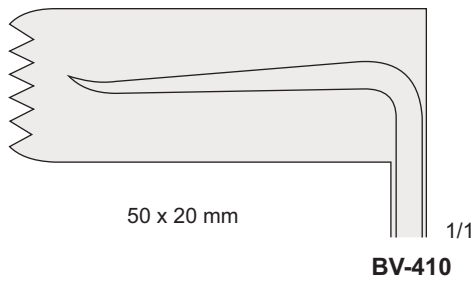
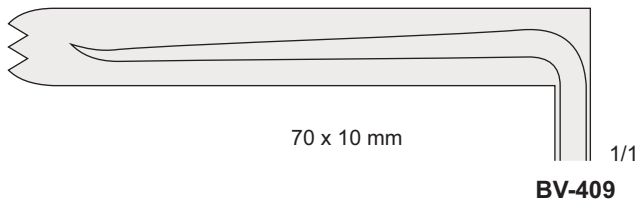
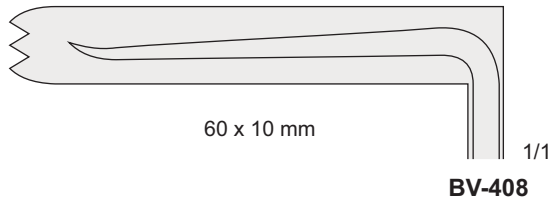
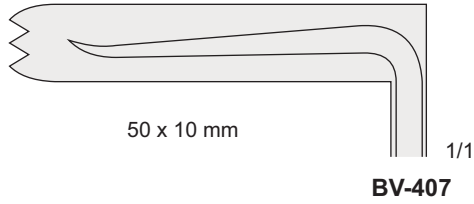

WILLIAMS
BV-407/BV-409
170 mm

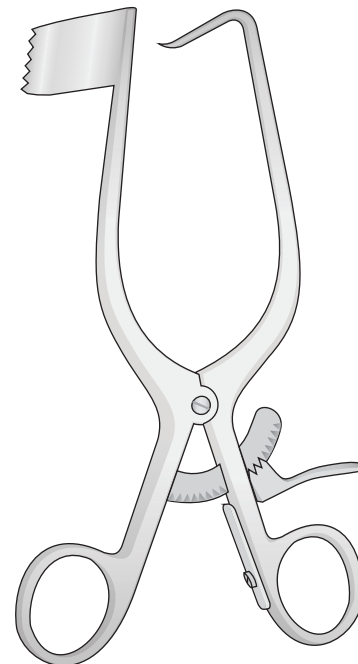

WILLIAMS
BV-410/BV-412
170 mm

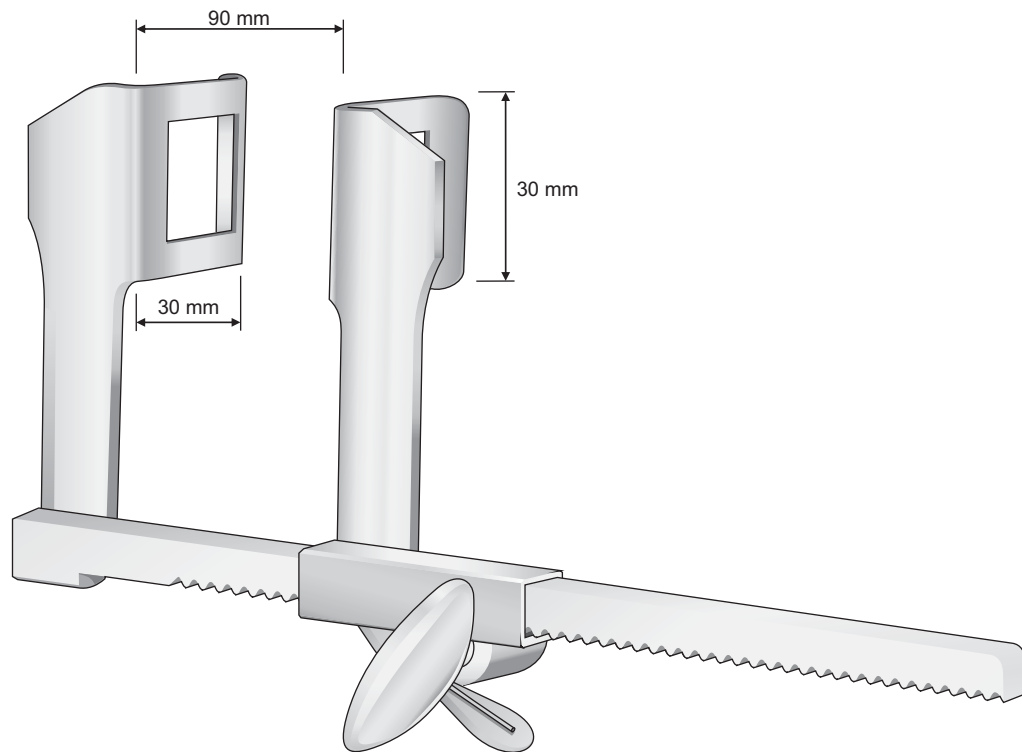

HAIGHT
BV-67

CASPAR
FF-190 Distraktor komplett rechts
 Distractor complete right
 Distrattore completo destro
FF-191 1 Distraktor allein - 1 Distractor only
FF-192 1 Bohrbüchse - 1 Drilling Guide
FF-203 1 Spezialbohrer - 1 Special Drill
FF-205 2 Distraktionsschrauben - 2 Distraction Screws
FF-206 1 Schraubendreher - 1 Screw Driver

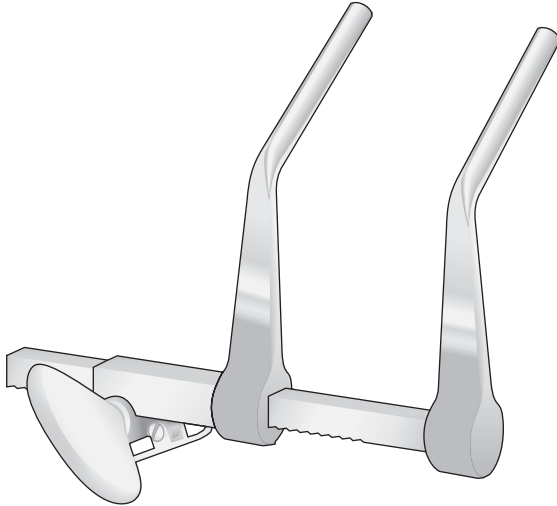

CASPAR
FF-191
 Distraktor rechts, Allein
 Distractor right, Only
 Distrattore destro, solo

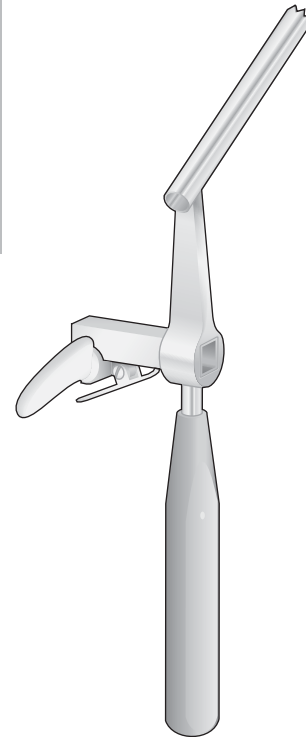

FF-192
 Bohrbüchse rechts, Allein
 Drilling Guide right, Only
 Guida punte destro, solo

CASPAR
FF-200 Distraktor komplett links
 Distractor complete left
 Distrattore completo sinistro
FF-201 1 Distraktor allein - 1 Distractor only
FF-202 1 Bohrbüchse - 1 Drilling Guide
FF-203 1 Spezialbohrer - 1 Special Drill
FF-205 2 Distraktionsschrauben - 2 Distraction Screws
FF-206 1 Schraubendreher - 1 Screw Driver

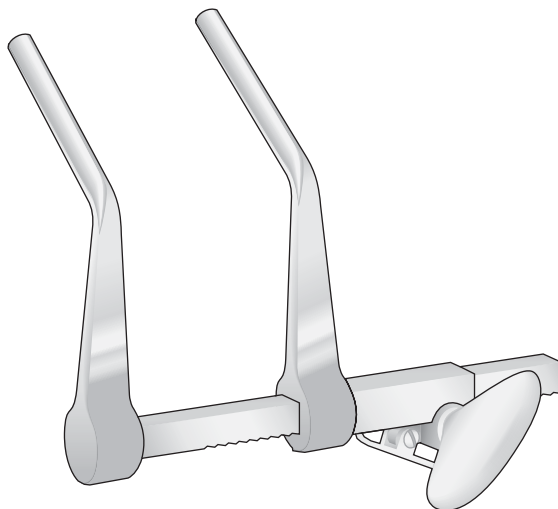

CASPAR
FF-201
 Distraktor links, Allein
 Distractor left, Only
 Distrattore sinistro, solo

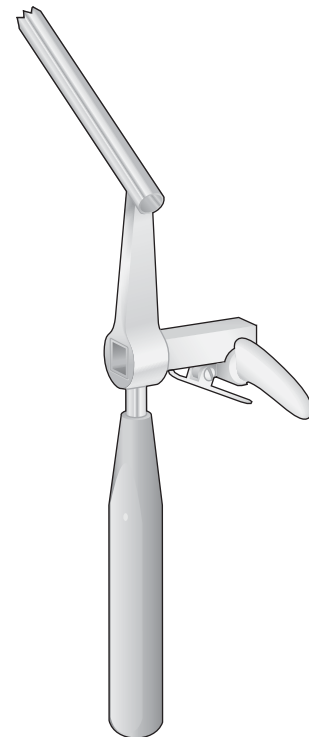

FF-202
 Bohrbüchse links, Allein
 Drilling Guide left, Only
 Guida punte sinistro, solo

19



Screw Driver
Schraubendreher



CASPAR
FF-206
200 mm

Special Drill
Spezialbohrer
Ø 1,7 mm

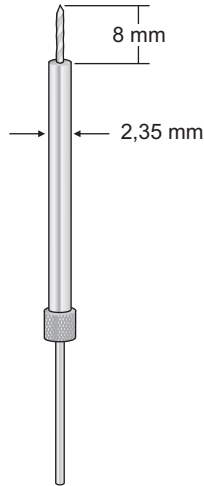

CASPAR
FF-203
145 mm

Distraction Screw
Distraktionsschrauben

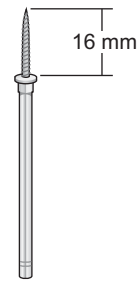

CASPAR
FF-205
70 mm

- CASPAR
FF-200
Distraktor komplett links
Distractor complete left
Distrattore completo sinistro
- FF-201** 1 Distraktor allein - 1 Distractor only
- FF-202** 1 Bohrbüchse - 1 Drilling Guide
- FF-203** 1 Spezialbohrer - 1 Special Drill
- FF-205** 2 Distraktionsschrauben - 2 Distraction Screws
- FF-206** 1 Schraubendreher - 1 Screw Driver

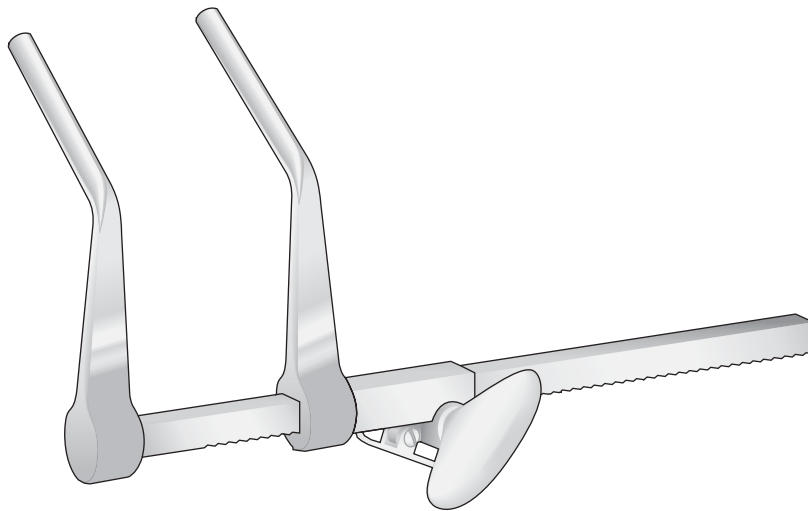

CASPAR
FF-201M
Distraktor links, Allein
Distractor left, Only
Distrattore sinistro, solo

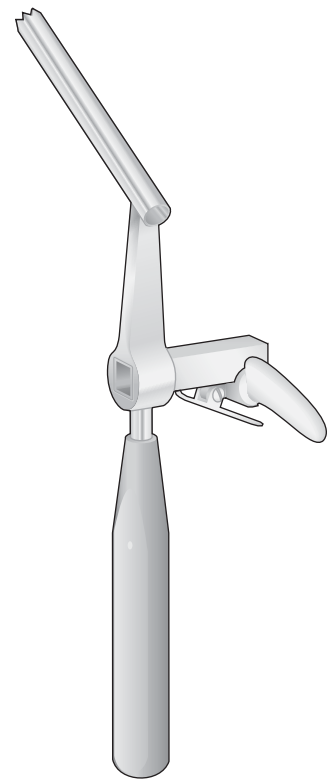

FF-202
Bohrbüchse links, Allein
Drilling Guide left, Only
Guida punta sinistro, solo



Screw Driver
Schraubendreher



CASPAR
FF-206
200 mm

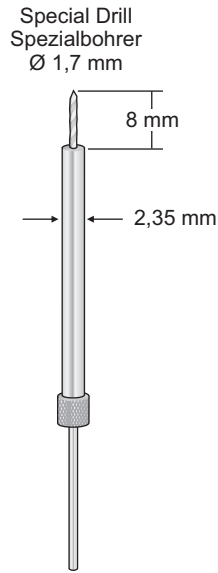

CASPAR
FF-203
145 mm

Distraction Screw
Distractionsschrauben

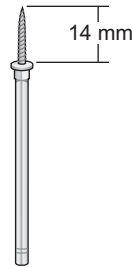

CASPAR
FF-204
70 mm

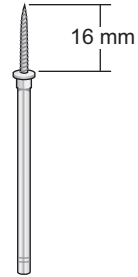

CASPAR
FF-205
70 mm

A



CHANDLER
FK-117/FK-128

A= 13,0 mm

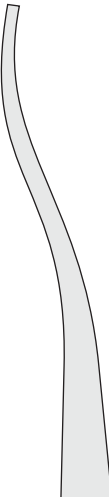

FK-117
190 mm

A= 20,0 mm

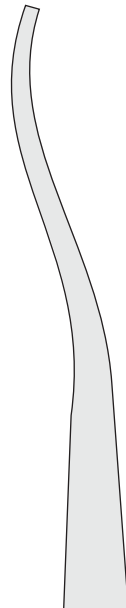

FK-118
200 mm

A= 25,5 mm



FK-127
230 mm

A= 31,5 mm

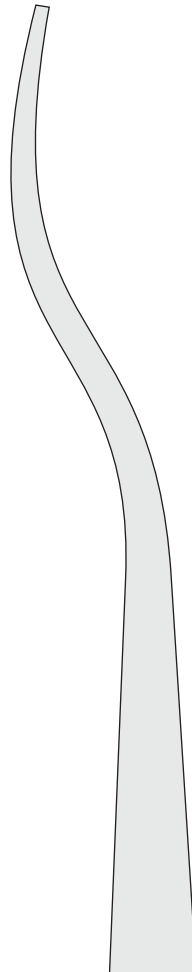

FK-128
255 mm

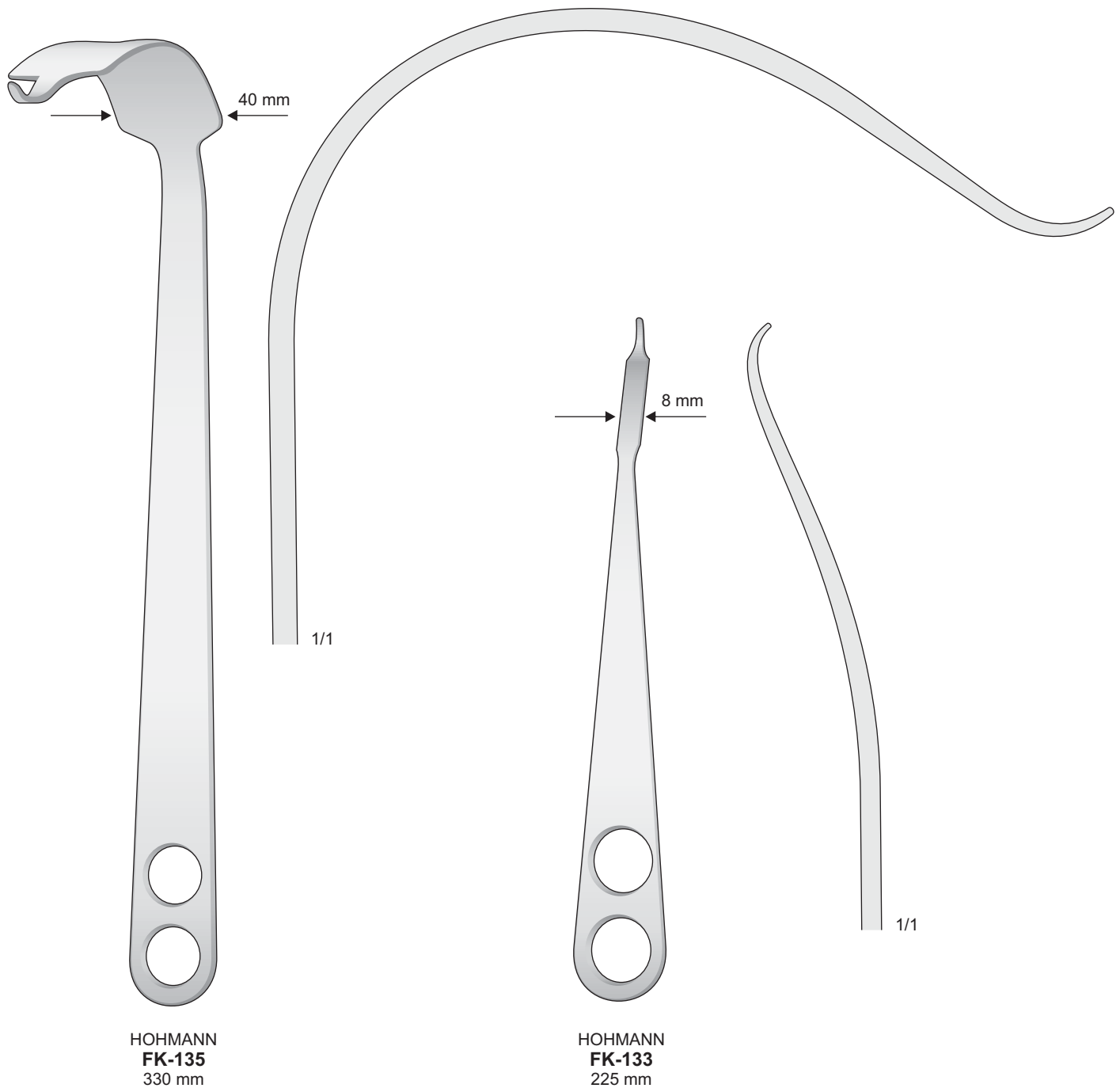

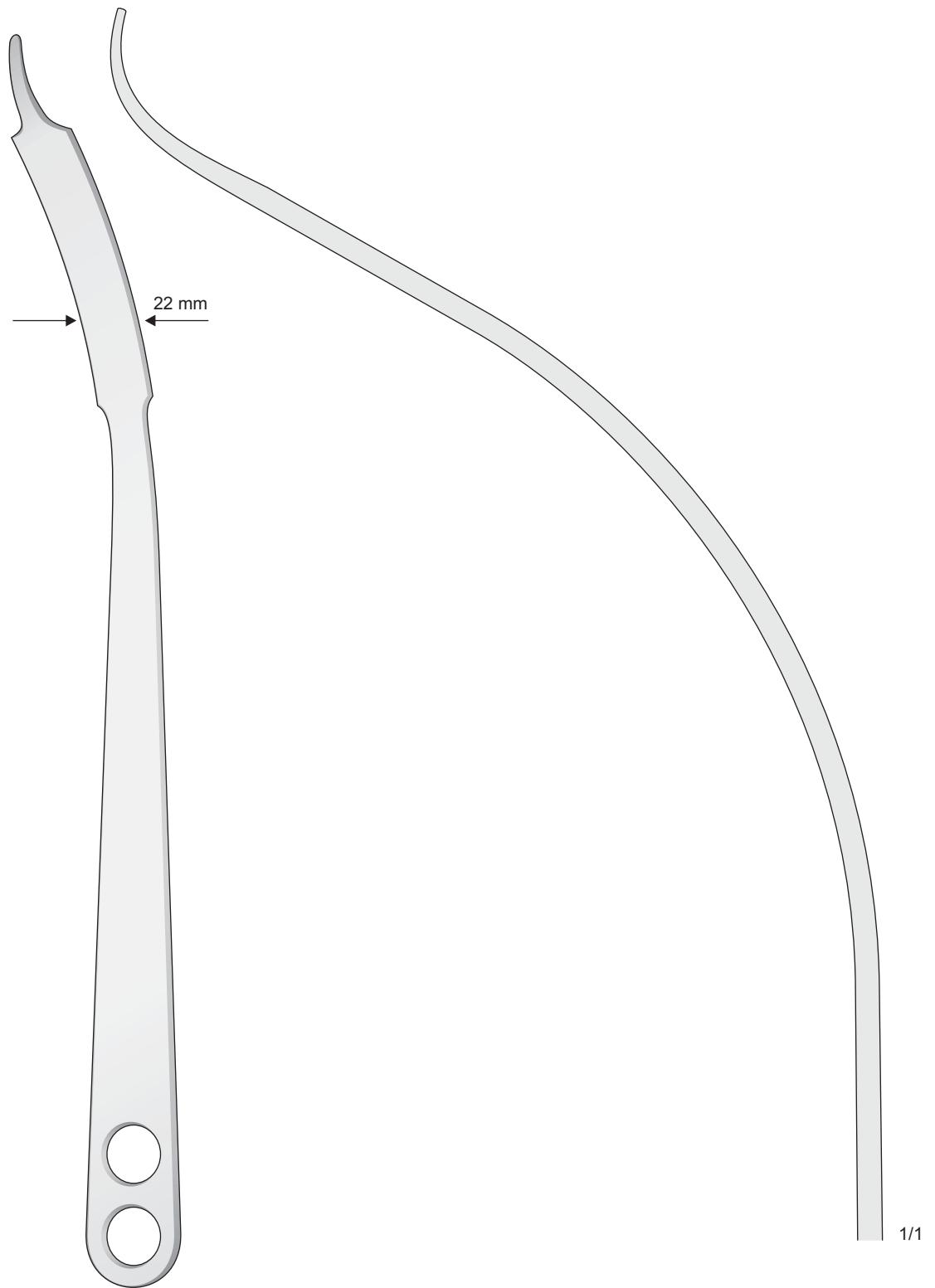

HOHMANN
FK-134
400 mm

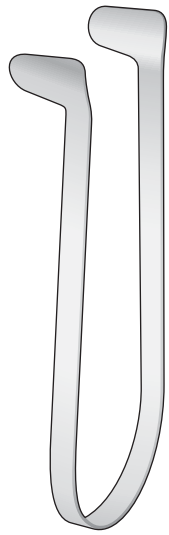

THUDICUM
OM-181/OM-187



OM-181



OM-182

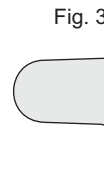

OM-183

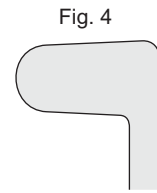

OM-184

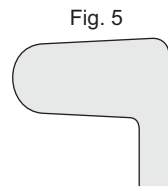

OM-185

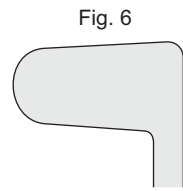

OM-186

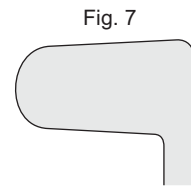

OM-187

Zungenspatel - Tongue Depressor
Adenotomie - Tonsillektomie

10 x 13 mm



LACK
OM-93

13 x 19 mm



LACK
OM-94

15 x 22 mm



LACK
OM-95

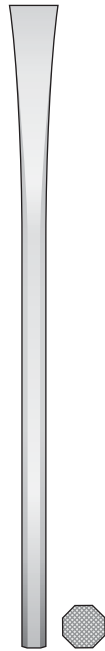

SHEEHAN
FL-380/FL-388
160 mm

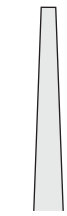

FL-380
2 mm



FL-381
4 mm



FL-382
6 mm



FL-383
8 mm



FL-384
10 mm



FL-385
12 mm

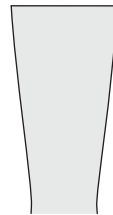

FL-386
15 mm



FL-387
18 mm



FL-388
20 mm

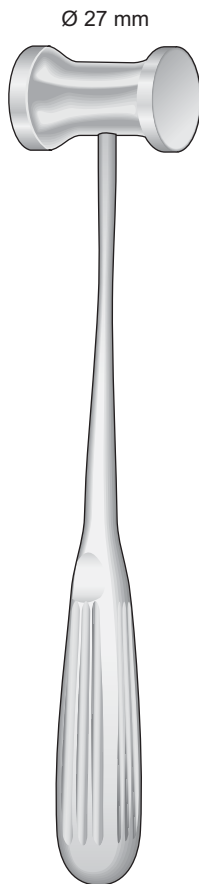

HAJEK
FL-128
220 mm

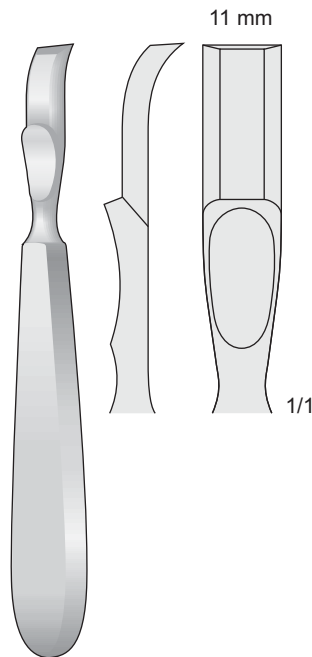

FARABEU-FOLLIN
FK-253
160 mm

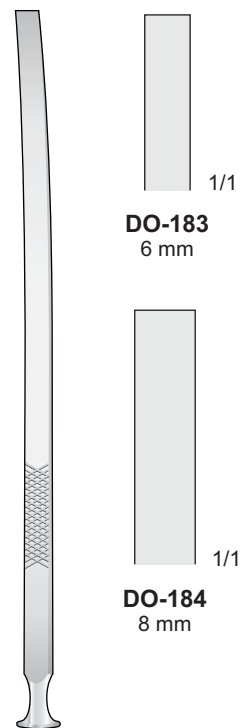

EPKER
DO-183/DO-184
180 mm

8 mm



COSCIA
FL-368
180 mm



ALEXANDER
FL-206/FL-209
170 mm

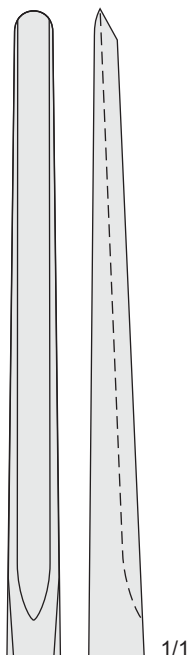

FL-206
5 mm

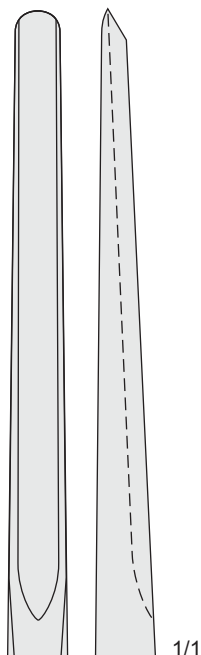

FL-207
7 mm

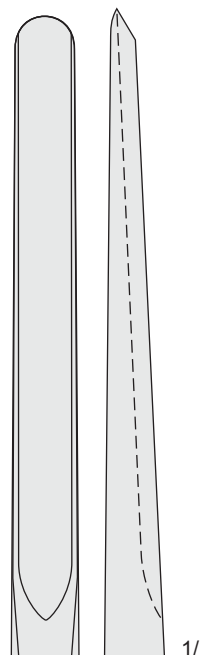

FL-208
9 mm

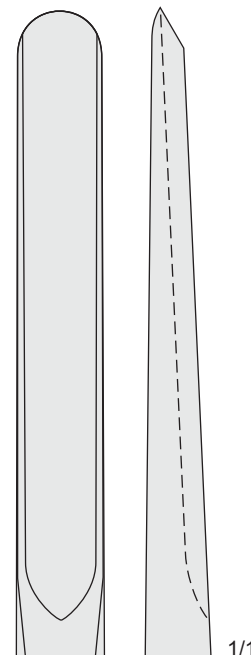

FL-209
11 mm

Fig.5/0
2,2 mm
1/1
FK-280

Fig.4/0
2,5 mm
1/1
FK-281

Fig.3/0
2,8 mm
1/1
FK-282

Fig.2/0
3,3 mm
1/1
FK-283

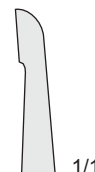

Fig.0
3,6 mm
1/1
FK-284

Fig.1
4,3 mm
1/1
FK-285

Fig.2
4,8 mm
1/1
FK-286

Fig.3
5,6 mm
1/1
FK-287

Fig.4
6,0 mm
1/1
FK-288

Fig.5
6,7 mm
1/1
FK-289

Fig.6
8,8 mm
1/1
FK-290

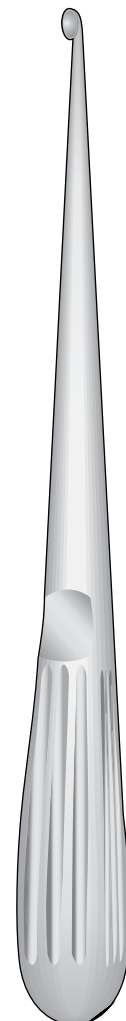

BRUNS
FK-280/FK-290

170 mm

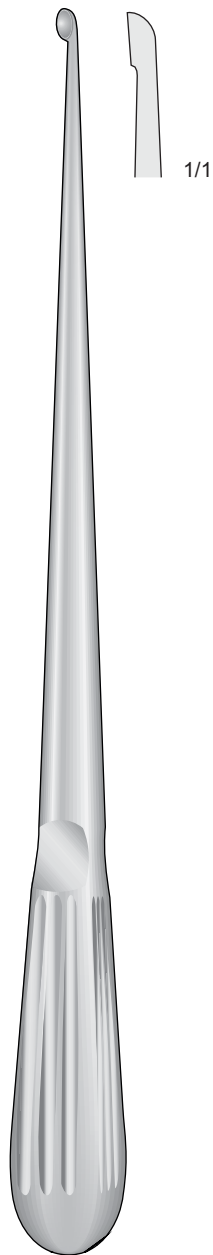

BRUNS
FK-291/FK-299
225 mm

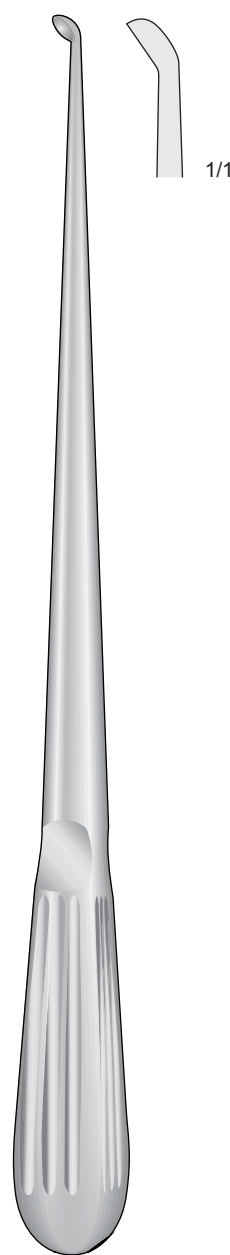

BRUNS
FK-300/FK-308
225 mm

Fig.3/0
2,8 mm



1/1

FK-291

Fig.2/0
3,3 mm



1/1

FK-292

Fig.0
3,6 mm



1/1

FK-293

Fig.1
4,3 mm



1/1

FK-294

Fig.2
4,8 mm



1/1

FK-295

Fig.3
5,6 mm



1/1

FK-296

Fig.4
6,0 mm



1/1

FK-297

Fig.5
6,7 mm



1/1

FK-298

Fig.6
8,8 mm



1/1

FK-299

Fig.3/0
2,8 mm



1/1

FK-300

Fig.2/0
3,3 mm



1/1

FK-301

Fig.0
3,6 mm



1/1

FK-302

Fig.1
4,3 mm



1/1

FK-303

Fig.2
4,8 mm



1/1

FK-304

Fig.3
5,6 mm



1/1

FK-305

Fig.4
6,0 mm



1/1

FK-306

Fig.5
6,7 mm



1/1

FK-307

Fig.6
8,8 mm



1/1

FK-308

Mit Ferrozellgriff - With Ferrozell handle
 Con manico Ferrozell - Con mango de Ferrozell
 Avec poignée en Ferrozell

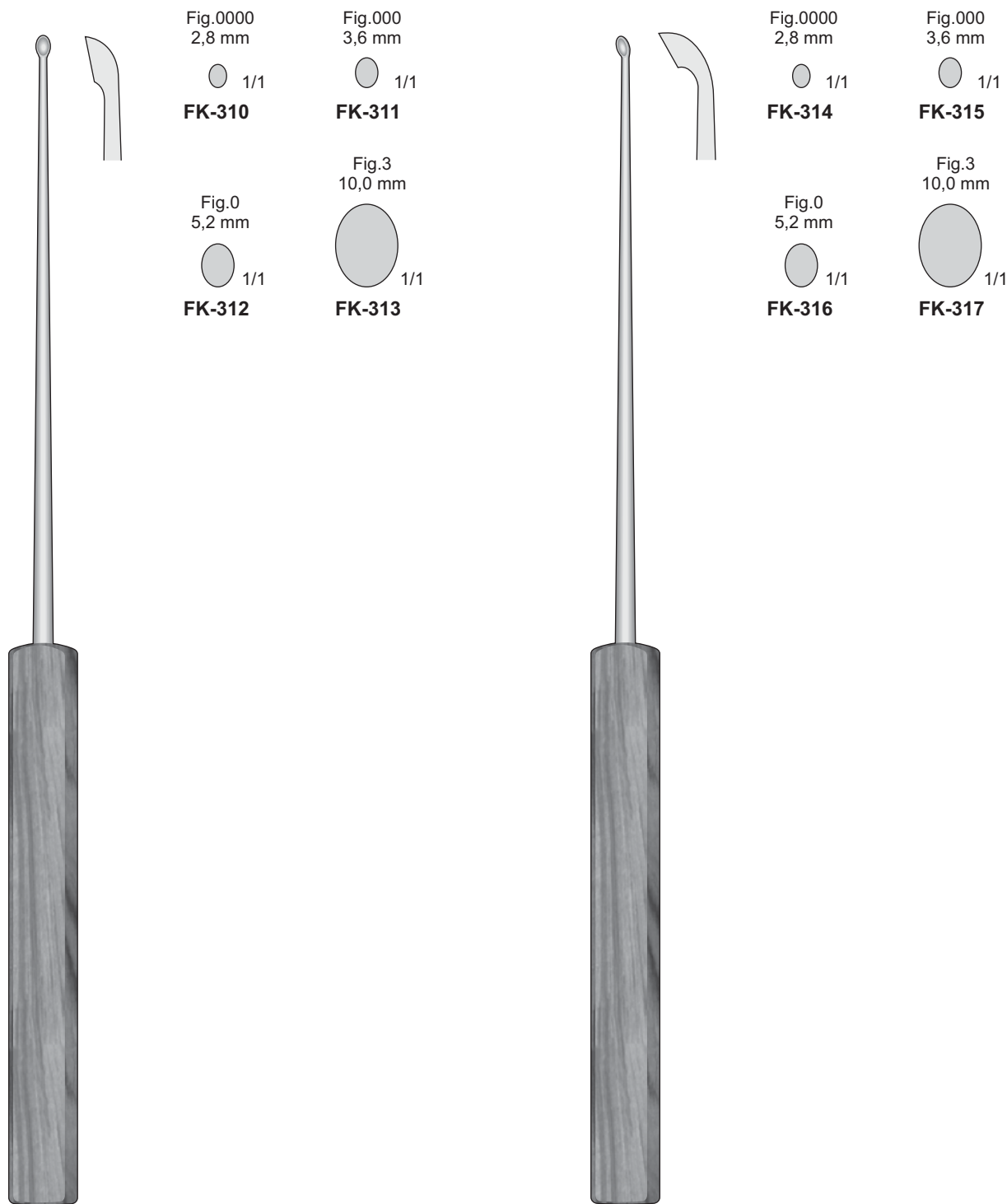

SYPERT
FK-310/FK-313
 380 mm

SYPERT
FK-314/FK-317
 380 mm

Mit Ferrozellgriff - With Ferrozell handle
Con manico Ferrozell - Con mango de Ferrozell
Avec poignée en Ferrozell

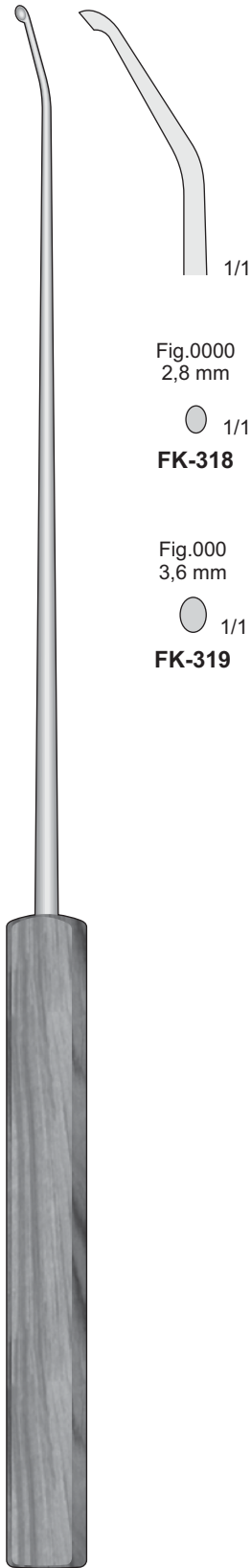

SYPERT
FK-318/FK-319
420 mm

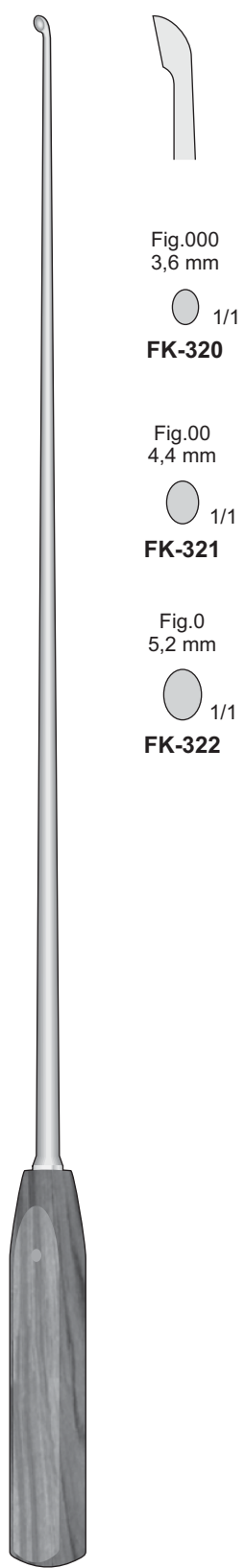

FK-320/FK-322
410 mm

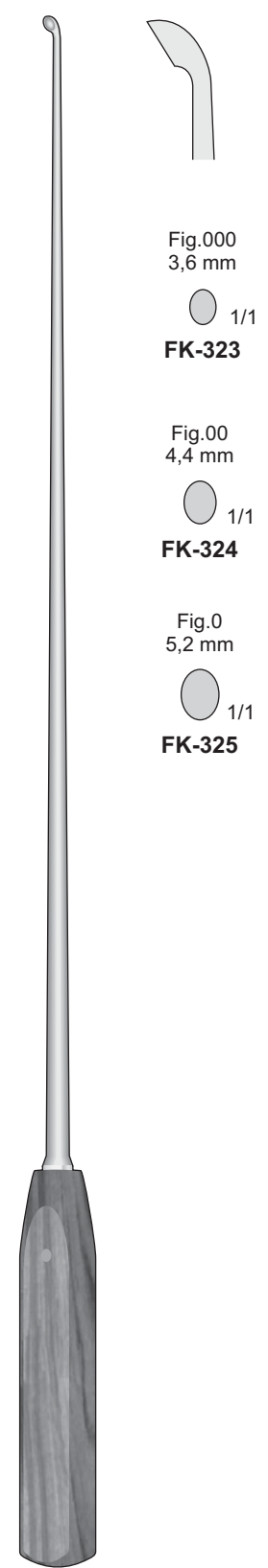

FK-323/FK-325
410 mm

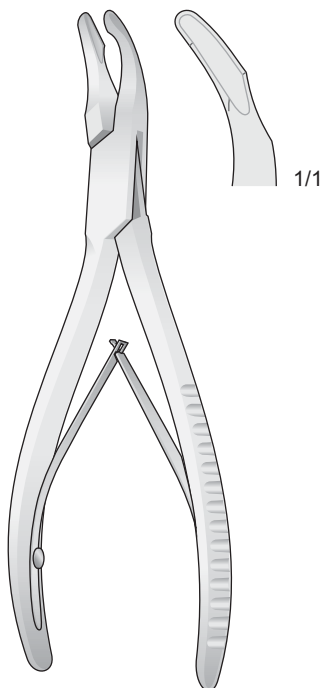

CLEVELAND
FO-231 140 mm
FO-232 170 mm

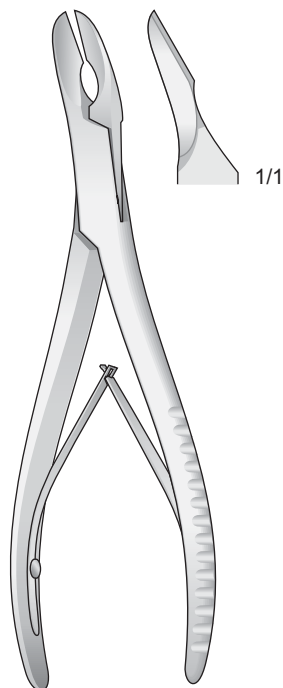

CLEVELAND
FO-233 150 mm
FO-234 170 mm

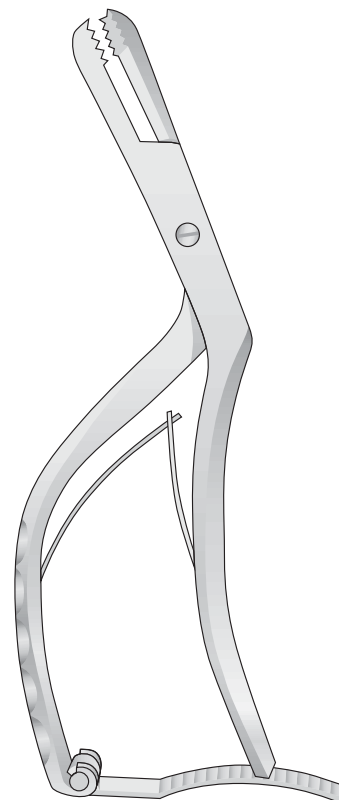

FO-140
200 mm

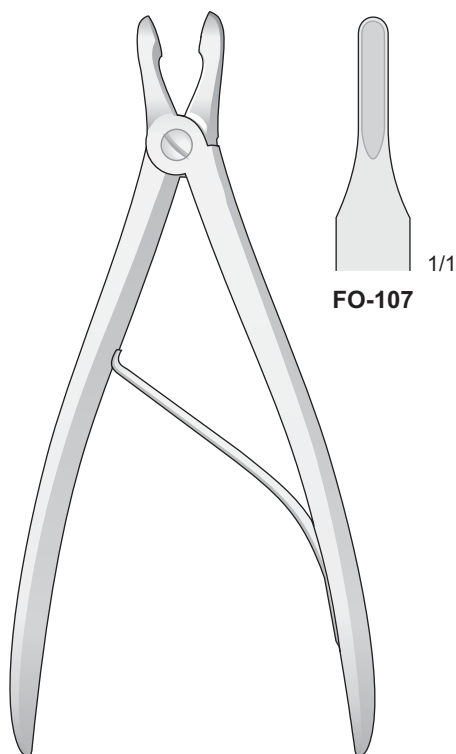

CUSHING
FO-107/FO-109
190 mm

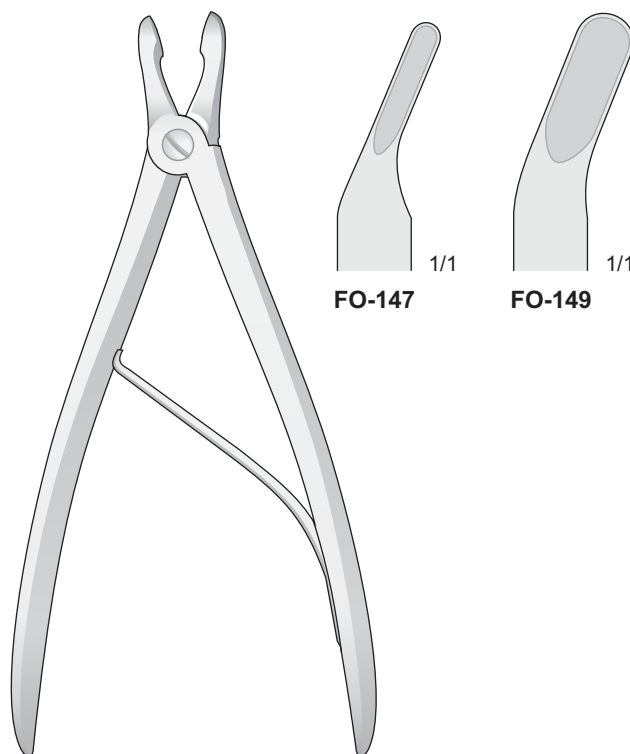

CUSHING
FO-147/FO-149
190 mm

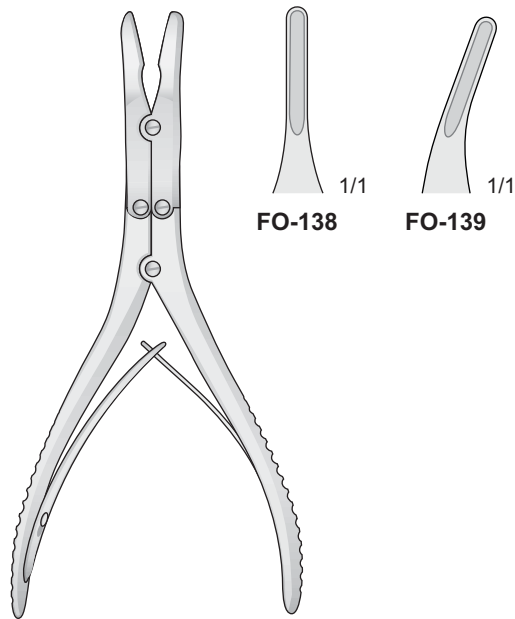

RUSKIN
FO-138/FO-139
150 mm

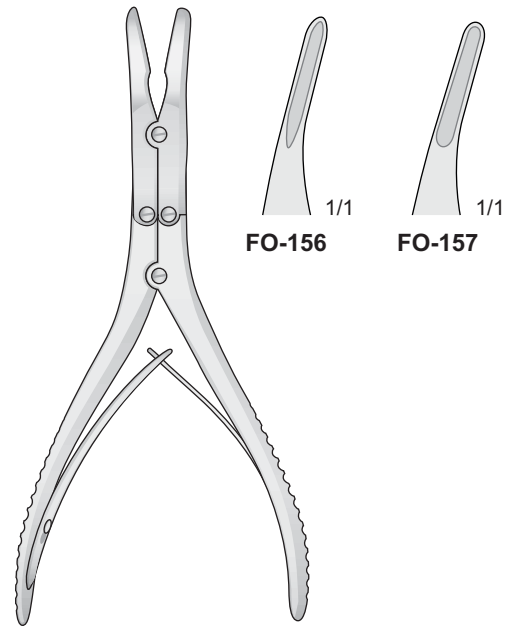

KLEINERT-KUTZ
FO-156/FO-157
155 mm

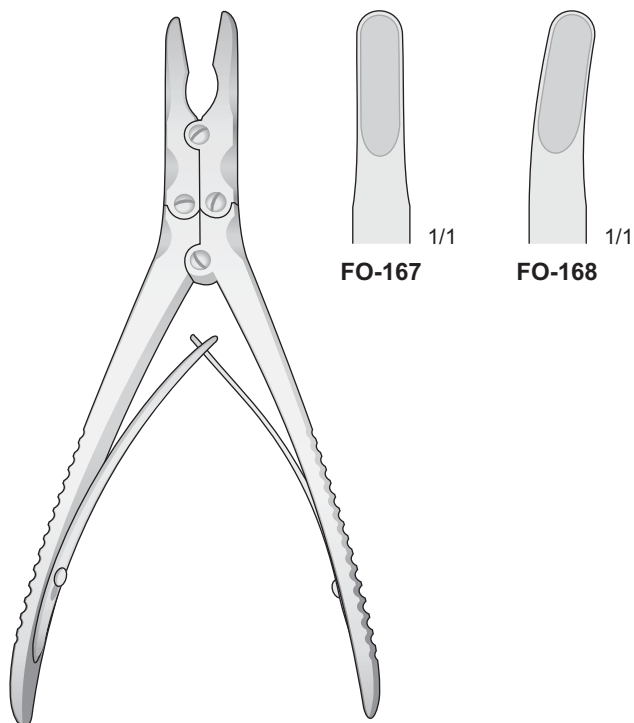

RUSKIN
FO-167/FO-168
185 mm

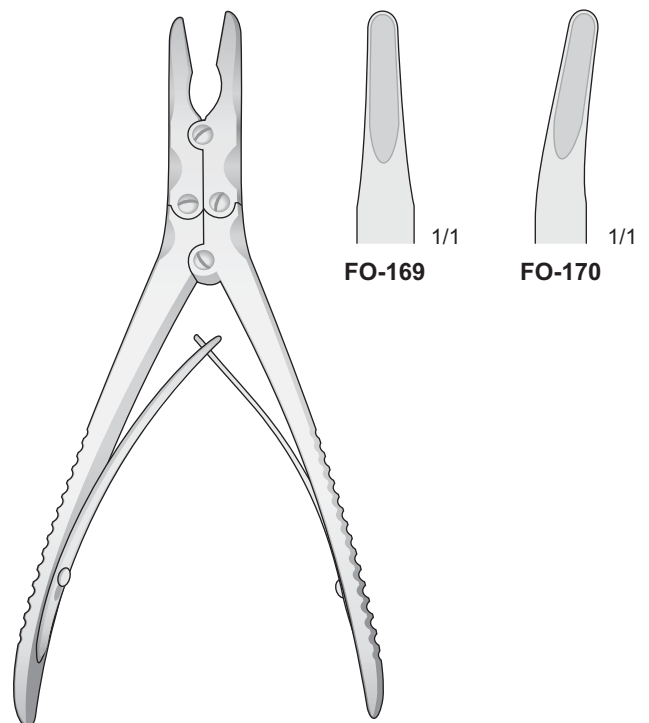

RUSKIN
FO-169/FO-170
185 mm

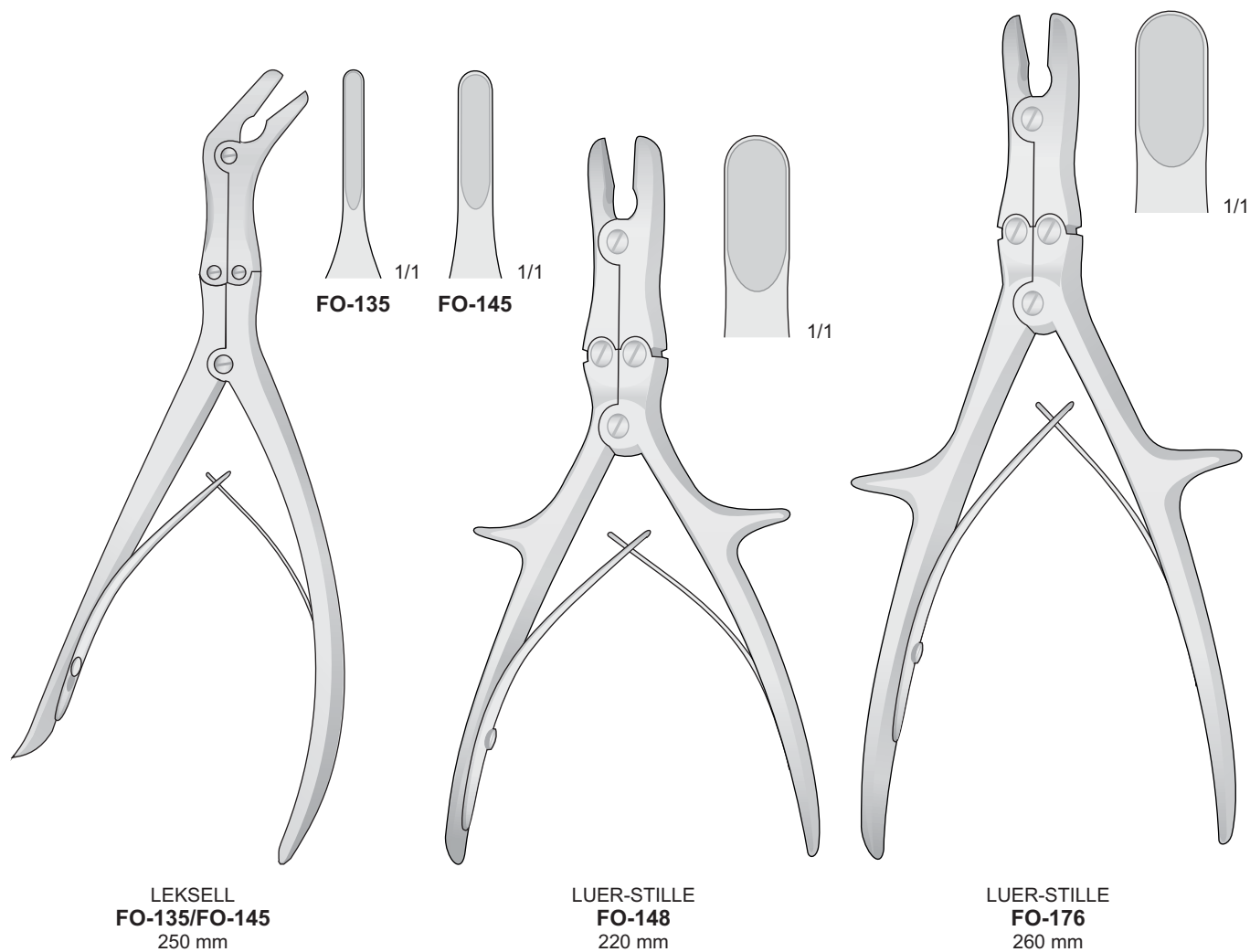

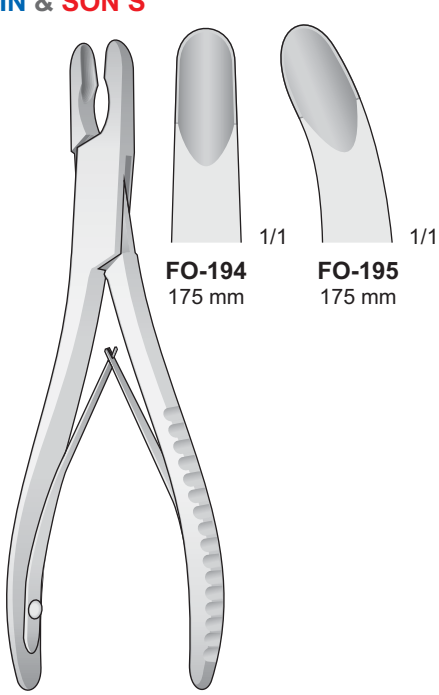

FO-194
175 mm

FO-195
175 mm

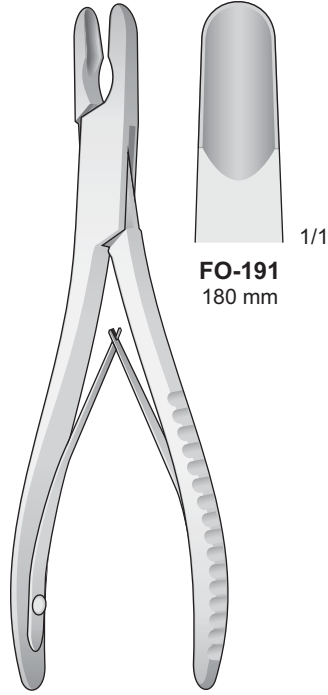

FO-191
180 mm

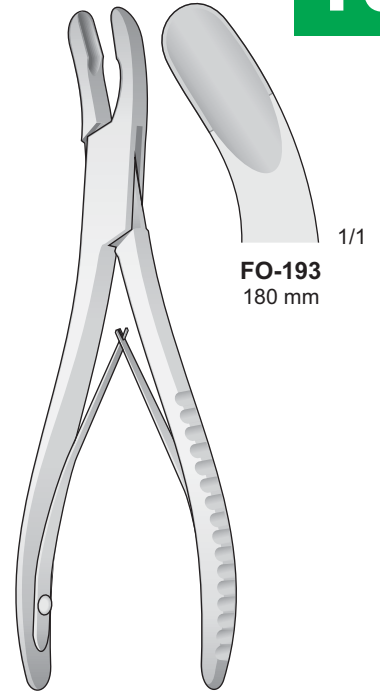

FO-193
180 mm

LUER
FO-194/FO-195
175 mm

LUER
FO-191
180 mm

LUER
FO-193
180 mm

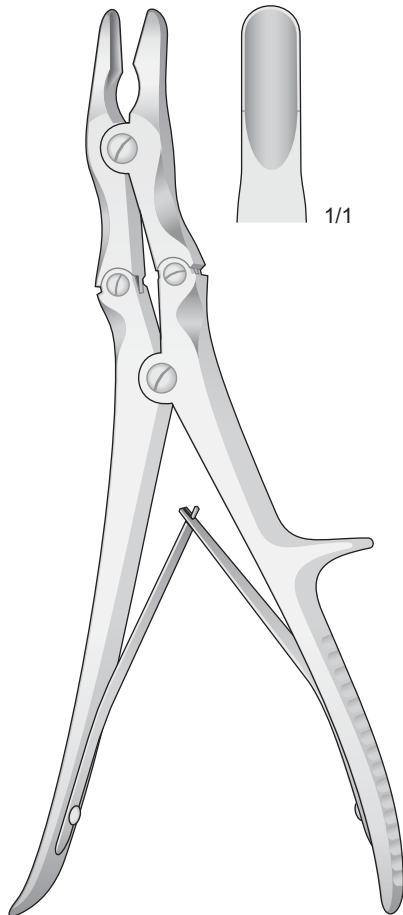

LEKSELL-STILLE
FO-196
240 mm

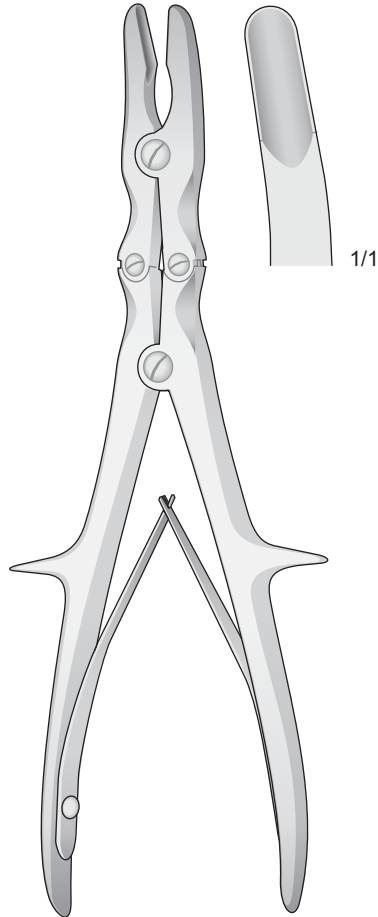

STILLE-RUSKIN
FO-197
240 mm

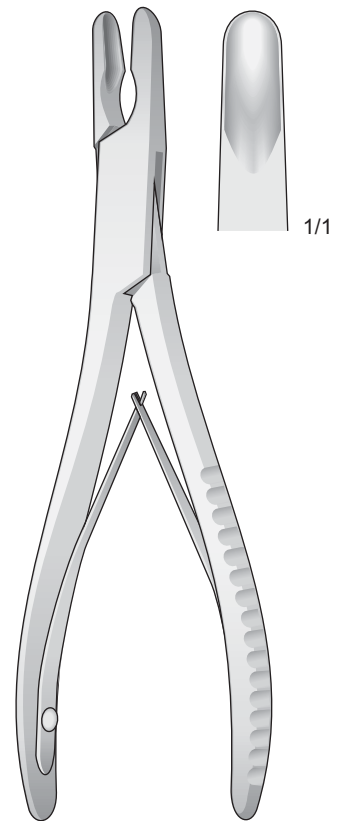

ADSON
FO-198
210 mm

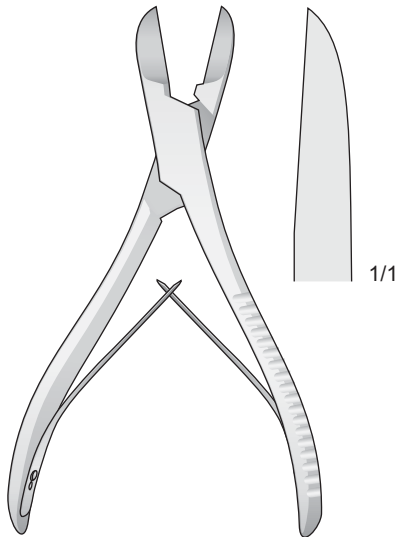

LISTON
LX-111
140 mm

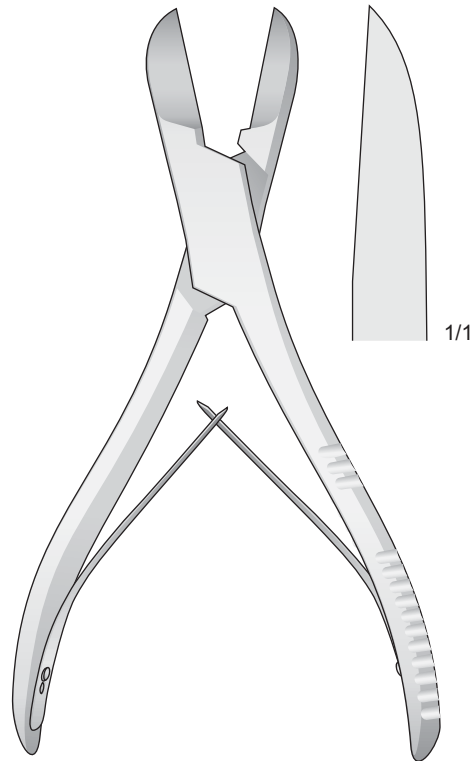

LISTON
LX-116
200 mm

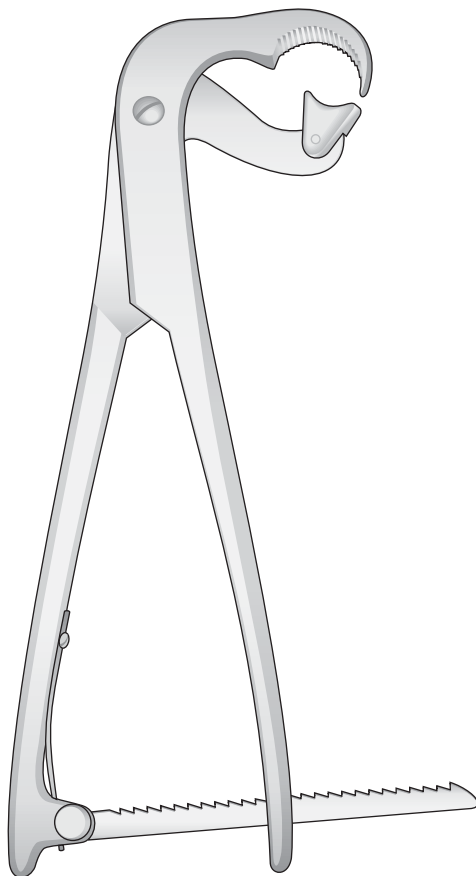

FO-106
275 mm

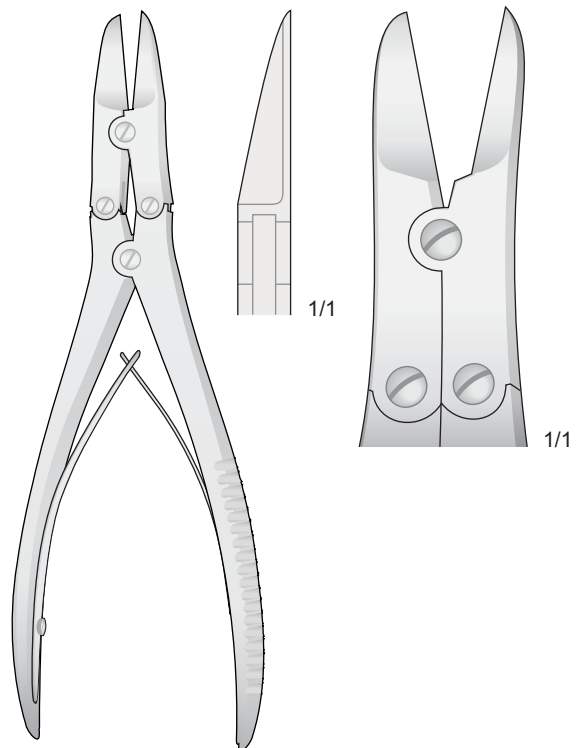

RUSKIN-LISTON
FO-178
190 mm

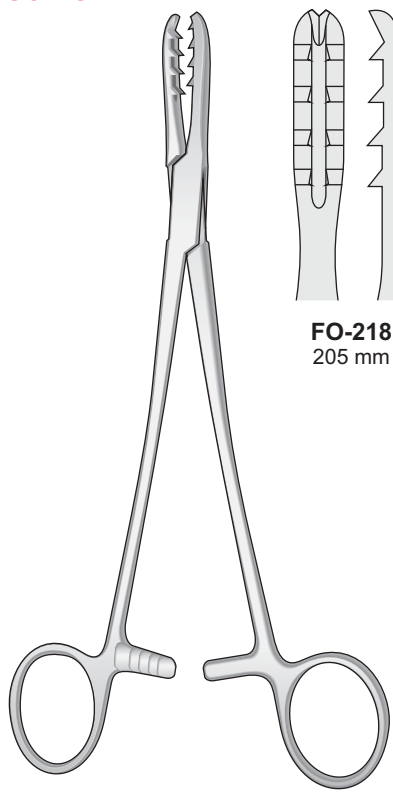

FO-218
205 mm

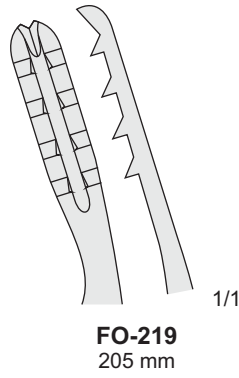

FO-219
205 mm

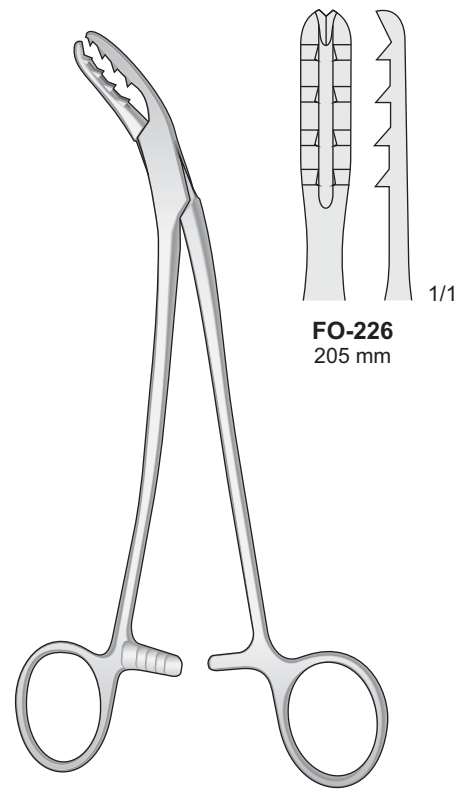

FO-226
205 mm

BIRCHER-GANSKE
FO-218/FO-219
205 mm

BIRCHER-GANSKE
FO-226
200 mm

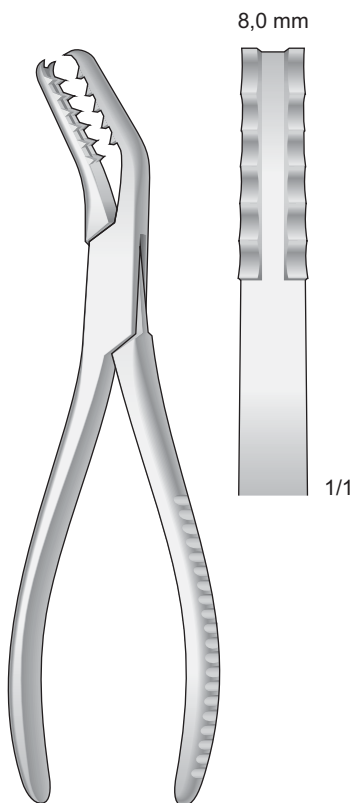

SEMB
FO-236
190 mm

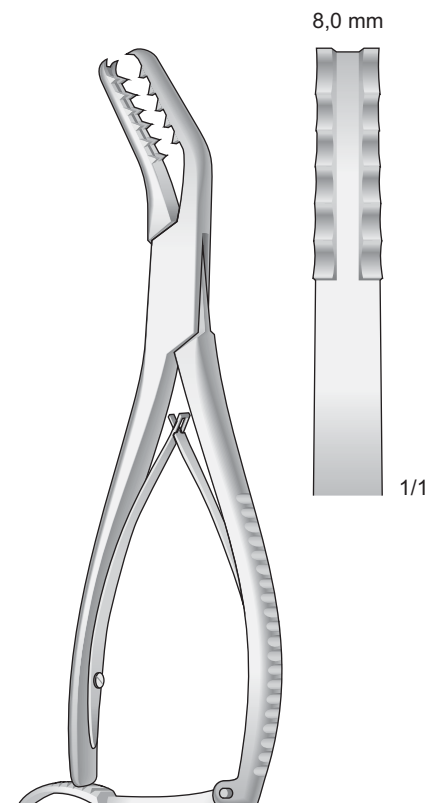

SEMB
FO-237
190 mm

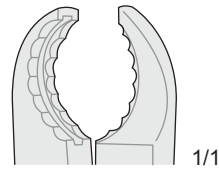
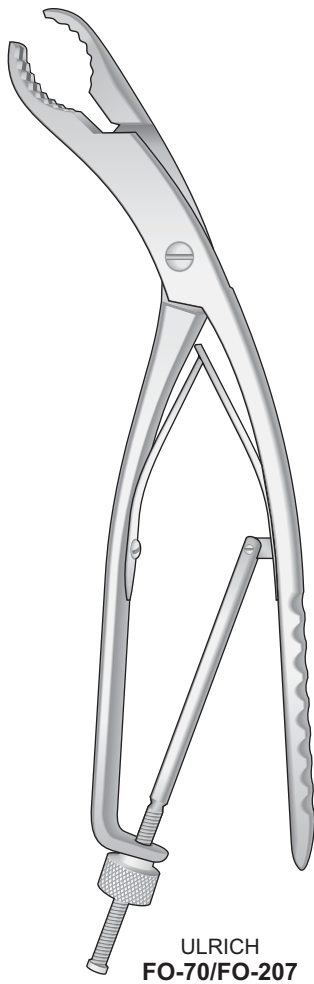
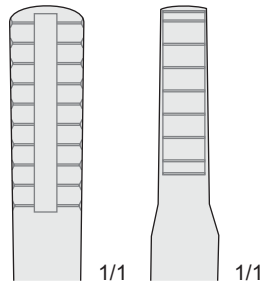
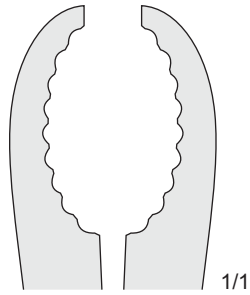

FO-206
220 mm

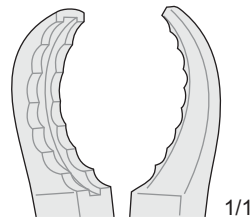

FO-207
240 mm

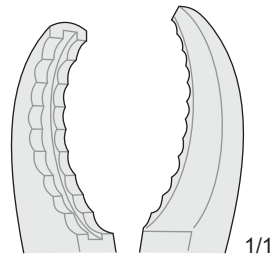

FO-70
270 mm

Ersatz für
Replacement for
Ricambio per
Repuesto para
FO-80

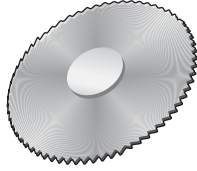

FO-80R

Von Kirschner-Drähten Ø 6 mm
For Kirschner wires Ø 6 mm
Per chiodi Kirschner Ø 6 mm

Von Kirschner-Drähten Ø 6 mm
For Kirschner wires Ø 6 mm
Per chiodi Kirschner Ø 6 mm

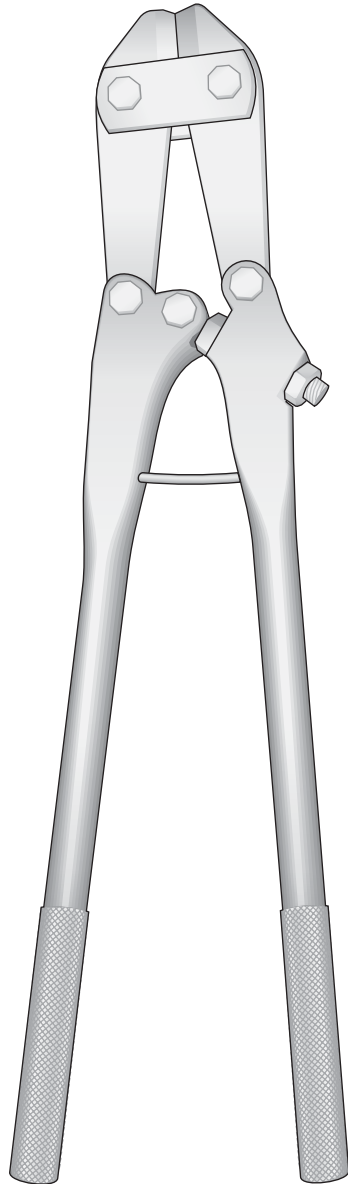

LX-150
450 mm

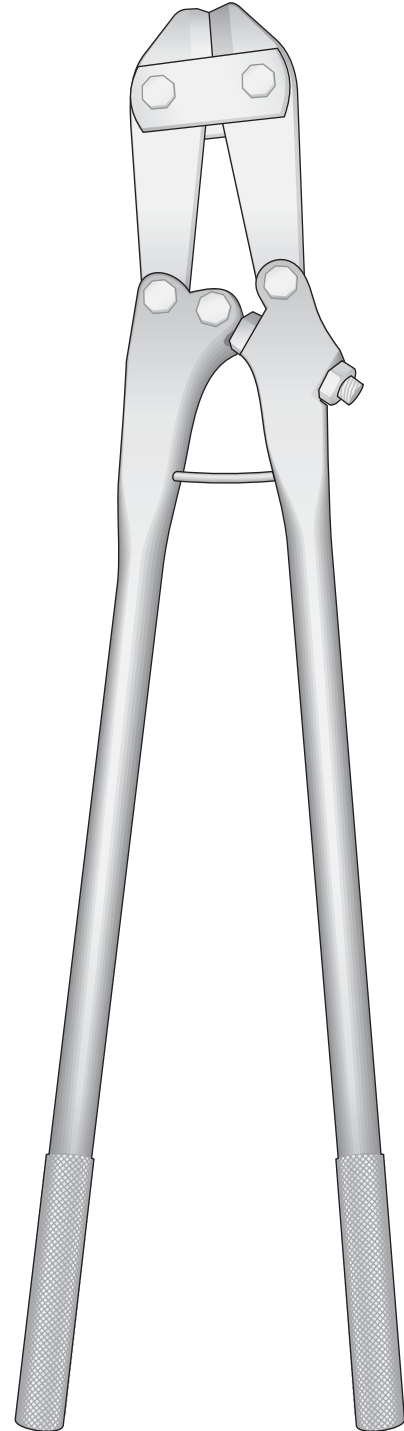

LX-151
560 mm

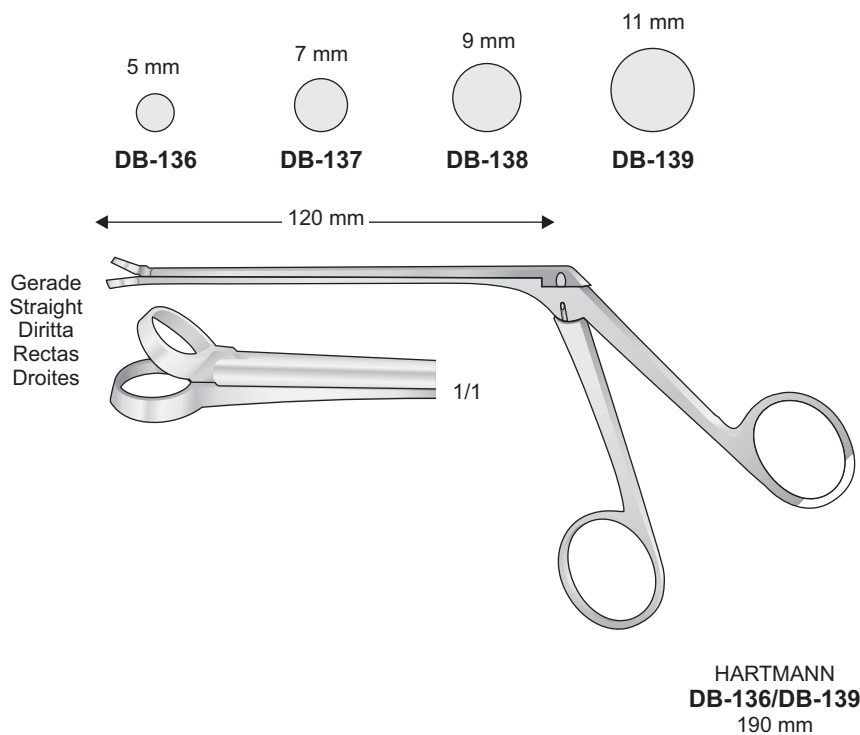
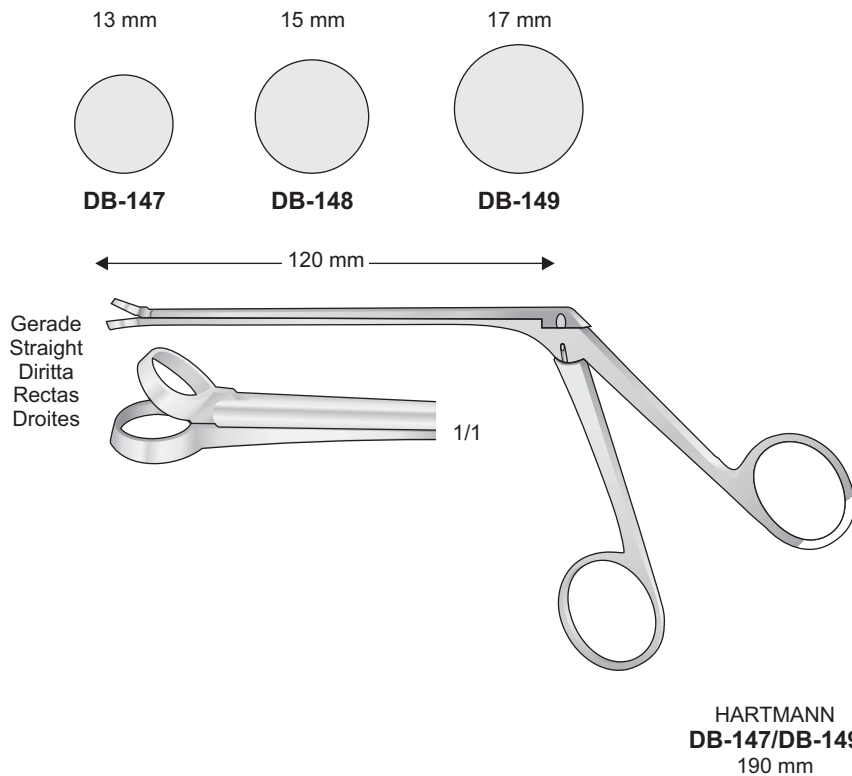

Sehenschäler
Tendon Stripper
Enucleatore per tendini
Enucleador de tendones
Décolleurs de tendons

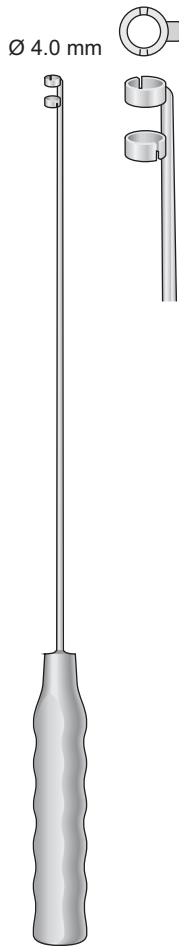

FISCHER
FO-235
310 mm

Sehnenflechtklappen - Tendon Interlacing Forceps
Pinze per intrecciare tendini - Pinzas para entrelazar tendones
Pinces pour entrelacer les tendons

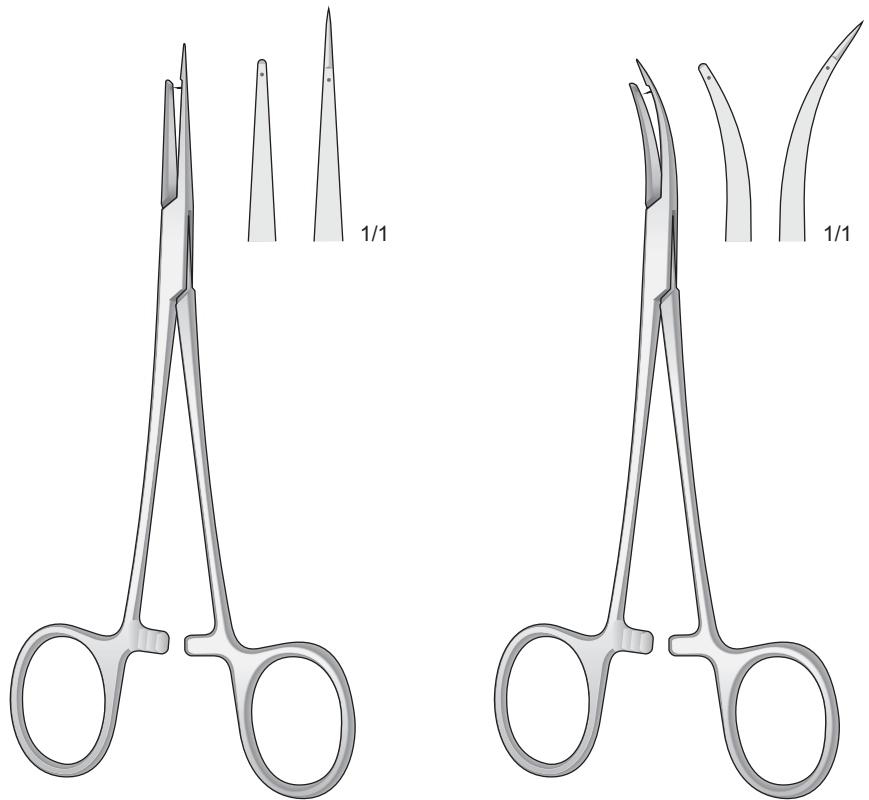

FO-208
150 mm

FO-209
150 mm

Rohrschaft. Mikro-Faßzängchen - Micro ear forceps with tubular shaft

Mikro-Löffelzängchen
Micro cup shaped forceps
Micro pinze a cucchiaio

Mikro-Scheren
Micro scissors
Micro forbici

0,9 x 1,0 mm

○
Oval
Ovale
Ovales



DB-86
Gerade - Straight
Diritta - Recta
Droit



BELLUCCI
DB-106
Gerade
Straight
Diritta
Recta
Droit

0,9 x 1,0 mm

○
Oval
Ovale
Ovales



DB-87
Nach Oben Gebogen
Curved up
Curva in alto



BELLUCCI
DB-92
Nach Oben Gebogen
Curved up
Curva in alto

0,8 x 1,3 mm

○
Oval
Ovale
Ovales



WULLSTEIN
DB-88
Gerade - Straight
Diritta - Recta
Droit



BELLUCCI
DB-93
Links Gebogen
Curved to left
Curva a sinistra
Curvas a la izquierda
Courbes à gauche

0,8 x 1,3 mm

○
Oval
Ovale
Ovales



WULLSTEIN
DB-89
Links Gebogen - Curved to left
Curva a sinistra - Curvas a la izquierda
Courbes à gauche



BELLUCCI
DB-94
Rechts Gebogen
Curved to right
Curva a destra
Curvas a la derecha
Courbes à droite

0,8 x 1,3 mm

○
Oval
Ovale
Ovales



WULLSTEIN
DB-90
Rechts Gebogen - Curved to right
Curva a destra - Curvas a la derecha
Courbes à droite



BELLUCCI
DB-95
Orizzontale

1,0 mm

○
Rund
Round
Tonda



WULLSTEIN
DB-91
Gerade - Straight
Diritta - Recta
Droit

1,7 x 2,5 mm

○
Oval
Ovale
Ovales



WULLSTEIN
DB-107
Gerade - Straight
Diritta - Recta
Droit

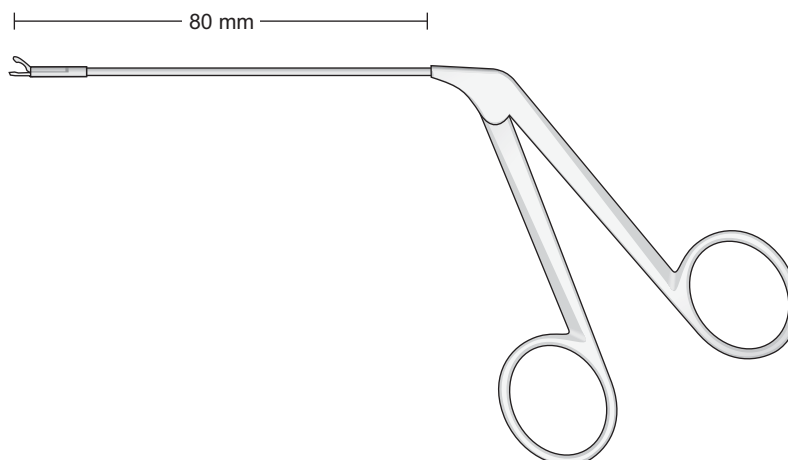

DB-86/DB-107
80 mm

0,6 x 0,5 mm



DB-201
Gerade
Straight
Diritta
Recta
Droit

0,9 x 1,1 mm



DB-205
Gerade
Straight
Diritta
Recta
Droit

0,6 x 0,5 mm



DB-202
Links Gebogen
Curved to left
Curva a sinistra
Curvas a la izquierda
Courbes à gauche

0,9 x 1,1 mm



DB-206
Links Gebogen
Curved to left
Curva a sinistra
Curvas a la izquierda
Courbes à gauche

0,6 x 0,5 mm



DB-203
Rechts Gebogen
Curved to right
Curva a destra
Curvas a la derecha
Courbes à droite

0,9 x 1,1 mm



DB-207
Rechts Gebogen
Curved to right
Curva a destra
Curvas a la derecha
Courbes à droite

0,6 x 0,5 mm



DB-204
Nach Oben Gebogen
Curved up
Curva in alto

0,9 x 1,1 mm



DB-208
Nach Oben Gebogen
Curved up
Curva in alto

0,9 x 1,1 mm



DB-209
Nach Unten Gebogen
Curved down
Curva in basso

Schaft zerlegbar
Dismantable shaft
Asta smontabile
Vástago desmontable
Tige démontable

80 mm

Superfein
Extremely delicate
Modello super fine
Superfina
Modèle superfin

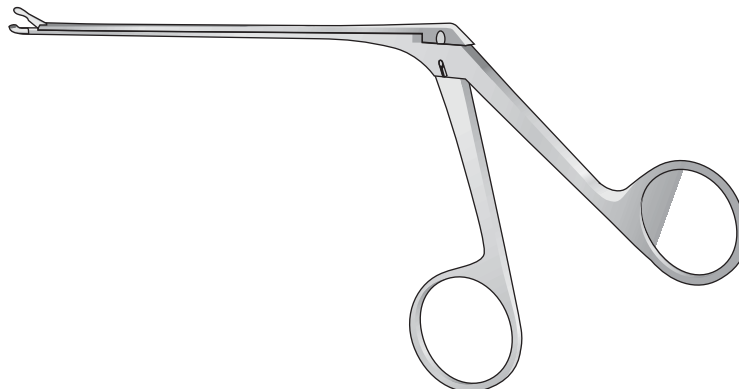

DB-201/DB-209
80 mm

6,0 x 0,8 mm



SCHUKNECHT

DB-213
 Gerade
 Straight
 Diritta
 Recta
 Droit

4,0 x 0,5 mm

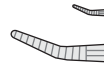
**DB-216**
 Rechts Gebogen
 Curved to right
 Curva a destra
 Curvas a la derecha
 Courbes à droite

5,0 x 0,8 mm



GREVEN

DB-214
 Gerade
 Straight
 Diritta
 Recta
 Droit

4,0 x 0,5 mm

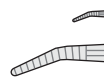
**DB-217**
 Links Gebogen
 Curved to left
 Curva a sinistra
 Curvas a la izquierda
 Courbes à gauche

4,0 x 0,5 mm

**DB-215**
 Gerade
 Straight
 Diritta
 Recta
 Droit

4,0 x 0,5 mm

**DB-218**
 Nach Oben Gebogen
 Curved up
 Curva in alto

4,0 x 0,5 mm

**DB-100**
 Glattes Maul
 Smooth jaws
 Morso liscio
 Mandibula lisa
 Mors lisses

4,0 x 0,5 mm

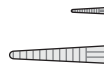
**DB-219**
 Nach Unten Gebogen
 Curved down
 Curva in basso

 Schaft zerlegbar
 Dismantable shaft
 Asta smontabile
 Vástago desmontable
 Tige démontable

 Superfein
 Extremely delicate
 Modello super fine
 Superfina
 Modèle superfin

80 mm

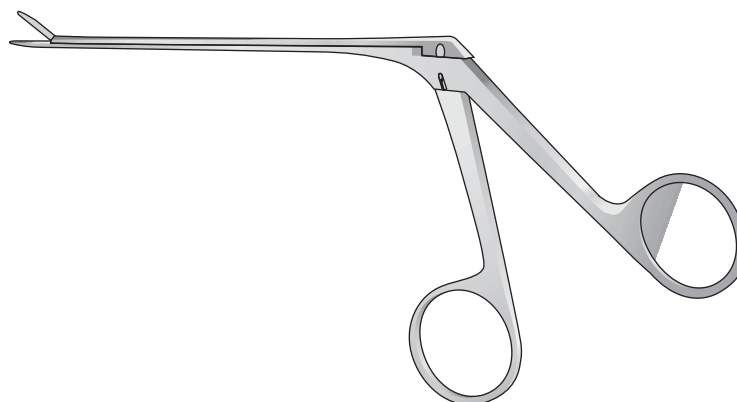
DB-100/DB-219
 80 mm

Rohrschaft. Mikro-Faßzängchen
Micro ear forceps with tubular shaft

0,8 x 3,5 mm



DB-220
Gerade
Straight
Diritta
Recta
Droit

0,8 x 3,5 mm



DB-223
65° Nach Oben Gebogen
Curved up 65°
Curva in alto 65°

1,0 x 5,0 mm



DB-221
Gerade
Straight
Diritta
Recta
Droit

0,8 x 3,5 mm



DB-224
45° Nach Unter Gebogen
Curved down 45°
Curva in basso 45°

1,5 x 6,0 mm



DB-222
Gerade
Straight
Diritta
Recta
Droit

1,0 x 5,0 mm



DB-225
Links Gebogen
Curved to left
Curva a sinistra
Curvas a la izquierda
Courbes à gauche

1,0 x 5,0 mm



DB-226
Rechts Gebogen
Curved to right
Curva a destra
Curvas a la derecha
Courbes à droite

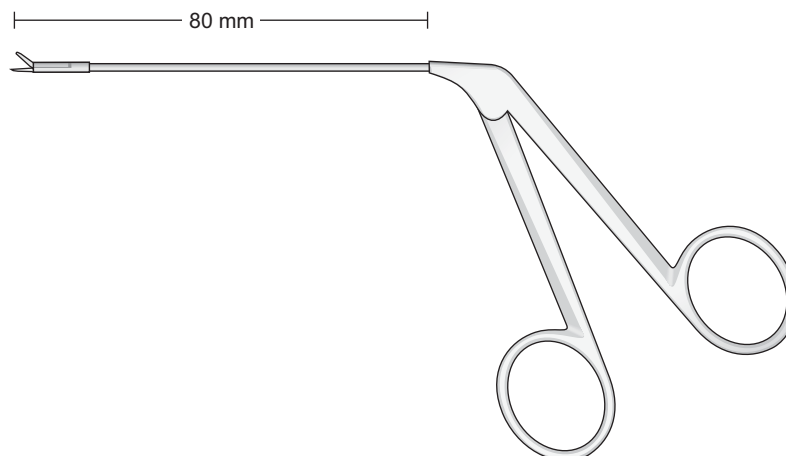

DB-220/DB-226
80 mm

**FF-450**

Gerade
Straight
Rette
Rectas
Droits

**FF-451**

Gerade, horizontal schneidend
Straight, horizontally cutting
Rette, taglio orizzontale
Rectas, de corte horizontal
Droits, à coupe horizontale

**FF-452**

Nach links gebogen
Curved to left
Curve a sinistra
Acodadas hacia la izquierda
Courbes à gauche

**FF-453**

Nach rechts gebogen
Curved to right
Curve a destra
Acodadas hacia la derecha
Courbes à droite

**FF-454**

Nach oben abgewinkelt
Angled up
Angolate in alto
Angulada hacia arriba
Coudés vers le haut

**FF-455**

Nach unten abgewinkelt
Angled down
Angolate in basso
Angulada hacia abajo
Coudés vers le bas

**FF-456**

Gerefties mau, gerade
Serrated jaws, straight
Morsi zigrinati, retti
Boca estriada, recta
Mors striés, droits

**FF-457**

Gerefties mau, rechts gebogen
Serrated jaws, right
Morsi zigrinati, curvi a destra
Boca estriada, curva a la derecha
Mors striés, courbes à droite

**FF-458**

Gerefties mau, links gebogen
Serrated jaws, left
Morsi zigrinati, curvi a sinistra
Boca estriada, curva a la izquierda
Mors striés, courbes à gauche

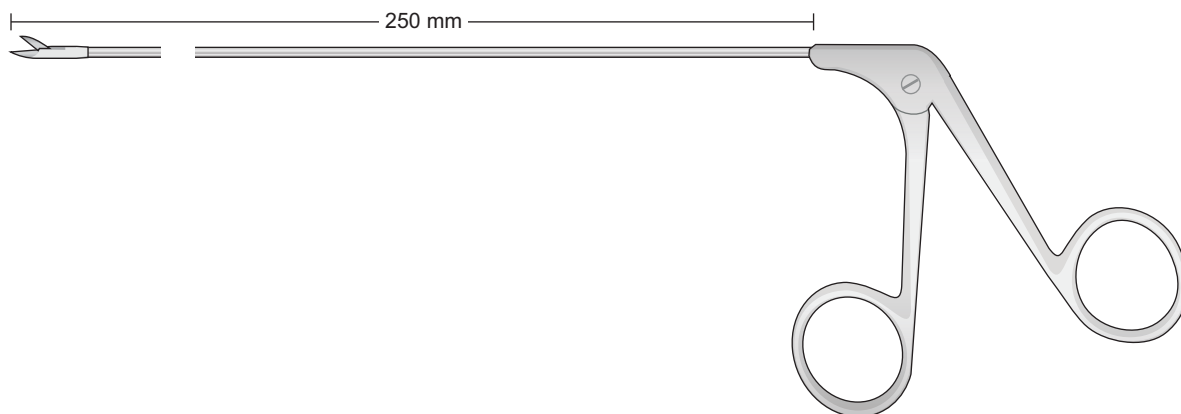

FF-450/FF-458
250 mm

**FF-459**

Rundes Löffelmaul, gerade
Round cup jaws, straight
Morso a forma di cucchiaio rotondo, retto
Boca redonda en forma de cucharilla, recta
Mors ronds en cuiller, droits

**FF-460**

Rundes Löffelmaul, nach oben
Round cup jaws, up
Morso a forma di cucchiaio rotondo, in alto
Boca redonda en forma de cucharilla, arriba
Mors ronds en cuiller, courbes en haut

**FF-461**

Rundes Löffelmaul, rechts
Round cup jaws, right
Morso a forma di cucchiaio rotondo, destra
Boca redonda en forma de cucharilla, a la derecha
Mors ronds en cuiller, courbes à droite

**FF-462**

Rundes Löffelmaul, links
Round cup jaws, left
Morso a forma di cucchiaio rotondo, sinistra
Boca redonda en forma de cucharilla, a la izquierda
Mors ronds en cuiller, courbes à gauche

**FF-463**

Ovales Löffelmaul, gerade
Oval cup jaws, straight
Morso a forma di cucchiaio ovale, retto
Boca ovalada en forma de cucharilla, recta
Mors ovales en cuiller, droits

**FF-464**

Ovales Löffelmaul, nach oben
Oval cup jaws, up
Morso a forma di cucchiaio ovale, in alto
Boca ovalada en forma de cucharilla, arriba
Mors ovales en cuiller, courbes en haut

**FF-465**

Ovales Löffelmaul, rechts
Oval cup jaws, right
Morso a forma di cucchiaio ovale, destra
Boca ovalada en forma de cucharilla, a la derecha
Mors ovales en cuiller, courbes à droite

**FF-466**

Ovales Löffelmaul, links
Oval cup jaws, left
Morso a forma di cucchiaio ovale, sinistra
Boca ovalada en forma de cucharilla, a la izquierda
Mors ovales en cuiller, courbes à gauche

**FF-467**

Ovales Löffelmaul, gerade
Oval cup jaws, straight
Morso a forma di cucchiaio ovale, retto
Boca ovalada en forma de cucharilla, recta
Mors ovales en cuiller, droits

**FF-468**

Maulteile gefenstert
Jaw fenestrated
Morso fenestrato
Boca fenestrada
Mors ajourés

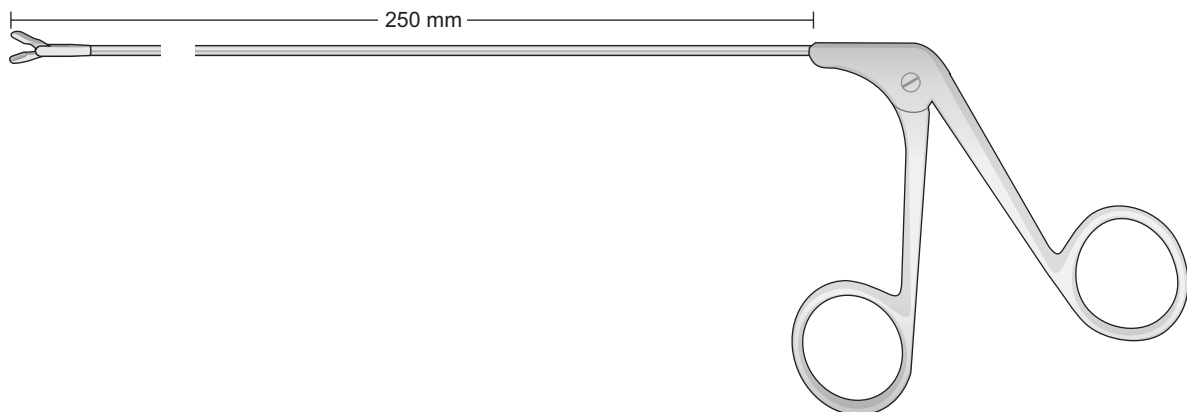

FF-459/FF-468
250 mm

Gerade
Stright
Diritta
Rectas
Droites

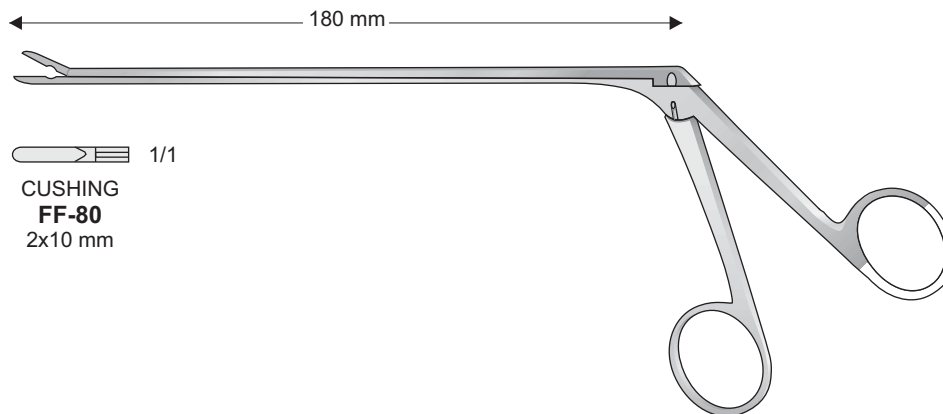

1/1
CUSHING
FF-80
2x10 mm

CUSHING
FF-80

Aufwärtsgebogen
Top curved
Curva verso l'alto
Curvos
Courbe vers le haut

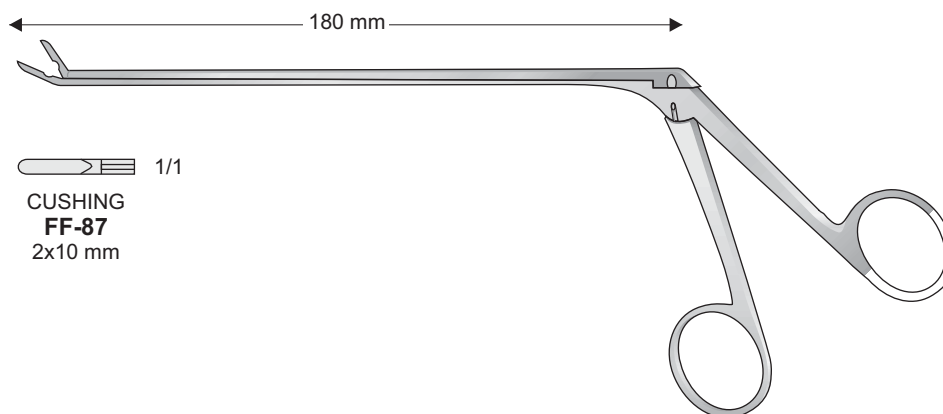

1/1
CUSHING
FF-87
2x10 mm

CUSHING
FF-87

Abwärts gebogen
Bottom curved
Curva verso il basso
Curvos
Courbe vers le bas

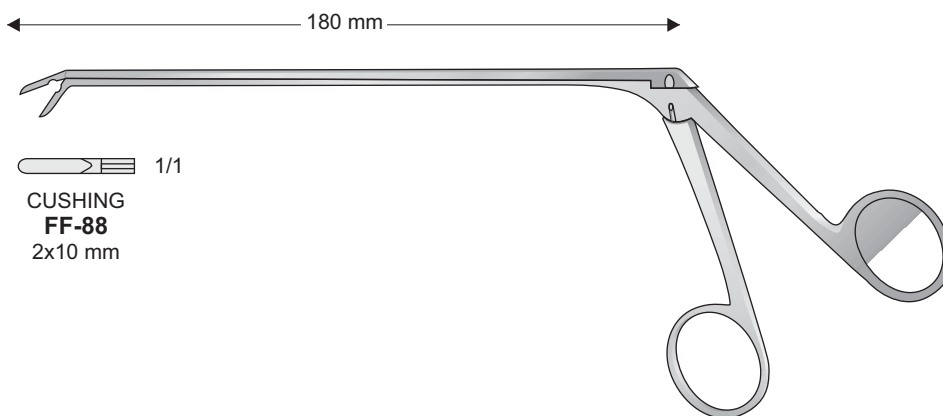

1/1
CUSHING
FF-88
2x10 mm

CUSHING
FF-88

Ø 1,2 mm

Katheter-Einführungsinstrumente
Catheter introducing instruments
Strumenti per tendere ed introdurre i cateteri
Instrumentos para introducir catéteres
Mandrin pour introduire les sondes

Endospekula für Harnröhre und
Cervix, ohne Sperre
Endospecula for cervix and urethra,
without ratchet

Endospekula für Harnröhre und
Cervix, mit Skalensperre und Fixierschraube
Endospecula for cervix and urethra,
with scale-ratchet and fixing screws
Con cremagliera a scala e vite di fissaggio
Con cremallera graduada y tornillo de fijación
Avec crémaillère à échelle et vis à fixation

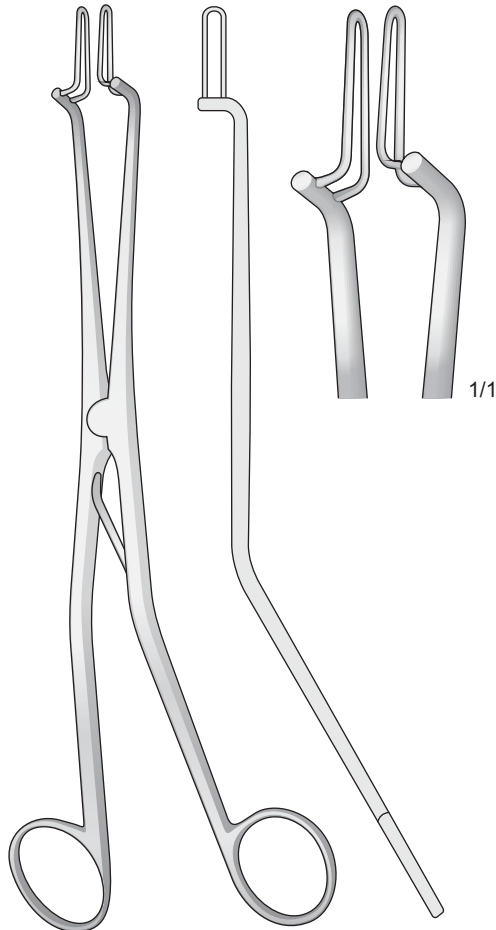

KOGAN
EB-110
240 mm

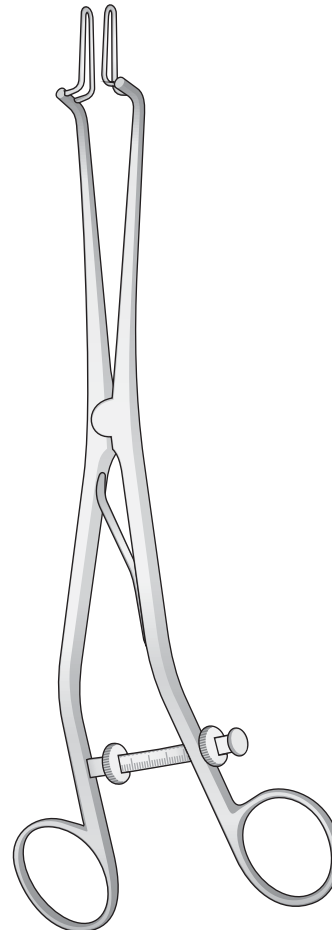

KOGAN
EB-111
240 mm

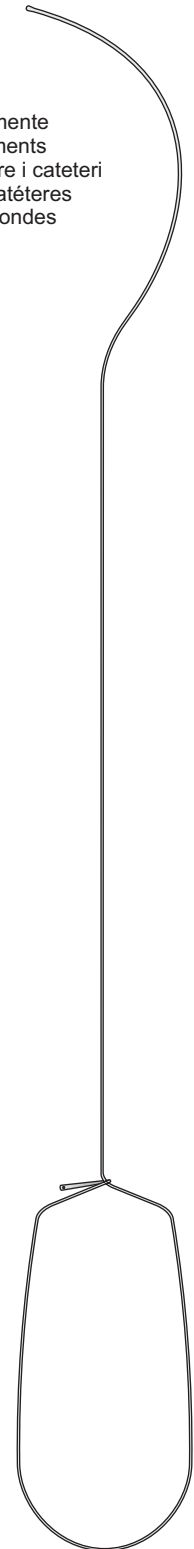

EA-94
425 mm

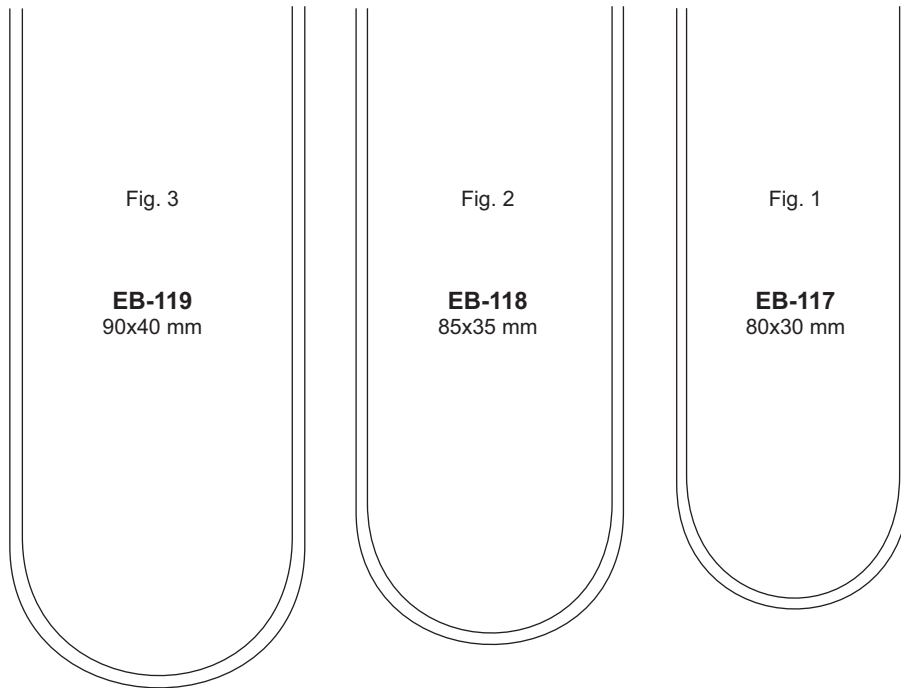

Fig. 3

EB-119
90x40 mm

Fig. 2

EB-118
85x35 mm

Fig. 1

EB-117
80x30 mm

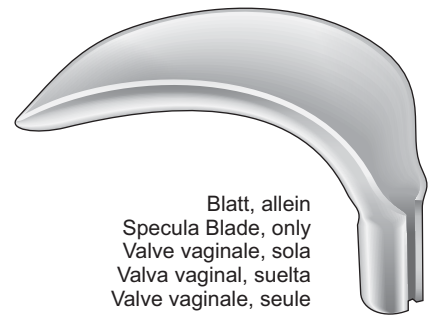

Blatt, allein
Specula Blade, only
Valve vaginale, sola
Valva vaginal, suelta
Valve vaginale, seule

SCHERBAK
EB-117/EB-119

Blasenhalsperrer
Sounds Bladder
Dilatatore del collo vescicale
Sonda vesicales
Dilatateur pour le col vésical

Biopsiekürette
Uterine Biopsy Curette
Curette per biopsia
Curetts para biopsia
Curettes pour biopsie

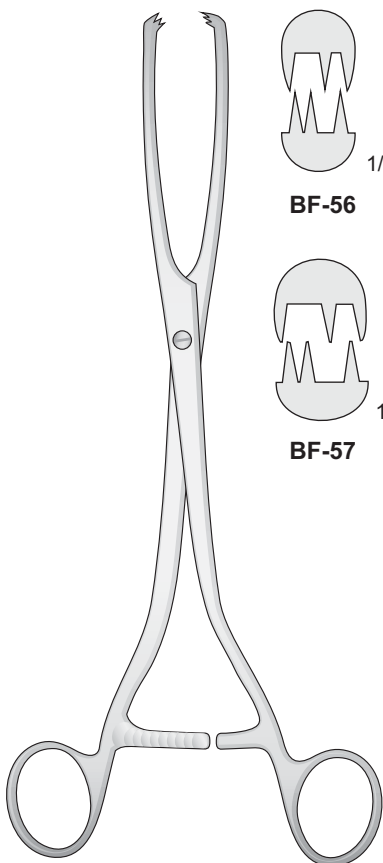

BF-56

BF-57

MUSEUX
BF-56/BF-57
265 mm

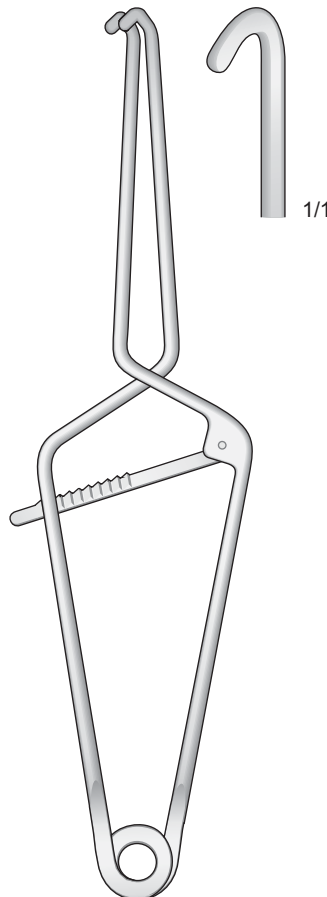

MILLIN
EB-17
280 mm

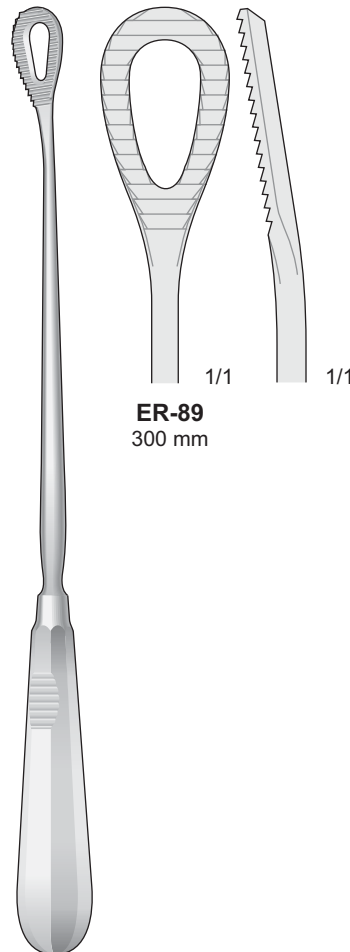

ER-89
300 mm

PESTALOZZA
ER-89
300 mm



KEVORKIAN
ER-87
300 mm

Gewicht zum Vaginalspekulum
Weight for Vaginal Speculum
Peso per specolo vaginale
Peso para espéculo vaginal
Poids pour spéculum vaginal

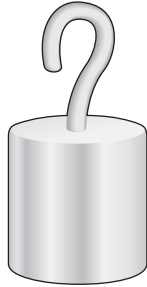

SCHERBAK
EB-294 10,5 mm 400 gr
EB-295 13 mm 800 gr

Blatt, allein
Specula Blade, only
Valve vaginale, sola
Valva vaginal, suelta
Valve vaginale, seule



SCHERBAK
EB-291/EB-292

Griff zum Vaginalspekulum
Handle for Vaginal Speculum
Manico per specolo vaginale
Mango para espéculo vaginal
Manche pour spéculum vaginal



SCHERBAK
EB-293
200 mm

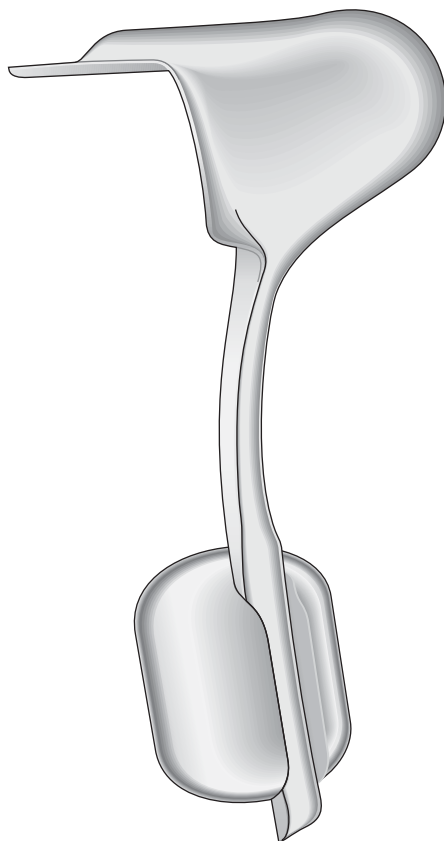

AUVARD
EB-290
230 mm

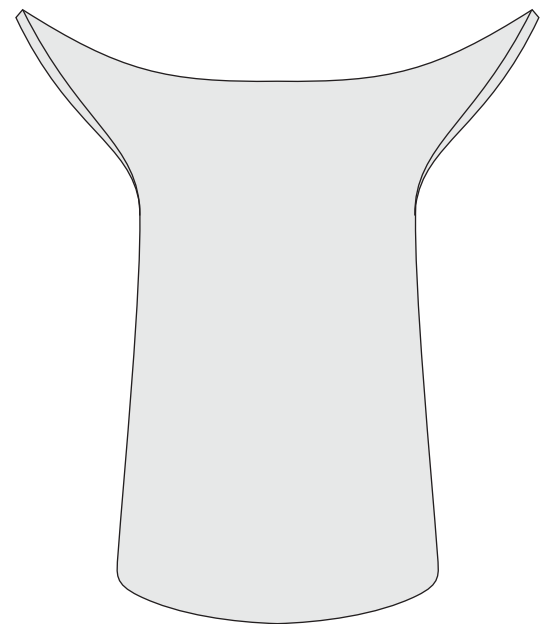

EB-292
81x45 - 70 mm

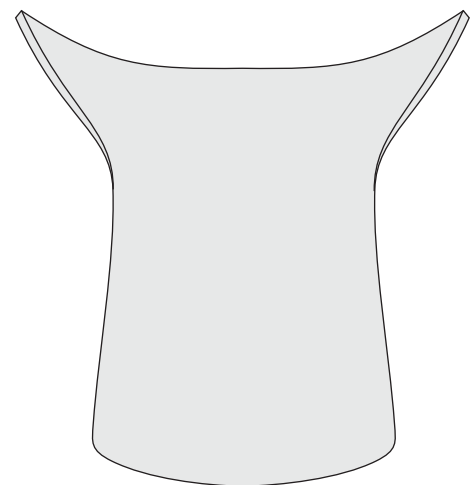

EB-291
62x40 - 60 mm

Geschwärzt
 Surface Black-finish
 Superficie anti-riflesso
 Surface noircie



ER-58
 75 x 20 mm



ER-59
 100 x 22 mm



ER-60
 120 x 25 mm

EB-94

Komplettsset mit 14 Uterusdilatoren ohne Metalletui
Set con 14 dilatatori uterini senza scatola

**EB-95**

Komplettsset mit 26 Uterusdilatoren ohne Metalletui
Set con 26 dilatatori uterini senza scatola

**EB-96**

Metalletui mit 14 Hegar Uterusdilatoren
Scatola con 14 dilatatori uterini Hegar

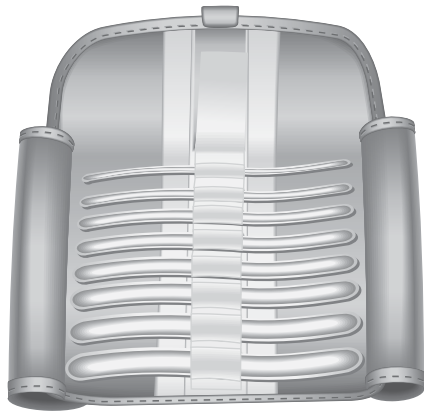
**ER-134**

Metalletui mit 13 Hegar Uterusdilatoren
Scatola con 13 dilatatori uterini Hegar

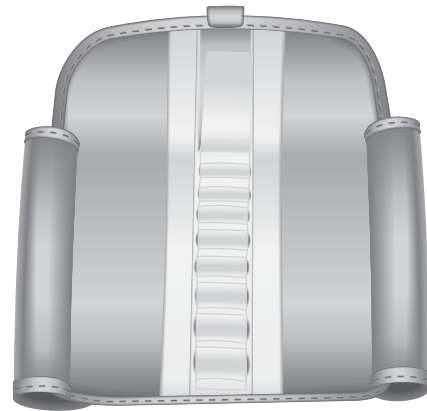
**ER-133**

mit 8 Uterusdilatoren
con 8 dilatatori uterini

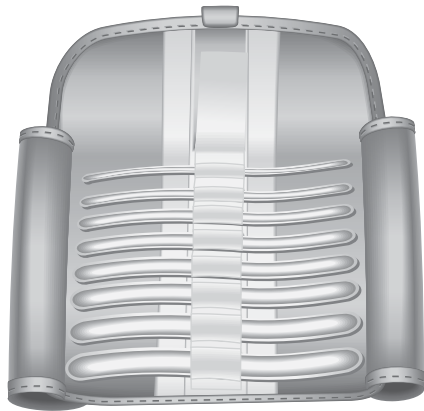
**ER-135**

für 8 Uterusdilatoren
per 8 dilatatori uterini

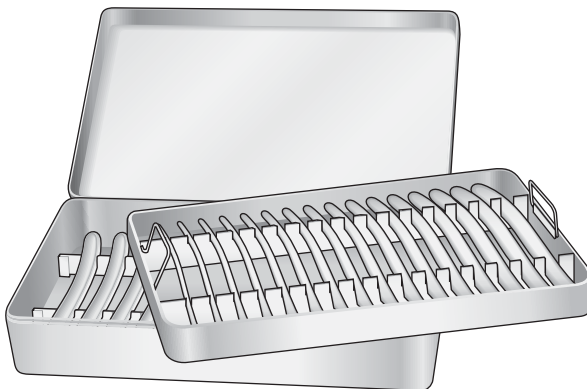
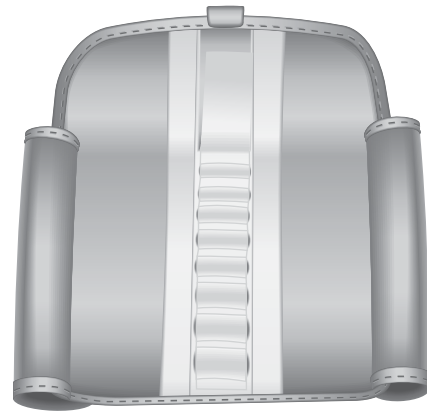
**EB-97**

Metalletui mit 26 Hegar Uterusdilatoren
Scatola con 26 dilatatori uterini Hegar

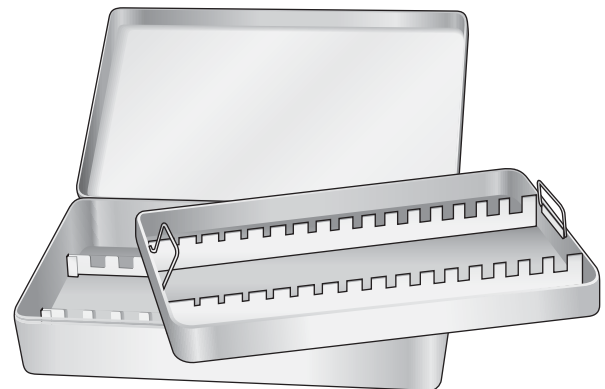
**BS-17**

Metalletui leer für 26 Hegar Uterusdilatoren
Scatola vuota per 26 dilatatori uterini Hegar

Uterusdepressor
 Uterine Depressor
 Depressore uterino
 Depresor uterino
 D3presseur ut3rin



BRAUN
ER-76
 275 mm

Sterilisierzangen zum Fassen und
 Halten Steriler Instrumente
 Sterilizing forceps for picking
 up and holding of sterile instruments
 Pinze per prelevare strumenti sterilizzati
 Pinzas para esterilizaci3n
 Pincas pour instruments st3rilis3s

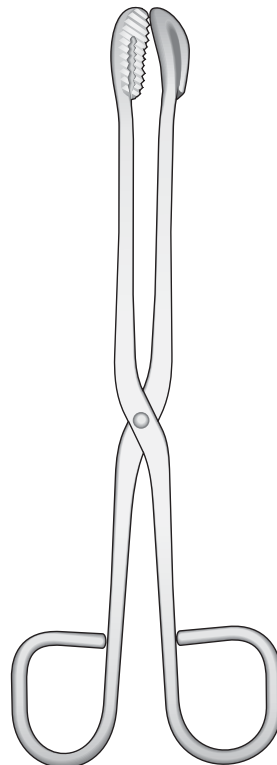

GS-13 200 mm
GS-14 300 mm

Pinza per rimozione
 punti metallici

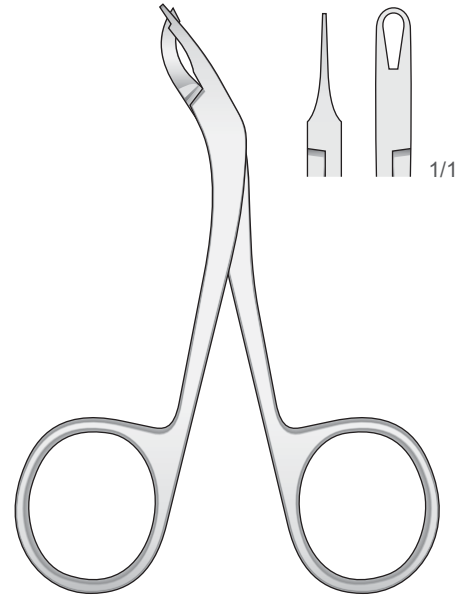

BF-64
 115 mm

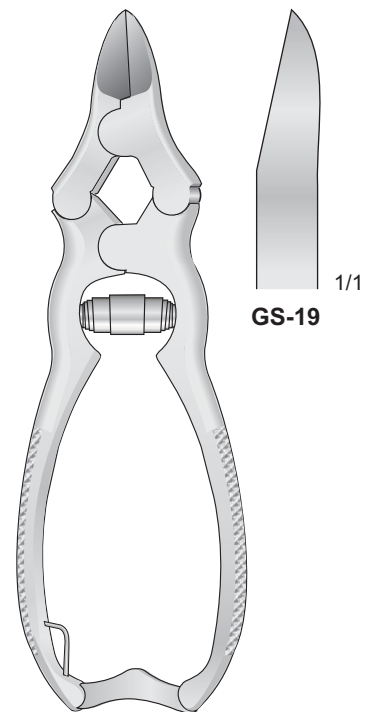

GS-19
 155 mm

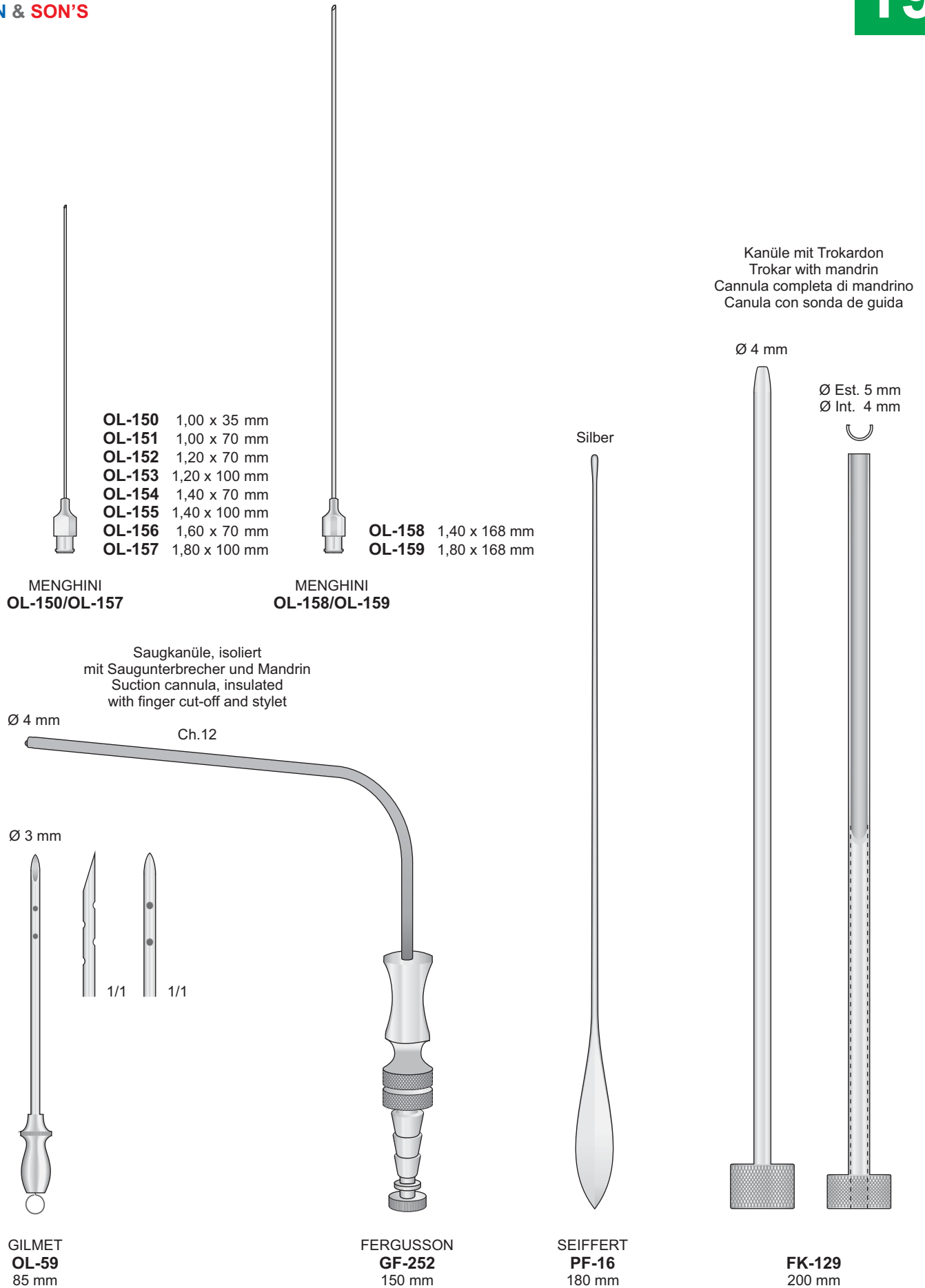

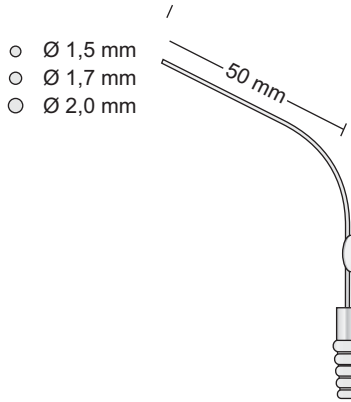

BARNES
GF-253/GF-255
100 mm

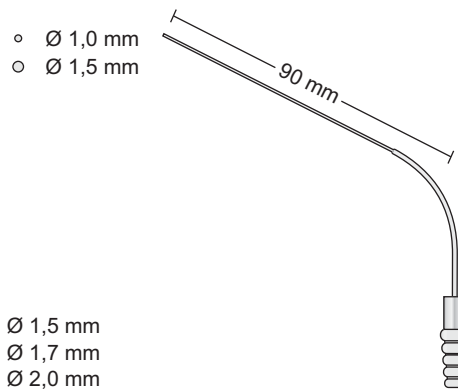

BARNES
GF-265/GF-266
125 mm

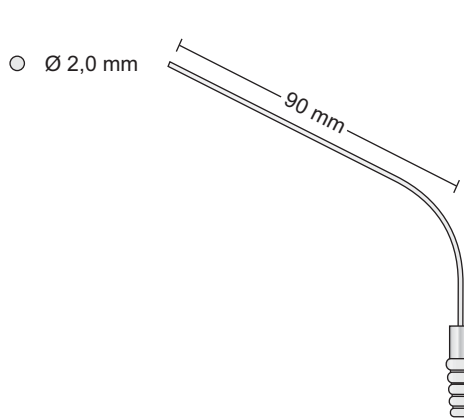

BARNES
GF-267
125 mm

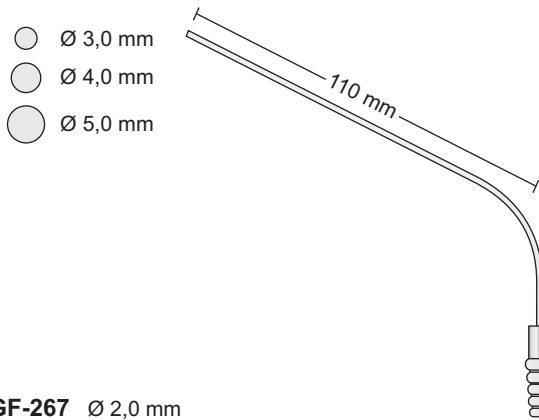

BARNES
GF-268/GF-270
150 mm

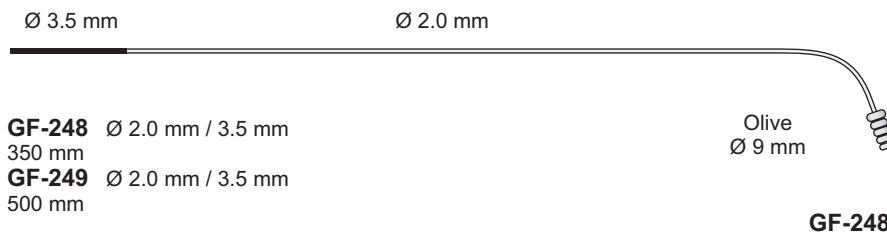

GF-248 Ø 2.0 mm / 3.5 mm
 350 mm
GF-249 Ø 2.0 mm / 3.5 mm
 500 mm

GF-248/GF-249

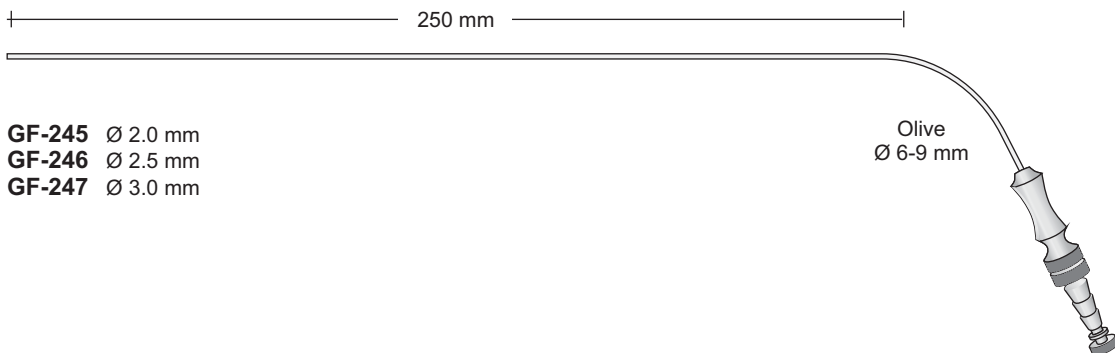

GF-245 Ø 2.0 mm
GF-246 Ø 2.5 mm
GF-247 Ø 3.0 mm

GF-245/GF-247
250 mm

Lunghezza Cannula	No.1 0,6 x 0,4	No.2 0,8 x 0,6	No.3 1,0 x 0,8	No.4 1,2 x 1,0	No.5 1,5 x 1,2	No.6 2,0 x 1,6	
SS = 80 mm	GF-301	GF-302	GF-303	GF-304	GF-305	GF-306	For Bypass
S = 100 mm	GF-307	GF-308	GF-309	GF-310	GF-311	GF-312	
M = 120 mm	GF-313	GF-314	GF-315	GF-316	GF-317	GF-318	
L = 145 mm	GF-319	GF-320	GF-321	GF-322	GF-323	GF-324	
LL = 160 mm	GF-325	GF-326	GF-327	GF-328	GF-329	GF-330	For Trans-sphenoidal
LLL = 175 mm	GF-331	GF-332	GF-333	GF-334	GF-335	GF-336	For Trans-sphenoidal

Char. 1	= 0,3 mm
Char. 2	= 0,6 mm
Char. 3	= 1,0 mm
Char. 4	= 1,3 mm
Char. 5	= 1,6 mm
Char. 6	= 2,0 mm
Char. 7	= 2,3 mm
Char. 8	= 2,6 mm
Char. 9	= 3,0 mm
Char. 10	= 3,3 mm

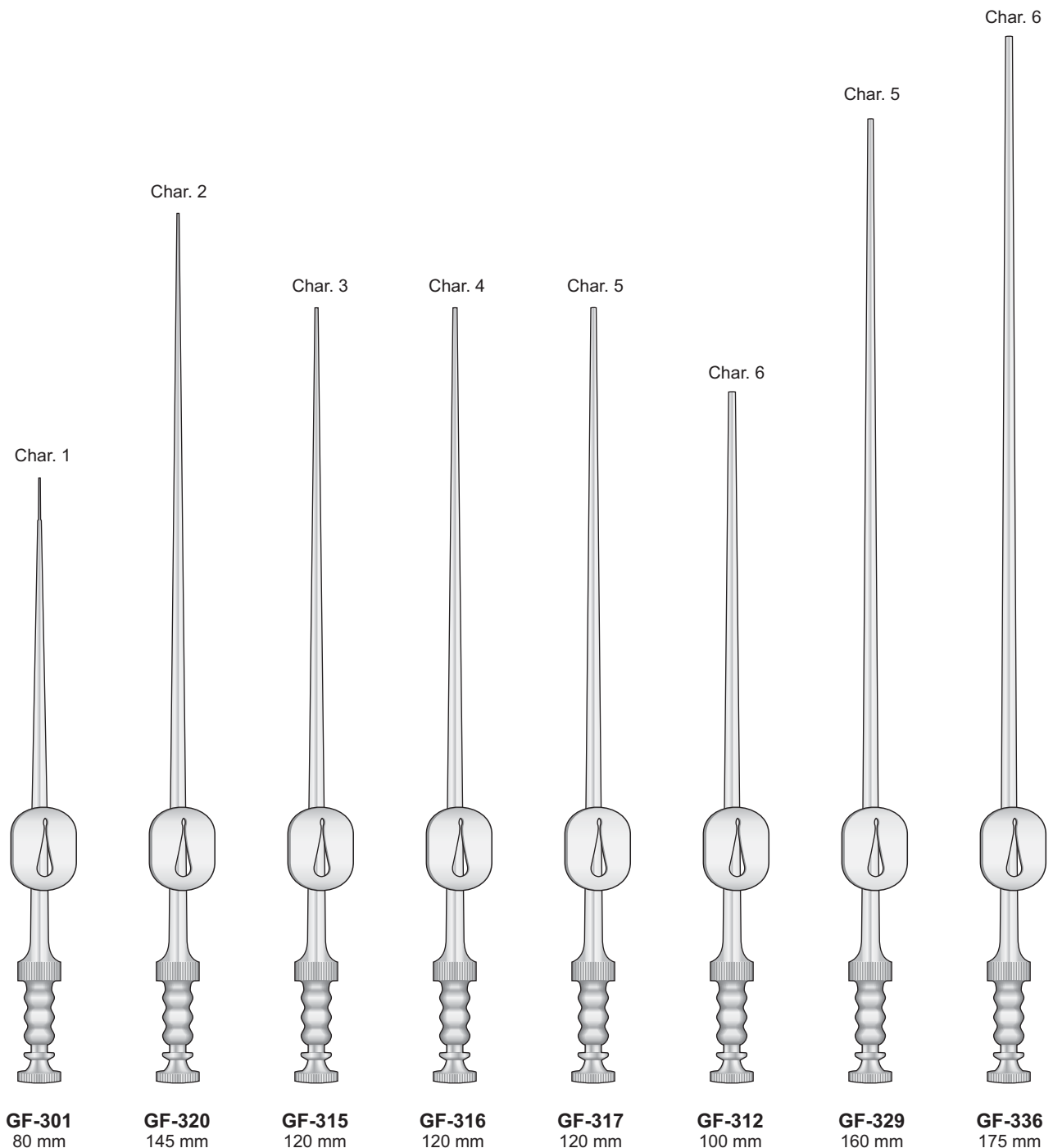

Lunghezza Cannula	No.7 2,5 x 1,9	No.8 3,0 x 2,2	No.9 3,5 x 2,5	No.10 4,0 x 3,0	
M = 120 mm	GF-337	GF-338	GF-339	GF-340	
L = 145 mm	GF-341	GF-342	GF-343	GF-344	
LL = 160 mm	GF-345	GF-346	GF-347	GF-348	For Trans-sphenoidal
LLL = 175 mm	GF-349	GF-350	GF-351	GF-352	For Trans-sphenoidal

Char. 1	= 0,3 mm
Char. 2	= 0,6 mm
Char. 3	= 1,0 mm
Char. 4	= 1,3 mm
Char. 5	= 1,6 mm
Char. 6	= 2,0 mm
Char. 7	= 2,3 mm
Char. 8	= 2,6 mm
Char. 9	= 3,0 mm
Char. 10	= 3,3 mm

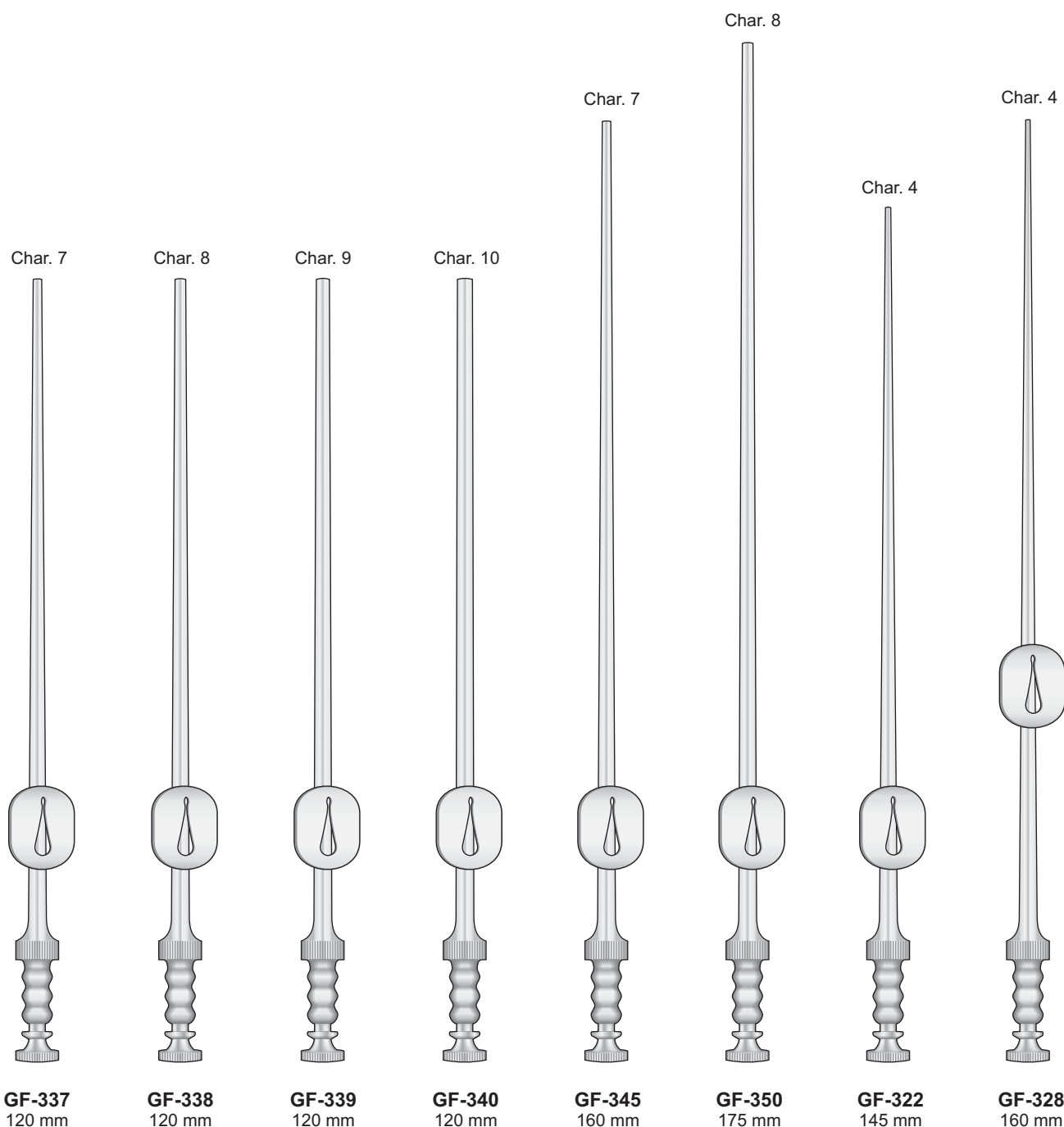

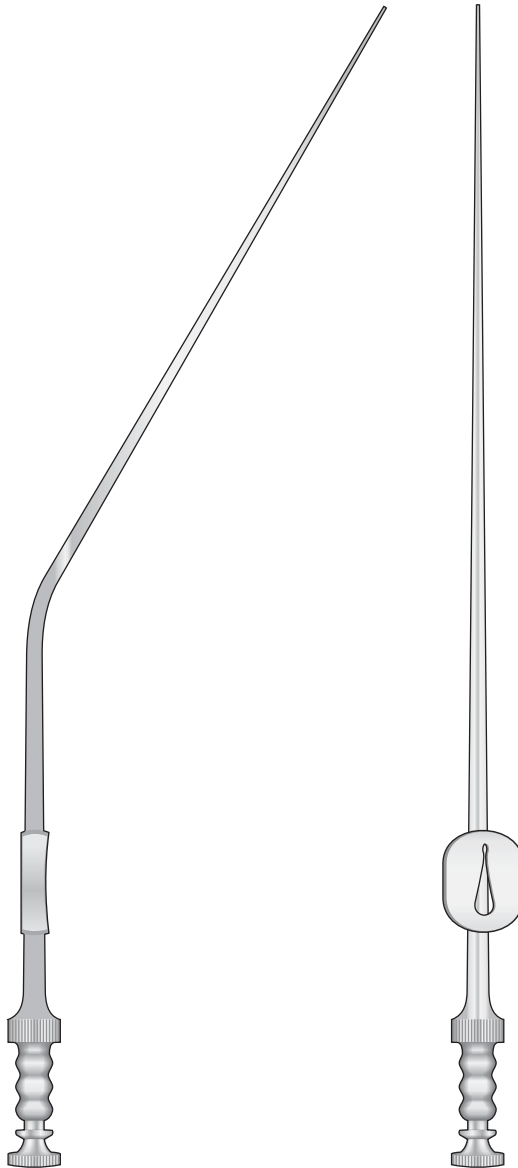

Char. 3	= 1,0 mm
Char. 4	= 1,3 mm
Char. 5	= 1,6 mm
Char. 6	= 2,0 mm
Char. 7	= 2,3 mm
Char. 8	= 2,6 mm
Char. 9	= 3,0 mm
Char. 10	= 3,3 mm
Char. 11	= 3,6 mm
Char. 12	= 4,0 mm

	Lunghezza 160 mm	Lunghezza 180 mm	Lunghezza 205 mm
Char. 3	GF-353	GF-363	GF-373
Char. 4	GF-354	GF-364	GF-374
Char. 5	GF-355	GF-365	GF-375
Char. 6	GF-356	GF-366	GF-376
Char. 7	GF-357	GF-367	GF-377
Char. 8	GF-358	GF-368	GF-378
Char. 9	GF-359	GF-369	GF-379
Char. 10	GF-360	GF-370	GF-380
Char. 11	GF-361	GF-371	GF-381
Char. 12	GF-362	GF-372	GF-382

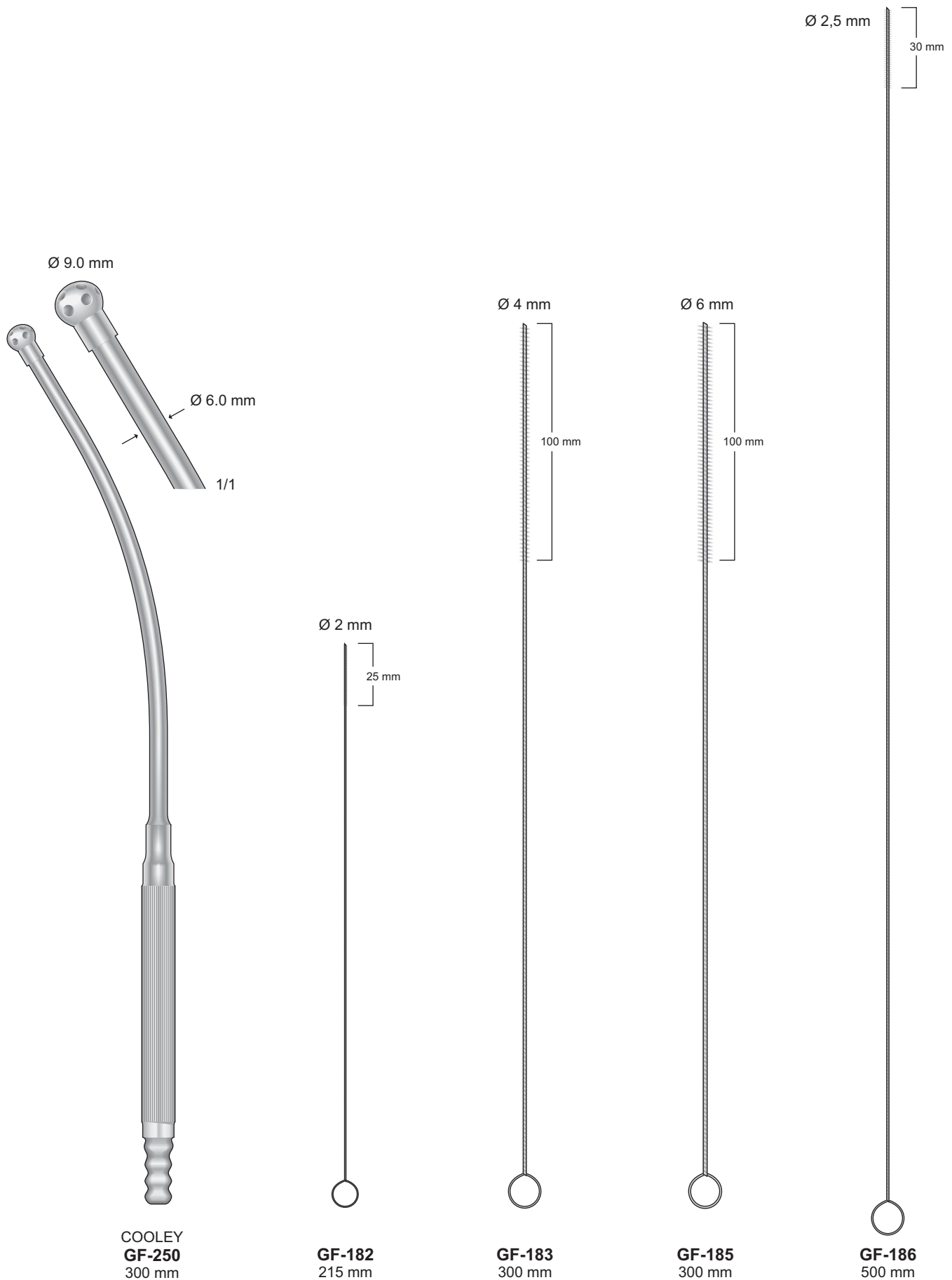

mm: Schnittlänge
Length of blades
Lunghezza della lama
Largo de hojas
Longueur de la lame

Metallheft
Metal handle
Manico in metallo
Mango metálico
Manche métal

Holzheft
Wooden handle
Manico in legno
Mango de madera
Manche bois

Metallheft
Metal handle
Manico in metallo
Mango metálico
Manche métal

Metallheft
Metal handle
Manico in metallo
Mango metálico
Manche métal

Resektionsmesser
Resection knives
Coltello per resezione
Cuchillos para resección
Couteaux à résection

Organmesser
Post mortem knives
Coltello per autopsia
Cuchillos para órganos
Couteaux à autopsie

Organmesser
Post mortem knives
Coltello per autopsia
Cuchillos para órganos
Couteaux à autopsie

Hirnmesser
Brain knives
Coltello per cervello
Cuchillos para cerebro
Couteaux à cerveau

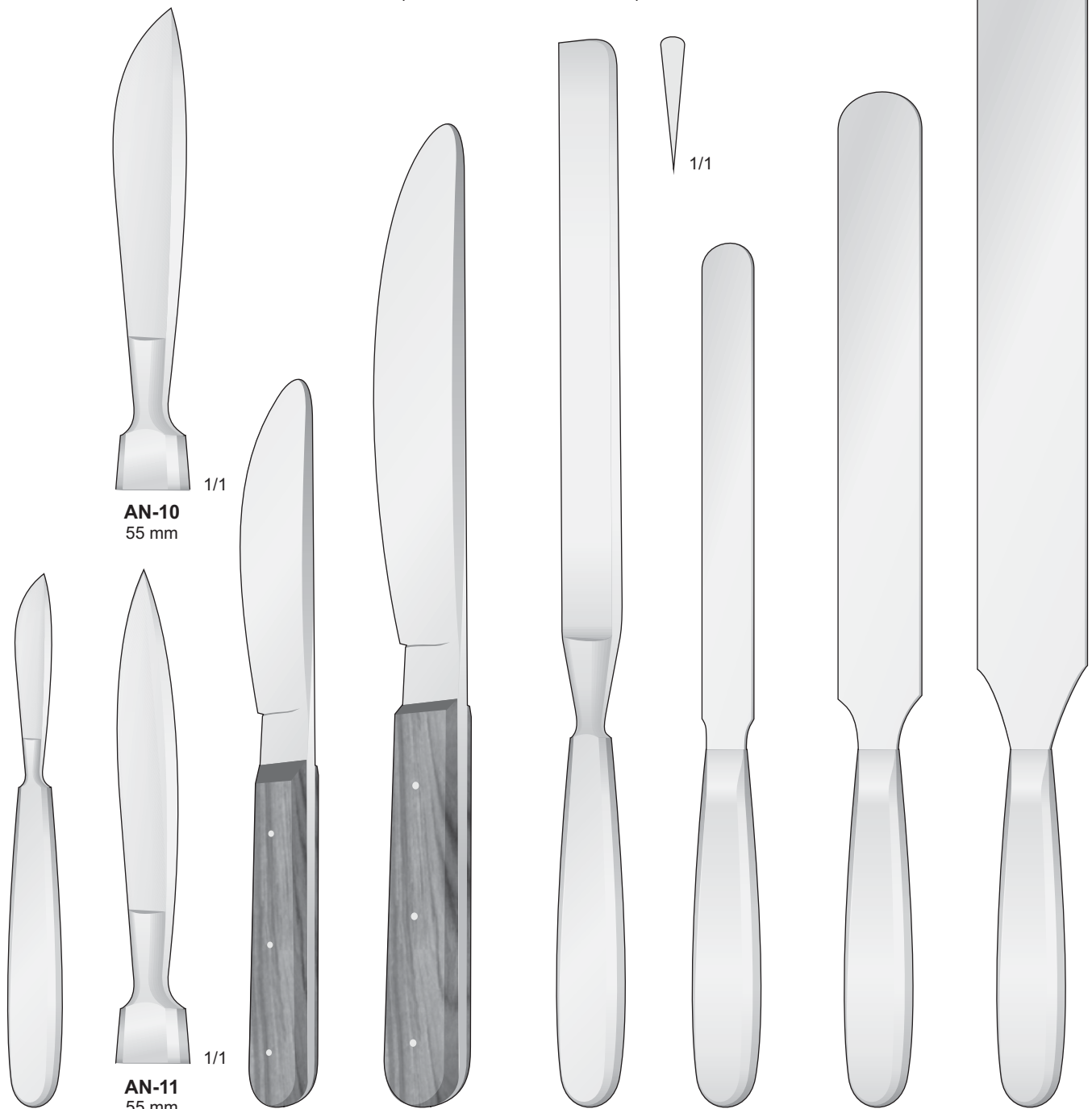

AN-10
55 mm

AN-11
55 mm

AN-12
110 mm

AN-13
170 mm

AN-14
195 mm

VIRCHOW
AN-15
160 mm

VIRCHOW
AN-16
200 mm

VIRCHOW
AN-17
240 mm

LANGENBECK
AN-10/AN-11
55 mm

Dermatome komplett mit 1 auswechselbarer Klinge und 2 Spannplatten
 Dermatome complete with 1 interchangeable blade and 2 skin plates
 Dermatomo a mano, con una lama intercambiabile, completo di 2 placche per stendere la pelle
 Dermatomo completo, con 1 hoja intercambiabile y 2 placas para extender la piel
 Dermatome avec 1 lame interchangeable et 2 plaques pour tendre la peau

Einstellbar von 0,1 bis 3,0 mm
 Adjustable from 0,1 to 3,0 mm
 Regolazione da 0,1 a 3,0 mm
 Regulable de 0,1 hasta 3,0 mm
 Réglable en épaisseur de 0,1 à 3,0 mm

Einstellbar von 0,1 bis 4,0 mm
 Adjustable from 0,1 to 4,0 mm
 Regolazione da 0,1 a 4,0 mm
 Regulable de 0,1 hasta 4,0 mm
 Réglable en épaisseur de 0,1 à 4,0 mm

Für handelsübliche Rasierklingen
 For usual razor blades
 Per lamette standard
 Para hojas de afeitar usuales
 Pour lames de rasoir modèle standard

Spanplatte
 Skin Fixing Plate
 Placca per stendere la pelle
 Placa para extender la piel
 Plaque pour tendre la peau



SCHINK
DE-10



SILVER
DE-11
190 mm

Ersatzklinge, allein
 Spare Blade only
 Lama di ricambio sola
 Hoja de repuesto
 Lame de rechange, seule



SILVER
DE-12
43 mm

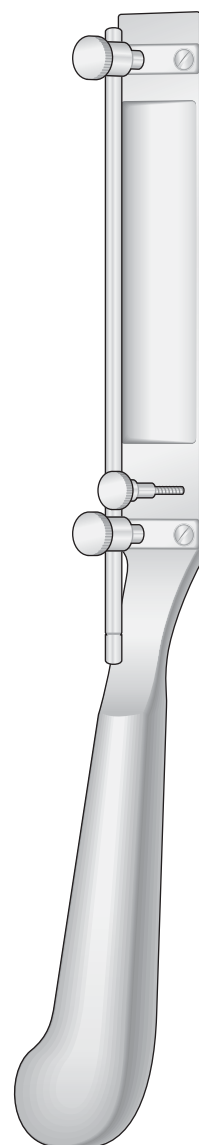

SCHINK
DE-13
300 mm

Ersatzklinge, allein
 Spare Blade only
 Lama di ricambio sola
 Hoja de repuesto
 Lame de rechange, seule



SCHINK
DE-14
102 mm

Dermatome komplett mit 1 auswechselbarer Klinge und 2 Spannplatten

Dermatome complete with 1 interchangeable blade and 2 skin plates

Dermatomo a mano, con una lama intercambiabile, completo di 2 placche per stendere la pelle

Dermatomo completo, con 1 hoja intercambiabile y 2 placas para extender la piel

Dermatome avec 1 lame interchangeable et 2 plaques pour tendre la peau

Einstellbar von 0,1 bis 1,5 mm
Adjustable from 0,1 to 1,5 mm
Regolazione da 0,1 a 1,5 mm
Regulable de 0,1 hasta 1,5 mm
Réglable en épaisseur de 0,1 à 1,5 mm

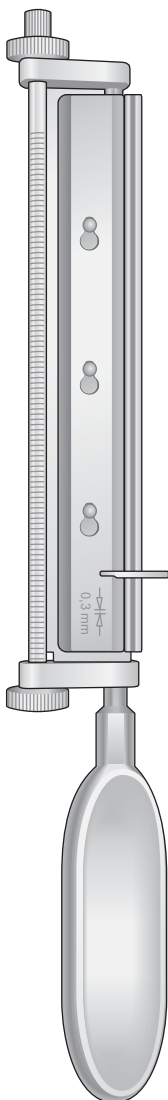

**WATSON
DE-15**
300 mm

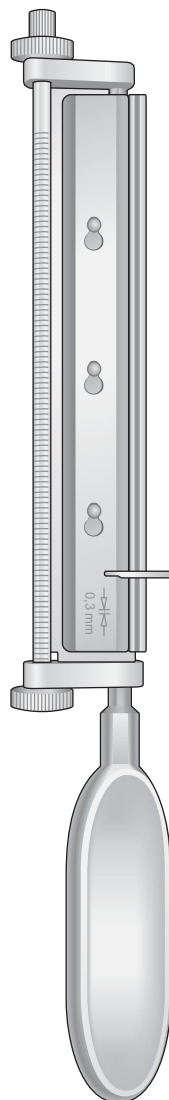

**COBBETT
DE-16**
300 mm

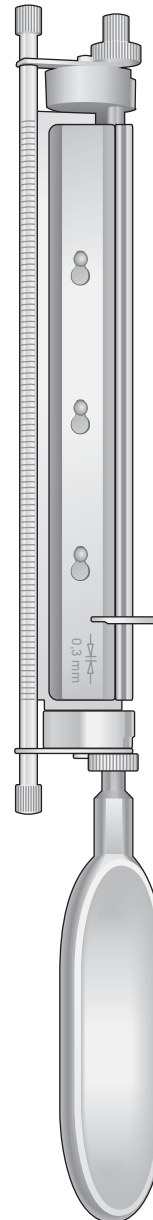

**HUMBY
DE-17**
320 mm

Ersatzklinge, allein
Spare Blade only
Lama di ricambio sola
Hoja de repuesto
Lame de rechange, seule



**HUMBY
DE-18**
157 mm

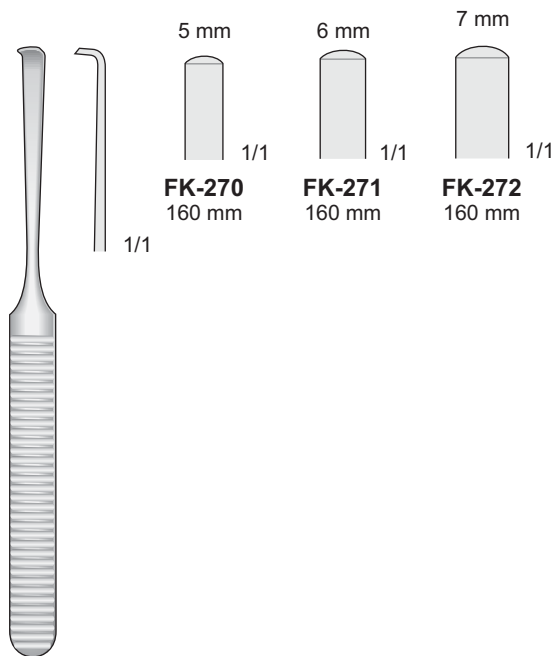

FK-270/FK-272
160 mm

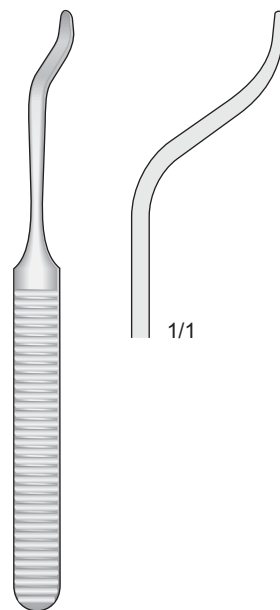

KO-78
160 mm

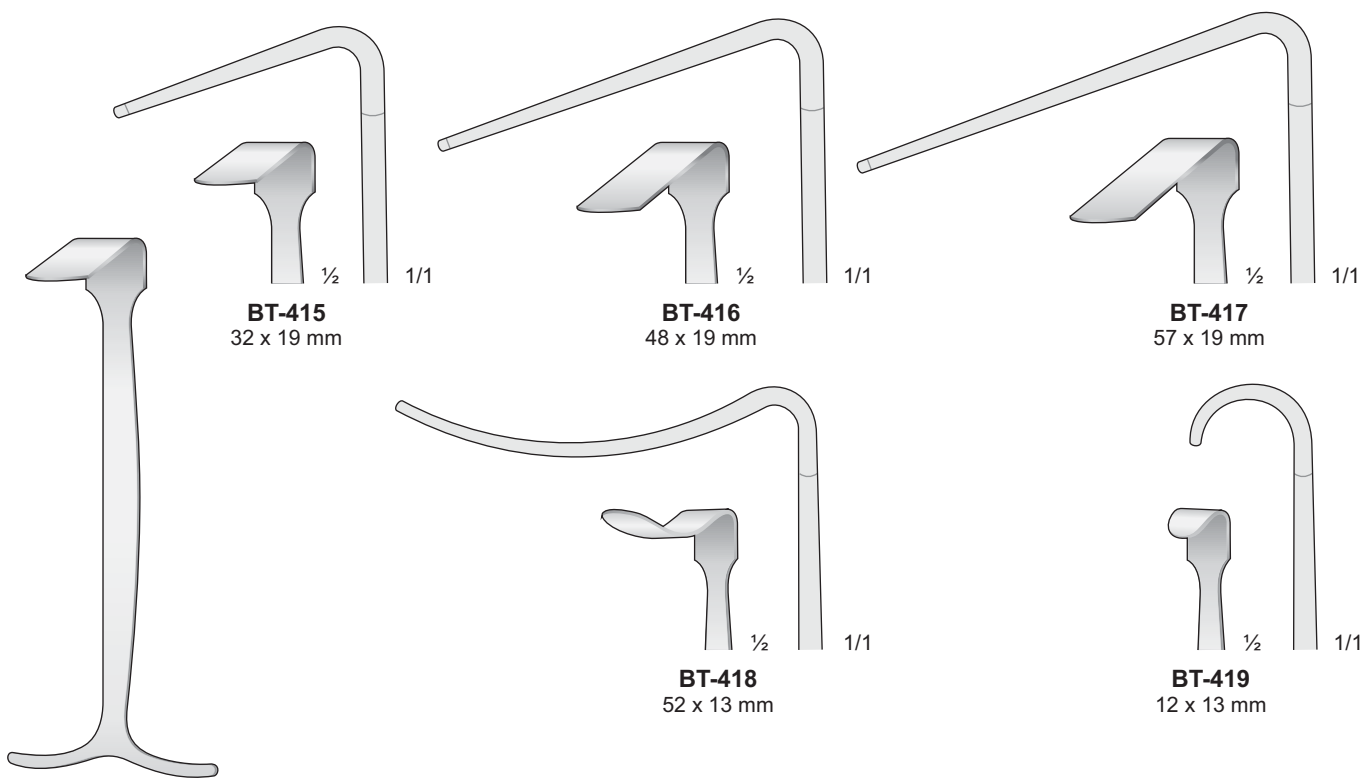

SMILLIE
BT-415/BT-419
140 mm

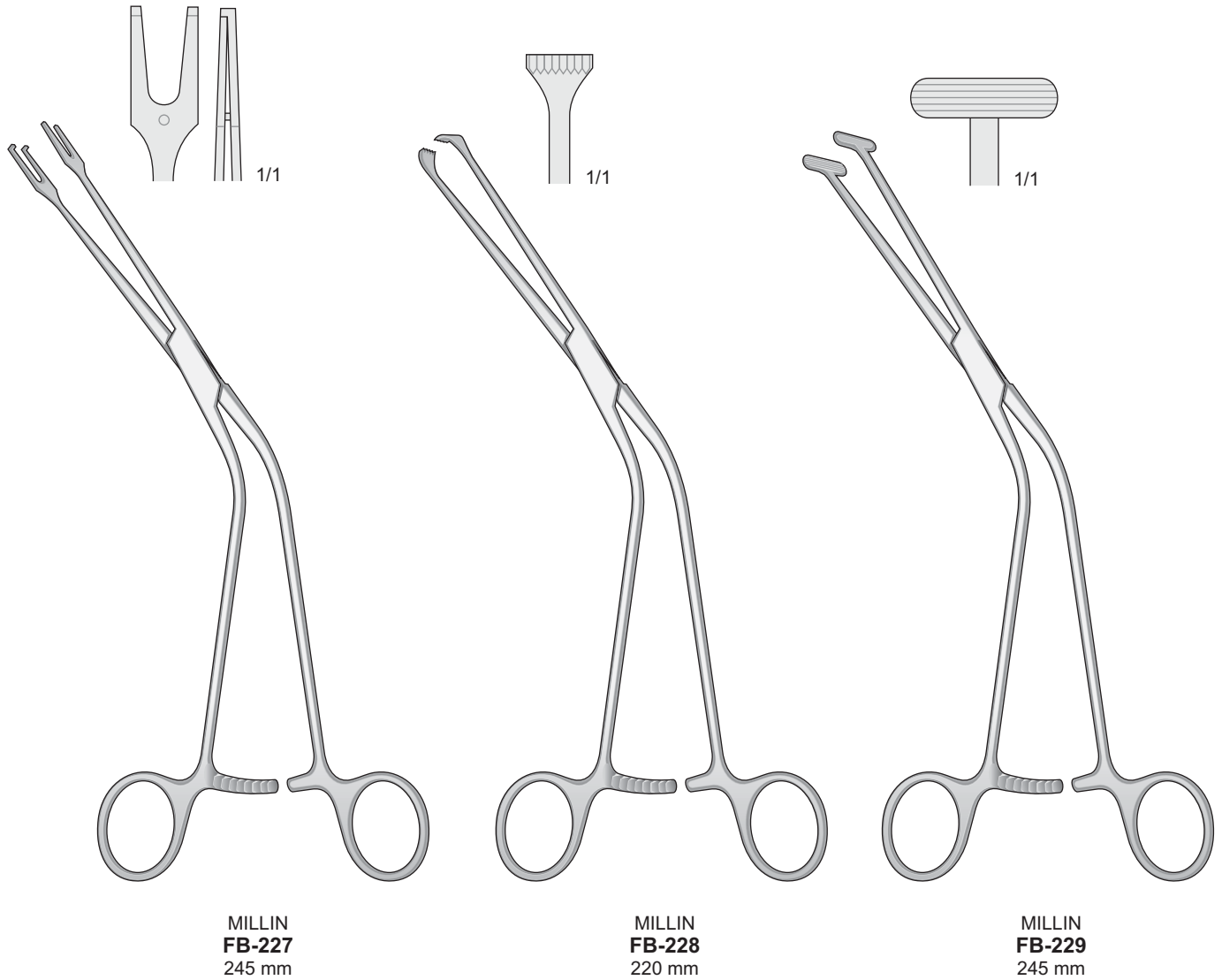

Atraumatische - Atraumatic
Atraumatische - Atraumáticas
Atraumatiques

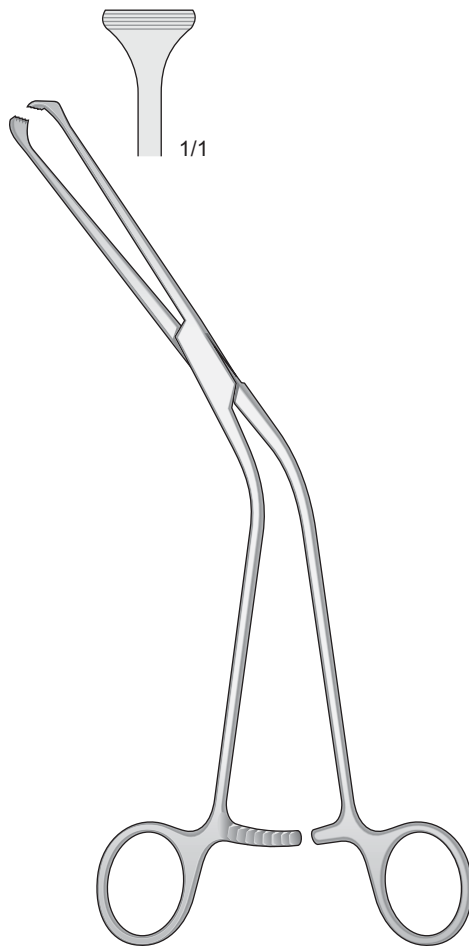

MILLIN
FB-230
220 mm

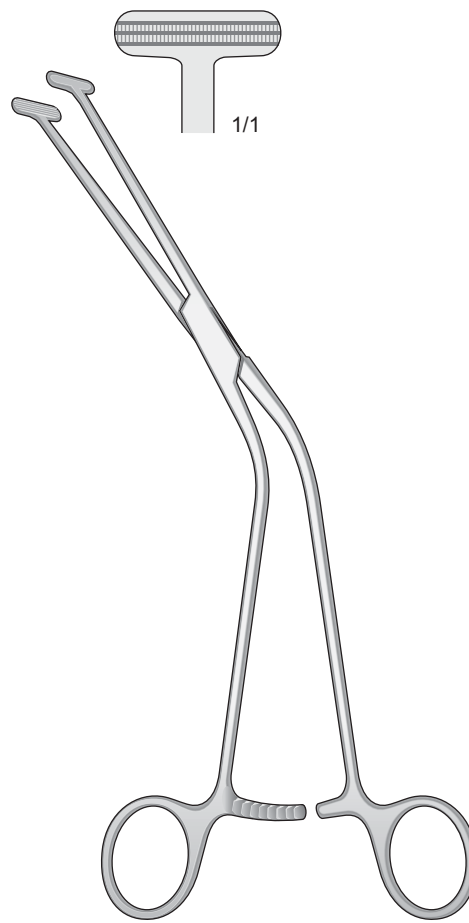

MILLIN
FB-231
245 mm

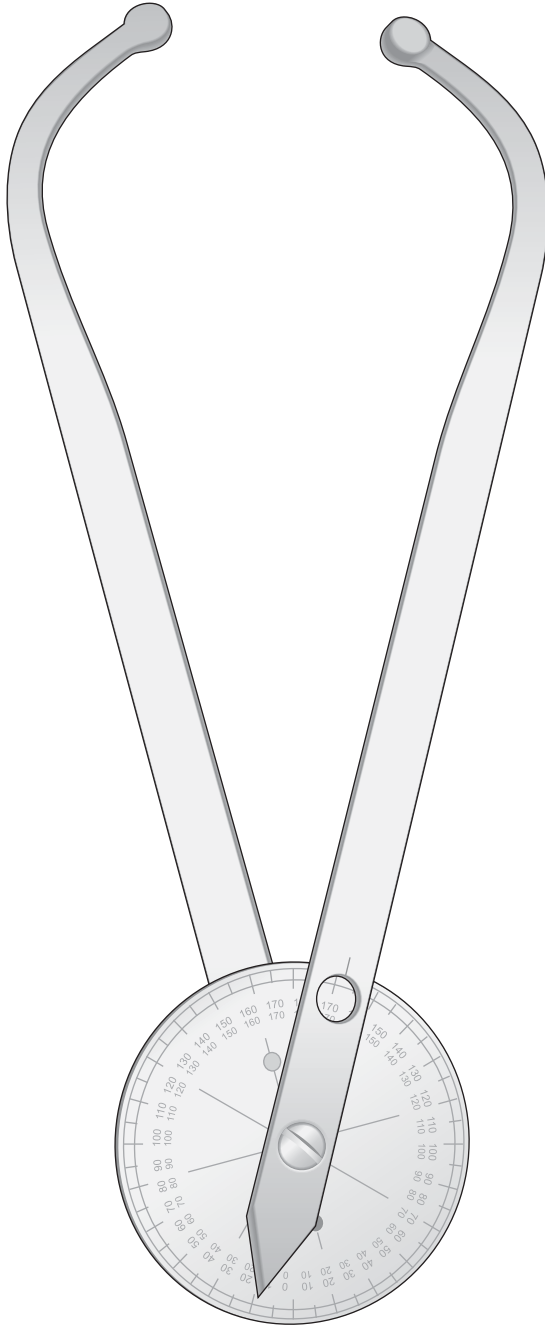

OR-32
240 mm

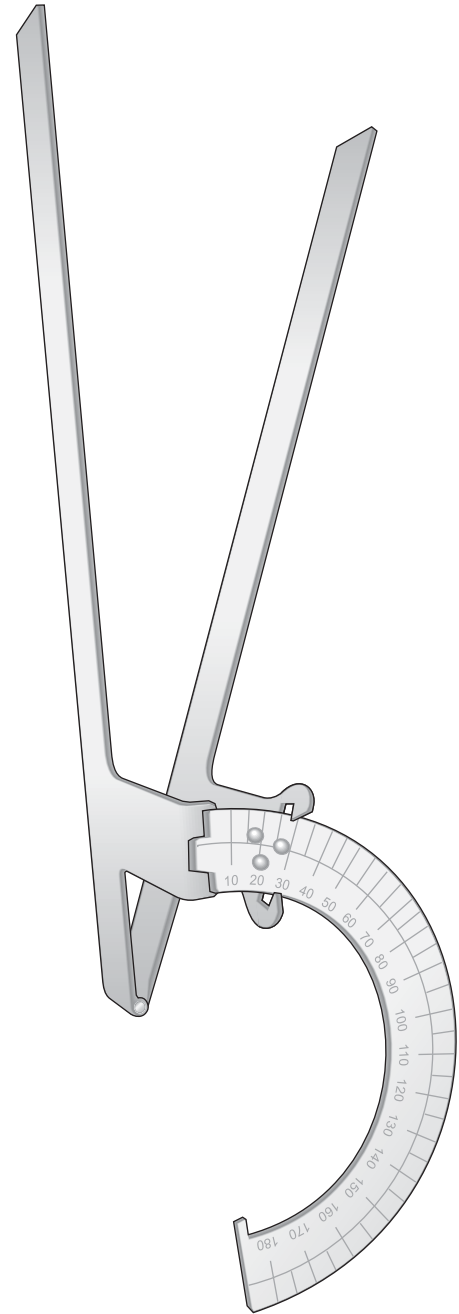

OR-33
235 mm

- BS-14** Metalletui leer für 8 Hegar Uterusdilatoren
Scatola vuota per 8 dilatatori uterini Hegar
- BS-15** Metalletui leer für 13 Hegar Uterusdilatoren
Scatola vuota per 13 dilatatori uterini Hegar
- BS-16** Metalletui leer für 14 Hegar Uterusdilatoren
Scatola vuota per 14 dilatatori uterini Hegar

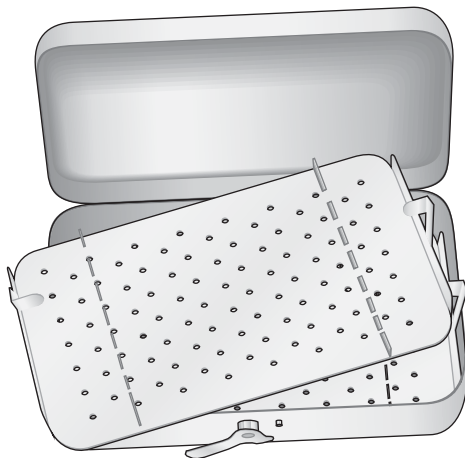

Lagerungsgestell für 15 Stück Nadeln
Rack for 15 needles
Piastra per 15 aghi oftalmici

150 x 100 x 2 mm

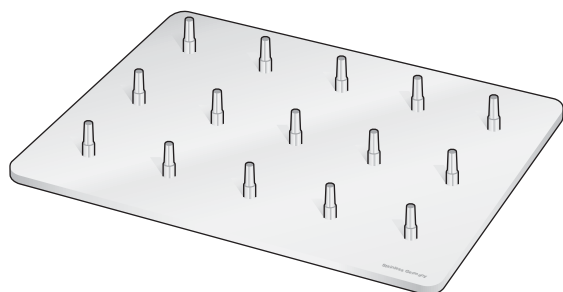

BS-20
150 x 100 x 2 mm



BS-32
180 x 85 x 20 mm

Ohrspekulaständer
Ear specula storage rack
Supporto per specoli auricolari
Soporte para espéculos auriculares
Support pour spéculums auriculaires

150 x 100 x 2 mm

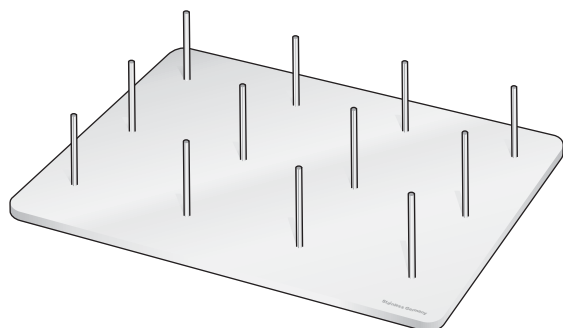

BS-21
150 x 100 x 2 mm



BS-31
180 x 85 x 30 mm

Tray Inox mit Silikoneinrichtung - Stainless Steel Cassettes with Silicone Racks
Tray Inox con griglia in silicone - Recipientes de acero con equipo de silicona
Cassettes en acier avec aménagement en silicone

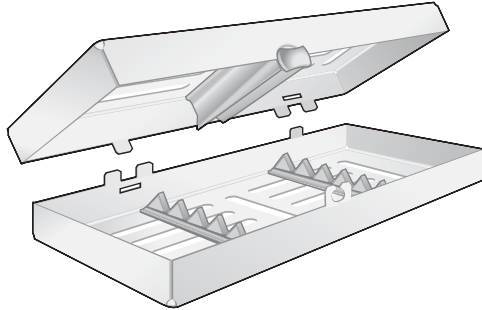

BS-59
185 x 75 x 35 mm
Für 5 Instrumente
For 5 Instruments
Per 5 strumenti
Para 5 instrumentos
Pour 5 instruments

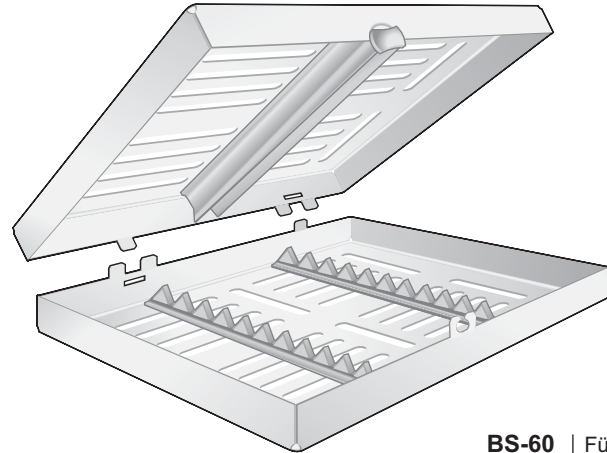

BS-60
185 x 135 x 35 mm
Für 10 Instrumente
For 10 Instruments
Per 10 strumenti
Para 10 instrumentos
Pour 10 instruments

BS-61
290 x 185 x 35 mm
Für 20 Instrumente
For 20 Instruments
Per 20 strumenti
Para 20 instrumentos
Pour 20 instruments

Set Assistent Standard
Set Pronto Soccorso

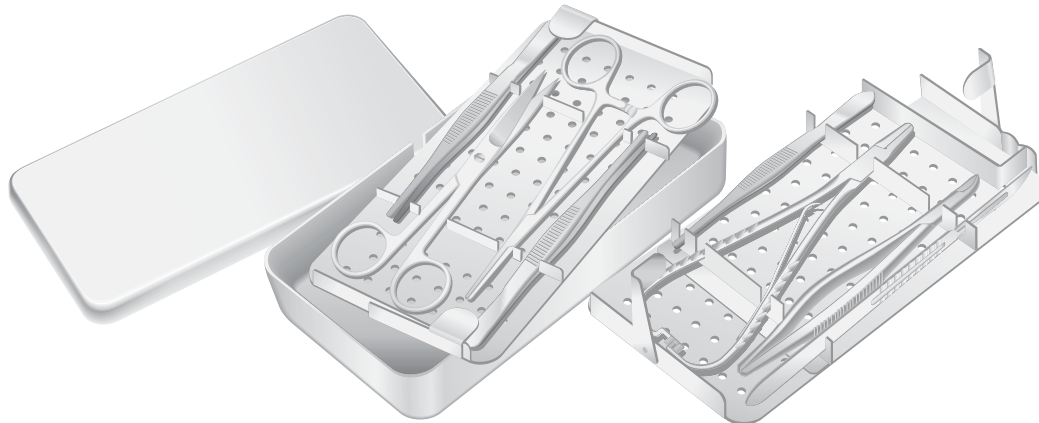

MP-200
165 x 90 x 28 mm

Plastica - Autoclavabile

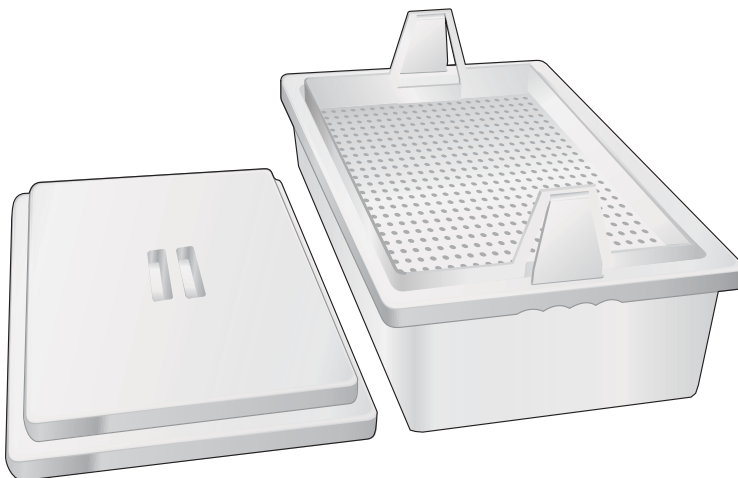

BS-105
350 x 240 x 120 mm

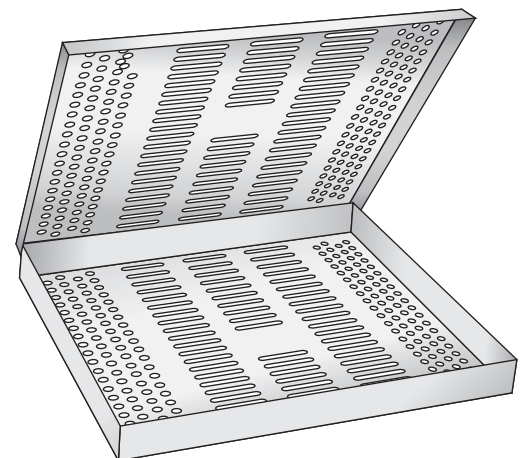

BS-43
270 x 190 x 25 mm

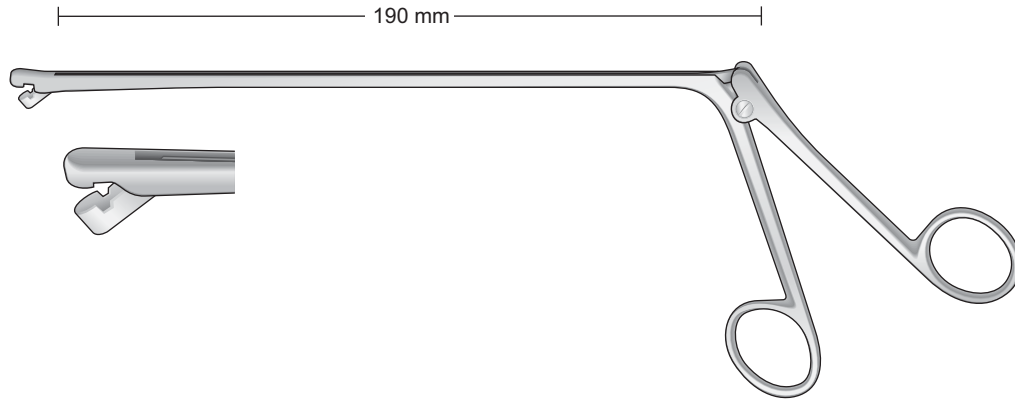

BERGER
FF-65



FF-471 7 Fr.
FF-472 9 Fr.



FF-473 7 Fr.
FF-474 9 Fr.



FF-475 7 Fr.
FF-476 9 Fr.



FF-471/FF-476

A1-Z1

Alphanumeric Index
Alphanumerischen Index
Index alphanumérique
Índice alfanumérico
Índice alfanumerico

A1-Z1



AA-100	11	AC-15	5	BD-153	124	BD-220	131	BD-30	116	BD-92	116
AA-101	11	AC-16	5	BD-154	124	BD-221	132	BD-300	716	BD-93	116
AA-102	11	AC-20	5	BD-155	124	BD-222	132	BD-303	110	BD-94	125
AA-103	11	AC-30	5	BD-156	124	BD-223	132	BD-306	110	BD-95	120
AA-104	11	AC-40	5	BD-157	125	BD-224	132	BD-30T	718	BD-96	114
AA-130	17	AN-10	805	BD-16	118	BD-225	132	BD-31	116	BD-97	117
AA-151	17	AN-11	805	BD-160	127	BD-226	131	BD-314	110	BD-98	117
AA-153	17	AN-12	805	BD-160T	718	BD-227	131	BD-315	110	BD-99	117
AA-200	12	AN-13	805	BD-161	127	BD-228	131	BD-31T	718	BF-01	142, 633
AA-201	12	AN-14	805	BD-161T	718	BD-229	132	BD-32	113	BF-02	142, 633
AA-202	12	AN-15	805	BD-162	127	BD-23	117	BD-33	113	BF-03	139, 633
AA-203	12	AN-16	805	BD-162T	718	BD-230	130	BD-34	113	BF-04	139, 633
AA-204	12	AN-17	805	BD-163	127	BD-231	130	BD-35	113	BF-05	142
AA-250	15	BB-38	34	BD-163T	718	BD-232	131	BD-351	719	BF-06	142
AA-251	15	BB-40	34	BD-164	127	BD-233	131	BD-352	719	BF-07	142
AA-252	15	BB-46	34	BD-165	128	BD-234	131	BD-353	719	BF-08	142
AA-253	15	BB-48	34	BD-166	128	BD-235	107, 618	BD-354	719	BF-10	139
AA-254	15	BB-50	34	BD-167	128	BD-236	107	BD-355	719	BF-100	631
AA-401	13	BB-52	34	BD-168	128	BD-237	107	BD-356	719	BF-102	722
AA-402	13	BD-04	114	BD-169	128	BD-238	115	BD-36	113	BF-103	722
AA-403	13	BD-05	115	BD-16T	718	BD-239	115	BD-37	125	BF-104	722
AA-404	13	BD-06	115	BD-17	124	BD-23IS	720	BD-38	121	BF-106	721
AA-500	14	BD-07	114	BD-170	128	BD-24	117	BD-39	121	BF-107	721
AA-501	14	BD-09	121	BD-171	128	BD-240	118	BD-40	113	BF-108	721
AA-502	14	BD-09T	718	BD-172	128	BD-241	118	BD-41	113	BF-109	721
AA-503	14	BD-10	117	BD-173	128	BD-242	118	BD-42	113	BF-11	141
AA-504	14	BD-100	117	BD-174	134	BD-243	118	BD-42T	718	BF-110	721
AA-70	17	BD-101	133	BD-175	125	BD-244	118	BD-43	113	BF-111	721
AA-80	17	BD-102	133	BD-176	125	BD-245	118	BD-43T	718	BF-112	733
AA-90H	17	BD-104	121	BD-177	716	BD-246	118	BD-44	115	BF-113	733
AA-B100	11, 17	BD-105	117	BD-178	716	BD-247	118	BD-45	115	BF-114	733
AA-B101	11, 17	BD-106	122	BD-179	133	BD-248	118	BD-46	115	BF-12	139
AA-E103	701	BD-107	122	BD-18	121	BD-249	118	BD-47	115	BF-13	141
AA-S103	16	BD-108	122	BD-180	121	BD-24IS	720	BD-50	134	BF-14	141
AA-S104	16	BD-109	119	BD-181	121	BD-25	117	BD-51	716	BF-15	141
AA-S105	16	BD-10IS	720	BD-182	121	BD-250	130	BD-52	271	BF-16	8, 144
AA-S203	16	BD-110	119	BD-183	121	BD-251	130	BD-53	120	BF-17	721
AA-S204	16	BD-111	119	BD-184	124	BD-252	131	BD-54	120	BF-18	632
AA-S205	16	BD-112	119	BD-185	124	BD-253	716	BD-60	112	BF-19	632
AA-S253	16	BD-113	119	BD-186	126	BD-26	117	BD-60T	718	BF-20	139
AA-S254	16	BD-114	119	BD-19	121	BD-264	719	BD-61	118	BF-22	140
AA-S255	16	BD-115	122	BD-190	126	BD-265	719	BD-62	112	BF-23	140
AA-S403	16	BD-116	122	BD-191	126	BD-266	719	BD-62T	718	BF-24	140
AA-S404	16	BD-117	122	BD-192	126	BD-267	717	BD-63	118	BF-25	140
AA-S503	16	BD-118	122	BD-193	133	BD-268	717	BD-64	112	BF-26	140
AA-S504	16	BD-119	122	BD-194	114	BD-269	717	BD-65	118	BF-27	140
AA-S505	16	BD-120	134	BD-194IS	720	BD-26IS	720	BD-66	112	BF-28	140
AA-T60	17	BD-121	134	BD-195	114	BD-27	125	BD-67	118	BF-29	140
AB-04	18	BD-122	134	BD-196	114	BD-271	119	BD-68	112	BF-30	142, 633
AB-05	18	BD-123	134	BD-197	719	BD-272	119	BD-69	719	BF-31	142, 633
AB-06	18	BD-124	117	BD-198	129	BD-273	119	BD-70	116	BF-32	632
AB-07	18	BD-126	117	BD-199	129	BD-273IS	720	BD-71	116	BF-33	632
AB-09	18	BD-127	119	BD-20	121	BD-274	119	BD-72	116	BF-34	632
AB-10	3	BD-128	121	BD-200	112	BD-275	119	BD-73	116	BF-35	632
AB-11	3	BD-129	121	BD-201	112	BD-276	119	BD-74	117	BF-36	146
AB-12	3	BD-130	129	BD-202	112	BD-277	119	BD-75	117	BF-38	146
AB-14	3	BD-131	129	BD-203	112	BD-277IS	720	BD-75T	718	BF-40	146
AB-16	3	BD-132	129	BD-204	618	BD-278	119	BD-76	117	BF-41	146
AB-18	3	BD-133	121	BD-205	112	BD-279	717	BD-78	117	BF-42	146, 620
AB-32	18	BD-134	121	BD-206	112	BD-28	124	BD-79	117	BF-43	146
AB-32R	18	BD-135	129	BD-207	716	BD-280	717	BD-80	127	BF-44	146
AB-34	18	BD-136	129	BD-208	716	BD-281	120	BD-80T	718	BF-45	146
AB-38	18	BD-138	122	BD-209	716	BD-282	120	BD-81	127	BF-46	146
AB-40	18	BD-139	122	BD-20IS	720	BD-283	717	BD-81T	718	BF-48	146
AB-41	18	BD-14	120	BD-21	120	BD-284	717	BD-82	127	BF-49	643
AB-41R	18	BD-140	129	BD-210	130	BD-286	717	BD-83	127	BF-50	147
AB-49	701	BD-141	116	BD-211	130	BD-287	120	BD-84	127	BF-51	644
AB-50	10	BD-144	119	BD-212	130	BD-288	120	BD-84T	718	BF-52	147
AB-51	10	BD-145	115	BD-213	130	BD-289	120	BD-85	127	BF-53	644
AB-52	10	BD-146	133	BD-214	130	BD-29	125	BD-86	127	BF-54	644
AB-54	10	BD-147	133	BD-215	130	BD-290	120	BD-86T	718	BF-55	643
AB-55	10	BD-148	118	BD-216	130	BD-291	120	BD-87	127	BF-56	794
AC-11	5	BD-149	122	BD-217	130	BD-292	120	BD-88	127	BF-57	794
AC-12	5	BD-15	120	BD-218	131	BD-293	717	BD-89	127	BF-58	731
AC-13	5	BD-151	125	BD-219	131	BD-294	717	BD-90	116	BF-59	643
AC-14	5	BD-152	125	BD-22	133	BD-295	717	BD-91	120	BF-60	643

BF-61	644	BM-18	267	BS-14	812	BT-153	302	BT-264	744	BT-352	750
BF-62	644	BM-19	262	BS-15	812	BT-154	302	BT-265	744	BT-353	750
BF-63	644	BM-20	262	BS-16	812	BT-155	302	BT-267	748	BT-354	750
BF-64	798	BM-21	263	BS-17	797	BT-156	302	BT-268	748	BT-355	750
BF-65	271	BM-22	263	BS-20	812	BT-157	302	BT-269	748	BT-356	750
BF-68	271	BM-23	263	BS-21	812	BT-16	283, 617	BT-27	288	BT-357	324
BF-69	271	BM-24	263	BS-23	692	BT-160	320	BT-270	744	BT-358	324
BF-71	730	BM-25	269	BS-27	692	BT-161	320	BT-271	744	BT-359	324
BF-72	147	BM-26	269	BS-28	692	BT-162	320	BT-272	744	BT-36	299
BF-73	147	BM-27	177	BS-30	692	BT-163	320	BT-274	323	BT-360	316
BF-74	147	BM-28	268	BS-31	812	BT-164	320	BT-275	293	BT-361	316
BF-75	147	BM-29	267	BS-32	812	BT-165	320	BT-276	293	BT-366	749
BF-76	730	BM-30	177	BS-40	692	BT-166	321	BT-277	293	BT-367	749
BF-77	730	BM-31	177	BS-41	692	BT-167	321	BT-278	293	BT-368	749
BF-78	141	BM-32	177	BS-42	692	BT-168	321	BT-279	293	BT-369	749
BF-79	141	BM-33	177	BS-43	813	BT-17	322	BT-28	287	BT-37	397
BF-80	726	BM-34	177	BS-59	813	BT-18	288	BT-280	309	BT-375	747
BF-81	726	BM-35	177	BS-60	813	BT-180	306	BT-281	309	BT-376	747
BF-82	148	BM-36	177	BS-61	813	BT-181	306	BT-282	291	BT-377	747
BF-85	148	BM-37	177	BT-03	322	BT-182	306	BT-283	291	BT-378	747
BF-86	148	BM-38	177	BT-04	322	BT-186	743	BT-284	291	BT-379	747
BF-87	148	BM-39	177	BT-04M	746	BT-187	743	BT-285	291	BT-38	285
BF-88	148	BM-40	269	BT-05	401	BT-188	743	BT-286	291	BT-39	285
BF-90	148	BM-41	269	BT-06	401	BT-189	743	BT-287	291	BT-40	285
BF-91	148	BM-44	265	BT-07	401	BT-19	288	BT-288	291	BT-401	743
BF-92	148	BM-45	265	BT-1	397	BT-190	285	BT-289	291	BT-402	743
BF-93	148	BM-46	266	BT-10	589	BT-191	285	BT-29	288	BT-403	743
BF-94	141	BM-47	266	BT-100	302	BT-192	285	BT-290	309	BT-404	743
BF-95	141	BM-48	265	BT-101	295	BT-193	285	BT-291	290	BT-405	743
BF-96	630	BM-49	265	BT-102	295	BT-194	285	BT-292	745	BT-406	743
BF-97	630	BM-50	505	BT-103	295	BT-195	285	BT-293	745	BT-407	743
BF-98	730	BM-51	505	BT-104	295	BT-2	397	BT-294	290	BT-408	743
BF-99	730	BM-52	266	BT-105	295	BT-20	290	BT-296	289	BT-409	743
BK-30	533	BM-53	266	BT-106	295	BT-203	283	BT-297	289	BT-41	285
BM-01	253	BM-60	269	BT-107	295	BT-204	283	BT-298	289	BT-410	743
BM-02	253	BM-61	246	BT-108	295	BT-207	283	BT-299	289	BT-411	743
BM-03	253	BM-62	246	BT-109	288	BT-208	283	BT-31	323	BT-412	743
BM-04	253	BM-63	246	BT-110	301	BT-210	284	BT-312	292	BT-415	808
BM-09	504	BM-64	246	BT-111	301	BT-211	284	BT-315	309	BT-416	808
BM-10	504	BM-65	264	BT-112	301	BT-212	284	BT-316	309	BT-417	808
BM-100	752	BM-66	264	BT-113	292	BT-213	284	BT-317	309	BT-418	808
BM-101	752	BM-68	268, 505	BT-114	292	BT-214	284	BT-318	309	BT-419	808
BM-102	270	BM-69	268, 505	BT-115	292	BT-215	284	BT-319	310	BT-42	285
BM-103	270	BM-70	267	BT-116	292	BT-216	284	BT-320	310	BT-43	299
BM-104	270	BM-71	267	BT-117	292	BT-217	284	BT-321	310	BT-44	285
BM-105	270	BM-72	267	BT-118	292	BT-218	284	BT-322	310	BT-45	285
BM-106	270	BM-73	267	BT-12	589	BT-22	288	BT-323	746	BT-46	285
BM-107	270	BM-74	268, 505	BT-120	298	BT-220	313	BT-324	746	BT-48	287
BM-11	504	BM-75	264	BT-121	298	BT-221	313	BT-327	308	BT-49	287
BM-112	270	BM-76	264	BT-122	298	BT-222	313	BT-328	308	BT-490	720
BM-113	270	BM-77	264	BT-123	298	BT-223	313	BT-329	308	BT-491	720
BM-114	270	BM-78	264	BT-124	297	BT-227	314	BT-33	299	BT-492	720
BM-115	270	BM-79	262	BT-125	297	BT-228	314	BT-330	308	BT-493	720
BM-116	270	BM-80	262	BT-126	294	BT-229	314	BT-331	319	BT-50	286
BM-117	270	BM-83	263	BT-127	294	BT-23	297	BT-332	319	BT-51	286
BM-12	504	BM-84	263	BT-128	294	BT-24	297	BT-333	319	BT-52	286
BM-122	270	BM-87	752	BT-130	303	BT-246	307	BT-334	319	BT-54	286
BM-123	270	BM-88	752	BT-131	311	BT-247	307	BT-335	319	BT-55	286
BM-124	270	BM-89	752	BT-133	311	BT-248	307	BT-336	319	BT-56	286
BM-125	270	BM-90	752	BT-134	305	BT-249	307	BT-337	745	BT-57	565
BM-126	270	BM-93	177, 617	BT-135	305	BT-25	290	BT-338	745	BT-60	300
BM-127	270	BM-95	177, 617	BT-136	304	BT-250	301	BT-339	745	BT-62	300
BM-13	504	BM-96	752	BT-137	305	BT-251	301	BT-34	299	BT-64	300
BM-132	270	BM-97	752	BT-139	294	BT-252	301	BT-340	745	BT-65	300
BM-133	270	BM-98	752	BT-14	589	BT-253	301	BT-341	317	BT-66	300
BM-134	270	BM-99	752	BT-140	294	BT-254	301	BT-342	317	BT-67	303
BM-135	270	BPS-10	693	BT-141	296	BT-255	363	BT-343	751	BT-68	303
BM-136	270	BPS-12	693	BT-142	296	BT-256	363	BT-344	318	BT-69	299
BM-137	270	BPS-14	693	BT-143	296	BT-257	363	BT-345	318	BT-70	287, 618
BM-14	504	BPS-15	693	BT-144	296	BT-258	363	BT-346	751	BT-71	287
BM-140	752	BPS-17	693	BT-145	296	BT-259	363	BT-347	315	BT-72	287
BM-141	752	BR-20	693	BT-146	296	BT-26	288	BT-348	315	BT-73	287
BM-142	752	BR-25	693	BT-147	296	BT-260	300	BT-349	315	BT-74	287
BM-15	262	BR-28	693	BT-148	296	BT-261	300	BT-35	299	BT-75	287
BM-16	262	BS-1	691	BT-15	283	BT-262	300	BT-350	315	BT-77	287
BM-17	267	BS-105	813	BT-152	302	BT-263	300	BT-351	750	BT-79	287

BT-80	306	BV-153	359	BV-247	370	BV-325	345	BV-412	761	CS-43	694
BT-81	306	BV-156	359	BV-248	370	BV-326	345	BV-42	358	CS-44	694
BT-82	306	BV-157	359	BV-249	352	BV-327	345	BV-43	358	CS-45	694
BT-83	291	BV-158	349	BV-25	332	BV-328	345	BV-45	327	CS-51	691
BT-84	576	BV-159	349	BV-250	352	BV-329	345	BV-46	360	CS-52	691
BT-85	576	BV-16	328	BV-251	352	BV-33	357	BV-47	327	CS-55	691
BT-86	576	BV-160	350	BV-252	352	BV-330	345	BV-48	327	CS-61	693
BT-87	576	BV-161	350	BV-253	352	BV-331	361	BV-49	327	CS-63	693
BT-88	576	BV-162	349	BV-254	352	BV-332	361	BV-51	327	CS-65	693
BT-89	576	BV-163	351	BV-255	352	BV-333	361	BV-52	327	CS-66	693
BT-90	304	BV-164	351	BV-256	352	BV-334	361	BV-55	331	CS-67	693
BT-91	304	BV-165	351	BV-257	352	BV-335	361	BV-56	331	CS-80	691
BT-92	302	BV-166	351	BV-258	352	BV-336	361	BV-57	367	CS-81	691
BT-93	302	BV-167	351	BV-259	352	BV-337	361	BV-58	366	CS-82	691
BT-94	302	BV-168	351	BV-26	330	BV-338	361	BV-59	366	CS-83	691
BT-95	302	BV-169	351	BV-260	352	BV-339	361	BV-60	365	DB-100	554
BT-96	302	BV-17	328	BV-262	364	BV-340	362	BV-62	365	DB-100	788
BT-97	312	BV-170	351	BV-263	364	BV-341	362	BV-64	365	DB-101	459
BT-98	312	BV-171	351	BV-264	364	BV-342	362	BV-66	365	DB-102	459
BT-99	312	BV-172	351	BV-265	364	BV-343	362	BV-67	762	DB-103	459
BV-02	599	BV-173	351	BV-269	352	BV-344	362	BV-68	341	DB-104	459
BV-04	599	BV-174	351	BV-27	338	BV-345	362	BV-69	341	DB-105	459
BV-05	599	BV-175	351	BV-270	352	BV-346	361	BV-70	341	DB-106	554
BV-06	599	BV-176	351	BV-271	352	BV-347	361	BV-71	341	DB-106	786
BV-07	330	BV-177	351	BV-272	352	BV-348	361	BV-72	341	DB-107	554
BV-08	327	BV-178	351	BV-273	352	BV-349	362	BV-73	341	DB-107	786
BV-09	330	BV-179	351	BV-274	352	BV-35	350	BV-74	341	DB-108	554
BV-10	327	BV-18	331	BV-275	352	BV-350	362	BV-75	341	DB-109	554
BV-100	758	BV-180	351	BV-276	352	BV-354	369	BV-76	335	DB-111	552
BV-101	337	BV-181	351	BV-277	352	BV-355	369	BV-77	335	DB-113	552
BV-102	337	BV-182	351	BV-279	352	BV-357	369	BV-78	335	DB-114	552
BV-103	758	BV-183	349	BV-28	338	BV-358	369	BV-79	335	DB-120	553
BV-104	759	BV-184	359	BV-280	352	BV-359	369	BV-80	356	DB-121	553
BV-105	759	BV-185	359	BV-281T	353	BV-36	327	BV-82	356	DB-122	553
BV-108	329	BV-186	359	BV-282T	353	BV-360	369	BV-84	356	DB-123	553
BV-109	329	BV-187	359	BV-283T	353	BV-366	348	BV-85	356	DB-124	553
BV-11	329	BV-188	359	BV-284T	353	BV-367	348	BV-86	356	DB-125	553
BV-110	335	BV-189	359	BV-285T	353	BV-368	348	BV-88	336	DB-129	553
BV-111	330	BV-19	332	BV-286T	353	BV-369	348	BV-89	336	DB-136	784
BV-112	330	BV-190	339	BV-287T	353	BV-37	327	BV-90	333	DB-137	784
BV-113	759	BV-191	339	BV-288T	353	BV-370	348	BV-91	333	DB-138	784
BV-114	759	BV-192	339	BV-289T	353	BV-371	348	BV-92	333	DB-139	784
BV-115	759	BV-193	339	BV-290T	353	BV-372	346, 347	BV-93	333	DB-141	459
BV-116	759	BV-194	349	BV-291T	353	BV-373	347	BV-94	334	DB-143	459
BV-117	335	BV-195	349	BV-292T	353	BV-374	347	BV-95	334	DB-145	459
BV-118	335	BV-196	349	BV-293T	353	BV-375	347	BV-96	334	DB-147	784
BV-119	338	BV-197	349	BV-294T	353	BV-376	347	BV-97	334	DB-148	784
BV-12	327	BV-198	349	BV-295T	353	BV-377	347	BV-98	336	DB-149	784
BV-120	338	BV-199	349	BV-296T	353	BV-378	347	BV-99	336	DB-150	648
BV-121	342	BV-20	331	BV-297T	353	BV-379	347	C-1	415	DB-180	453
BV-122	342	BV-200	349	BV-298T	353	BV-38	327	C-2	415	DB-181	453
BV-123	343	BV-201	354	BV-299T	353	BV-380	347	C-3	415	DB-182	453
BV-124	343	BV-202	354	BV-30	357	BV-381	347	C-4	415	DB-1L	687
BV-125	367	BV-203	354	BV-300T	353	BV-382	347	CS-01	691	DB-20	551
BV-126	367	BV-204	354	BV-301T	353	BV-383	363	CS-02	691	DB-201	787
BV-128	367	BV-205	354	BV-302T	353	BV-384	363	CS-03	691	DB-202	787
BV-13	329	BV-206	354	BV-303T	353	BV-385	363	CS-04	691	DB-203	787
BV-130	340	BV-207	354	BV-304T	353	BV-386	363	CS-05	691	DB-204	787
BV-131	340	BV-208	354	BV-305T	353	BV-387	363	CS-06	691	DB-205	787
BV-135	344	BV-209	355	BV-306T	353	BV-388	363	CS-07	693	DB-206	787
BV-136	344	BV-21	332	BV-307T	353	BV-389	363	CS-08	693	DB-207	787
BV-137	344	BV-210	355	BV-308T	353	BV-39	327	CS-09	693	DB-208	787
BV-138	344	BV-211	355	BV-309T	353	BV-390	363	CS-12	694	DB-209	787
BV-139	344	BV-212	355	BV-31	357	BV-40	358	CS-15	694	DB-21	551, 617
BV-14	328	BV-213	355	BV-310T	353	BV-401	760	CS-19	694	DB-213	788
BV-141	346	BV-214	355	BV-315	758	BV-402	760	CS-20	694	DB-214	788
BV-142	346	BV-215	355	BV-316	758	BV-403	760	CS-21	694	DB-215	788
BV-143	346	BV-216	355	BV-317	345	BV-404	760	CS-22	694	DB-216	788
BV-144	349	BV-22	331	BV-318	345	BV-405	760	CS-25	694	DB-217	788
BV-145	346	BV-229	353	BV-319	345	BV-406	760	CS-30	694	DB-218	788
BV-146	346	BV-23	332	BV-32	357	BV-407	761	CS-32	694	DB-219	788
BV-148	346	BV-24	332	BV-320	345	BV-408	761	CS-33	694	DB-220	789
BV-15	328	BV-241	370	BV-321	345	BV-409	761	CS-34	694	DB-221	789
BV-150	360	BV-242	370	BV-322	345	BV-41	358	CS-40	694	DB-222	789
BV-151	360	BV-245	370	BV-323	345	BV-410	761	CS-41	694	DB-223	789
BV-152	360	BV-246	370	BV-324	345	BV-411	761	CS-42	694	DB-224	789

DB-225	789	DO-130	438	DO-220	386	DO-75	409	EA-21	174	EB-143	636
DB-226	789	DO-131	438	DO-221	386	DO-76	409	EA-26	735	EB-144	636
DB-22-A	688	DO-132	438	DO-222	386	DO-77	573	EA-27	735	EB-15	645
DB-23	551	DO-133	438	DO-223	386	DO-78	573	EA-30	171	EB-150	637
DB-24	551	DO-138	400	DO-224	386	DO-79	410	EA-31	171	EB-151	637
DB-25	551	DO-139	400	DO-23	567	DO-80	410	EA-32	171	EB-152	637
DB-27	753	DO-14	550	DO-236	756	DO-81	410	EA-33	171	EB-156	637
DB-28	753	DO-140	438	DO-237	756	DO-82	410	EA-36	171	EB-157	637
DB-299	688	DO-141	438	DO-24	567	DO-83	410	EA-37	171	EB-158	637
DB-30	551	DO-142	545	DO-240	396	DO-84	577	EA-38	735	EB-16	645
DB-31	551	DO-143	438	DO-241	396	DO-85	577	EA-39	735	EB-160	637
DB-32	551	DO-144	565	DO-242	381	DO-86	388	EA-40	369	EB-162	637
DB-36	551	DO-145	565	DO-243	381	DO-87	573	EA-50	173	EB-163	637
DB-37	551	DO-146	565	DO-244	396	DO-88	575	EA-51	173	EB-164	637
DB-38	551	DO-147	563	DO-247	548	DO-89	575	EA-52	173	EB-166	637
DB-39	551	DO-148	563	DO-248	548	DO-90	399	EA-53	173	EB-17	794
DB-4	688	DO-149	563	DO-25	567	DO-91	565	EA-54	173	EB-170	638
DB-40	753	DO-15	550	DO-250	582	DO-92	565	EA-55	173	EB-171	638
DB-41	753	DO-150	579	DO-251	582	DO-94	546	EA-60	624	EB-172	638
DB-47	753	DO-151	579	DO-252	582	DO-95	546	EA-62	624	EB-173	638
DB-5L	687	DO-152	579	DO-257	581	DO-96	546	EA-63	624	EB-174	638
DB-6-A	688	DO-153	579	DO-258	581	DO-97	546	EA-64	624	EB-175	638
DB-86	786	DO-154	579	DO-26	567	DO-98	387	EA-65	624	EB-176	638
DB-87	786	DO-155	579	DO-260	582	DO-99	387	EA-66	624	EB-177	638
DB-88	786	DO-156	579	DO-261	582	DP-08	506	EA-67	624	EB-178	638
DB-89	786	DO-157	563	DO-262	582	DP-09	488	EA-70	624	EB-179	638
DB-90	786	DO-158	579	DO-264	564	DP-101	103	EA-72	624	EB-18	628
DB-91	786	DO-16	562	DO-27	567	DP-102	103	EA-74	624	EB-184	638
DB-92	786	DO-161	580	DO-274	575	DP-103	103	EA-76	624	EB-189	638
DB-93	786	DO-162	580	DO-279	757	DP-104	103	EA-77	624	EB-19	628
DB-94	786	DO-163	580	DO-280	757	DP-105	103	EA-78	624	EB-190	637
DB-95	786	DO-164	580	DO-281	757	DP-120	102, 512	EA-79	624	EB-191	637
DB-96	688	DO-165	580	DO-282	757	DP-18	506	EA-90	624	EB-20	628
DB-97	552	DO-166	580	DO-285	575	DP-71	506	EA-91	624	EB-201	626
DB-98	552	DO-167	580	DO-286	575	DP-725	22	EA-92	624	EB-202	626
DB-99	552	DO-168	412, 572	DO-287	575	DP-75	506	EA-93	624	EB-203	626
DB-OL	688	DO-169	412, 572	DO-29	549	DP-90	102, 512	EA-94	793	EB-204	626
DB-OLR	687	DO-17	562	DO-290	575	DP-91	103	EB-100	635	EB-205	626
DE-10	806	DO-170	577	DO-3	408, 570	DP-92	103	EB-101	635	EB-206	626
DE-11	806	DO-171	577	DO-30	489	DP-96	508	EB-102	635	EB-207	626
DE-12	806	DO-172	577	DO-31	489	DR-40	732	EB-103	635	EB-208	626
DE-13	806	DO-174	289	DO-32	489	DR-50	134	EB-104	635	EB-209	626
DE-14	806	DO-175	311	DO-34	566	DR-60	134	EB-105	635	EB-21	651
DE-15	807	DO-178	409	DO-35	566	DS-01	543	EB-106	635	EB-210	626
DE-16	807	DO-179	574	DO-36	566	DS-02	543	EB-107	635	EB-211	626
DE-17	807	DO-18	437	DO-40	545	DS-10	754	EB-11	623	EB-212	626
DE-18	807	DO-180	578	DO-41	545	DS-11	754	EB-110	793	EB-213	626
DEAN	70	DO-181	578	DO-42	545	DS-12	754	EB-111	793	EB-214	626
DEAN-TC	708	DO-182	578	DO-43	545	DS-13	754	EB-117	794	EB-215	626
DO-08	544	DO-183	770	DO-44	549	DS-15	754	EB-118	794	EB-216	626
DO-09	544	DO-184	770	DO-45	388, 587	DS-16	755	EB-119	794	EB-217	626
DO-1	408, 570	DO-185	578	DO-46	388, 547	DS-17	754	EB-12	623	EB-218	626
DO-10	550	DO-186	578	DO-47	396	DS-18	754	EB-120	636	EB-219	626
DO-101	400	DO-187	578	DO-48	565	DS-19	755	EB-121	636	EB-22	651
DO-102	400	DO-188	578	DO-49	489	DS-20	755	EB-122	636	EB-220	626
DO-103	400	DO-19	549	DO-50	569	DS-26	753	EB-123	636	EB-221	626
DO-104	387	DO-190	440	DO-51	569	DS-27	753	EB-124	636	EB-222	626
DO-105	387	DO-191	440	DO-52	569	DS-28	753	EB-125	636	EB-223	626
DO-106	400	DO-192	440	DO-53	569	DS-29	753	EB-126	636	EB-23	651
DO-107	400	DO-193	440	DO-54	569	DS-30	755	EB-127	636	EB-231	628
DO-108	388	DO-194	440	DO-55	569	DS-31	755	EB-128	636	EB-232	628
DO-109	573	DO-195	440	DO-56	289	DS-32	755	EB-13	623	EB-233	628
DO-11	550	DO-196	440	DO-57	289	DS-33	755	EB-130	636	EB-234	628
DO-110	568	DO-197	440	DO-58	289	DS-34	755	EB-131	636	EB-235	628
DO-111	396	DO-198	546	DO-59	398	DS-35	755	EB-132	636	EB-236	628
DO-112	568	DO-199	546	DO-60	396	DS-36	755	EB-133	636	EB-237	628
DO-117	399	DO-2	408, 570	DO-63	398	DS-37	755	EB-134	636	EB-238	628
DO-118	577	DO-20	567	DO-65	398	DS-38	755	EB-135	636	EB-239	628
DO-119	577	DO-203	581	DO-67	398	DS-39	755	EB-136	636	EB-240	628
DO-12	550	DO-205	581	DO-68	399	EA-10	172	EB-137	636	EB-241	628
DO-120	568	DO-206	581	DO-69	399	EA-11	172	EB-138	636	EB-242	628
DO-121	568	DO-21	567	DO-70	409	EA-12	172	EB-139	636	EB-243	628
DO-122	568	DO-213	289	DO-71	409	EA-13	172	EB-14	623	EB-244	628
DO-125	547	DO-214	289	DO-72	573	EA-14	172	EB-140	636	EB-245	628
DO-126	547	DO-215	289	DO-73	574	EA-15	172	EB-141	636	EB-246	628
DO-13	550	DO-22	567	DO-74	574	EA-20	174	EB-142	636	EB-247	628

EB-248	628	EB-79	641	ER-166	641	FB-11	212	FB-188	215	FB-269	219
EB-249	628	EB-80	641	ER-17	653	FB-110	207	FB-189	216	FB-27	197
EB-25	644	EB-81	641	ER-18	653	FB-111	207	FB-19	188	FB-270	219
EB-251	626	EB-82	641	ER-21	653	FB-112	207	FB-190	213	FB-271	220
EB-252	626	EB-83	641	ER-22	653	FB-113	222	FB-191	189	FB-272	220
EB-253	626	EB-84	641	ER-23	653	FB-114	222	FB-192	216	FB-273	218
EB-254	626	EB-85	641	ER-24	653	FB-115	742	FB-193	216	FB-274	218
EB-255	626	EB-86	641	ER-25	653	FB-116	742	FB-194	216	FB-28	197
EB-256	626	EB-87	641	ER-26	653	FB-12	212	FB-195	214	FB-280	212
EB-257	626	EB-88	641	ER-27	653	FB-120	732	FB-196	214	FB-281	212
EB-258	626	EB-89	641	ER-28	653	FB-125	208	FB-197	214	FB-283	212
EB-259	626	EB-90	641	ER-31	654	FB-126	208	FB-198	214	FB-29	191
EB-260	626	EB-91	641	ER-32	654	FB-127	208	FB-199	214	FB-296	368
EB-261	626	EB-92	641	ER-41	654	FB-128	208	FB-20	188	FB-297	368
EB-262	626	EB-93	641	ER-42	654	FB-129	208	FB-201	184	FB-298	368
EB-263	626	EB-94	797	ER-46	634	FB-13	212	FB-202	184	FB-30	191
EB-264	626	EB-95	797	ER-47	634	FB-130	208	FB-203	184	FB-300	226
EB-265	626	EB-96	797	ER-48	634	FB-131	206	FB-204	184	FB-301	226
EB-266	626	EB-97	797	ER-49	634	FB-132	206	FB-205	184	FB-302	226
EB-267	626	EB-98	722	ER-50	656	FB-133	188	FB-206	213	FB-303	226
EB-270	736	EB-99	722	ER-51	656	FB-137	734	FB-207	213	FB-304	226
EB-271	736	ER-100	642	ER-52	656	FB-138	202	FB-209	213	FB-305	226
EB-272	736	ER-101	642	ER-53	656	FB-139	202	FB-21	189	FB-306	226
EB-273	736	ER-102	642	ER-58	796	FB-14	187	FB-210	213	FB-307	226
EB-274	736	ER-103	642	ER-59	796	FB-140	196	FB-211	183	FB-308	226
EB-275	736	ER-104	642	ER-60	796	FB-141	196	FB-212	183	FB-309	226
EB-290	795	ER-105	642	ER-61	634	FB-142	196	FB-213	183	FB-31	191
EB-291	795	ER-106	642	ER-62	634	FB-143	203	FB-214	183	FB-310	226
EB-292	795	ER-107	642	ER-63	634	FB-144	203	FB-215	183	FB-311	226
EB-293	795	ER-108	642	ER-72	634	FB-145	204	FB-216	185	FB-312	226
EB-294	795	ER-11	653	ER-73	634	FB-146	204	FB-217	185	FB-32	191
EB-295	795	ER-110	640	ER-74	634	FB-147	199	FB-218	727	FB-320	625
EB-30	629	ER-111	640	ER-76	798	FB-148	199	FB-219	727	FB-321	625
EB-31	175, 629	ER-112	640	ER-77	646	FB-149	199	FB-22	187	FB-322	625
EB-32	175, 629	ER-113	640	ER-78	646	FB-15	187	FB-220	727	FB-323	625
EB-33	732	ER-114	640	ER-79	646	FB-150	199	FB-221	727	FB-324	625
EB-36	623	ER-115	640	ER-80	651	FB-151	199	FB-222	727	FB-325	625
EB-37	623	ER-116	640	ER-81	651	FB-152	200	FB-223	734	FB-326	625
EB-38	623	ER-117	640	ER-82	651	FB-153	200	FB-224	734	FB-327	625
EB-39	623	ER-118	640	ER-83	651	FB-154	200	FB-225	734	FB-328	625
EB-42	627	ER-12	653	ER-84	651	FB-155	200	FB-226	734	FB-329	625
EB-43	627	ER-120	639	ER-87	794	FB-156	209	FB-227	809	FB-33	191
EB-44	627	ER-121	639	ER-88	652	FB-157	209	FB-228	809	FB-330	625
EB-45	627	ER-122	639	ER-89	794	FB-158	209	FB-229	809	FB-331	625
EB-46	627	ER-123	639	ER-90	652	FB-159	210	FB-23	187	FB-332	625
EB-47	627	ER-124	639	ER-91	634	FB-16	214	FB-230	810	FB-333	625
EB-48	627	ER-125	639	ER-92	634	FB-160	210	FB-231	810	FB-334	625
EB-49	627	ER-126	639	ER-93	634	FB-161	195	FB-236	182	FB-335	625
EB-51	641	ER-127	639	ER-96	634	FB-162	195	FB-237	182	FB-336	625
EB-52	641	ER-128	639	ER-97	634	FB-163	195	FB-238	182	FB-337	625
EB-53	641	ER-129	639	ES-151	753	FB-164	195	FB-239	182	FB-338	625
EB-54	641	ER-13	653	ES-152	753	FB-165	193	FB-24	187	FB-339	625
EB-55	641	ER-130	639	ES-153	753	FB-166	193	FB-241	181	FB-34	191
EB-56	641	ER-131	639	ES-22	753	FB-167	193	FB-242	181	FB-340	625
EB-57	641	ER-132	639	ES-44	135	FB-168	201	FB-243	181	FB-341	625
EB-58	641	ER-133	797	ES-45	135	FB-169	201	FB-244	181	FB-342	625
EB-59	641	ER-134	797	ES-46	135	FB-17	192	FB-245	181	FB-343	625
EB-60	641	ER-135	797	ES-47	135	FB-170	201	FB-246	181	FB-35	190
EB-61	641	ER-14	653	ES-48	135	FB-171	201	FB-247	181	FB-350	227
EB-62	641	ER-140	655	ES-64	135	FB-172	201	FB-248	181	FB-351	227
EB-63	641	ER-141	655	ES-65	135	FB-173	201	FB-249	181	FB-352	227
EB-64	641	ER-142	655	FB-01	187	FB-174	201	FB-25	197	FB-353	227
EB-65	641	ER-143	655	FB-02	187	FB-175	201	FB-251	182	FB-354	227
EB-66	641	ER-144	655	FB-03	189	FB-176	221	FB-252	182	FB-355	227
EB-67	641	ER-145	655	FB-04	189	FB-177	221	FB-253	182	FB-356	227
EB-68	641	ER-146	655	FB-05	189	FB-178	221	FB-254	182	FB-357	227
EB-69	641	ER-15	653	FB-06	215	FB-179	211	FB-255	182	FB-358	227
EB-70	641	ER-150	645	FB-07	215	FB-18	190	FB-256	182	FB-359	227
EB-71	641	ER-151	645	FB-08	192	FB-180	197	FB-257	182	FB-36	190
EB-72	641	ER-152	645	FB-09	192	FB-181	197	FB-258	730	FB-360	227
EB-73	641	ER-16	653	FB-10	192	FB-182	197	FB-259	730	FB-361	227
EB-74	641	ER-161	641	FB-101	229	FB-183	197	FB-26	197	FB-362	227
EB-75	641	ER-162	641	FB-103	229	FB-184	207	FB-265	198	FB-363	227
EB-76	641	ER-163	641	FB-107	228	FB-185	207	FB-266	198	FB-364	227
EB-77	641	ER-164	641	FB-108	228	FB-186	207	FB-267	198	FB-365	227
EB-78	641	ER-165	641	FB-109	228	FB-187	216	FB-268	219	FB-366	227

FB-367	227	FB-93	185	FD-171	739	FD-42	602, 617	FF-132	463	FF-460	791
FB-368	227	FB-94	205	FD-18	238	FD-420	236	FF-133	463	FF-461	791
FB-369	227	FB-95	205	FD-182	739	FD-421	236	FF-134	463	FF-462	791
FB-37	190	FB-96	217	FD-183	739	FD-423	236	FF-135	463	FF-463	791
FB-38	194	FB-97	217	FD-186	40	FD-43	605	FF-136	463	FF-464	791
FB-380	228	FB-98	217	FD-187	40	FD-44	605	FF-137	463	FF-465	791
FB-381	228	FB-99	217	FD-19	238	FD-45	39	FF-138	463	FF-466	791
FB-382	228	FD-01	605	FD-191	40	FD-46	39	FF-139	463	FF-467	791
FB-383	228	FD-02	605	FD-20	238	FD-49	602	FF-14	556	FF-468	791
FB-384	228	FD-03	602	FD-201	109	FD-50	602	FF-140	463	FF-471	814
FB-385	228	FD-04	602	FD-202	109	FD-51	605	FF-141	463	FF-472	814
FB-386	228	FD-05	602, 617	FD-203	109, 233	FD-52	605	FF-142	463	FF-473	814
FB-387	228	FD-06	39	FD-204	109, 233	FD-54	617	FF-143	463	FF-474	814
FB-388	228	FD-07	605	FD-21	239	FD-55	602	FF-144	463	FF-475	814
FB-389	228	FD-08	39	FD-211	233	FD-56	602	FF-145	463	FF-476	814
FB-39	194	FD-09	605	FD-213	233	FD-57	605	FF-146	463	FF-59	650
FB-390	779	FD-10	39, 601	FD-214	610	FD-58	605	FF-147	433	FF-60	650
FB-392	779	FD-105	234, 609, 620	FD-215	610	FD-59	606	FF-148	433	FF-61	650
FB-394	779	FD-106	234, 609	FD-216	610	FD-60	606	FF-149	433	FF-62	650
FB-395	779	FD-107	234, 609	FD-218	241	FD-61	604	FF-15	556	FF-64	649
FB-396	779	FD-108	234, 609	FD-219	241	FD-62	604	FF-16	556	FF-65	814
FB-397	779	FD-109	609	FD-22	239	FD-63	235	FF-17	556	FF-70	460
FB-398	779	FD-11	604	FD-221	41	FD-64	601	FF-180	558	FF-71	460
FB-40	194	FD-110	609	FD-223	41	FD-65	601	FF-181	558	FF-72	460
FB-400	779	FD-111	609	FD-23	239	FD-66	603	FF-182	558	FF-73	460
FB-41	176, 630	FD-112	609	FD-231	600	FD-67	603	FF-183	558	FF-74	460
FB-42	176	FD-113	234	FD-232	600	FD-68	603	FF-184	558	FF-80	461
FB-43	176, 631	FD-114	234	FD-233	600	FD-69	603, 619	FF-185	558	FF-80	792
FB-44	194	FD-115	234	FD-234	600	FD-70	603, 619	FF-186	558	FF-81	461
FB-45	186	FD-116	234	FD-235	604	FD-71	603	FF-187	558	FF-82	461
FB-46	225	FD-118	595, 618, 619	FD-236	739	FD-72	603	FF-190	763	FF-83	461
FB-47	186	FD-119	595	FD-237	739	FD-73	603	FF-191	763	FF-84	461
FB-48	186	FD-12	39, 601	FD-24	234	FD-74	603	FF-192	763	FF-85	461
FB-49	186	FD-120	595	FD-240	607	FD-79	39, 600, 619	FF-20	465	FF-86	461
FB-50	211	FD-121	611	FD-241	607	FD-80	39, 600, 619	FF-200	763, 764	FF-87	792
FB-51	211	FD-122	611	FD-242	608	FD-81	39, 600, 619	FF-201	763, 764	FF-88	792
FB-52	224	FD-123	595, 618, 619	FD-243	608	FD-82	607	FF-201M	764	FF-90	464
FB-53	224	FD-124	597, 617	FD-244	608, 620	FD-83	607	FF-202	763, 764	FF-91	464
FB-54	224	FD-125	597	FD-245	608	FD-84	607, 617	FF-203	763, 764, 765	FF-92	464
FB-55	186	FD-126	597	FD-246	235	FD-85	607, 617	FF-204	765	FG-1	44, 619
FB-57	186	FD-127	597	FD-247	235	FD-86	607	FF-205	763, 764, 765	FG-10	68
FB-58	186	FD-128	240	FD-248	235	FD-87	607	FF-206	763, 764, 765	FG-100	59
FB-59	186	FD-129	620	FD-249	235	FD-88	607	FF-21	465	FG-101	45
FB-60	180	FD-13	39, 601	FD-25	239	FD-89	607	FF-214	559	FG-102	45
FB-61	180	FD-130	597	FD-27	240	FD-90	608	FF-215	559	FG-103	45
FB-62	180	FD-132	597, 618, 619	FD-28	239	FD-91	608	FF-216	559	FG-104	44
FB-63	180	FD-134	597	FD-29	239	FD-92	608	FF-22	465	FG-105	45
FB-64	180	FD-135	617	FD-30	241	FD-93	608	FF-23	465	FG-106	69
FB-65	180	FD-136	597, 619	FD-306	42	FD-94	608	FF-30	647	FG-107	69
FB-66	180	FD-137	41, 606	FD-307	42	FD-95	608	FF-31	648	FG-108	46
FB-67	178	FD-138	41, 606	FD-31	242	FF-10	557	FF-32	647	FG-109	46
FB-68	178	FD-14	238	FD-310	42	FF-102	462	FF-33	647	FG-110	72, 476
FB-69	178	FD-146	604	FD-311	42	FF-103	462	FF-34	647	FG-111	476
FB-70	178	FD-147	604	FD-318	237	FF-104	462	FF-35	649	FG-112	704
FB-71	178	FD-148	241	FD-319	237	FF-105	462	FF-36	649	FG-113	704
FB-72	178	FD-149	241	FD-32	241	FF-106	462	FF-37	649	FG-114	704
FB-73	178	FD-15	601	FD-320	237	FF-107	462	FF-38	648	FG-115	704
FB-74	178	FD-150	609	FD-321	237	FF-108	462	FF-39	648	FG-116	58
FB-75	178	FD-151	609	FD-326	237	FF-109	462	FF-401	555	FG-117	57
FB-76	179	FD-152	610	FD-327	237	FF-11	557	FF-402	555	FG-118	704
FB-77	179	FD-153	610	FD-328	237	FF-110	462	FF-403	555	FG-119	46
FB-78	179	FD-154	610	FD-329	237	FF-111	462	FF-404	555	FG-11L	83
FB-79	179	FD-155	610	FD-33	240	FF-12	557	FF-411	555	FG-122	705
FB-80	179	FD-156	610	FD-34	242	FF-120	463	FF-412	555	FG-123	47
FB-81	179	FD-157	610	FD-35	240	FF-121	463	FF-413	555	FG-124	47
FB-82	179	FD-158	617	FD-36	242	FF-122	463	FF-414	555	FG-125	68
FB-83	179	FD-159	617	FD-37	242	FF-123	463	FF-450	790	FG-126	68
FB-84	177	FD-16	238	FD-38	242	FF-124	463	FF-451	790	FG-127	68
FB-85	177	FD-160	608	FD-39	240	FF-125	463	FF-452	790	FG-128	68
FB-86	177	FD-161	608	FD-40	606	FF-126	463	FF-453	790	FG-129	78
FB-87	177	FD-162	609	FD-408	43	FF-127	463	FF-454	790	FG-12L	83
FB-88	225	FD-165	611	FD-409	43	FF-128	463	FF-455	790	FG-13	44
FB-89	225	FD-166	611	FD-41	602	FF-129	463	FF-456	790	FG-130	711
FB-90	185	FD-169	611	FD-410	43	FF-13	557	FF-457	790	FG-131	48
FB-91	185	FD-17	238	FD-411	43	FF-130	463	FF-458	790	FG-132	69
FB-92	185	FD-170	739	FD-412	43	FF-131	463	FF-459	791	FG-133	69

FG-134	712	FG-217	703	FG-87	73	FK-149	424	FK-248	402	FK-38	421
FG-135	712	FG-218	703	FG-88	69	FK-15	404	FK-249	402	FK-39	421
FG-136	712	FG-219	703	FG-89	73	FK-150	424	FK-25	421	FK-40	403
FG-137	712	FG-22	47	FG-9	71	FK-151	424	FK-250	402	FK-41	403
FG-138	76	FG-23	45	FG-90	706	FK-152	424	FK-251	402	FK-42	403
FG-139	76	FG-24	45	FG-91	706	FK-153	424	FK-252	401	FK-43	403
FG-14	61	FG-25	48	FG-92	84	FK-154	424	FK-253	770	FK-44	403
FG-140	58	FG-26	48	FG-93	706	FK-155	424	FK-254	402	FK-45	389
FG-141	58	FG-27	48	FG-94	705	FK-156	407	FK-255	402	FK-46	389
FG-142	58	FG-28	61	FG-95	705	FK-157	407	FK-256	402	FK-47	394
FG-143	706	FG-29	705	FG-96	77	FK-158	407	FK-257	402	FK-48	389
FG-144	78	FG-2SC	81	FG-97	77	FK-159	407	FK-258	402	FK-49	389
FG-145	711	FG-2TC	84	FG-98	712	FK-16	404	FK-26	421	FK-51	390
FG-146	706	FG-3	46	FG-99	71	FK-160	423	FK-260	401	FK-52	390
FG-147	58	FG-30	46	FK-01	420	FK-161	423	FK-261	401	FK-53	390
FG-148	58	FG-31	101	FK-02	420	FK-162	423	FK-262	401	FK-54	391
FG-149	79	FG-32	101	FK-03	420	FK-163	423	FK-263	401	FK-55	391
FG-15	44	FG-33	101	FK-04	420	FK-164	394	FK-27	389	FK-56	393
FG-150	101	FG-34	77	FK-05	420	FK-168	394	FK-270	808	FK-57	394
FG-151	705	FG-35	77	FK-06	420	FK-169	394	FK-271	808	FK-58	392
FG-152	70	FG-36	47	FK-07	420	FK-17	404	FK-272	808	FK-59	392
FG-153	712	FG-37	47	FK-08	420	FK-170	423	FK-28	389	FK-60	420
FG-154	712	FG-38	46	FK-09	500	FK-171	423	FK-280	772	FK-61	420
FG-155	709	FG-39	46	FK-1	53	FK-172	423	FK-281	772	FK-62	420
FG-156	49	FG-4	44	FK-10	53	FK-173	423	FK-282	772	FK-63	420
FG-157	49	FG-40	72, 476	FK-100	492	FK-176	393	FK-283	772	FK-64	420
FG-158	49	FG-41	70	FK-101	492	FK-177	417	FK-284	772	FK-65	420
FG-159	49	FG-42	70	FK-102	492	FK-178	417	FK-285	772	FK-66	420
FG-16	57	FG-43	59	FK-103	492	FK-179	393	FK-286	772	FK-67	420
FG-160	102	FG-44	59	FK-104	492	FK-18	404	FK-287	772	FK-68	420
FG-161	102	FG-45	706	FK-105	493	FK-180	423	FK-288	772	FK-69	420
FG-162	711	FG-46	706	FK-106	493	FK-181	423	FK-289	772	FK-70	416
FG-164	709	FG-47	57	FK-107	493	FK-182	423	FK-290	772	FK-71	416
FG-167	84	FG-48	57	FK-108	493	FK-183	423	FK-291	773	FK-72	417
FG-168	84	FG-49	57	FK-109	493	FK-188	418	FK-292	773	FK-73	417
FG-17	57	FG-5	44	FK-11	414	FK-189	418	FK-293	773	FK-74	417
FG-170	709	FG-50	51	FK-110	419	FK-19	404	FK-294	773	FK-75	416
FG-171	709	FG-51	51	FK-111	419	FK-190	423	FK-295	773	FK-76	416
FG-172	709	FG-52	51	FK-112	419	FK-191	423	FK-296	773	FK-77	416
FG-173	710	FG-53	51	FK-113	419	FK-192	423	FK-297	773	FK-78	416
FG-174	710	FG-54	51	FK-114	419	FK-193	408	FK-298	773	FK-79	417
FG-175	710	FG-55	51	FK-115	419	FK-194	408	FK-299	773	FK-80	401
FG-176	710	FG-56	51	FK-116	419	FK-195	408	FK-2TC	85	FK-81	392
FG-18	57	FG-57	51	FK-117	766	FK-196	408	FK-30	389	FK-82	401
FG-180	79	FG-58	47	FK-118	766	FK-197	422	FK-300	773	FK-83	416
FG-181	101	FG-59	704	FK-119	412	FK-198	422	FK-301	773	FK-84	416
FG-182	707	FG-60	63	FK-12	395	FK-1TC	85	FK-302	773	FK-85	413
FG-183	707	FG-61	63	FK-120	419	FK-2	53	FK-303	773	FK-86	413
FG-184	707	FG-63	97	FK-121	419	FK-20	389	FK-304	773	FK-87	53
FG-185	707	FG-64	97	FK-122	419	FK-200	426	FK-305	773	FK-88	53
FG-186	707	FG-65	706	FK-123	419	FK-201	425	FK-306	773	FK-90	491
FG-187	707	FG-66	52	FK-124	419	FK-202	425	FK-307	773	FK-91	491
FG-19C	52	FG-67	52	FK-125	419	FK-203	425	FK-308	773	FK-92	491
FG-19R	52	FG-68	52	FK-126	419	FK-204	425	FK-31	421	FK-93	393
FG-1SC	81	FG-69	52	FK-127	766	FK-205	426	FK-310	774	FK-94	413
FG-1TC	84	FG-6C	52	FK-128	766	FK-206	426	FK-311	774	FK-95	413
FG-2	44, 619	FG-6R	52	FK-13	414	FK-207	426	FK-312	774	FK-96	411, 571
FG-20	50	FG-7	71	FK-130	422	FK-208	426	FK-313	774	FK-97	411, 571
FG-200	702	FG-70	73	FK-131	422	FK-21	421	FK-314	774	FK-98	411, 571
FG-201	702	FG-71	73	FK-132	422	FK-211	425	FK-315	774	FK-99	411, 571
FG-202	702	FG-72	73	FK-133	767	FK-212	425	FK-316	774	FL-01	429
FG-203	702	FG-73	63	FK-134	768	FK-213	425	FK-317	774	FL-02	429
FG-204	702	FG-74	63	FK-135	767	FK-22	421	FK-318	775	FL-03	435
FG-205	702	FG-75	63	FK-136	418	FK-221	425	FK-319	775	FL-04	435
FG-206	702	FG-76	710	FK-137	418	FK-222	425	FK-32	421	FL-05	435
FG-207	702	FG-77	710	FK-138	418	FK-223	425	FK-320	775	FL-06	432
FG-208	702	FG-78	73	FK-139	418	FK-23	421	FK-321	775	FL-09	429
FG-209	703	FG-79	73	FK-14	414	FK-230	405	FK-322	775	FL-09R	429
FG-21	47	FG-8	71	FK-140	424	FK-232	405	FK-323	775	FL-100	441
FG-210	703	FG-80	74	FK-141	424	FK-234	405	FK-324	775	FL-101	441
FG-211	703	FG-81	74	FK-142	424	FK-236	406	FK-325	775	FL-102	441
FG-212	703	FG-82	74	FK-143	424	FK-238	406	FK-33	421	FL-103	441
FG-213	703	FG-83	74	FK-144	424	FK-24	421	FK-34	421	FL-104	430
FG-214	703	FG-84	74	FK-145	424	FK-240	406	FK-35	421	FL-105	430
FG-215	703	FG-85	74	FK-147	424	FK-243	414	FK-36	421	FL-106	430
FG-216	703	FG-86	73	FK-148	424	FK-244	414	FK-37	421	FL-107	431

FL-108	431	FL-215	446	FL-342	442	FL-98	437	FM-18	75	FM-49	55
FL-109	431	FL-216	446	FL-343	442	FL-99	437	FM-180	66	FM-4F	60
FL-10M	429	FL-22	434	FL-344	442	FM-1	60	FM-181	66	FM-4SC	81
FL-11	429	FL-220	446	FL-345	442	FM-10	54	FM-188	64	FM-5	64
FL-110	441	FL-221	446	FL-346	442	FM-100	99	FM-189	64	FM-50	86
FL-111	432	FL-222	446	FL-347	442	FM-100L	701	FM-19	75	FM-51	86
FL-112	431	FL-223	446	FL-348	442	FM-102	99	FM-190	98	FM-52	86
FL-113	432	FL-224	446	FL-349	442	FM-104	99	FM-191	98	FM-53	86
FL-114	435	FL-225	446	FL-35	434	FM-109	59	FM-192	98	FM-54	87
FL-115	435	FL-226	446	FL-350	442	FM-10L	83	FM-193	97	FM-55	87
FL-116	435	FL-23	435	FL-351	442	FM-10SC	713	FM-194	98	FM-56	87
FL-117	441	FL-230	445	FL-352	442	FM-11	62	FM-1F	60	FM-57	87
FL-118	435	FL-231	445	FL-353	442	FM-110	67	FM-15C	81	FM-58	88
FL-119	441	FL-232	445	FL-354	442	FM-111	67	FM-2	60	FM-59	88
FL-11R	429	FL-233	445	FL-355	442	FM-112	62	FM-20	76	FM-5SC	82
FL-12	429	FL-234	445	FL-356	442	FM-113	62	FM-201	90	FM-6	64
FL-126	435	FL-24	435	FL-357	442	FM-114	62	FM-202	91	FM-60	88
FL-127	435	FL-240	445	FL-359	442	FM-115	62	FM-203	90	FM-61	88
FL-128	770	FL-241	445	FL-36	437	FM-116	62	FM-204	91	FM-62	55
FL-12R	429	FL-242	445	FL-360	442	FM-117	62	FM-205	90	FM-63	55
FL-13	435	FL-243	445	FL-361	442	FM-118	85	FM-206	91	FM-64	708
FL-132	435	FL-244	445	FL-362	442	FM-119	85	FM-207	90	FM-65	55
FL-135	435	FL-250	448	FL-368	771	FM-12	59	FM-208	91	FM-65	708
FL-136	435	FL-251	448	FL-380	770	FM-120	61	FM-209	90	FM-66	89
FL-138	435	FL-252	448	FL-381	770	FM-121	61	FM-21	76	FM-67	89
FL-14	435	FL-253	433	FL-382	770	FM-122	61	FM-210	91	FM-68	89
FL-147	449	FL-254	433	FL-383	770	FM-123	707	FM-211	90	FM-69	89
FL-148	449	FL-255	433	FL-384	770	FM-124	707	FM-212	91	FM-6SC	82
FL-149	449	FL-256	433	FL-385	770	FM-125	707	FM-22	76	FM-7	56
FL-15	435	FL-257	433	FL-386	770	FM-126	711	FM-23	76	FM-70	61
FL-150	28, 491	FL-258	433	FL-387	770	FM-127	711	FM-24	64	FM-71	61
FL-151	28, 491	FL-259	433	FL-388	770	FM-13	62	FM-24SC	82	FM-72	56
FL-152	28, 491	FL-260	448	FL-40	435	FM-130	94	FM-25	64	FM-73	56
FL-153	28, 491	FL-261	448	FL-401	583	FM-131	94	FM-25SC	82	FM-74	61
FL-16	437	FL-262	448	FL-402	583	FM-132	94	FM-26	77	FM-75	61
FL-160	439	FL-263	438	FL-403	583	FM-133	94	FM-27	55	FM-76	67
FL-162	439	FL-264	438	FL-404	583	FM-134	95	FM-28	55	FM-77	67
FL-164	439	FL-265	438	FL-405	583	FM-135	95	FM-29	55	FM-78	67
FL-166	439	FL-266	438	FL-41	437	FM-136	95	FM-29L	83	FM-79	67
FL-168	439	FL-267	438	FL-410	583	FM-137	95	FM-29SC	82	FM-7L	83
FL-17	437	FL-268	438	FL-411	583	FM-139	96	FM-2F	60	FM-7SC	713
FL-170	439	FL-269	438	FL-412	583	FM-13SC	713	FM-2SC	81	FM-8	56
FL-172	439	FL-270	448	FL-42	437	FM-14	75	FM-3	60	FM-80	65
FL-174	439	FL-272	446	FL-43	437	FM-140	96	FM-30	55	FM-81	65
FL-176	439	FL-280	447	FL-44	437	FM-141	96	FM-30L	83	FM-82	65
FL-177	436	FL-281	447	FL-45	437	FM-142	96	FM-30SC	82	FM-83	65
FL-178	439	FL-282	447	FL-46	437	FM-143	96	FM-31	55	FM-84	65
FL-179	436	FL-283	447	FL-47	437	FM-145	88	FM-310	713	FM-85	65
FL-18	437	FL-284	447	FL-48	437	FM-146	88	FM-312	715	FM-86	66
FL-180	439	FL-285	447	FL-49	437	FM-147	88	FM-32	55	FM-87	66
FL-181	436	FL-29	437	FL-53	437	FM-148	86	FM-328	713	FM-88	66
FL-182	439	FL-30	434	FL-54	437	FM-149	86	FM-33	55	FM-89	66
FL-183	436	FL-307	443	FL-58	437	FM-15	75	FM-330	713	FM-8L	83
FL-184	436	FL-308	443	FL-59	440	FM-150	86	FM-331	713	FM-8SC	713
FL-185	436	FL-309	443	FL-60	440	FM-151	87	FM-335	715	FM-9	54
FL-186	436	FL-31	434	FL-61	440	FM-152	87	FM-339	715	FM-90	92
FL-187	436	FL-310	443	FL-62	440	FM-153	87	FM-34	55	FM-91	92
FL-188	436	FL-311	443	FL-63	441	FM-154	93	FM-343	715	FM-92	92
FL-189	436	FL-312	443	FL-64	441	FM-155	93	FM-35	54	FM-94	92
FL-190	445	FL-313	443	FL-81	441	FM-156	93	FM-350	85	FM-96	84, 92
FL-191	445	FL-314	443	FL-82	441	FM-157	93	FM-36	54	FM-97	92
FL-192	445	FL-315	443	FL-83	441	FM-159	93	FM-37	54	FM-98	92
FL-193	445	FL-316	443	FL-84	444	FM-16	75	FM-38	54	FM-99	92
FL-194	445	FL-32	437	FL-85	444	FM-160	89	FM-39	54	FM-9L	83
FL-198	425	FL-320	584	FL-86	444	FM-161	89	FM-3F	60	FM-9SC	713
FL-20	434	FL-322	584	FL-87	444	FM-162	89	FM-3SC	81	FO-10	468
FL-206	771	FL-323	584	FL-88	444	FM-163	89	FM-4	60	FO-100	454
FL-207	771	FL-324	584	FL-89	444	FM-166	708	FM-40	54	FO-101	454
FL-208	771	FL-33	434	FL-90	444	FM-17	75	FM-41	56	FO-102	454
FL-209	771	FL-334	450	FL-91	441	FM-171	708	FM-42	56	FO-103	454
FL-21	434	FL-335	450	FL-92	441	FM-172	708	FM-43	56	FO-104	454
FL-210	446	FL-336	450	FL-93	441	FM-173	708	FM-44	56	FO-105	484
FL-211	446	FL-337	450	FL-94	437	FM-174	97	FM-45	56	FO-106	780
FL-212	446	FL-34	437	FL-95	437	FM-175	77	FM-46	56	FO-107	776
FL-213	446	FL-340	442	FL-96	437	FM-176	707	FM-47	59	FO-108	474
FL-214	446	FL-341	442	FL-97	437	FM-177	707	FM-48	59	FO-109	776

FL-108	431	FL-215	446	FL-342	442	FL-98	437	FM-18	75	FM-49	55
FL-109	431	FL-216	446	FL-343	442	FL-99	437	FM-180	66	FM-4F	60
FL-10M	429	FL-22	434	FL-344	442	FM-1	60	FM-181	66	FM-4SC	81
FL-11	429	FL-220	446	FL-345	442	FM-10	54	FM-188	64	FM-5	64
FL-110	441	FL-221	446	FL-346	442	FM-100	99	FM-189	64	FM-50	86
FL-111	432	FL-222	446	FL-347	442	FM-100L	701	FM-19	75	FM-51	86
FL-112	431	FL-223	446	FL-348	442	FM-102	99	FM-190	98	FM-52	86
FL-113	432	FL-224	446	FL-349	442	FM-104	99	FM-191	98	FM-53	86
FL-114	435	FL-225	446	FL-35	434	FM-109	59	FM-192	98	FM-54	87
FL-115	435	FL-226	446	FL-350	442	FM-10L	83	FM-193	97	FM-55	87
FL-116	435	FL-23	435	FL-351	442	FM-10SC	713	FM-194	98	FM-56	87
FL-117	441	FL-230	445	FL-352	442	FM-11	62	FM-1F	60	FM-57	87
FL-118	435	FL-231	445	FL-353	442	FM-110	67	FM-15C	81	FM-58	88
FL-119	441	FL-232	445	FL-354	442	FM-111	67	FM-2	60	FM-59	88
FL-11R	429	FL-233	445	FL-355	442	FM-112	62	FM-20	76	FM-5SC	82
FL-12	429	FL-234	445	FL-356	442	FM-113	62	FM-201	90	FM-6	64
FL-126	435	FL-24	435	FL-357	442	FM-114	62	FM-202	91	FM-60	88
FL-127	435	FL-240	445	FL-359	442	FM-115	62	FM-203	90	FM-61	88
FL-128	770	FL-241	445	FL-36	437	FM-116	62	FM-204	91	FM-62	55
FL-12R	429	FL-242	445	FL-360	442	FM-117	62	FM-205	90	FM-63	55
FL-13	435	FL-243	445	FL-361	442	FM-118	85	FM-206	91	FM-64	708
FL-132	435	FL-244	445	FL-362	442	FM-119	85	FM-207	90	FM-65	55
FL-135	435	FL-250	448	FL-368	771	FM-12	59	FM-208	91	FM-65	708
FL-136	435	FL-251	448	FL-380	770	FM-120	61	FM-209	90	FM-66	89
FL-138	435	FL-252	448	FL-381	770	FM-121	61	FM-21	76	FM-67	89
FL-14	435	FL-253	433	FL-382	770	FM-122	67	FM-210	91	FM-68	89
FL-147	449	FL-254	433	FL-383	770	FM-123	707	FM-211	90	FM-69	89
FL-148	449	FL-255	433	FL-384	770	FM-124	707	FM-212	91	FM-6SC	82
FL-149	449	FL-256	433	FL-385	770	FM-125	707	FM-22	76	FM-7	56
FL-15	435	FL-257	433	FL-386	770	FM-126	711	FM-23	76	FM-70	61
FL-150	28, 491	FL-258	433	FL-387	770	FM-127	711	FM-24	64	FM-71	61
FL-151	28, 491	FL-259	433	FL-388	770	FM-13	62	FM-24SC	82	FM-72	56
FL-152	28, 491	FL-260	448	FL-40	435	FM-130	94	FM-25	64	FM-73	56
FL-153	28, 491	FL-261	448	FL-401	583	FM-131	94	FM-25SC	82	FM-74	61
FL-16	437	FL-262	448	FL-402	583	FM-132	94	FM-26	77	FM-75	61
FL-160	439	FL-263	438	FL-403	583	FM-133	94	FM-27	55	FM-76	67
FL-162	439	FL-264	438	FL-404	583	FM-134	95	FM-28	55	FM-77	67
FL-164	439	FL-265	438	FL-405	583	FM-135	95	FM-29	55	FM-78	67
FL-166	439	FL-266	438	FL-41	437	FM-136	95	FM-29L	83	FM-79	67
FL-168	439	FL-267	438	FL-410	583	FM-137	95	FM-29SC	82	FM-7L	83
FL-17	437	FL-268	438	FL-411	583	FM-139	96	FM-2F	60	FM-7SC	713
FL-170	439	FL-269	438	FL-412	583	FM-13SC	713	FM-25C	81	FM-8	56
FL-172	439	FL-270	448	FL-42	437	FM-14	75	FM-3	60	FM-80	65
FL-174	439	FL-272	446	FL-43	437	FM-140	96	FM-30	55	FM-81	65
FL-176	439	FL-280	447	FL-44	437	FM-141	96	FM-30L	83	FM-82	65
FL-177	436	FL-281	447	FL-45	437	FM-142	96	FM-30SC	82	FM-83	65
FL-178	439	FL-282	447	FL-46	437	FM-143	96	FM-31	55	FM-84	65
FL-179	436	FL-283	447	FL-47	437	FM-145	88	FM-310	713	FM-85	65
FL-18	437	FL-284	447	FL-48	437	FM-146	88	FM-312	715	FM-86	66
FL-180	439	FL-285	447	FL-49	437	FM-147	88	FM-32	55	FM-87	66
FL-181	436	FL-29	437	FL-53	437	FM-148	86	FM-328	713	FM-88	66
FL-182	439	FL-30	434	FL-54	437	FM-149	86	FM-33	55	FM-89	66
FL-183	436	FL-307	443	FL-58	437	FM-15	75	FM-330	713	FM-8L	83
FL-184	436	FL-308	443	FL-59	440	FM-150	86	FM-331	713	FM-8SC	713
FL-185	436	FL-309	443	FL-60	440	FM-151	87	FM-335	715	FM-9	54
FL-186	436	FL-31	434	FL-61	440	FM-152	87	FM-339	715	FM-90	92
FL-187	436	FL-310	443	FL-62	440	FM-153	87	FM-34	55	FM-91	92
FL-188	436	FL-311	443	FL-63	441	FM-154	93	FM-343	715	FM-92	92
FL-189	436	FL-312	443	FL-64	441	FM-155	93	FM-35	54	FM-94	92
FL-190	445	FL-313	443	FL-81	441	FM-156	93	FM-350	85	FM-96	84, 92
FL-191	445	FL-314	443	FL-82	441	FM-157	93	FM-36	54	FM-97	92
FL-192	445	FL-315	443	FL-83	441	FM-159	93	FM-37	54	FM-98	92
FL-193	445	FL-316	443	FL-84	444	FM-16	75	FM-38	54	FM-99	92
FL-194	445	FL-32	437	FL-85	444	FM-160	89	FM-39	54	FM-9L	83
FL-198	425	FL-320	584	FL-86	444	FM-161	89	FM-3F	60	FM-9SC	713
FL-20	434	FL-322	584	FL-87	444	FM-162	89	FM-3SC	81	FO-10	468
FL-206	771	FL-323	584	FL-88	444	FM-163	89	FM-4	60	FO-100	454
FL-207	771	FL-324	584	FL-89	444	FM-166	708	FM-40	54	FO-101	454
FL-208	771	FL-33	434	FL-90	444	FM-17	75	FM-41	56	FO-102	454
FL-209	771	FL-334	450	FL-91	441	FM-171	708	FM-42	56	FO-103	454
FL-21	434	FL-335	450	FL-92	441	FM-172	708	FM-43	56	FO-104	454
FL-210	446	FL-336	450	FL-93	441	FM-173	708	FM-44	56	FO-105	484
FL-211	446	FL-337	450	FL-94	437	FM-174	97	FM-45	56	FO-106	780
FL-212	446	FL-34	437	FL-95	437	FM-175	77	FM-46	56	FO-107	776
FL-213	446	FL-340	442	FL-96	437	FM-176	707	FM-47	59	FO-108	474
FL-214	446	FL-341	442	FL-97	437	FM-177	707	FM-48	59	FO-109	776

GF-40	679	GS-16	35	KI-209	499	KI-69	495	LB-365	34	LS-239	502
GF-41	674	GS-18	35	KI-210	499	KI-70	495	LB-366	34	LS-24	520
GF-42	674	GS-19	798	KI-211	499	KI-72	495	LB-367	34	LS-240	523
GF-43	670	GS-20	23	KI-212	499	KI-74	495	LB-368	34	LS-241	502
GF-44	665	GS-21	23	KI-22	494	KI-75	495	LB-369	34	LS-242	523
GF-45	670	GS-22	23	KI-220	495	KI-76	495	LB-40	35	LS-244	523
GF-46	675	GS-23	23, 104	KI-221	495	KI-77	495	LG-1	50	LS-25	520
GF-47	670	GS-24	23, 104	KI-222	495	KI-78	495	LG-15C	80	LS-26	520
GF-48	667	GS-25	23, 104	KI-223	495	KI-80	495	LG-25C	80	LS-27	520
GF-49	667	GS-26	23, 104	KI-230	498	KI-82	495	LG-6	50	LS-28	520
GF-50	667	GS-27	23, 104	KI-231	498	KI-85	495	LK-1	48	LS-29	520
GF-51	668	GS-28	23, 104	KI-232	498	KI-90	495	LK-10	709	LS-30	520
GF-52	668	GS-29	23, 104	KI-238	498	KI-99	494	LK-12	709	LS-300	414
GF-53	672	GS-30	697	KI-240	498	KO-1	381	LK-2	53	LS-301	414
GF-54	662	GS-31	697	KI-242	498	KO-11	565	LK-3	48	LS-302	414
GF-55	672	GS-40	24	KI-244	498	KO-12	565	LK-4	53	LS-303	414
GF-56	672	GS-42	24	KI-246	498	KO-14	383	LS-06	22, 516	LS-310	528
GF-57	672	GS-44	24	KI-248	498	KO-15	383	LS-07	22, 516	LS-311	528
GF-58	672	GS-46	24	KI-25	494	KO-16	383	LS-08	22, 516	LS-312	528
GF-59	672	GS-48	24	KI-252	496	KO-17	383	LS-09	22, 516	LS-313	528
GF-60	674	GS-50	24	KI-254	496	KO-18	382	LS-10	519	LS-314	528
GF-61	674	KI-00	494	KI-256	496	KO-19	382	LS-100	500	LS-315	528
GF-62	681	KI-01	494	KI-258	496	KO-2	381	LS-101	530	LS-316	529
GF-63	670	KI-02	494	KI-260	496	KO-20	395	LS-102	530	LS-317	529
GF-64	681	KI-10	516	KI-262	496	KO-21	382	LS-103	530	LS-318	529
GF-65	670	KI-100	494	KI-264	496	KO-22	395	LS-104	530	LS-32	519
GF-66	681	KI-102	494	KI-280	496	KO-23	395	LS-106	500	LS-320	527
GF-67	670	KI-114	494	KI-282	496	KO-24	382	LS-11	519	LS-321	527
GF-69	674	KI-115	494	KI-284	496	KO-25	382	LS-110	499	LS-322	527
GF-70	674	KI-116	494	KI-286	496	KO-26	382	LS-112	518	LS-323	527
GF-71	667	KI-117	494	KI-288	496	KO-27	382	LS-113	518	LS-324	527
GF-72	667	KI-118	494	KI-290	496	KO-28	382	LS-114	518	LS-325	527
GF-75	661	KI-120	494	KI-293	498	KO-29	382	LS-115	518	LS-326	527
GF-76	661	KI-122	494	KI-294	498	KO-30	397	LS-116	526	LS-329	527
GF-77	661	KI-125	494	KI-295	498	KO-31	756	LS-117	526	LS-33	519
GF-78	661	KI-130	494	KI-296	498	KO-32	756	LS-119	526	LS-330	527
GF-80	673	KI-14	494	KI-297	498	KO-33	756	LS-12	519	LS-40	521
GF-81	673	KI-15	494	KI-298	498	KO-34	384	LS-120	523	LS-400	531
GF-82	673	KI-16	494	KI-30	494	KO-35	384	LS-121	526	LS-405	531
GF-83	673	KI-160	496	KI-300	497	KO-36	384	LS-122	530	LS-406	531
GF-84	673	KI-161	496	KI-301	497	KO-37	384	LS-123	530	LS-41	521
GF-85	678	KI-17	494	KI-306	500	KO-38	397	LS-124	526	LS-410	531
GF-86	678	KI-175	497	KI-307	500	KO-39	395	LS-125	522	LS-42	521
GF-87	678	KI-176	497	KI-308	500	KO-40	385	LS-126	522	LS-43	521
GF-88	678	KI-177	497	KI-322	499	KO-41	385	LS-127	529	LS-44	521
GF-89	684	KI-178	497	KI-330	498	KO-42	385	LS-128	529	LS-45	521
GF-90	684	KI-179	497	KI-331	498	KO-43	385	LS-13	519	LS-46	521
GF-92	676	KI-18	494	KI-332	498	KO-44	385	LS-135	522	LS-47	521
GF-93	676	KI-180	497	KI-333	498	KO-46	397	LS-136	522	LS-48	521
GF-94	676	KI-181	497	KI-334	498	KO-47	383	LS-137	522	LS-49	521
GF-96	676	KI-182	497	KI-335	498	KO-48	383	LS-138	522	LS-50	521
GF-97	676	KI-183	497	KI-336	498	KO-49	383	LS-139	522	LS-76	530
GF-98	666	KI-184	497	KI-40	494	KO-50	383	LS-14	519	LS-78	530
GF-99	666	KI-185	497	KI-41	494	KO-60	289	LS-140	522	LS-80	524
GFC	49	KI-186	497	KI-42	494	KO-78	808	LS-15	519	LS-81	524
GFC-S	45	KI-187	497	KI-43	494	LB-10	33	LS-16	519	LS-82	524
GFC-SC	80	KI-188	497	KI-44	494	LB-11	33	LS-17	519	LS-83	524
GFC-TC	84	KI-189	497	KI-45	494	LB-12	33	LS-20	520	LS-84	524
GFR	49	KI-190	497	KI-46	494	LB-12D	33	LS-200	517	LS-85	524
GFR-S	45	KI-191	497	KI-47	494	LB-12D	756	LS-201	517	LS-90	525
GFR-SC	80	KI-192	497	KI-48	494	LB-13	33	LS-202	517	LS-91	525
GFR-TC	84	KI-193	497	KI-49	494	LB-15	33	LS-21	520	LS-92	525
GFS	50	KI-194	497	KI-50	496	LB-15A	756	LS-22	520	LS-93	525
GFS-SC	80	KI-195	497	KI-51	496	LB-15C	756	LS-227	501	LS-94	518
GS-01	697	KI-196	497	KI-52	496	LB-18	33	LS-228	501	LS-95	518
GS-02	696	KI-197	497	KI-53	496	LB-20	33	LS-229	501	LS-96	518
GS-03	696	KI-198	497	KI-54	496	LB-21	33	LS-23	520	LS-97	518
GS-04	696	KI-199	497	KI-55	496	LB-22	33	LS-230	503	LS-98	518
GS-05	697	KI-20	494	KI-56	496	LB-23	33	LS-231	501, 502, 503	LX-102	513
GS-06	696	KI-202	499	KI-57	496	LB-24	33	LS-232	503	LX-103	513
GS-07	697	KI-203	499	KI-58	496	LB-25	33	LS-233	501	LX-104	514
GS-09	697	KI-204	499	KI-60	495	LB-36	33	LS-234	503	LX-105	514
GS-10	696	KI-205	499	KI-61	495	LB-361	34	LS-235	527	LX-106	514
GS-11	696	KI-206	499	KI-62	495	LB-362	34	LS-236	501, 502	LX-107	515
GS-13	798	KI-207	499	KI-63	495	LB-363	34	LS-237	502	LX-108	473
GS-14	798	KI-208	499	KI-64	495	LB-364	34	LS-238	502	LX-109	473

LX-110	473	MF-128	111	MF-88	615	NK-43	590	OL-159	799	OM-110	542
LX-111	780	MF-129	111	MF-93	107, 617	NK-44	591	OL-16	681	OM-111	542
LX-112	475	MF-13	614	MF-94	107, 617	NK-45	591, 620	OL-17	681	OM-112	542
LX-113	532	MF-14	614	MF-97	618	NK-46	591	OL-18	681	OM-113	542
LX-114	532	MF-142T	111	MO-15	401	NK-47	591	OL-19	682	OM-114	542
LX-115	532	MF-143T	111	MP-200	813	NK-48	592, 618	OL-20	593, 618	OM-12	7
LX-116	780	MF-144T	111	MP-201	617	NK-49	599	OL-22	681	OM-13	7
LX-120	533	MF-145T	111	MP-203	618	NK-50	29	OL-23	681	OM-136	6, 539
LX-121	533	MF-146T	111	MP-204	618	NK-51	29	OL-24	681	OM-137	6, 539
LX-122	533	MF-147T	111	MP-206	618	NK-52	29	OL-25	682	OM-138	6, 539
LX-123	533	MF-148	111	MP-207	619	NK-53	29	OL-26	682	OM-139	6, 539
LX-125	512	MF-149	111	MP-208	619	NK-54	29	OL-27	682	OM-14	7
LX-130	509	MF-15	614	MP-209	620	NK-55	29	OL-28	682	OM-140	541
LX-131	509	MF-150	596	MP-210	617	NK-56	29	OL-29	682	OM-141	541
LX-134	508	MF-151	596	NK-03	591	NK-57	29	OL-30	228, 681	OM-142	541
LX-135	508	MF-16	614	NK-04	591	NK-59	592, 620	OL-31	228, 681	OM-143	541
LX-136	508	MF-17	614	NK-05	592	NK-60	594, 617	OL-32	228, 681	OM-144	541
LX-137	508	MF-19	614	NK-06	27, 589	NK-61	594	OL-33	228, 681	OM-145	541
LX-138	509	MF-20	614	NK-07	589	NK-62	594	OL-34	682	OM-146	541
LX-139	509	MF-21	614	NK-08	27, 589	NK-63	594	OL-36	682	OM-15	7
LX-140	509	MF-22	614	NK-09	589, 618	NK-64	594	OL-37	682	OM-16	4
LX-141	509	MF-23	614	NK-1	34	NK-65	594	OL-38	682	OM-160	539
LX-150	783	MF-231	596	NK-1	756	NK-66	594	OL-39	682	OM-161	539
LX-151	783	MF-232	596	NK-10	27, 589, 620	NK-67	594	OL-40	377	OM-162	539
LX-160	477	MF-24	614	NK-100	28	NK-69	594, 619	OL-41	378, 684	OM-163	539
LX-161	477	MF-245	596	NK-101	28	NK-70	594	OL-42	378, 684	OM-164	539
LX-162	477	MF-246	596	NK-102	28	NK-71	594	OL-43	378, 684	OM-17	4
LX-163	477	MF-25	614	NK-105	592	NK-73	594	OL-44	378, 684	OM-170	541
LX-164	477	MF-26	614	NK-107	592	NK-74	589, 618	OL-45	378, 684	OM-171	541
LX-165	477	MF-27	614	NK-108	592	NK-75	591, 618	OL-46	378, 684	OM-172	541
LX-166	477	MF-278	596	NK-109	592	NK-76	589	OL-47	378, 684	OM-173	541
LX-80	507	MF-279	596	NK-11	590	NK-77	594	OL-48	378, 684	OM-174	541
LX-82	510	MF-28	614	NK-110	592, 620	NK-78	594	OL-49	378, 684	OM-18	4
LX-92TC	510	MF-29	614	NK-111	592, 620	NK-79	598, 618	OL-50	593, 620	OM-181	769
LX-95TC	510	MF-30	614	NK-112	592	NK-80	598, 617	OL-51	593, 620	OM-182	769
LX-96TC	510	MF-31	614	NK-12	35, 617, 620	NK-82	598	OL-52	593, 620	OM-183	769
LX-99	510	MF-32	614	NK-13	590	NK-83	598	OL-53	593, 618, 620	OM-184	769
MA-6	9	MF-320	132	NK-131	599	NK-84	598, 620	OL-54	593	OM-185	769
MA-B1	30	MF-33	614	NK-14	27, 590	NK-85	35	OL-55	593	OM-186	769
MA-B10	32	MF-34	612, 619	NK-15	589	NK-86	598	OL-56	593	OM-187	769
MA-B11	31	MF-35	612	NK-16	27, 590	NK-87	594	OL-57	593	OM-19	4
MA-B12	31	MF-36	612	NK-17	589	NK-88	594	OL-58	593	OM-20	560
MA-B15	31	MF-37	612	NK-18	27, 590, 617	NK-89	594	OL-59	799	OM-201	326
MA-B2	30	MF-38	612	NK-19	589	NK-90	28	OL-63	682	OM-202	326
MA-B3	30	MF-40	612, 619	NK-2	34	NK-91	28	OL-64	682	OM-203	326
MA-B3L	31	MF-41	612	NK-2	756	NK-92	599	OL-66	680	OM-204	326
MA-B3M	30	MF-42	612	NK-20	27, 590	NK-93	589, 618, 620	OL-67	680	OM-208	326
MA-B4	32	MF-43	612	NK-21	591	NK-94	592	OL-68	680	OM-209	326
MA-B4L	32	MF-44	612	NK-22	591	NK-95	28	OL-69	680	OM-210	326
MA-B5	31	MF-46	613	NK-23	591, 617	NK-96	28	OL-86	683	OM-211	326
MA-B6	32	MF-47	613	NK-24	591	NK-97	592, 618	OL-87	683	OM-22	560
MA-B7	30	MF-48	613	NK-25	591	NK-98	592	OL-88	683	OM-23	560
MA-B7K	30	MF-49	613	NK-26	591	NK-99	592	OL-89	683	OM-24	560
MA-B8	30	MF-50	613	NK-27	590	OL-01	378, 680	OL-90	683	OM-25	559
MA-B9	30	MF-52	613	NK-28	590, 617	OL-02	378, 680	OL-91	683	OM-26	560
MEAD	395	MF-53	613	NK-29	590	OL-03	378, 680	OL-92	683	OM-27	559
MF-04	107	MF-54	613	NK-3	756	OL-04	378, 680	OL-93	683	OM-28	559
MF-101	123	MF-55	613	NK-30	27	OL-05	378, 680	OL-94	683	OM-29	559
MF-101T	718	MF-56	613	NK-31	29	OL-06	682	OL-95	683	OM-30	7, 143
MF-102	123	MF-58	617	NK-32	27	OL-07	682	OL-96	683	OM-32	561
MF-102T	718	MF-64	617	NK-33	29	OL-08	682	OL-97	683	OM-34	561
MF-103	123	MF-73	613	NK-34	27	OL-09	682	OL-98	683	OM-36	561
MF-104	123	MF-74	613	NK-35	29	OL-10	682	OL-99	683	OM-38	561
MF-105	123	MF-75	613	NK-36	27	OL-11	682	OM-04	4	OM-39	559
MF-106	717	MF-76	613	NK-37	29	OL-13	681	OM-05	4	OM-40	6, 537
MF-107	717	MF-77	616, 617	NK-38	27	OL-14	681	OM-06	544	OM-41	6, 537
MF-110	108	MF-78	616	NK-39	589	OL-15	681	OM-07	4	OM-42	537
MF-111	108	MF-79	616, 617, 619	NK-398	618	OL-150	799	OM-08	544	OM-44	8, 143
MF-112	108	MF-80	616, 619	NK-40	27	OL-151	799	OM-10	7, 143	OM-45	8, 143
MF-113	108	MF-81	107, 616	NK-401	595	OL-152	799	OM-100	543	OM-46	8, 143
MF-114	108	MF-82	107, 616	NK-403	595	OL-153	799	OM-101	326	OM-47	8, 143
MF-115	108	MF-83	616	NK-41	590	OL-154	799	OM-102	326	OM-50	290, 539
MF-124	111	MF-84	616	NK-42	590	OL-155	799	OM-103	326	OM-52	290, 539
MF-125	111	MF-85	615	NK-420	598	OL-156	799	OM-104	326	OM-55	539
MF-126	111	MF-86	615	NK-421	598	OL-157	799	OM-105	326	OM-58	539
MF-127	111	MF-87	615	NK-422	598	OL-158	799	OM-11	7, 143	OM-60	6, 537

OM-62	6, 537	P-138	160	P-207	144	P-280	724	P-52	223	PF-44	276
OM-74	538	P-139	160	P-208	158	P-281	724	P-53	145	PF-46	277
OM-75	538	P-14	166	P-209	158	P-282	724	P-54	155	PF-48	277
OM-76	538	P-140	166	P-21	156	P-283	724	P-55	155	PF-49	277
OM-77	538	P-141	166	P-210	162	P-284	724	P-56	154	PF-50	277
OM-80	325, 543	P-142	161	P-211	159	P-285	723	P-57	154	PF-51	277
OM-81	325, 543	P-143	161	P-212	159	P-286	723	P-58	154	PF-52	277
OM-82	325, 543	P-144	161	P-213	159	P-287	723	P-59	154	PF-53	275
OM-85	325	P-145	161	P-214	159	P-288	723	P-60	139	PF-54	275
OM-87	325, 543	P-146	161	P-215	162	P-289	727	P-61	151	PF-55	275
OM-88	325, 543	P-147	161	P-216	162	P-29	154	P-62	151	PF-56	275
OM-90	538	P-148	161	P-217	162	P-298	731	P-63	151	PF-57	275
OM-92	538	P-149	161	P-218	171	P-299	731	P-64	151	PF-58	275
OM-93	769	P-15	160	P-219	171	P-30	156	P-65	158	PF-59	275
OM-94	769	P-150	160	P-22	156	P-300	732	P-66	158	PF-60	278
OM-95	769	P-151	167	P-220	174	P-301	728	P-67	158	PF-61	278
OM-98	543	P-152	167	P-221	154	P-302	728	P-68	150	PF-62	277
OM-99	326	P-153	167	P-222	165	P-303	728	P-69	150	PF-63	277
OR-11	19	P-154	167	P-223	165	P-304	728	P-70	157	PF-64	277
OR-12	20	P-155	167	P-224	629	P-305	728	P-71	157	PF-65	278
OR-13	19	P-156	167	P-225	629	P-306	728	P-72	157	PF-66	277
OR-14	20	P-157	161	P-226	629	P-307	732	P-73	157	PF-67	277
OR-15	19	P-158	161	P-227	168	P-308	725	P-74	157	PF-68	277
OR-16	21	P-159	161	P-228	168	P-309	725	P-75	157	PF-69	277
OR-17	19	P-16	151	P-229	168	P-31	156	P-76	157	PF-7	276
OR-18	21	P-160	161	P-23	156	P-310	725	P-77	157	PF-70	279
OR-19	19	P-161	161	P-230	152	P-311	725	P-78	157	PF-71	279
OR-25	22	P-162	161	P-231	152	P-312	725	P-79	155	PF-72	279
OR-32	811	P-163	161	P-232	152	P-313	725	P-81	151	PF-73	278
OR-33	811	P-164	161	P-233	152	P-314	729	P-82	151	PF-80	275
OR-40	22	P-165	161	P-234	152	P-315	729	P-84	155	PF-81	275
OR-42	22	P-166	161	P-235	152	P-316	729	P-85	155	PF-82	275
P-0	9	P-167	161	P-236	152	P-317	728	P-86	151	PF-83	275
P-00	9	P-168	161	P-237	152	P-318	726	P-87	151	PF-85	275
P-01	9	P-169	161	P-238	152	P-319	726	P-89	155	PF-88	278
P-02	9	P-17	150	P-239	152	P-32	156	P-91	150, 620	PH-100	740
P-03	9	P-170	160	P-24	156	P-320	726	P-92	150	PH-101	255
P-04	9	P-171	160	P-240	152	P-321	726	P-93	150	PH-102	255
P-05	9	P-172	160	P-241	152	P-322	726	P-94	150	PH-103	255
P-06	9	P-173	160	P-242	152	P-323	725	P-95	149	PH-104	255
P-07	174	P-174	163	P-243	152	P-324	731	P-96	149	PH-106	254
P-08	139	P-175	163	P-244	152	P-325	721	P-97	149	PH-107	254
P-09	139	P-176	163	P-245	152	P-326	729	P-98	149	PH-108	254
P-10	168	P-177	163	P-246	155	P-327	729	P-99	145, 629	PH-109	740
P-100	145	P-178	163	P-247	155	P-328	729	PF-10	277	PH-110	255
P-101	149	P-179	164	P-248	158	P-329	729	PF-13	277	PH-111	255
P-102	149	P-18	154	P-249	158	P-33	156	PF-14	276	PH-112	255
P-103	144	P-180	164	P-25	156	P-330	731	PF-15	276	PH-113	255
P-104	158	P-181	164	P-250	153	P-331	725	PF-16	799	PH-114	255
P-105	145	P-182	223	P-251	153	P-332	730	PF-17	275	PH-115	740
P-11	168	P-183	223	P-252	153	P-34	156	PF-18	275	PH-116	740
P-111	620	P-184	223	P-253	153	P-35	156	PF-19	275	PH-117	251
P-113	144	P-185	223	P-254	153	P-36	156	PF-20	276	PH-118	251
P-114	144	P-186	223	P-255	153	P-37	156	PF-21	276	PH-119	251
P-115	145	P-187	223	P-256	153	P-38	154	PF-22	276	PH-120	251
P-116	729	P-188	223	P-257	153	P-39	154	PF-23	276	PH-121	251
P-118	145	P-189	163	P-258	153	P-40	157	PF-24	275	PH-122	251
P-119	145	P-19	154	P-259	153	P-401	737	PF-25	276	PH-123	251
P-12	166	P-190	163	P-26	156	P-402	737	PF-26	276	PH-124	251
P-120	149	P-191	162	P-260	153	P-403	737	PF-27	276	PH-125	251
P-121	149	P-192	162	P-261	153	P-404	737	PF-28	276	PH-127	252
P-122	151	P-193	162	P-262	153	P-405	737	PF-29	276	PH-128	252
P-123	164	P-194	162	P-263	153	P-406	737	PF-30	276	PH-129	252
P-125	164	P-195	162	P-264	723	P-407	737	PF-31	276	PH-130	252
P-127	168	P-196	162	P-265	723	P-408	737	PF-32	276	PH-131	252
P-128	168	P-197	162	P-266	725	P-41	157	PF-33	276	PH-132	254
P-129	731	P-198	165	P-267	725	P-42	157	PF-34	276	PH-133	254
P-13	166	P-199	165	P-27	156	P-43	157	PF-35	276	PH-134	254
P-130	166	P-20	156	P-273	723	P-44	157	PF-36	276	PH-135	740
P-131	166	P-200	158	P-274	724	P-45	157	PF-37	276	PH-136	741
P-132	145	P-201	159	P-275	724	P-46	157	PF-38	276	PH-137	741
P-133	145	P-202	159	P-276	723	P-47	157	PF-39	277	PH-138	741
P-134	145	P-203	159	P-277	724	P-48	157	PF-40	277	PH-139	741
P-135	149	P-204	159	P-278	724	P-49	155	PF-41	277	PH-140	739
P-136	160	P-205	159	P-279	724	P-50	145	PF-42	277	PH-141	739
P-137	160	P-206	159	P-28	154	P-51	145	PF-43	277	PH-142	739

PH-143	739	PO-40	249	TR-45	373
PH-144	739	PO-46	249	TR-46	373
PH-145	739	PO-47	249	TR-47	376
PH-38	243	PO-48	249	TR-48	376
PH-39	243	PO-50	260	TR-49	376
PH-40	244	PO-51	260	TR-50	376
PH-41	244	PO-52	260	TR-51	373
PH-42	244	PO-55	261	TR-52	373
PH-43	244	PO-56	261	TR-53	373
PH-44	244	PO-59	247	TR-54	373
PH-45	244	PO-60	248	TR-55	373
PH-46	245	PO-65	248	TR-56	373
PH-47	245	PO-66	260	TR-57	373
PH-48	243	PO-67	249	TR-61	374
PH-49	245	PO-71	248	TR-62	374
PH-52	244	PO-74	249	TR-63	374
PH-53	250	PO-75	249	TR-64	374
PH-54	250	PO-78	248	TR-68	377
PH-55	511	PO-79	248	TR-69	377
PH-56	511	PO-80	248	TR-76	490
PH-57	511	PO-81	248	TR-77	490
PH-58	252, 511	PO-82	260	TR-78	490
PH-59	251	PO-83	260	TS-101	695
PH-61	243	PO-84	260	TS-102	695
PH-62	243	PO-85	261	TS-103	695
PH-63	243	PO-86	261	TS-104	695
PH-64	243	PO-87	261	TS-50	676
PH-65	250	PO-88	249	VF-98	515
PH-66	250	PO-89	247	VF-98M	515
PH-67	740	PO-90	248	VH-20	507
PH-68	250	PO-91	248	VH-21	507
PH-69	250	PO-92	260	VH-23	507
PH-70	244	PO-94	249	VH-25	507
PH-71	250	PO-96	741	VH-40	512
PH-72	251	PO-97	253	VPC-10	691
PH-73	250	PO-97L	741	VPC-12	691
PH-74	244	PO-99	253	VPC-6	691
PH-75	251	PO-99L	741	VPC-8	691
PH-76	251	SC-1	100	VS-20	693
PH-77	252	SC-10	100	VS-26	693
PH-78	244	SC-12	100	VS-30	693
PH-79	254	SC-13	705	WEST	395
PH-80	258	SC-14	701	WG-10	381
PH-81	258	SC-15	701	WG-12	381
PH-82	258	SC-16	705	WG-14	381
PH-83	258	SC-2	100		
PH-84	258	SC-5	100		
PH-85	254	SC-9	705		
PH-86	256	SL-1	415		
PH-87	256	SL-2	415		
PH-88	256	TG-10	434		
PH-89	256	TG-11	434		
PH-91	257	TG-12	434		
PH-93	257	TG-20	434		
PH-94	257	TG-21	434		
PH-95	256	TG-22	434		
PH-96	256	TG-23	434		
PH-97	256	TG-40	434		
PH-98	256	TG-41	434		
PH-99	740	TR-20	373		
PO-110	260	TR-21	373		
PO-120	259	TR-22	373		
PO-121	259	TR-23	373		
PO-122	259	TR-24	373		
PO-123	259	TR-25	373		
PO-124	259	TR-26	373		
PO-125	259	TR-30	375		
PO-126	259	TR-32	375		
PO-127	259	TR-33	375		
PO-128	259	TR-34	375		
PO-129	259	TR-35	375		
PO-34	742	TR-40	373		
PO-35	742	TR-41	373		
PO-36	742	TR-42	373		
PO-37	247	TR-43	373		
PO-38	247	TR-44	373		