

01 |

Extracting Forceps
Zahnzangen
Daviers
Pinzas de extracción
Pinze da estrazione

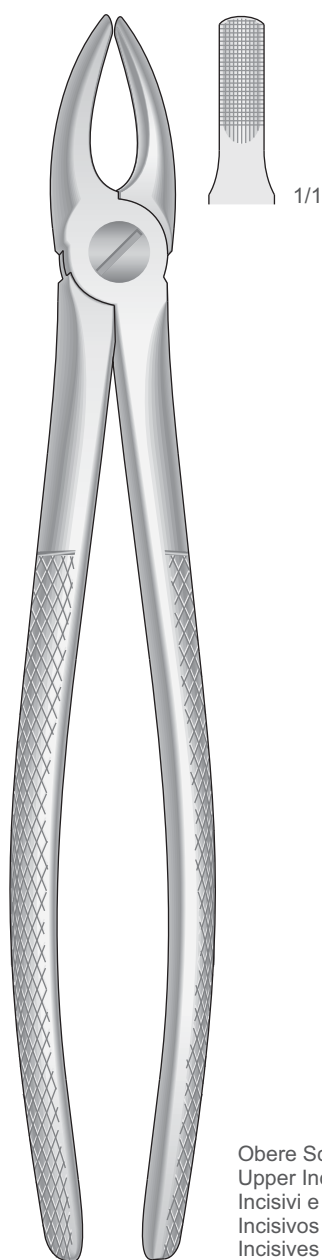

Zahnzangen, Englische Form
Extracting Forceps, English Pattern
Pinze per estrazione, Forma Inglese
Pinzas da extracción, Forma Inglesa
Daviers, Forme Anglaise



1
Fig. 1

Obere Schneide- und Eckzähne
Upper Incisors and cuspids
Incisivi e canini superiori
Incisivos y caninos superiores
Incisives et canines supérieures

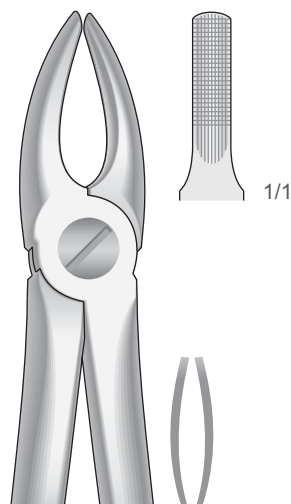

2
Fig. 2

Obere Schneide- und Eckzähne
Upper Incisors and cuspids
Incisivi e canini superiori
Incisivos y caninos superiores
Incisives et canines supérieures

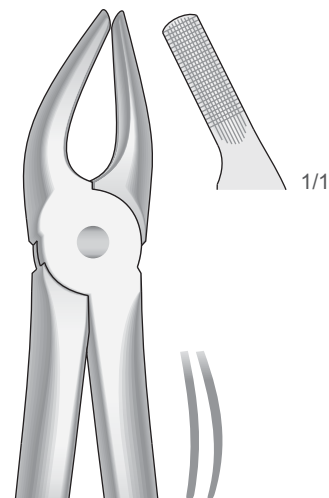

7
Fig. 7

Obere Prämolaren
Upper premolars
Premolari superiori
Premolares superiores
Prémolaires supérieures

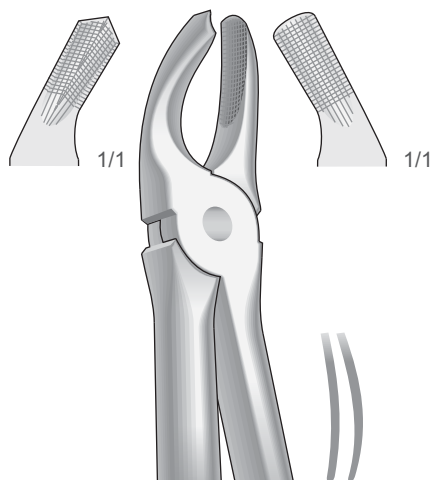

17
Fig. 17

Obere Molaren, rechts
Upper molars, right
Molari superiori, destra
Molares superiores, derechos
Molaires supérieures, droites

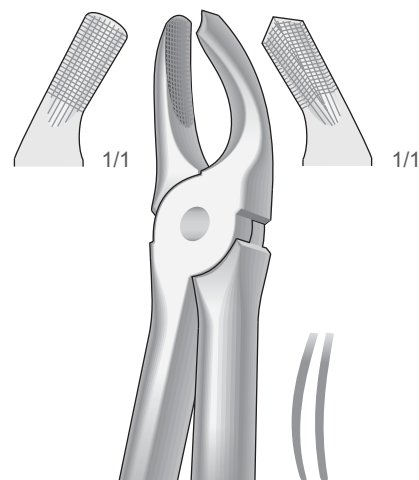

18
Fig. 18

Obere Molaren, links
Upper molars, left
Molari superiori, sinistra
Molares superiores, izquierdos
Molaires supérieures, gauches

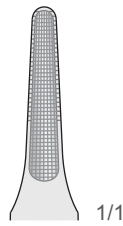
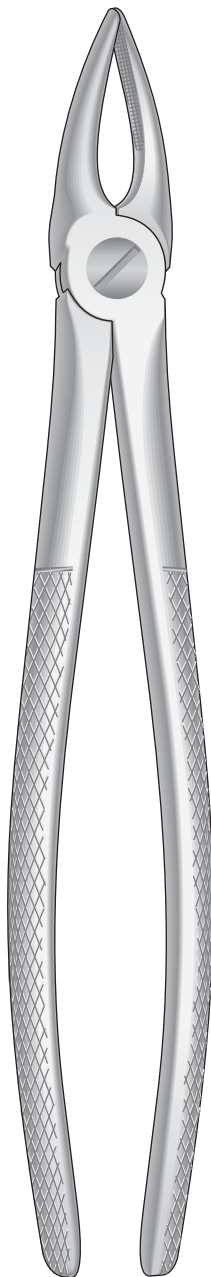

1/1

Obere Wurzeln und Schneidezähne
Upper Roots and incisors
Radici e incisivi superiori
Raíces y incisivos superiores
Racines et incisives supérieures

29
Fig. 29

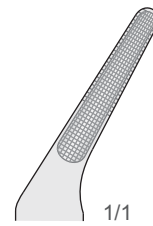

1/1

Obere Wurzeln
Upper Roots
Radici superiori
Raíces superiores
Racines supérieures

30
Fig. 30



Zahnzangen, Englische Form
Extracting Forceps, English Pattern
Pinze per estrazione, Forma Inglese
Pinzas da extracción, Forma Inglesa
Daviers, Forme Anglaise

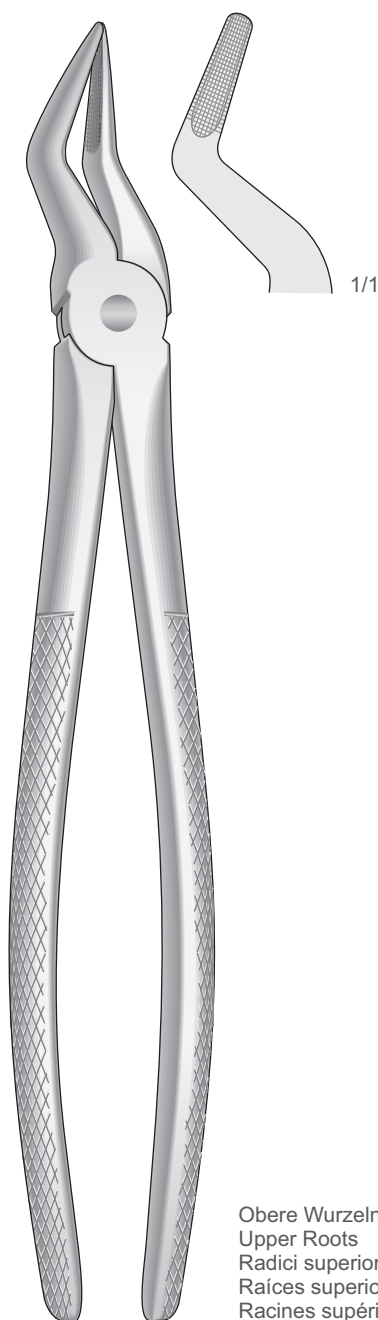

51
Fig. 51

Obere Wurzeln
Upper Roots
Radici superiori
Raíces superiores
Racines supérieures

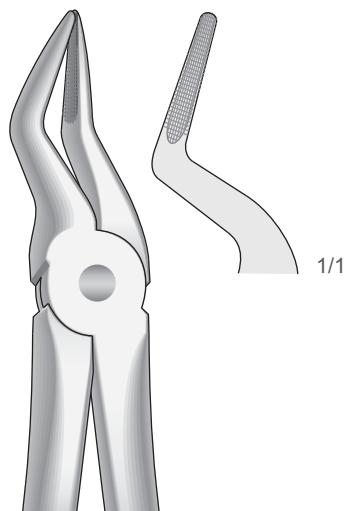

51A
Fig. 51A

Obere Wurzeln
Upper Roots
Radici superiori
Raíces superiores
Racines supérieures

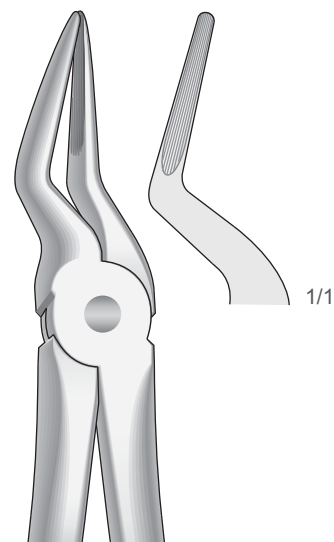

51L
Fig. 51AL

Obere Wurzeln
Upper Roots
Radici superiori
Raíces superiores
Racines supérieures

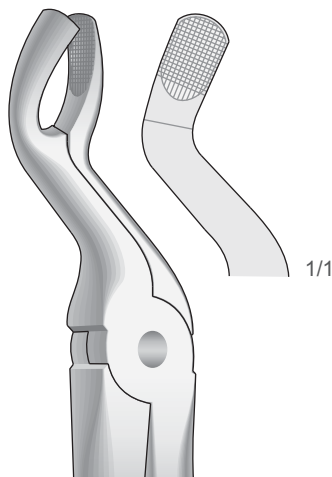

67A
Fig. 67A

Obere Dritte Molaren - Für Obere Weisheitszähne
Upper molars - For Upper wisdom teeth
Ottavi superiori - Per denti del giudizio superiori
Molares superiores - Para muelas del juicio superiores
Molaires supérieures - Pour dents de sagesse supérieures

Zahnzangen, Englische Form
Extracting Forceps, English Pattern
Pinze per estrazione, Forma Inglese
Pinzas da extracción, Forma Inglesa
Daviers, Forme Anglaise

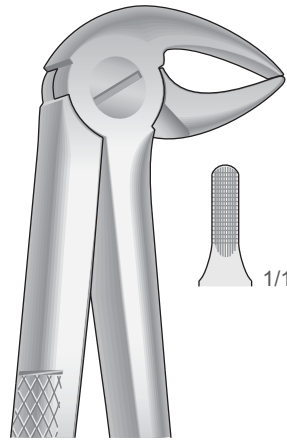

33
Fig. 33

Untere Prämolaren, Schneidezähne und Wurzeln
Lower incisors, premolars and roots
Incisivi, premolari e radici inferiori
Incisivos, premolares y raíces inferiores
Incisives, prémolaires et racines inférieures

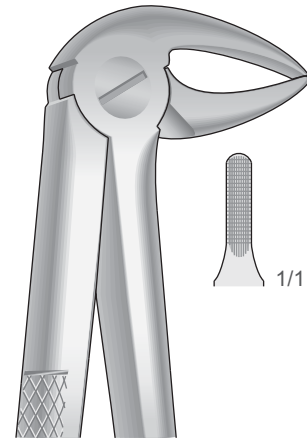

33A
Fig. 33A

Untere Wurzeln, schlankes Maul
Lower roots, Slender jaw
Radici inferiori, morso stretto
Raíces inferiores, boca estrecha
Racines inférieures, avec un bec très fin

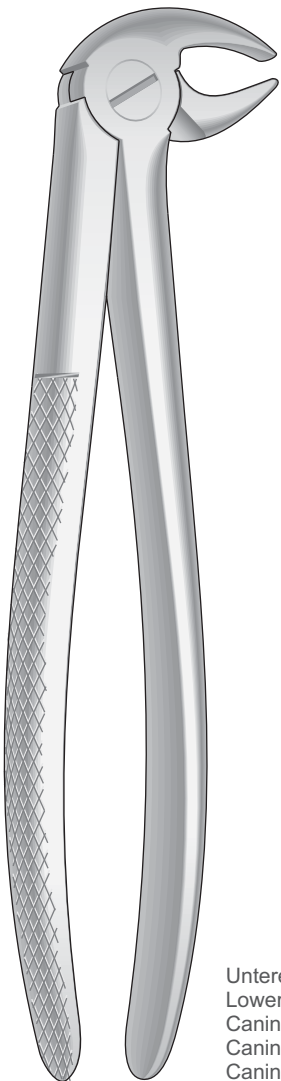

13
Fig. 13

Untere Eckzähne und Prämolaren
Lower cuspids and premolars
Canini e premolari inferiori
Caninos y premolares inferiores
Canines et prémolaires inférieures

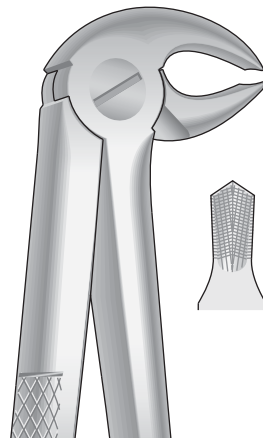

22
Fig. 22

Untere Molaren
Lower molars
Molari inferiori
Molares inferiores
Molaires inférieures

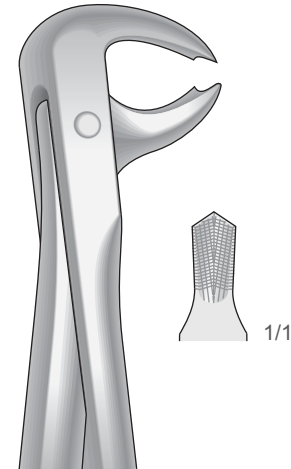

73
Fig. 73

Untere Molaren
Lower molars
Molari inferiori
Molares inferiores
Molaires inférieures



Zahnzangen, Englische Form
Extracting Forceps, English Pattern
Pinze per estrazione, Forma Inglese
Pinzas da extracción, Forma Inglesa
Daviers, Forme Anglaise

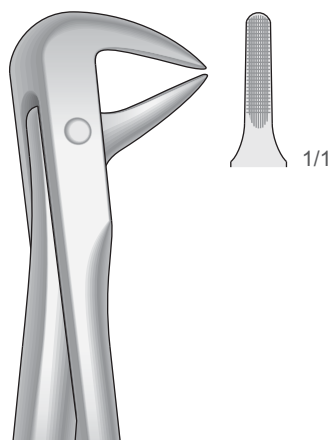

74N
Fig. 74N

Untere Wurzeln, schneide-und Eckzähne
Lower roots, Incisors and bicuspid
Radici, incisivi e canini inferiori
Raíces, incisivos y caninos inferiores
Racines, incisives et canines inférieures

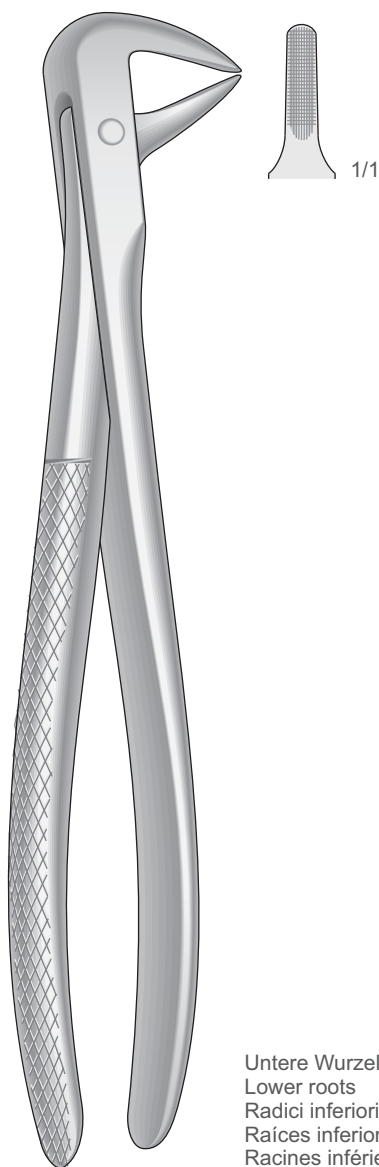

74
Fig. 74

Untere Wurzeln
Lower roots
Radici inferiori
Raíces inferiores
Racines inférieures

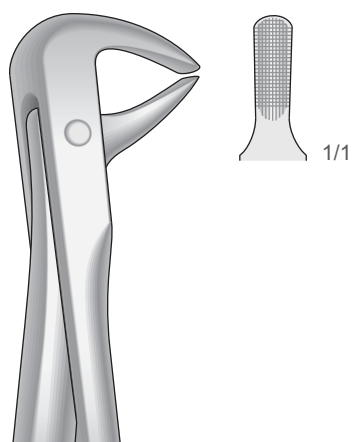

75
Fig. 75

Untere Eckzähne und Prämolaren
Lower Cuspids and bicuspid
Canini e premolari inferiori
Caninos y premolares inferiores
Canines et prémolaires inférieures

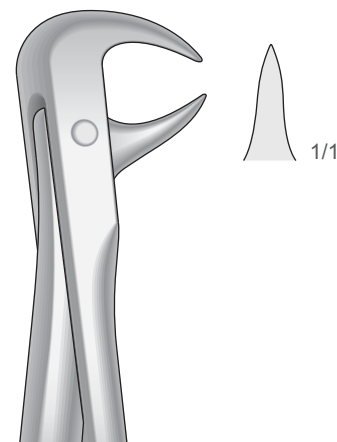

86A
Fig. 86A

Untere Molaren
Lower molars
Molari inferiori
Molares inferiores
Molaires inférieures



Zahnzangen, Englische Form
Extracting Forceps, English Pattern
Pinze per estrazione, Forma Inglese
Pinzas da extracción, Forma Inglesa
Daviers, Forme Anglaise

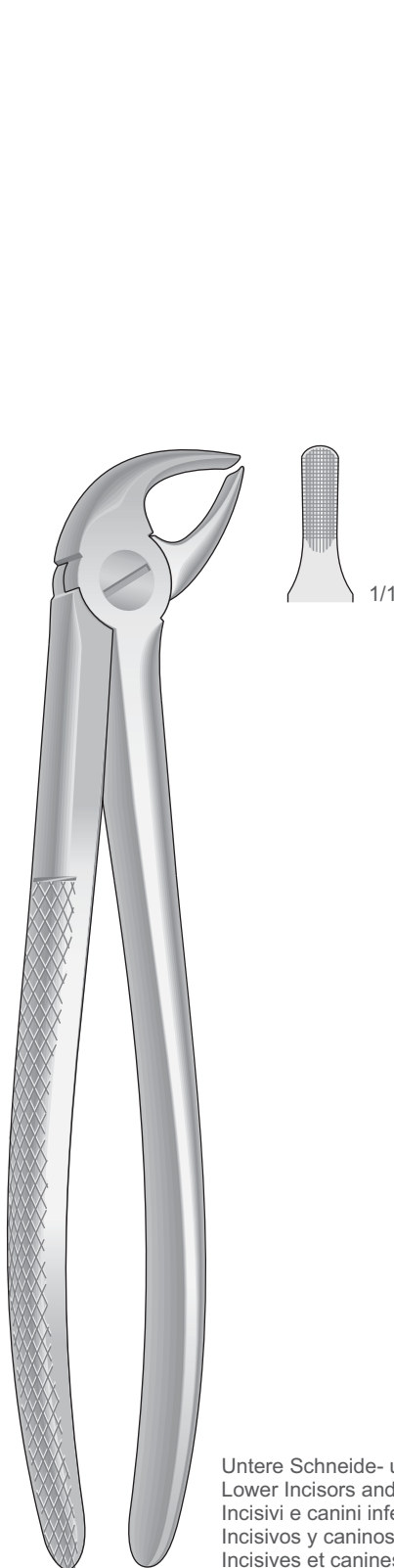

4
Fig. 4

Untere Schneide- und Eckzähne
Lower Incisors and cuspids
Incisivi e canini inferiori
Incisivos y caninos inferiores
Incisives et canines inférieures

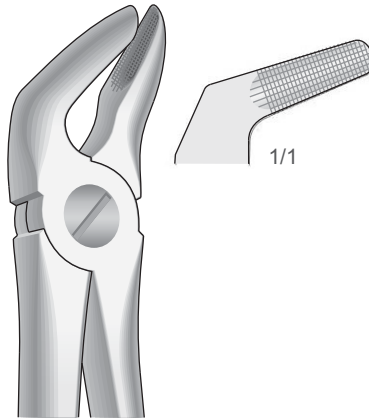

8
Fig. 8

Untere Prämolaren
Lower premolars
Premolari inferiori
Premolares inferiores
Prémolaires inférieures

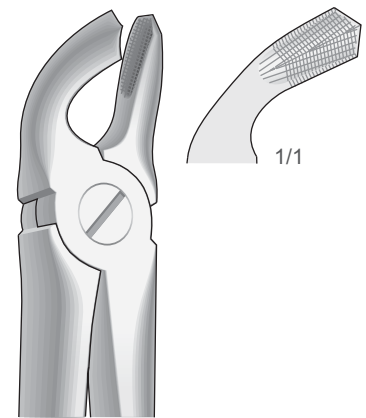

21
Fig. 21

Untere Weisheitszähne und Molaren
Lower wisdom teeth and molars
Denti del giudizio e molari inferiori
Muelas del juicio y Molares inferiores
Dents de sagesse et molaires inférieures

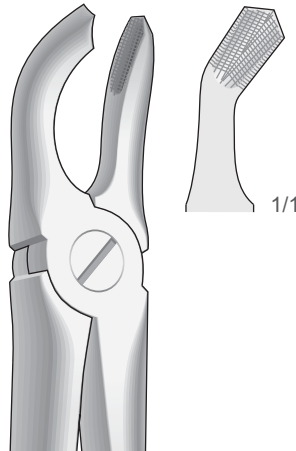

79
Fig. 79

Untere Weisheitszähne
Lower wisdom teeth
Denti del giudizio inferiori
Muelas del juicio inferiores
Dent de sagesse inférieures

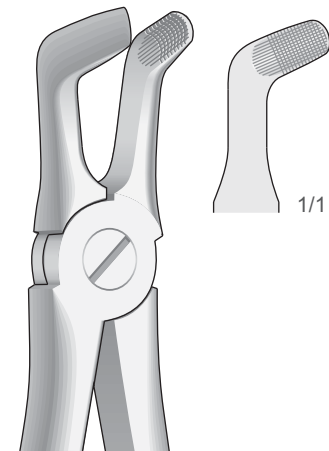

79A
Fig. 79A

Untere Molaren und Weisheitszähne
Lower molars and wisdom teeth
Molari e denti del giudizio inferiori
Molares y muelas del juicio inferiores
Molaires et dent de sagesse inférieures



Zahnzangen, Englische Form
Extracting Forceps, English Pattern
Pinze per estrazione, Forma Inglese
Pinzas da extracción, Forma Inglesa
Daviers, Forme Anglaise

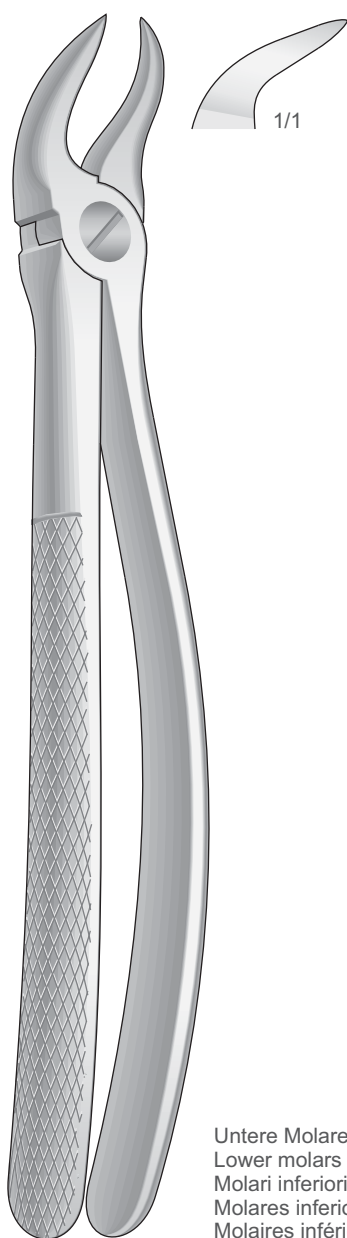

87
Fig. 87

Untere Molaren
Lower molars
Molari inferiori
Molares inferiores
Molaires inférieures

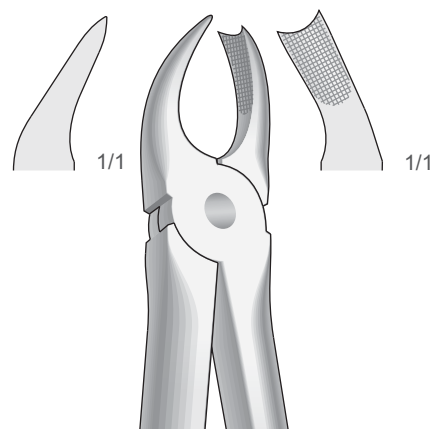

89
Fig. 89

Obere Molaren, rechts
Upper molars, right
Molari superiori, destra
Molares superiores, derechos
Molaires supérieures, droites

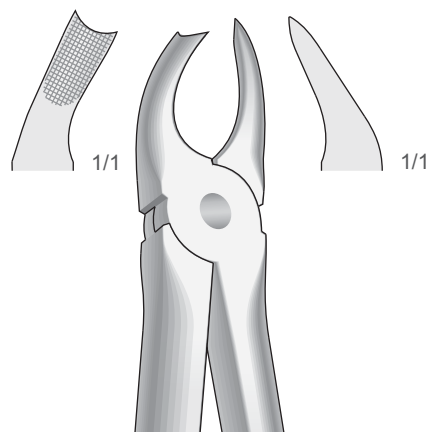

90
Fig. 90

Obere Molaren, links
Upper molars, left
Molari superiori, sinistra
Molares superiores, izquierdos
Molaires supérieures, gauches

Zahnzangen, Englische Form
Extracting Forceps, English Pattern
Pinze per estrazione, Forma Inglese
Pinzas da extracción, Forma Inglesa
Daviers, Forme Anglaise

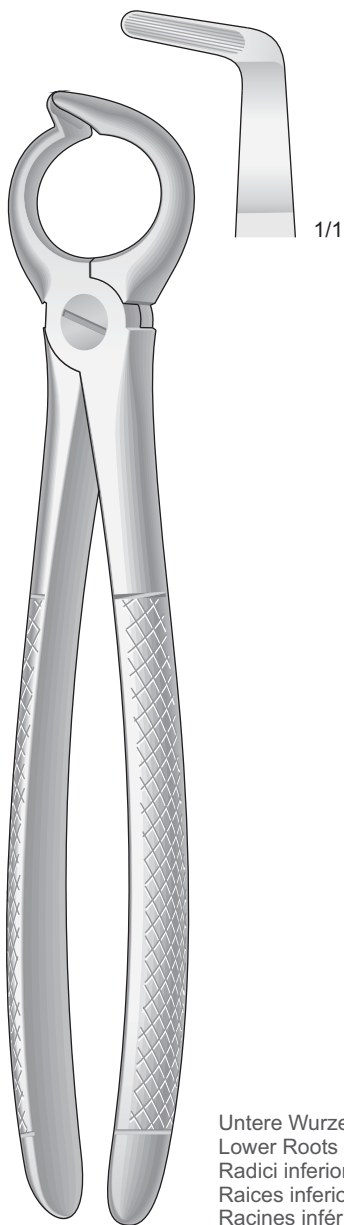

68
Fig. 68

Untere Wurzeln
Lower Roots
Radici inferiori
Raices inferiores
Racines inférieures

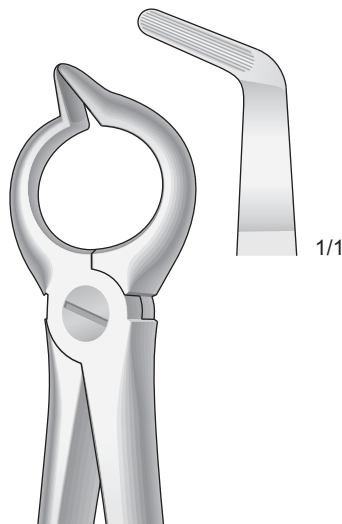

68A
Fig. 68A

Untere Wurzeln
Lower Roots
Radici inferiori
Raices inferiores
Racines inférieures

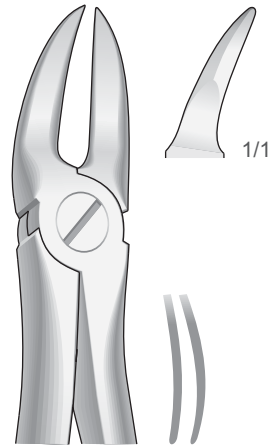

55
Fig. 55

Zum Trennen oberer Molarenwurzeln
For separating upper molar roots
Per radici dei molari superiori, presa in profondità
Para partir raíces de molares superiores, profundo
Pour séparer les racines des molaires supérieures

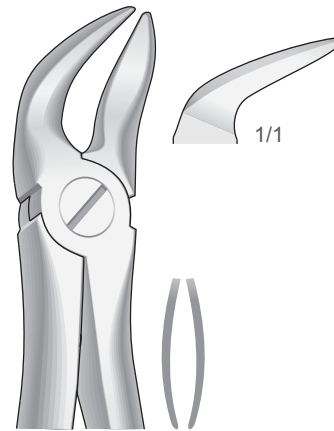

56
Fig. 56

Zum Trennen Unterer Molarenwurzeln
For separating lower molar roots
Per radici dei molari inferiori, presa in profondità
Para partir raíces de molares inferiores, profundo
Pour séparer les racines des molaires inférieures



Zahnzangen, Englische Form
Extracting Forceps, English Pattern
Pinze per estrazione, Forma Inglese
Pinzas da extracción, Forma Inglesa
Daviers, Forme Anglaise

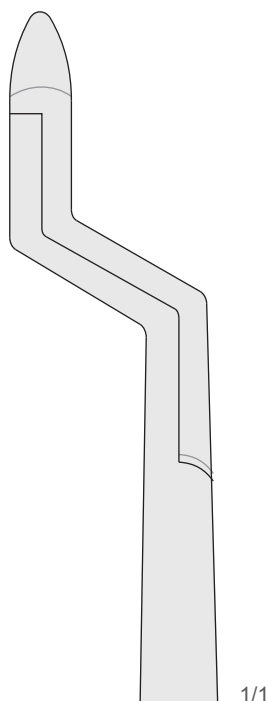
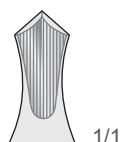
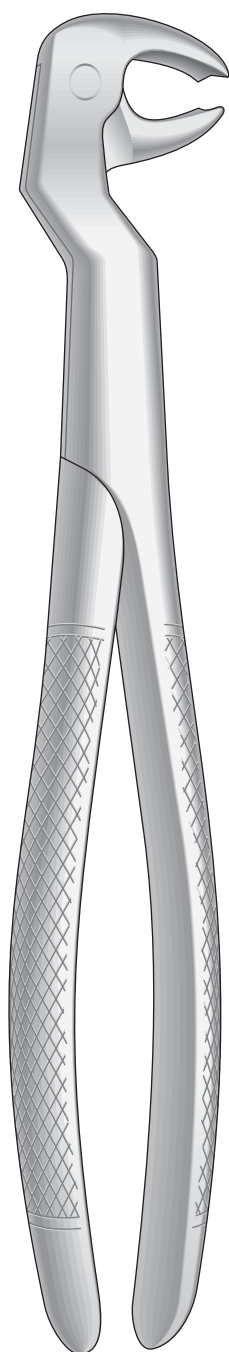

Untere Molaren und Weisheitszähne, rechts
Lower molars and wisdom teeth, right
Molari e denti del giudizio inferiori, a destra
Molares y muelas del juicio inferiores, derecha
Molaires et dent de sagesse inférieures, droites

ROUTURIER
22 1/2 R

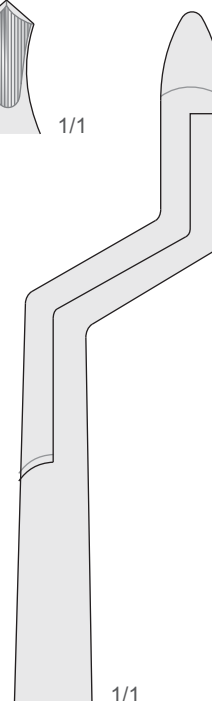
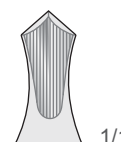
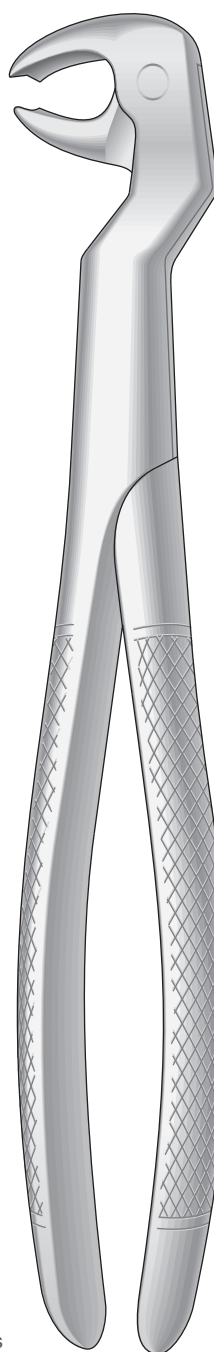

Untere Molaren und Weisheitszähne, links
Lower molars and wisdom teeth, left
Molari e denti del giudizio inferiori, a sinistra
Molares y muelas del juicio inferiores, izquierda
Molaires et dent de sagesse inférieures, gauches

ROUTURIER
22 1/2 L

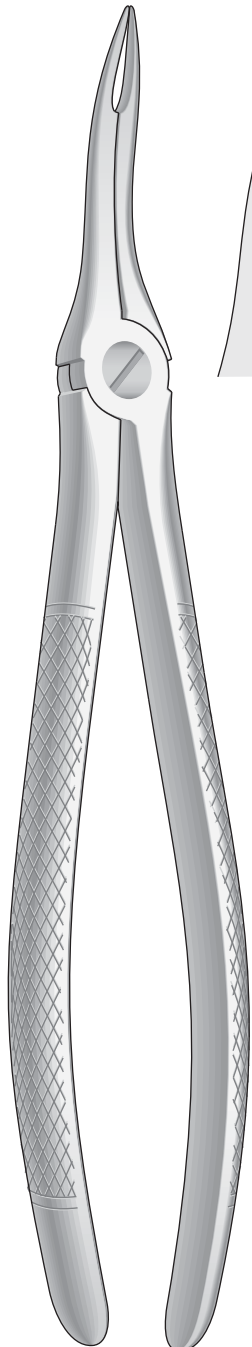

49
Fig. 49

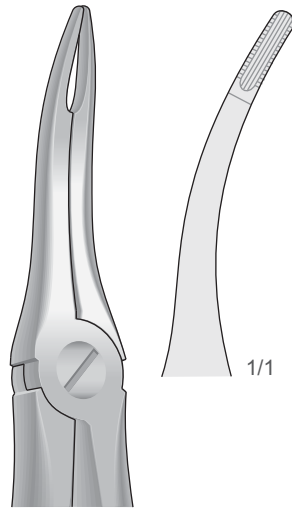
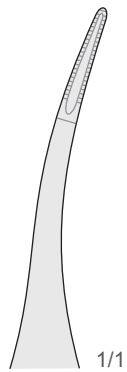

48
Fig. 48 - 44

Obere Wurzeln
Upper roots
Radici superiori
Raíces superiores
Racines supérieures

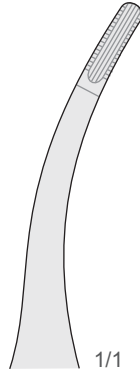

Obere Wurzeln sehr feine
Upper very fine roots
Radici superiori molto sottili
Raíces superiores muy finas
Racines supérieures très fines

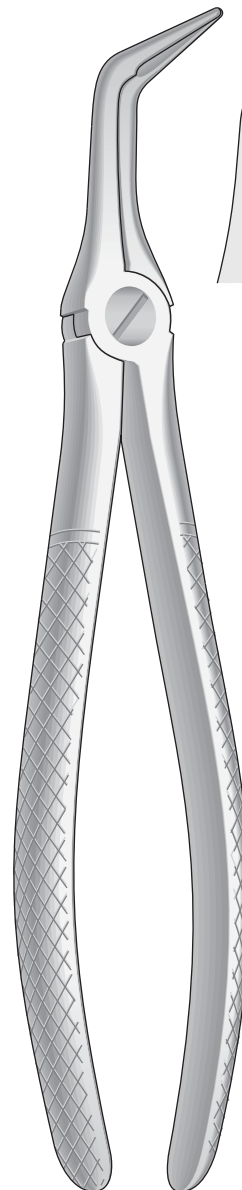

46L
Fig. 46L

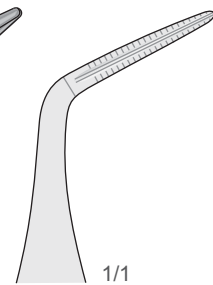

Untere Wurzeln
Lower roots
Radici inferiori
Raíces inferiores
Racines inférieures



Zahnzangen, Paßformgriff
Extracting Forceps, Anatomical Handle
Pinze per estrazione, Manico anatomico
Pinzas da extracción, Mango anatómico
Daviers, Manche anatomique

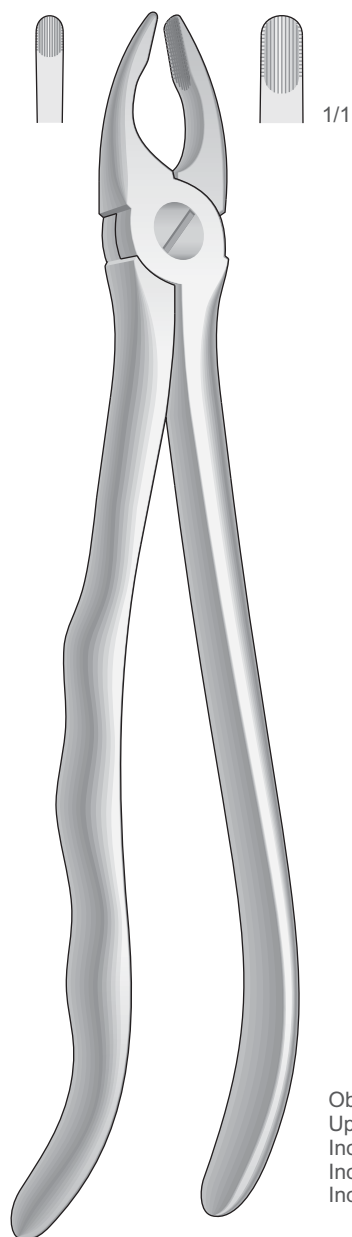

S-3AN
Fig. 3

Obere Schneide- und Eckzähne
Upper incisors and cuspids
Incisivi e canini superiori
Incisivos y caninos superiores
Incisives et canines supérieures

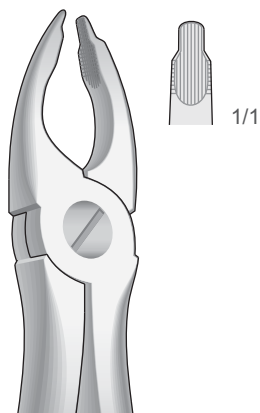

S-34
Fig. 34

Obere Schneide- und Eckzähne
Upper incisors and cuspids
Incisivi e canini superiori
Incisivos y caninos superiores
Incisives et canines supérieures

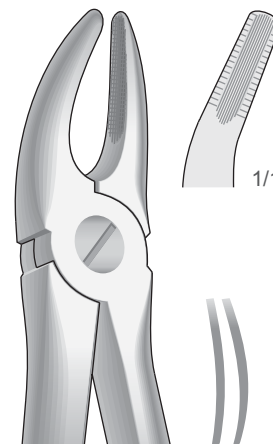

S-7
Fig. 7

Obere Prämolaren
Upper premolars
Premolari superiori
Premolares superiores
Prémolaires supérieures

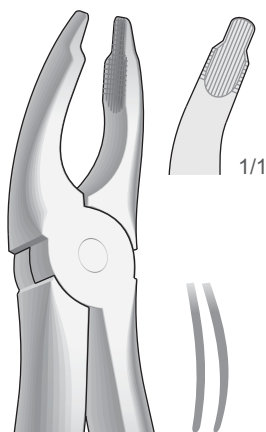

S-35
Fig. 35

Obere Schneidezähne und Prämolaren, tiefgreifend
Upper incisors and bicuspid, deep-gripping
Incisivi e premolari superiori, presa in profondità
Incisivos y premolares superiores, a gran calado
Incisives et prémolaires supérieures, à attaque profonde

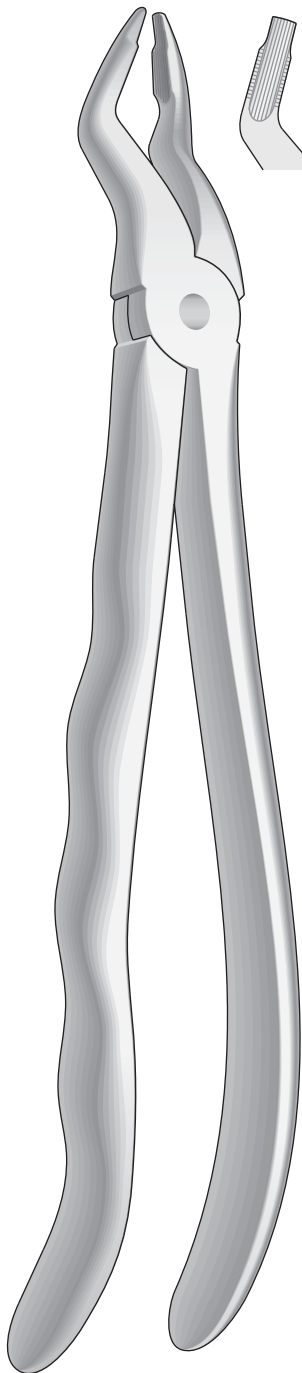

S-31
Fig. 31

Obere Prämolaren
Upper premolars
Premolari superiori
Premolares superiores
Prémolaires supérieures

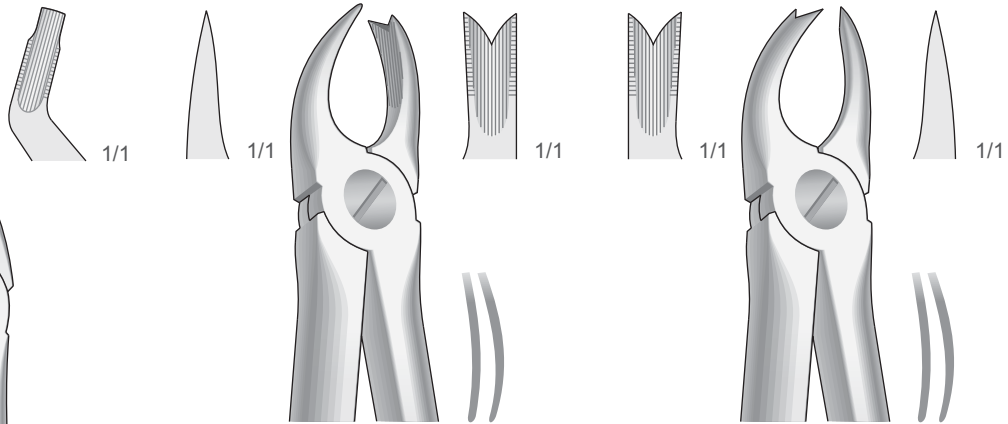

S-66R
Fig. 66R (89)

Obere Molaren, rechts
Upper molars, right
Molari superiori, destra
Molares superiores, derechos
Molaires supérieures, droites

S-66L
Fig. 66L (90)

Obere Molaren, links
Upper molars, left
Molari superiori, sinistra
Molares superiores, izquierdos
Molaires supérieures, gauches



Zahnzangen, Paßformgriff
Extracting Forceps, Anatomical Handle
Pinze per estrazione, Manico anatomico
Pinzas da extracción, Mango anatómico
Daviers, Manche anatomique

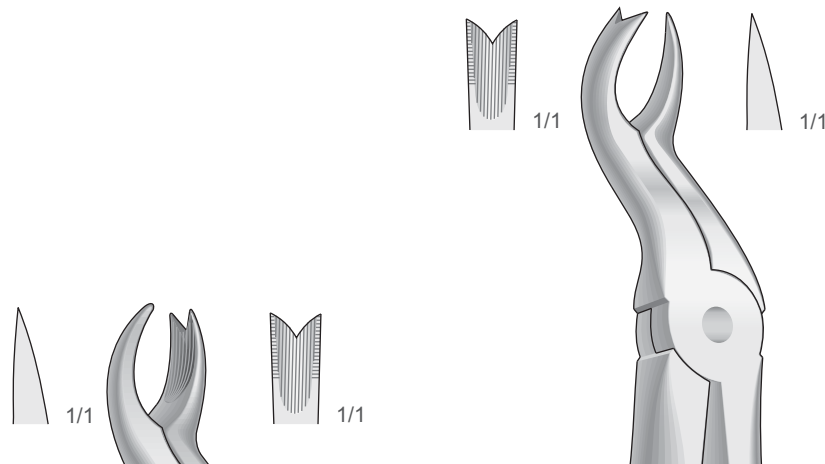

S-67L
Fig. 67L

Obere Molaren, links
Upper molars, left
Molari superiori, sinistra
Molares superiores, izquierdos
Molaires supérieures, gauches

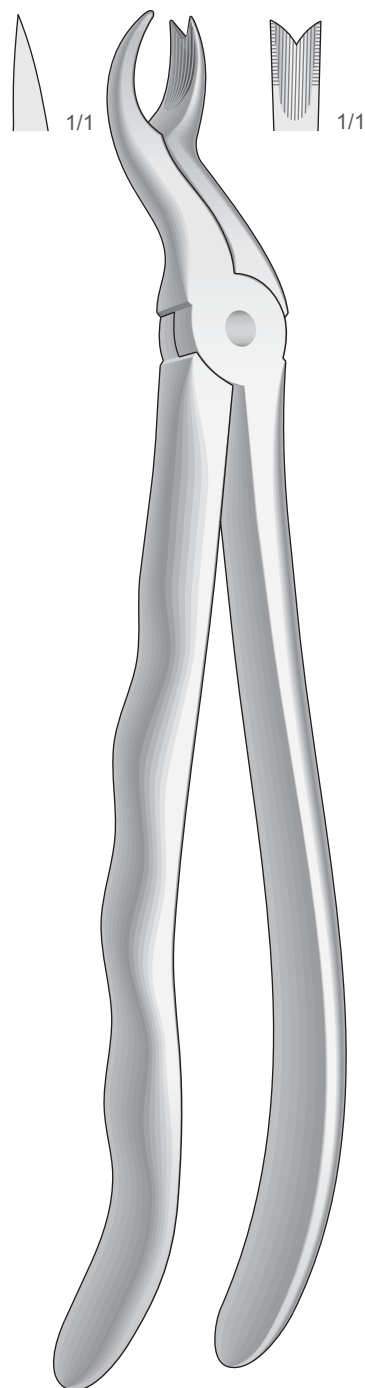

S-67R

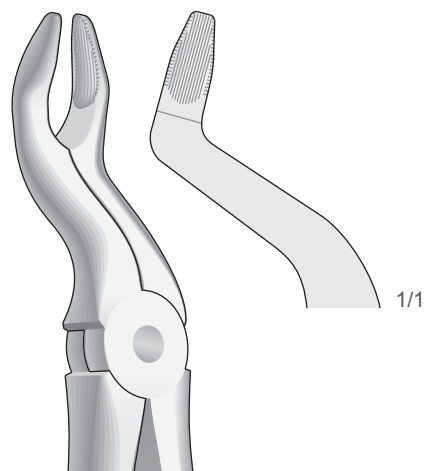

S-67N
Fig. 67N

Obere Molaren
Upper molars
Molari superiori
Molares superiores
Molaires supérieures

Obere Molaren, rechts
Upper molars, right
Molari superiori, destra
Molares superiores, derechos
Molaires supérieures, droites

Zahnzangen, Paßformgriff
Extracting Forceps, Anatomical Handle
Pinze per estrazione, Manico anatomico
Pinzas da extracción, Mango anatómico
Daviers, Manche anatomique

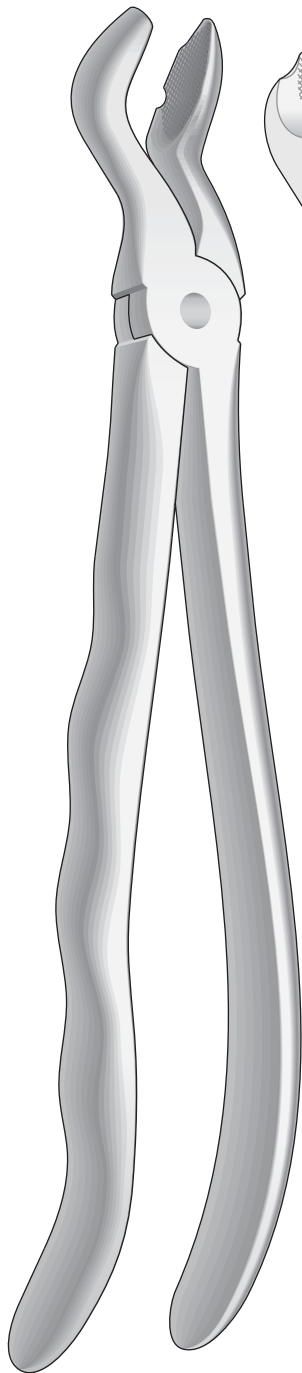

FELSCH
S-80
Fig. 80

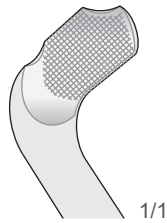

1/1

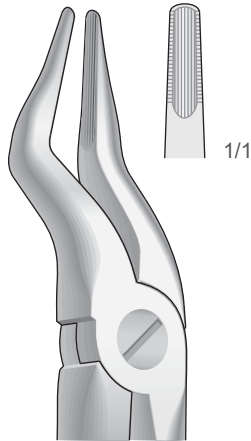

1/1

S-51B
Fig. 51B

Obere Dritte Molaren
Upper molars
Ottavi superiori
Molares superiores
Molaires supérieures

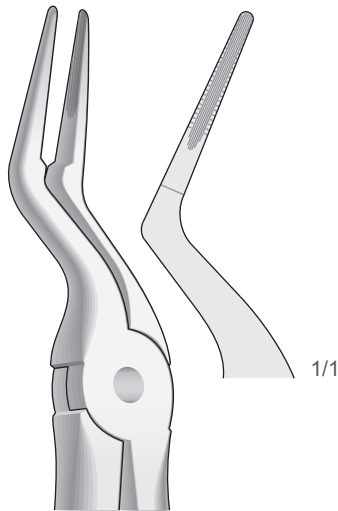

1/1

S-97
Fig. 97

Obere Wurzelplitterzange
Upper Root Fragments
Frammenti e radici superiori
Fragmentos de raíces superiores
Fragments des racines supérieures

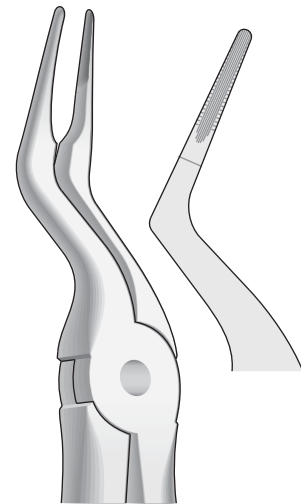

1/1

S-97B
Fig. 97B

Obere Wurzelplitterzange
Upper Root Fragments
Frammenti e radici superiori
Fragmentos de raíces superiores
Fragments des racines supérieures

Für obere Weisheitszähne, mit Fangvorrichtung
For upper wisdom teeth, with retaining device
Denti del giudizio superiori, con dispositivo di presa
Muelas del juicio superiores, con dispositivo de retencion
Pour dents de sagesse supérieures, mors conçus pour recueillir la dent



Zahnzangen, Paßformgriff
Extracting Forceps, Anatomical Handle
Pinze per estrazione, Manico anatomico
Pinzas da extracción, Mango anatómico
Daviers, Manche anatomique

Obere Wurzeln sehr feine
Upper very fine roots
Radici superiori molto sottili
Raíces superiores muy finas
Racines supérieures très fines

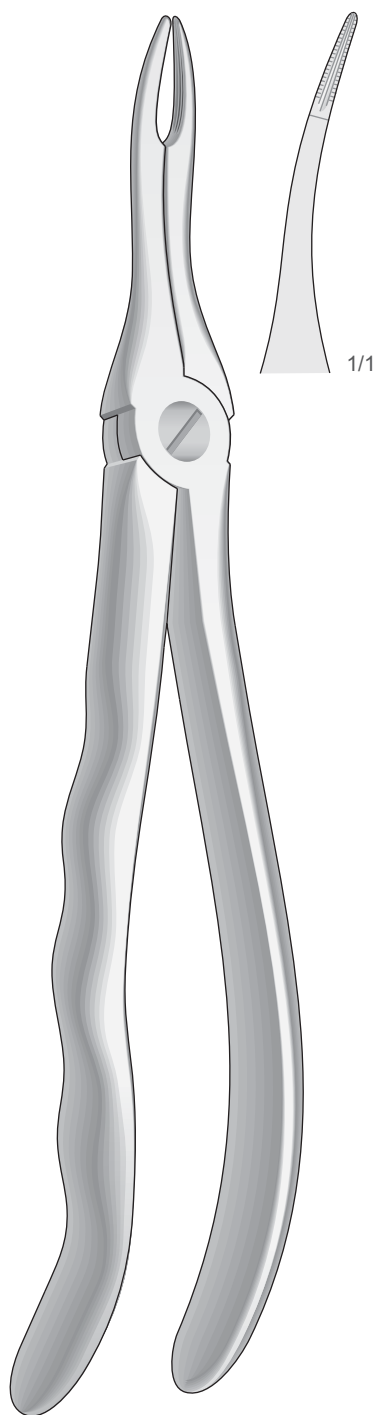

S-49
Fig. 49

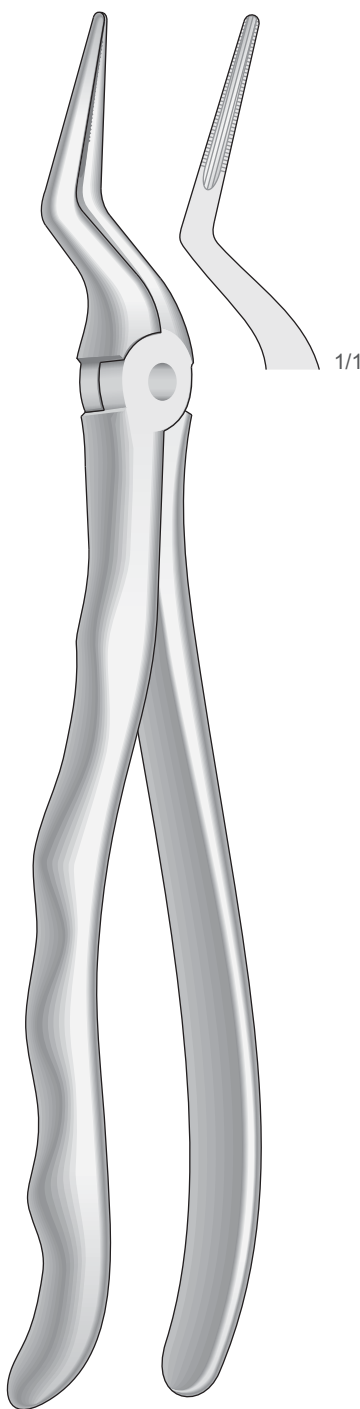

S-51LX
Fig. 51LX

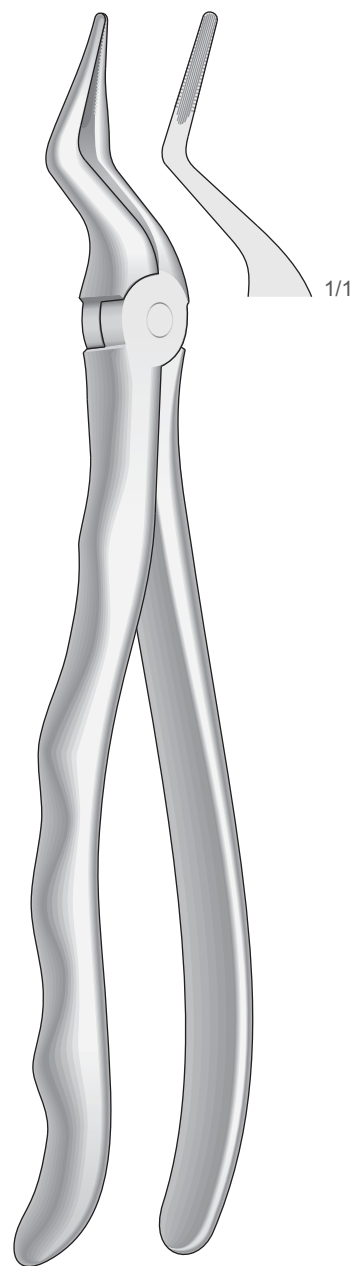

S-351S
Fig. 351S

Zahnzangen, Paßformgriff
Extracting Forceps, Anatomical Handle
Pinze per estrazione, Manico anatomico
Pinzas da extracción, Mango anatómico
Daviers, Manche anatomique

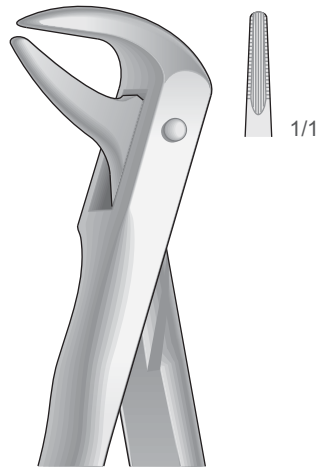

I-74N
Fig. 74N

Untere Wurzeln Schneide- und Eckzähne
Lower roots, incisors and cuspids
Radici, incisivi e canini inferiori
Raíces, incisivos y caninos inferiores
Racines, incisives et canines inférieures

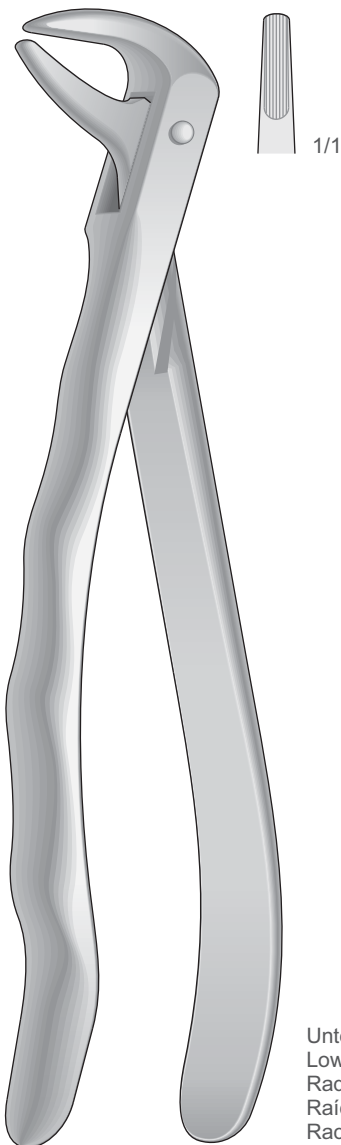

I-74
Fig. 74

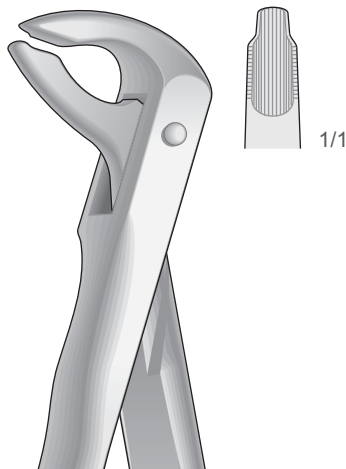

I-36
Fig. 36

Untere Wurzeln Schneide- und Eckzähne
Lower roots, incisors and cuspids
Radici, incisivi e canini inferiori
Raíces, incisivos y caninos inferiores
Racines, incisives et canines inférieures

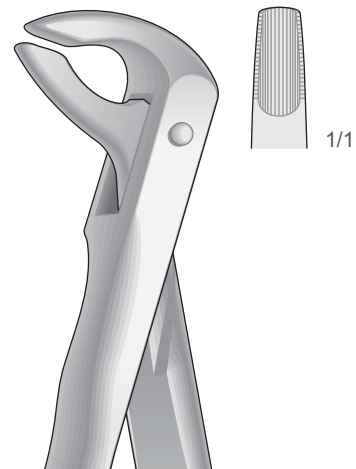

I-36N
Fig. 36N

Untere Wurzeln Schneide- und Eckzähne
Lower roots, incisors and cuspids
Radici, incisivi e canini inferiori
Raíces, incisivos y caninos inferiores
Racines, incisives et canines inférieures

Untere Wurzeln Schneide- und Eckzähne
Lower roots, incisors and cuspids
Radici, incisivi e canini inferiori
Raíces, incisivos y caninos inferiores
Racines, incisives et canines inférieures



Zahnzangen, Paßformgriff
Extracting Forceps, Anatomical Handle
Pinze per estrazione, Manico anatomico
Pinzas da extracción, Mango anatómico
Daviers, Manche anatomique

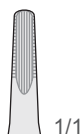

I-59
Fig. 59

Untere Wurzelplitterzange
Lower Root Fragments
Frammenti e radici inferiori
Fragmentos de raíces inferiores
Fragments des racines inférieures

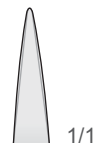

I-86C
Fig. 86C

Untere Molaren mit kariösen oder abgebrochenen Kronen
Lower molars with carious or broken caps
Molari inferiori con corone cariate o spezzate
Molares inferiores con coronas rotas o cariadas
Molaires inférieures avec couronnes cariées ou cassées

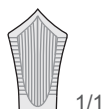
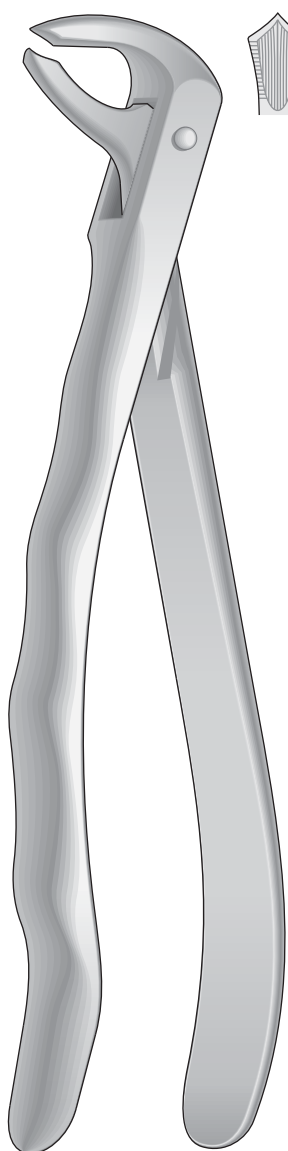

I-73
Fig. 73

Untere Molaren
Lower molars
Molari inferiori
Molares inferiores
Molaires inférieures

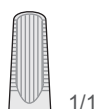
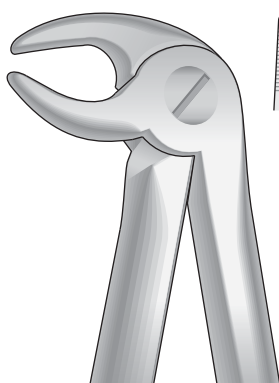

I-13
Fig. 13

Untere Prämolaren und Eckzähne
Lower premolars and cuspids
Canini e premolari inferiori
Caninos y premolares inferiores
Canines et prémolaires inférieures

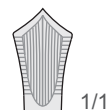

I-22
Fig. 22

Untere Molaren
Lower molars
Molari inferiori
Molares inferiores
Molaires inférieures

Untere Weisheitszähne
Lower wisdom teeth
Denti del giudizio inferiori
Muelas del juicio inferiores
Dent de sagesse inférieures

Untere Prämolaren
Lower premolars
Premolari inferiori
Premolares inferiores
Prémolaires inférieures

Untere Molaren
Lower Molars
Molari inferiori
Molares inferiores
Molaires inférieures

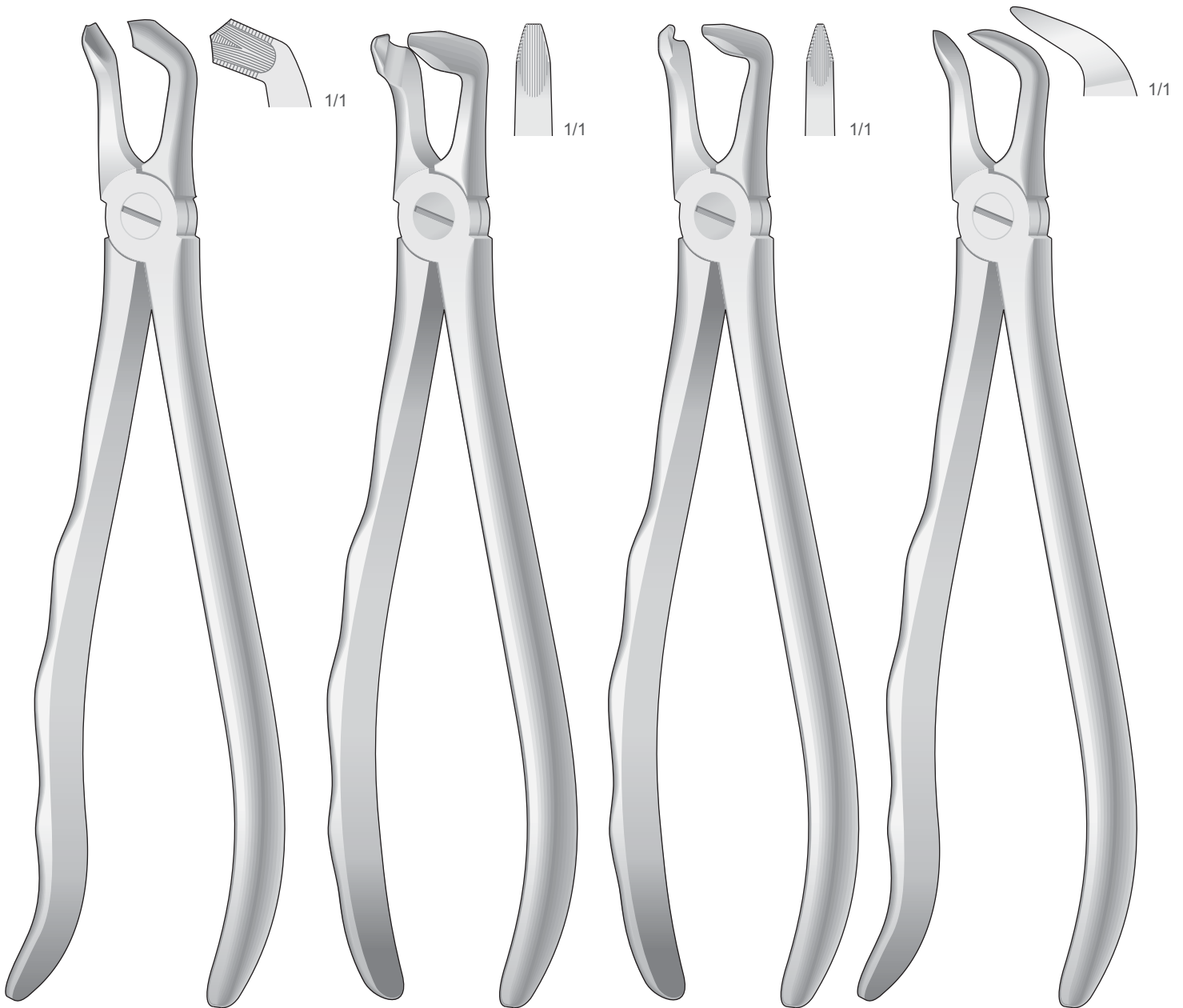

I-79
Fig. 79

I-79N
Fig. 79N

I-46N
Fig. 46N

I-87
Fig. 87



Zahnzangen, Paßformgriff
Extracting Forceps, Anatomical Handle
Pinze per estrazione, Manico anatomico
Pinzas da extracción, Mango anatómico
Daviers, Manche anatomique

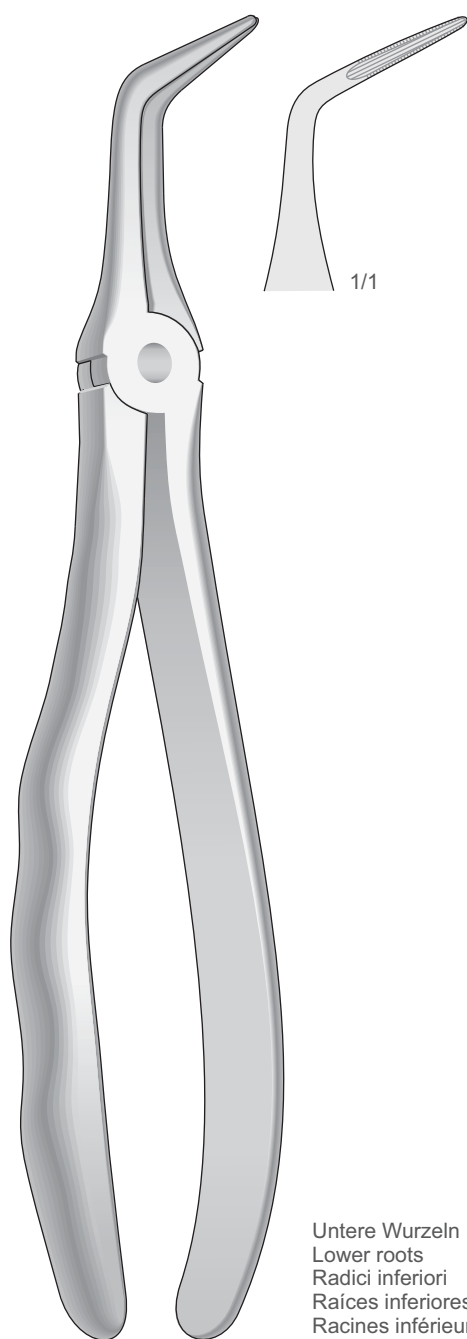

Untere Wurzeln
Lower roots
Radici inferiori
Raíces inferiores
Racines inférieures

I-46LX
Fig. 46LX

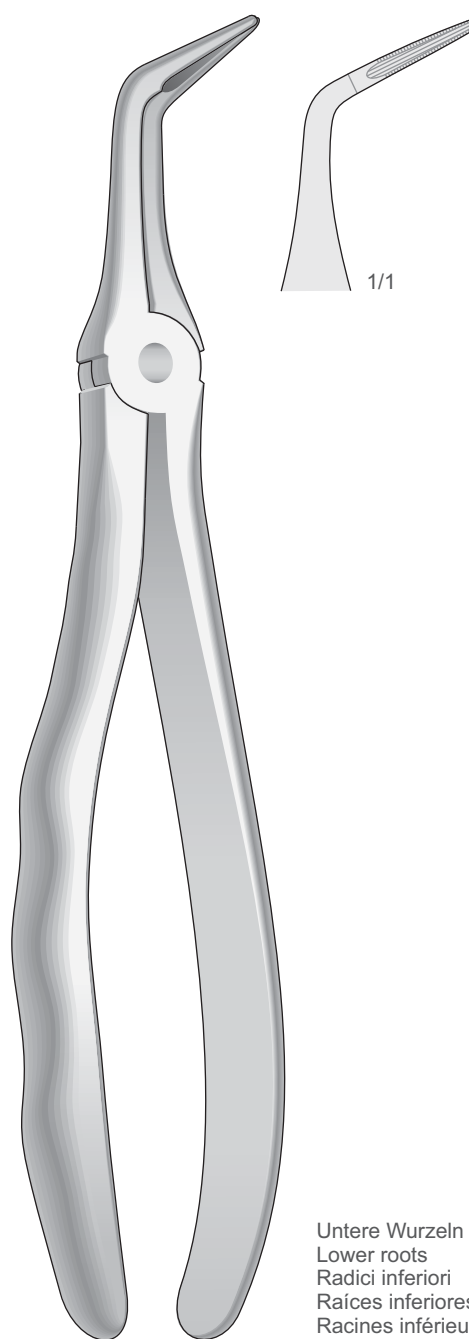

Untere Wurzeln
Lower roots
Radici inferiori
Raíces inferiores
Racines inférieures

I-46L
Fig. 46L

Untere Molaren und Weisheitszähne
Lower molars and wisdom teeth
Molari e denti del giudizio inferiori
Molares y muelas del juicio inferiores
Molaires et dent de sagesse inférieures

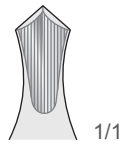
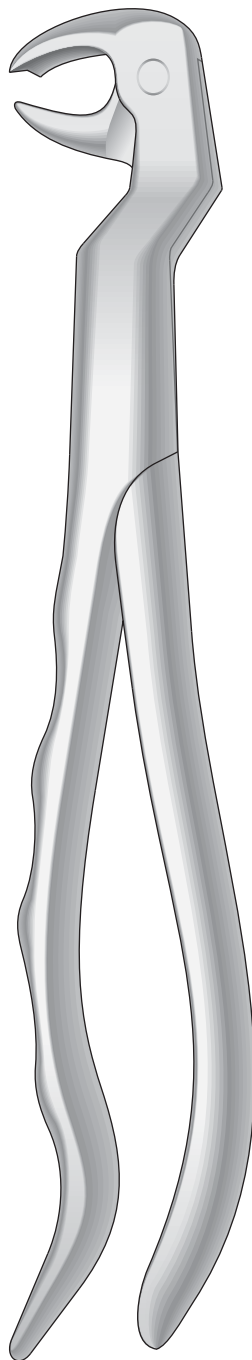

Links
Left
Sinistra
Izquierdos
Gauches

I-22 1/2 L

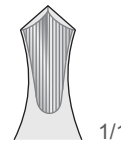
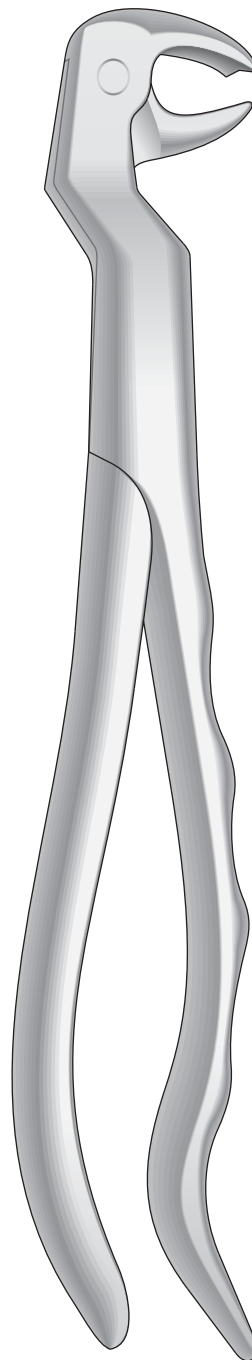

Rechts
Right
Destra
Derechos
Droites

I-22 1/2 R



Zahnzangen, Paßformgriff
Extracting Forceps, Anatomical Handle
Pinze per estrazione, Manico anatomico
Pinzas da extracción, Mango anatómico
Daviers, Manche anatomique

Untere Wurzeln sehr feine
Lower very fine roots
Radici inferiori molto sottili
Raíces inferiores muy finas
Racines inférieures très fines

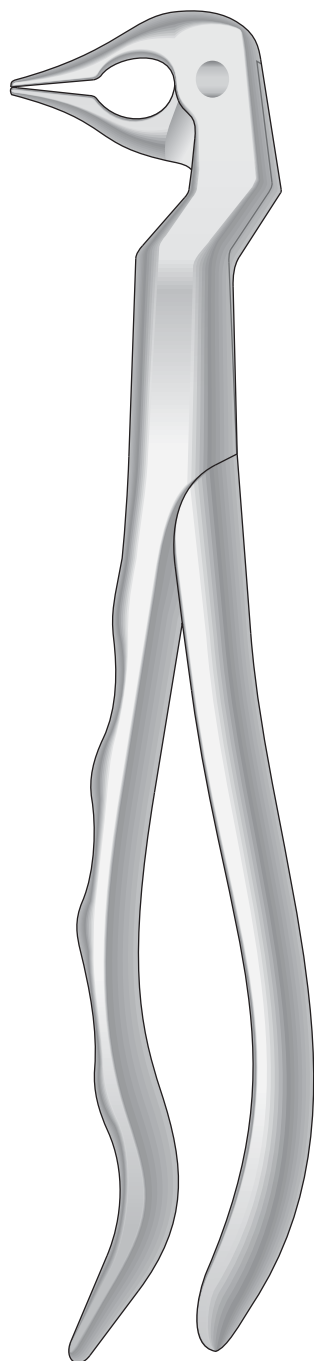

I-133 L
Fig.133

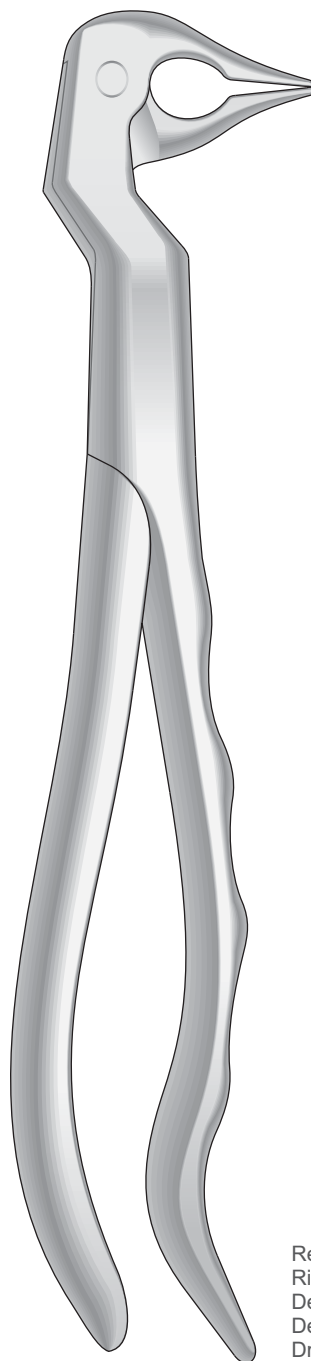

I-133 R
Fig.133

Links
Left
Sinistra
Izquierdos
Gauches

Rechts
Right
Destra
Derechos
Droites

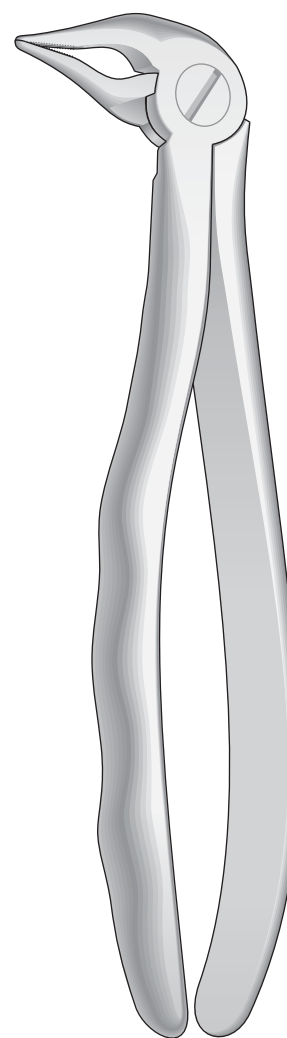

I-333S
Fig.333S

Zahnzangen, Amerikanische Form
Extracting Forceps, American Pattern
Pinze per estrazione, Forma Americana
Pinzas da extracción, Forma Americana
Daviers, Forme Américaine

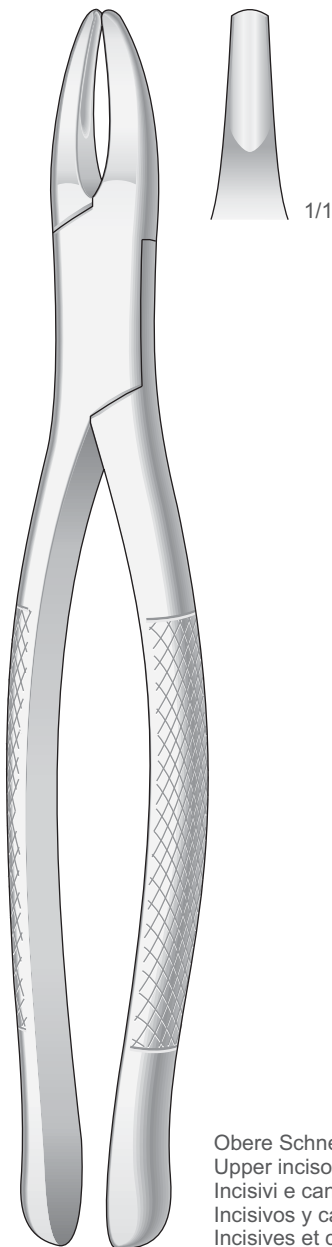

AM-1
Fig. 1

Obere Schneide- und Eckzähne
Upper incisors and cuspids
Incisivi e canini superiori
Incisivos y caninos superiores
Incisives et canines supérieures

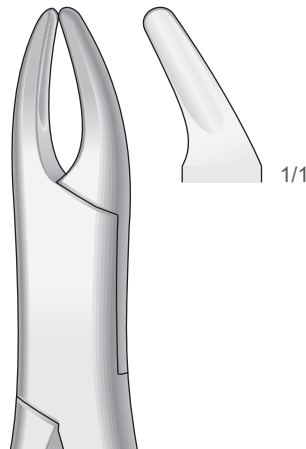

CRYER
AM-150
Fig. 150

Obere Prämolaren, Schneidezähne, Wurzeln
Upper Bicuspid, incisors and roots
Premolari, incisivi e radici superiori
Premolares, incisivos y raíces superiores
Prémolaires, incisives et racines supérieures

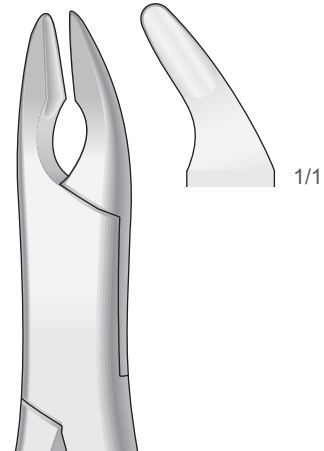

CRYER
AM-150A
Fig. 150A

Obere Prämolaren, Schneidezähne, Wurzeln
Upper Bicuspid, incisors and roots
Premolari, incisivi e radici superiori
Premolares, incisivos y raíces superiores
Prémolaires, incisives et racines supérieures

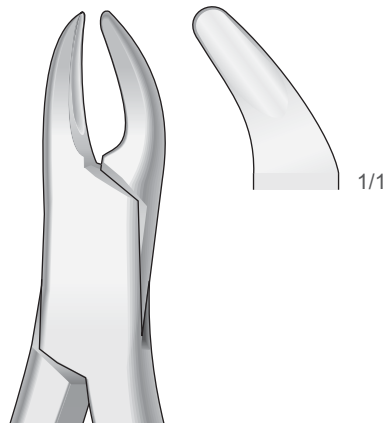

AM-62
Fig. 62

Schneidezähne, Prämolaren, Milchzähne
Incisors, premolars, deciduous teeth
Incisivi, premolari, denti da latte
Incisivos, premolares, dientes de leche
Incisives, prémolaires, dents de lait



Zahnzangen, Amerikanische Form
Extracting Forceps, American Pattern
Pinze per estrazione, Forma Americana
Pinzas da extracción, Forma Americana
Daviers, Forme Américaine

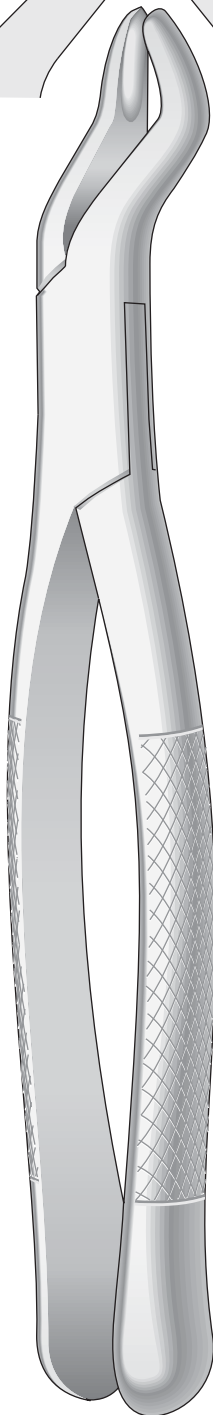
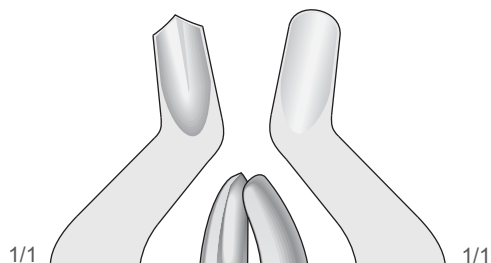

AM-53R
Fig. 53R

Obere Molaren, Rechts
Upper Molars, Right
Molari superiori, Destra
Molares superiores, Derechos
Molaires supérieures, Droites

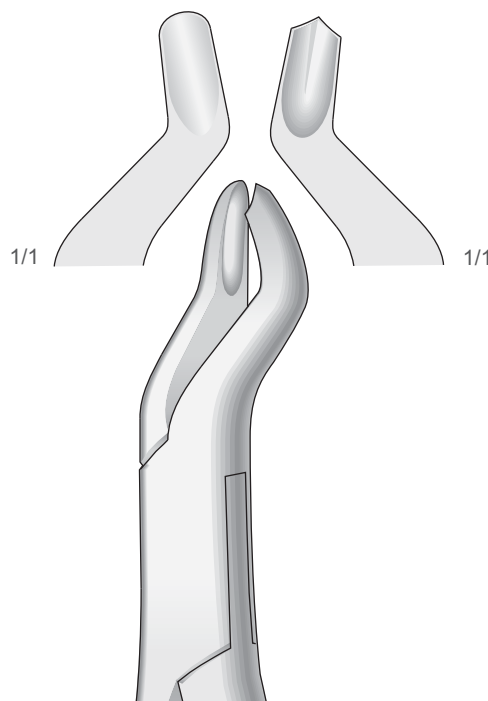

AM-53L
Fig. 53L

Obere Molaren, Links
Upper Molars, Left
Molari superiori, Sinistra
Molares superiores, Izquierdos
Molaires supérieures, Gauches

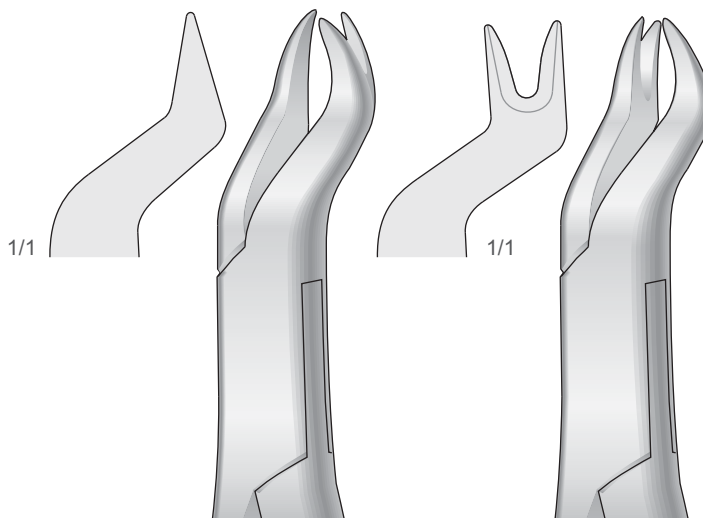

NEVIUS
AM-88R
Fig. 88R

Obere Molaren, Rechts
Upper Molars, Right
Molari superiori, Destra
Molares superiores, Derechos
Molaires supérieures, Droites

NEVIUS
AM-88L
Fig. 88L

Obere Molaren, Links
Upper Molars, Left
Molari superiori, Sinistra
Molares superiores, Izquierdos
Molaires supérieures, Gauches

Zahnzangen, Amerikanische Form
Extracting Forceps, American Pattern
Pinze per estrazione, Forma Americana
Pinzas da extracción, Forma Americana
Daviers, Forme Américaine

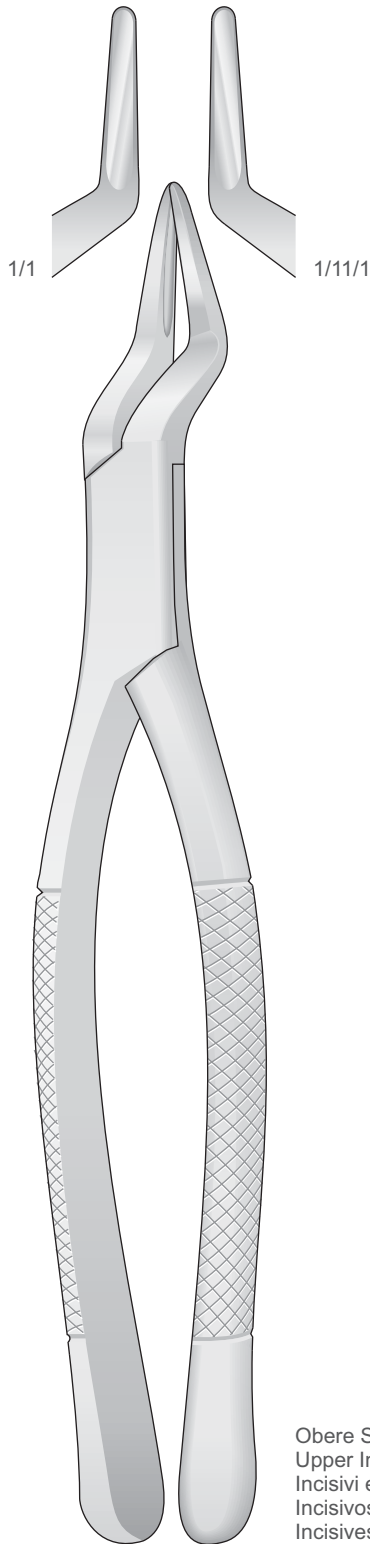

AM-65
Fig.65

Obere Schneidezähne und Wurzeln
Upper Incisors and Roots
Incisivi e radici superiori
Incisivos y raices superiores
Incisives et racines supérieures

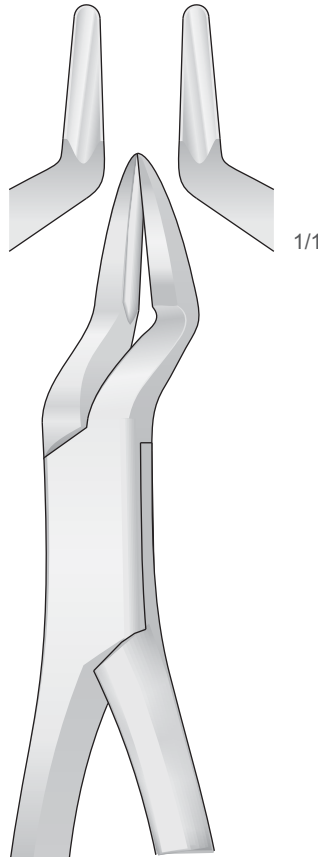

PARMLY
AM-32A
Fig. 32A

Obere Wurzeln und Prämolaren
Upper Roots and Premolars
Radici e premolari superiori
Raíces y premolares superiores
Racines et prémolaires supérieures

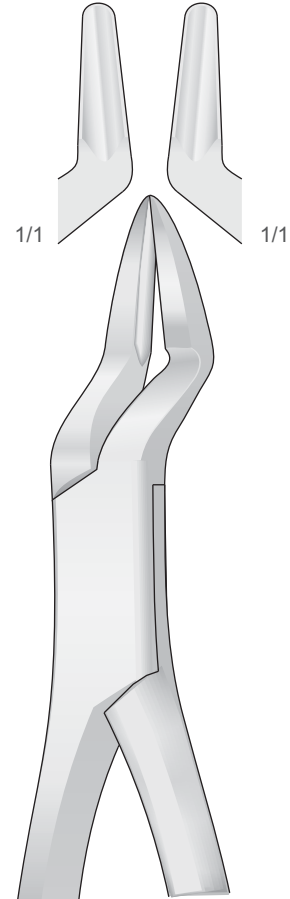

PARMLY
AM-32
Fig. 32

Obere Prämolaren und Molaren
Upper Premolars and Molars
Premolari e molari superiori
Premolares y Molares superiores
Prémolaires et Molaires supérieures



Zahnzangen, Amerikanische Form
Extracting Forceps, American Pattern
Pinze per estrazione, Forma Americana
Pinzas da extracción, Forma Americana
Daviers, Forme Américaine

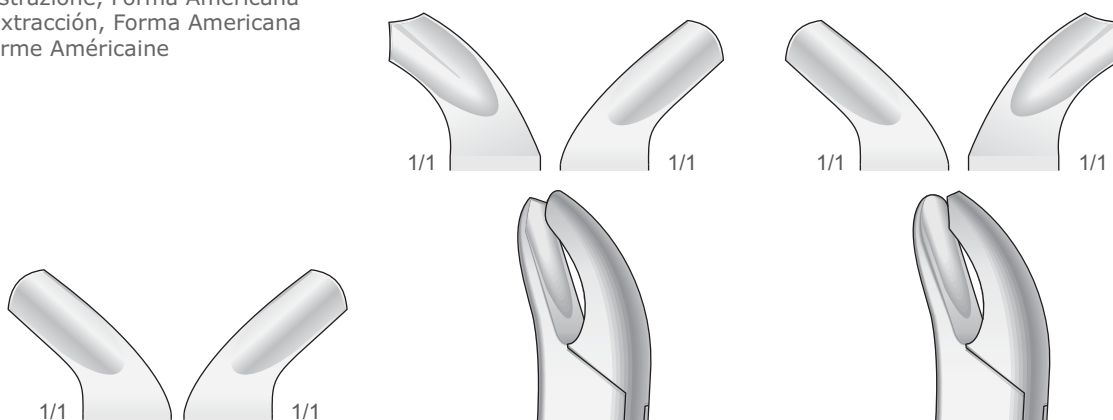

HARRIS
AM-18R
Fig. 18R

Obere Molaren, Rechts
Upper Molars, Right
Molari superiori, Destra
Molares superiores, Derechos
Molaires supérieures, Droites

HARRIS
AM-18L
Fig. 18L

Obere Molaren, Links
Upper Molars, Left
Molari superiori, Sinistra
Molares superiores, Isquierdos
Molaires supérieures, Gauches

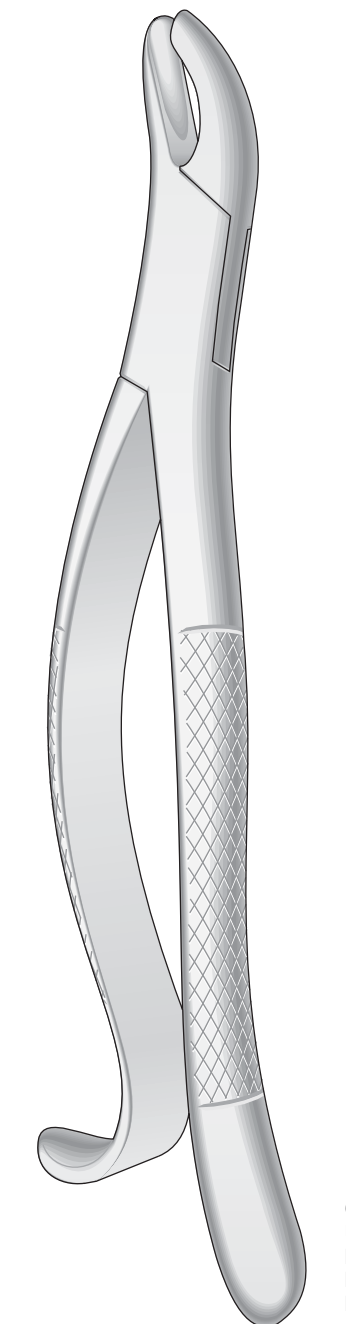

AM-24
Fig. 24

Obere Molaren
Upper Molars
Molari superiori
Molares superiores
Molaires supérieures

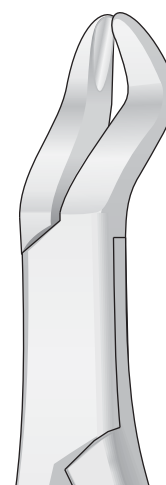
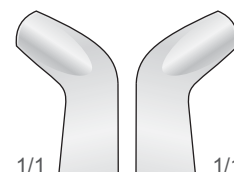

AM-210
Fig. 210

Obere Molaren
Upper Molars
Molari superiori
Molares superiores
Molaires supérieures

Zahnzangen, Amerikanische Form
Extracting Forceps, American Pattern
Pinze per estrazione, Forma Americana
Pinzas da extracción, Forma Americana
Daviers, Forme Américaine

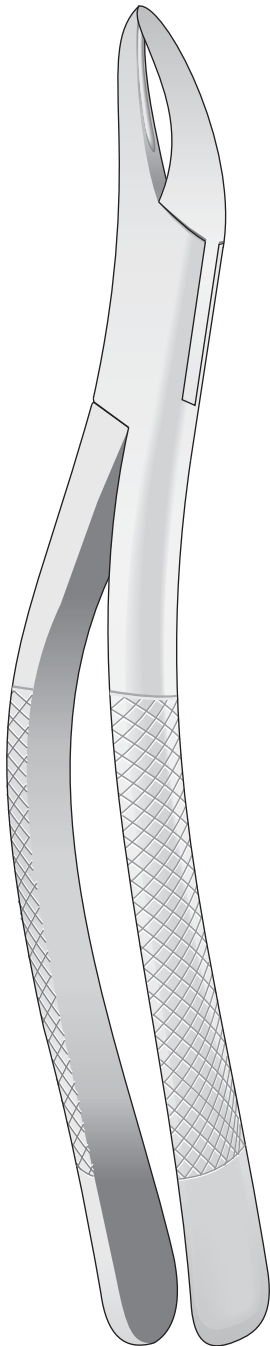
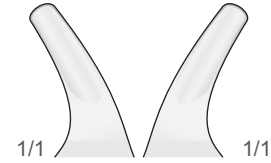
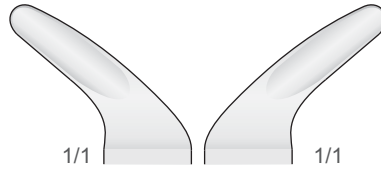
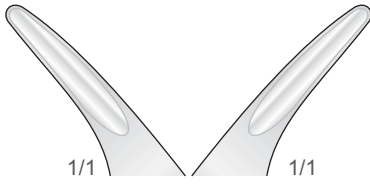

Obere und Untere
Upper and lower
Superiori e inferiori
Superiores y inferiores
Supérieures et inférieures

Wurzeln
Roots
Radici
Raíces
Racines

TOMES
AM-69
Fig.69

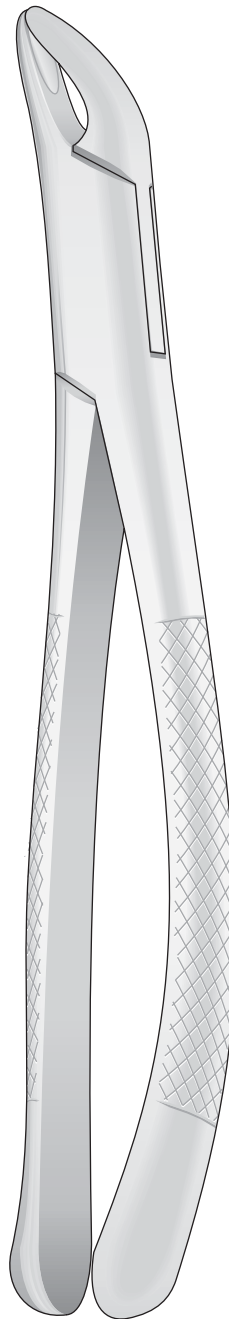

Untere
Lower
Inferiori
Inférieures
Inférieures

Schneidezähne, Prämolaren, Wurzeln
Incisors, Premolars, Roots
Incisivi, premolari, radici
Incisivos, premolares, raíces
Incisives, prémolaires, racines

CRYER
AM-151
Fig.151

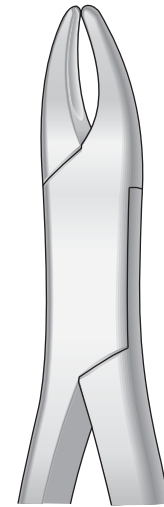

HULL
AM-101
Fig. 101

Für Eckzähne und Prämolaren,
Universalzange und Kinderzange
For canines and Premolars,
Universal and Tooth forceps for children
Canini e premolari,
universale e per bambini
Caninos y premolares,
universal y para niños
Canines et prémolaires,
universel et pour enfants



Zahnzangen, Amerikanische Form
Extracting Forceps, American Pattern
Pinze per estrazione, Forma Americana
Pinzas da extracción, Forma Americana
Daviers, Forme Américaine

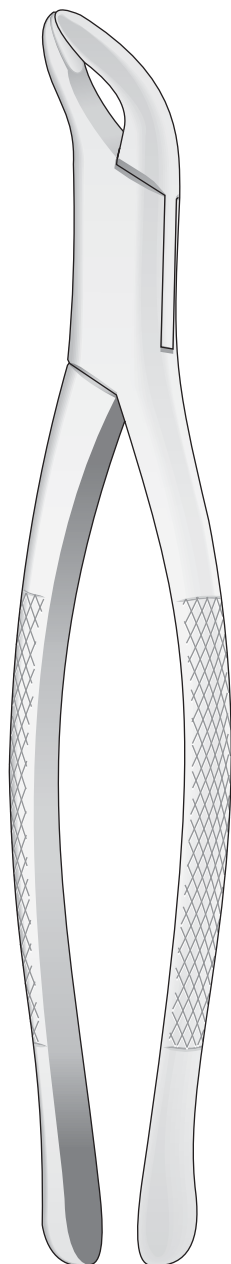
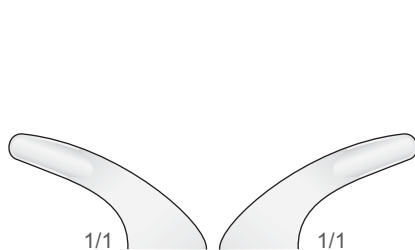

AM-203
Fig. 203

Untere Schneidezähne, Prämolaren, Wurzeln
Lower Incisors, Premolars, Roots
Incisivi, premolari, radici inferiori
Incisivos, premolares, raíces inferiores
Incisives, prémolaires, racines inférieures

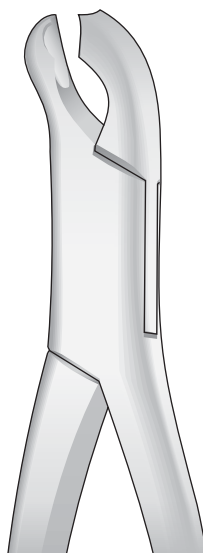
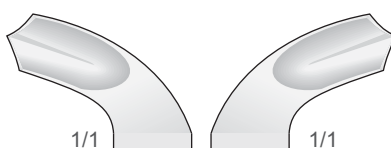

AM-17
Fig. 17

Untere Molaren
Lower Molars
Molari inferiori
Molares inferiores
Molaires inférieures

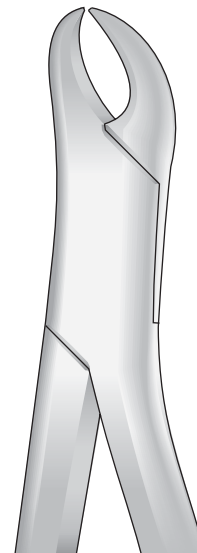

AM-23
Fig. 23

Untere Molaren
Lower Molars
Molari inferiori
Molares inferiores
Molaires inférieures

Zahnzangen, Amerikanische Form
Extracting Forceps, American Pattern
Pinze per estrazione, Forma Americana
Pinzas da extracción, Forma Americana
Daviers, Forme Américaine

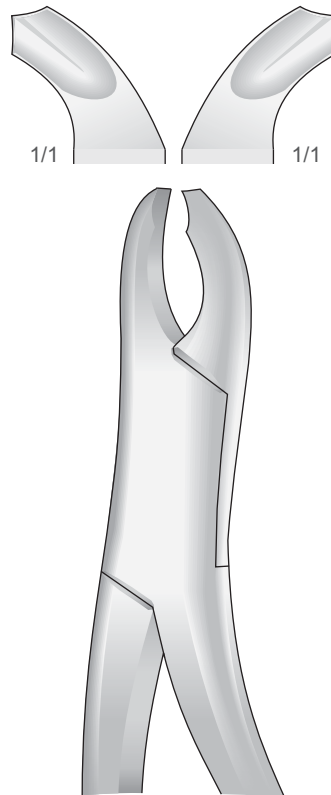
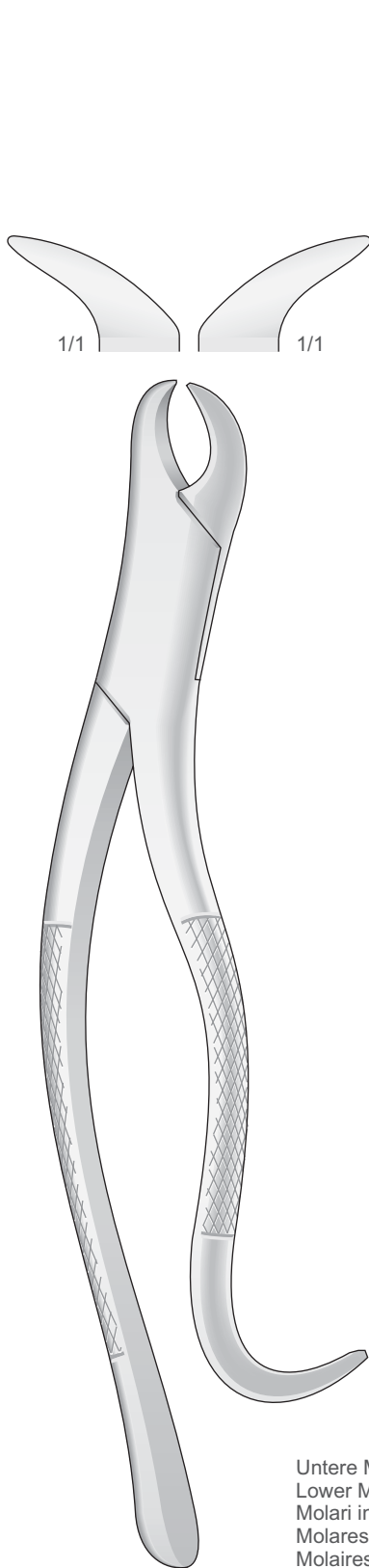

HARRIS
AM-15
Fig. 15

Untere Molaren
Lower Molars
Molari inferiori
Molares inferiores
Molaires inférieures

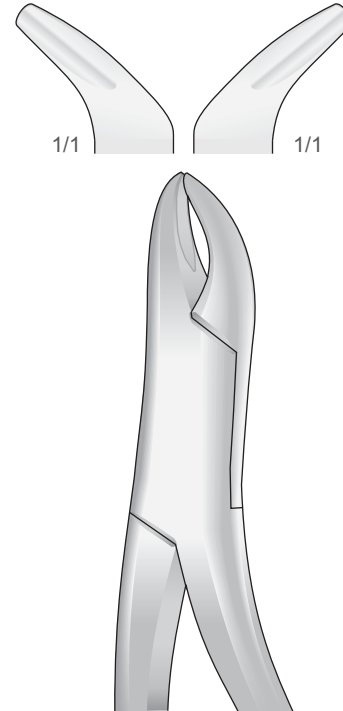

AM-103
Fig. 103

Untere Schneidezähne, Prämolaren, Wurzeln
Lower Incisors, Premolars, Roots
Incisivi, premolari, radici inferiori
Incisivos, premolares, raices inferiores
Incisives, prémolaires, racines inférieures

AM-16
Fig. 16

Untere Molaren
Lower Molars
Molari inferiori
Molares inferiores
Molaires inférieures



Zahnzangen, Amerikanische Form
Extracting Forceps, American Pattern
Pinze per estrazione, Forma Americana
Pinzas da extracción, Forma Americana
Daviers, Forme Américaine

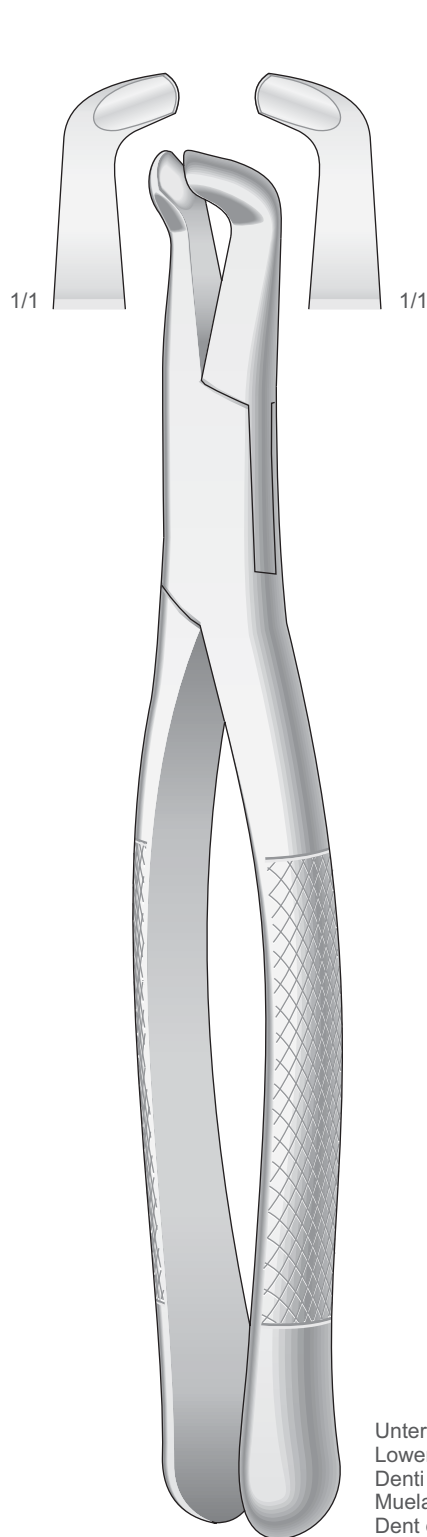

AM-222
Fig. 222

Untere Weisheitszähne
Lower wisdom teeth
Denti del giudizio inferiori
Muelas del juicio inferiores
Dent de sagesse inférieures

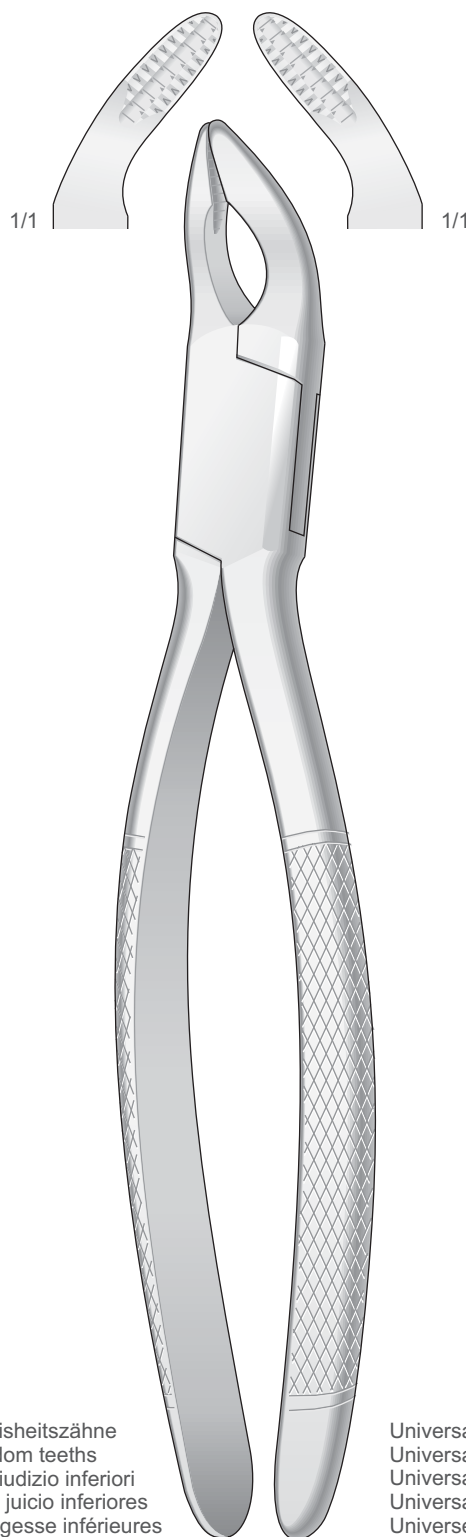

COHEN
AM-250

Universal
Universal
Universale
Universal
Universel

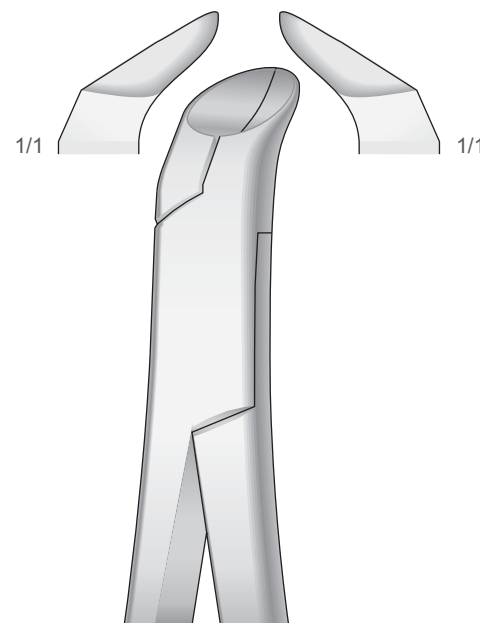

PHYSICK
AM-5
Fig. 5

Untere Weisheitszähne
Lower wisdom teeth
Denti del giudizio inferiori
Muelas del juicio inferiores
Dent de sagesse inférieures

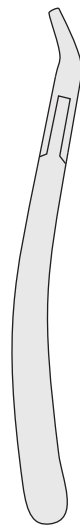
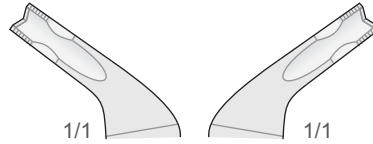
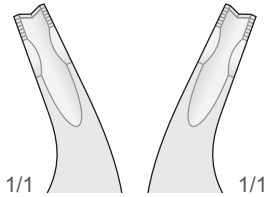

Obere
Upper
Superiori
Superiores
Supérieures

Prämolaren, Schneidezähne und Wurzeln
Bicuspid, incisors and roots
Premolari, incisivi e radici
Premolares, incisivos y raíces
Premolaires, incisives et racines

AM-150X
Fig. 150AS

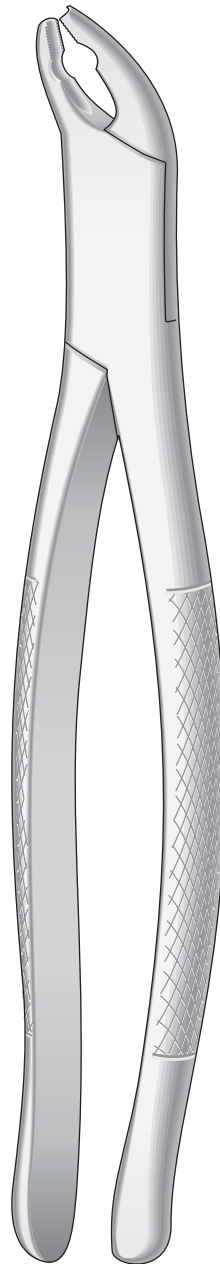

Untere
Lower
Inferiori
Inferiores
Inférieures

Prämolaren, Schneidezähne und Wurzeln
Bicuspid, incisors and roots
Premolari, incisivi e radici
Premolares, incisivos y raíces
Premolaires, incisives et racines

AM-151X
Fig. 151AS



Zahnzangen, Amerikanische Form
Extracting Forceps, American Pattern
Pinze per estrazione, Forma Americana
Pinzas da extracción, Forma Americana
Daviers, Forme Américaine

Für Kinder
For children
Per bambini
Para niños
Pour enfants

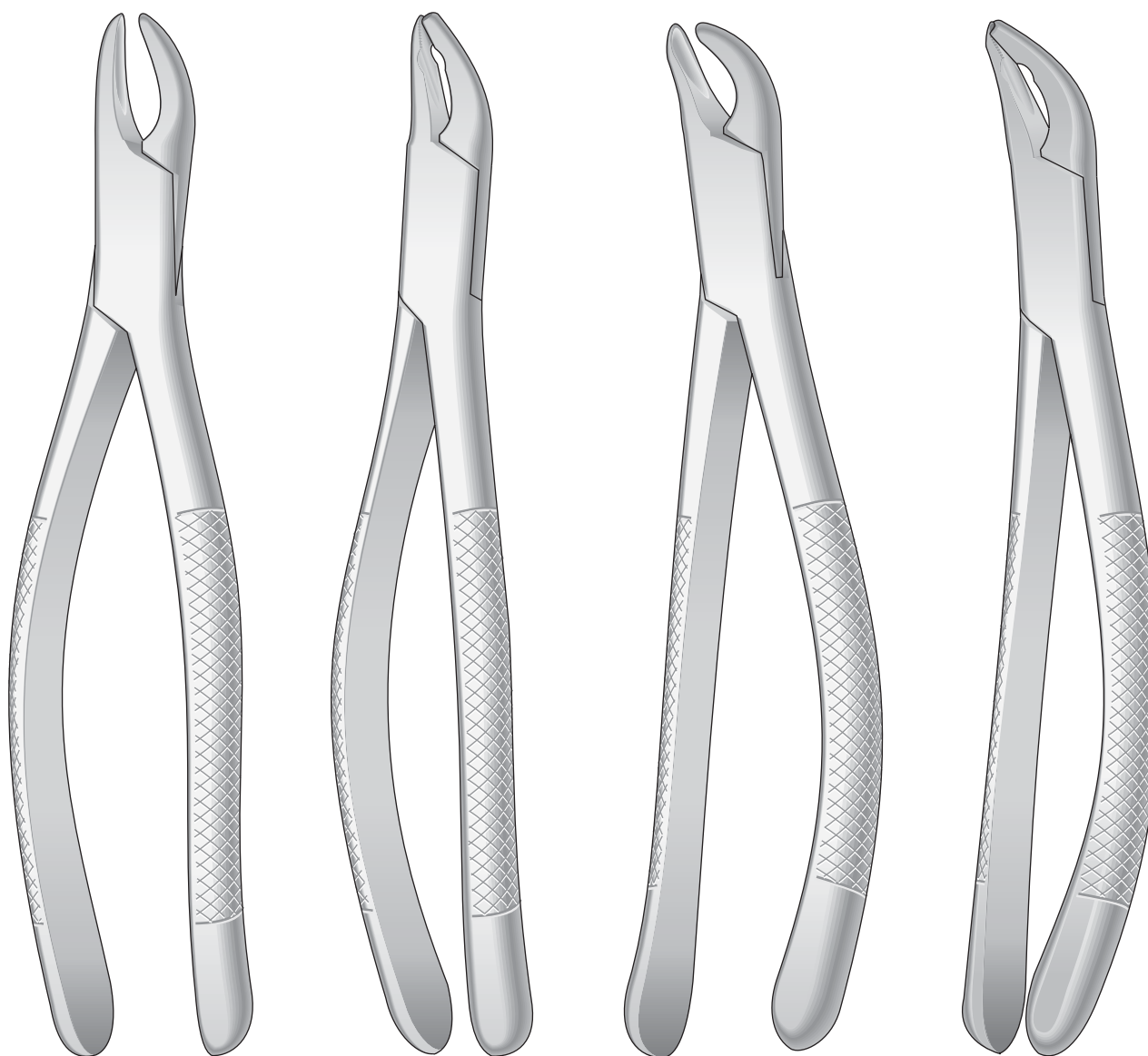
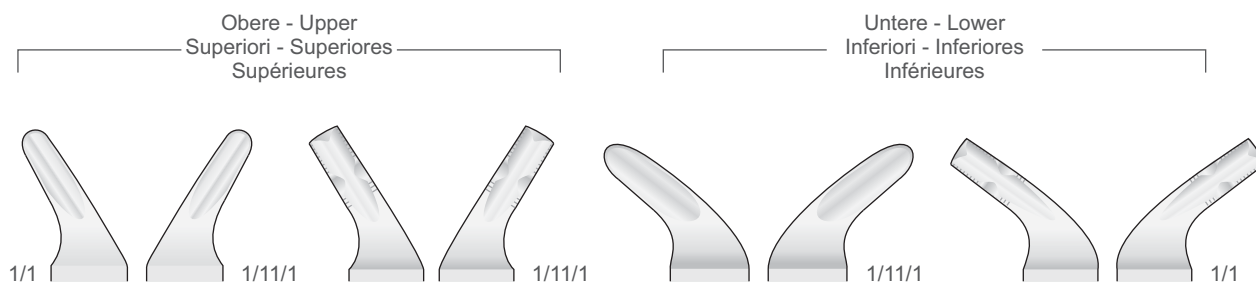

CRYER
AM-150S
Fig.150 S

AM-150AS
Fig.150 XAS

CRYER
AM-151S
Fig.151 S

AM-151AS
Fig.151 XAS

Geriefte - Serrated - Striata - Estriadas - Striées

Obere Schneidezähne, Prämolaren, Wurzeln
Upper incisors, premolars, roots
Incisivi, premolari e radici superiori
Incisivos, premolares y raíces superiores
Incisives, premolaires et racines supérieures

Untere Schneidezähne, Prämolaren, Wurzeln
Lower incisors, premolars, roots
Incisivi, premolari e radici inferiori
Incisivos, premolares y raíces inferiores
Incisives, premolaires et racines inférieures

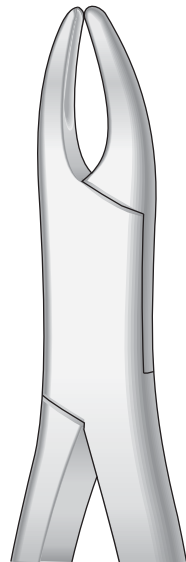
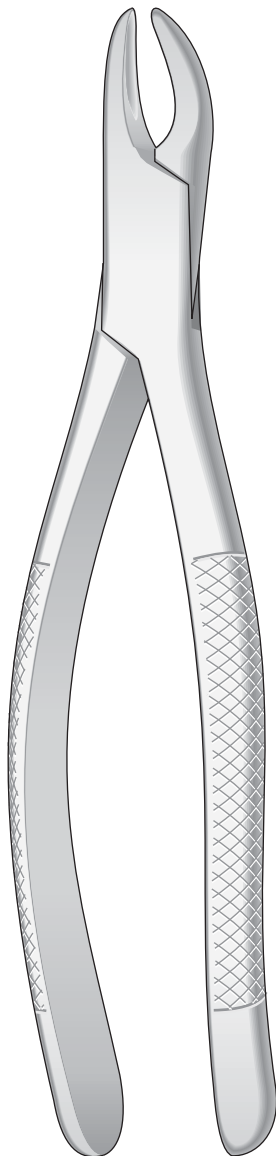
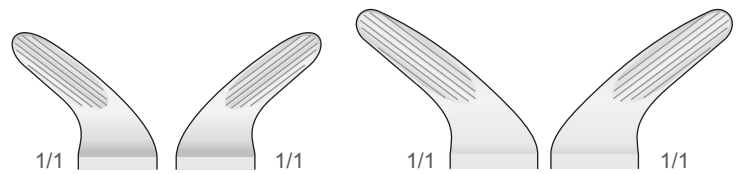
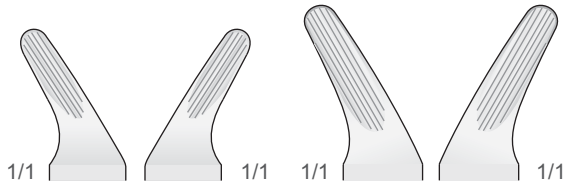

CRYER
AMG-150
Fig. 150

Für Erwachsene
For adults
Per adulti
Para adultos
Pour adults

Für Kinder
For children
Per bambini
Para niños
Pour enfants

CRYER
AMG-150S
Fig.150 S

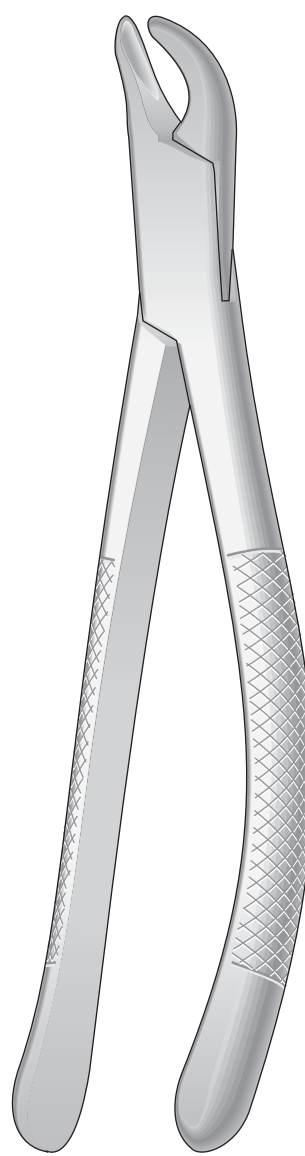

CRYER
AMG-151
Fig. 151

Für Erwachsene
For adults
Per adulti
Para adultos
Pour adults

Für Kinder
For children
Per bambini
Para niños
Pour enfants

CRYER
AMG-151S
Fig.151 S



Zahnzangen
Extracting Forceps
Pinze per estrazione
Pinzas da extracción
Daviers

Schneidezähne, Eckzähne, Wurzeln
Incisors, bicuspid and roots
Incisivi, canini e radici
Incisivos, caninos y raíces
Incisives, canines et racines

Molaren
Molars
Molari
Molares
Molaires

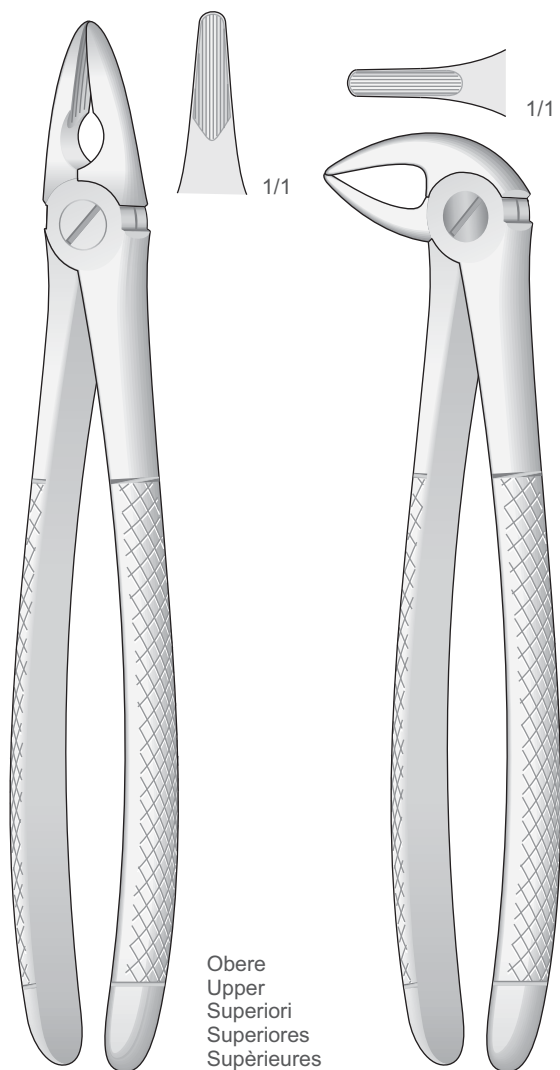

MEAD
MD-1

MEAD
MD-3

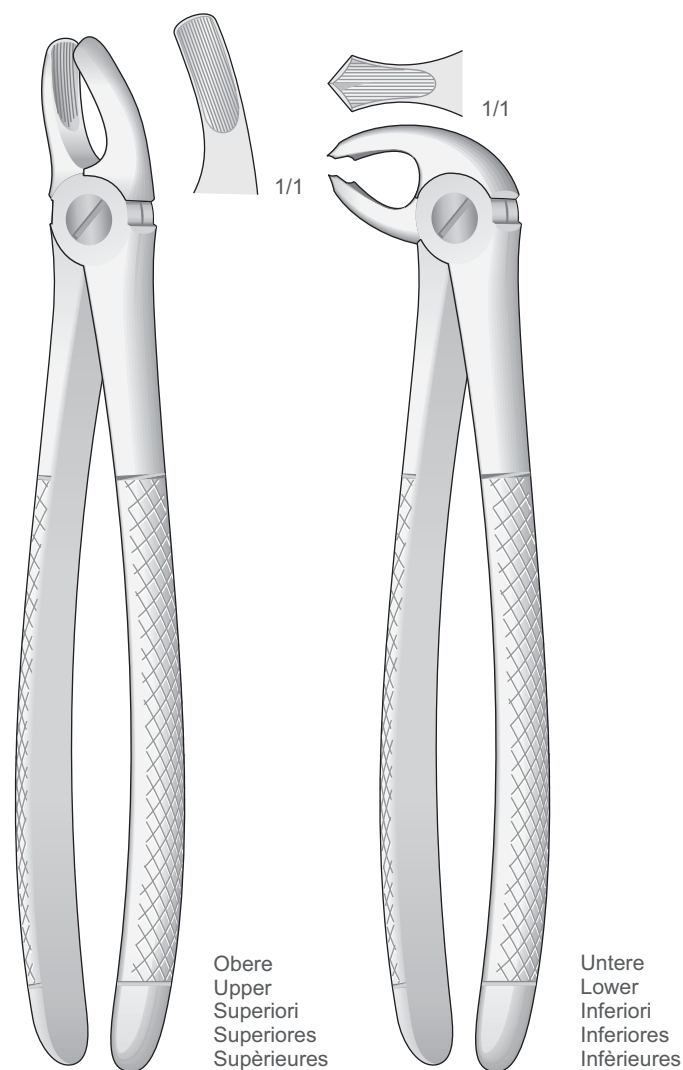

MEAD
MD-2

MEAD
MD-4

Kinderzahnzangen, Amerikanische Form
 Extracting Forceps for children, American Pattern
 Pinze per estrazione per bambini, Forma Americana
 Forceps dentales para niños, Forma Americana
 Daviers pour enfants, Forme Américaine

Molaren
 Pedo Lower Molars
 Molari
 Molares
 Molaires

Molaren
 Pedo Lower Molars
 Molari
 Molares
 Molaires

Zähne und wurzeln
 Pedo upper incisors
 Bicuspid and roots
 Denti e radici
 Dientes y raíces
 Dentes et racines

Zähne und wurzeln
 Pedo lower incisors
 Bicuspid and roots
 Denti e radici
 Dientes y raíces
 Dentes et racines

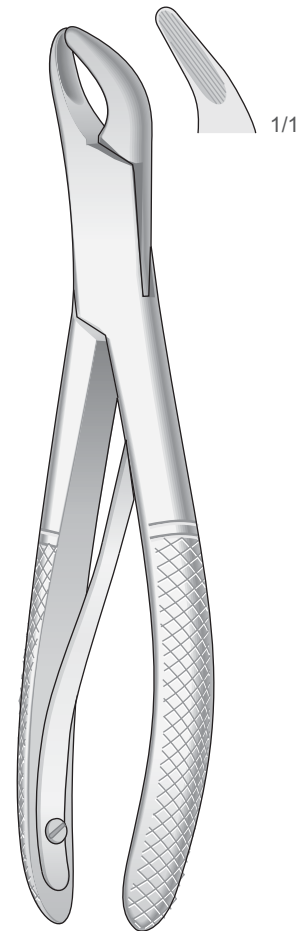
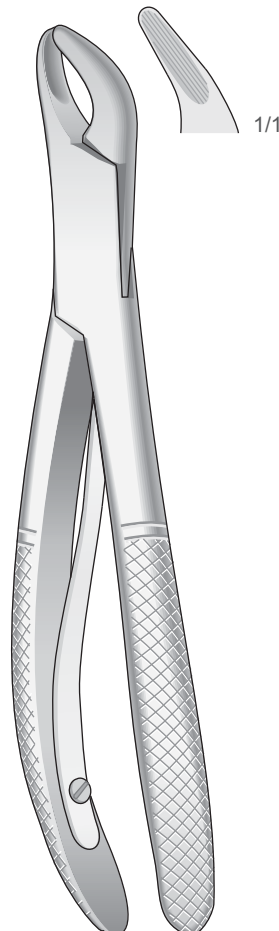
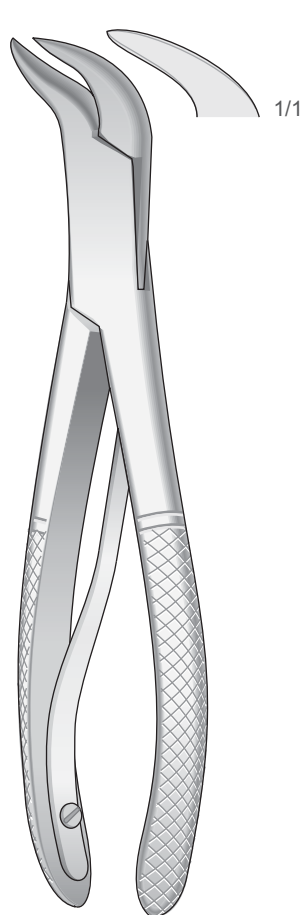
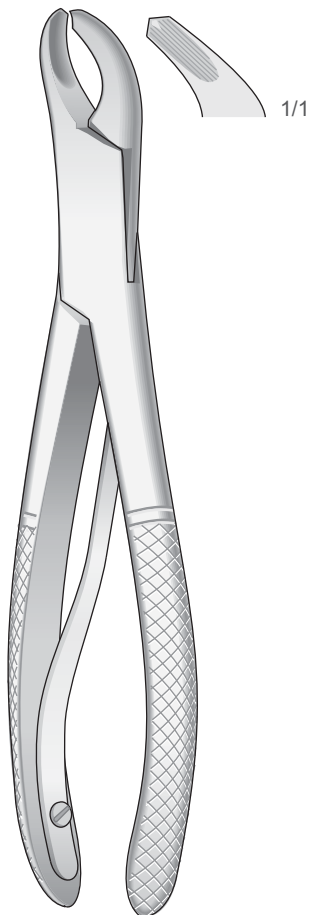

PEB-17S
 Fig. 17SK

PEB-23S
 Fig. 23SK

PEB-150S
 Fig. 150SK

PEB-151S
 Fig. 151SK



Kinderzahnzangen
Extracting Forceps for children
Pinze per estrazione per bambini
Forceps dentales para niños
Daviers pour enfants

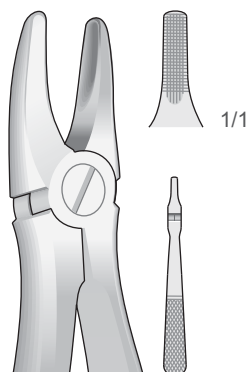

PEB-1
Fig. 137

Obere Schneidezähne
Upper Incisors
Incisivi superiori
Incisivos superiores
Incisives supérieures

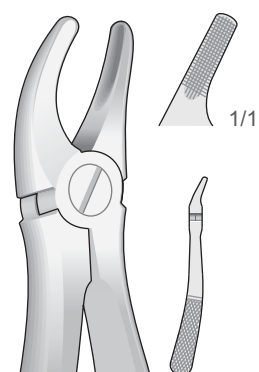

PEB-2
Fig. 139

Obere Prämolaren
Upper Premolars
Premolari superiori
Premolares superiores
Prémolaires supérieures

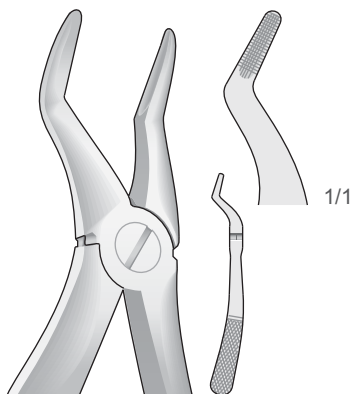

PEB-4
Fig. 51S

Obere Wurzeln
Upper roots
Radici superiori
Raíces superiores
Racines supérieures

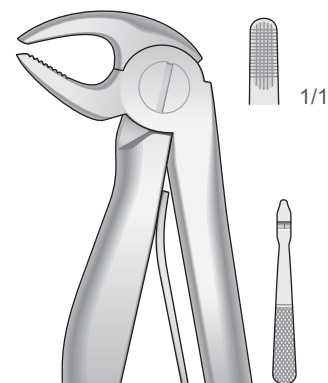

PEB-5
Fig. 5

Untere Schneidezähne
Lower incisors
Incisivi inferiori
Incisivos inferiores
Incisives inférieures

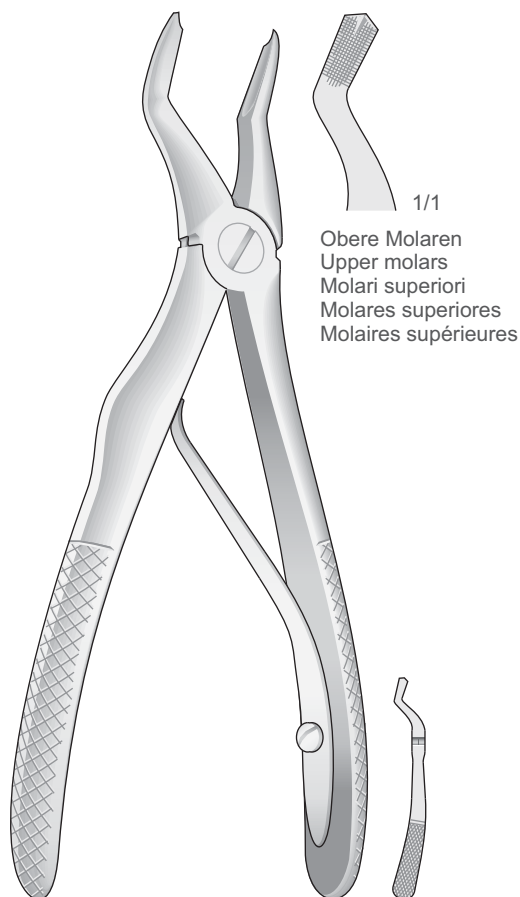

PEB-3

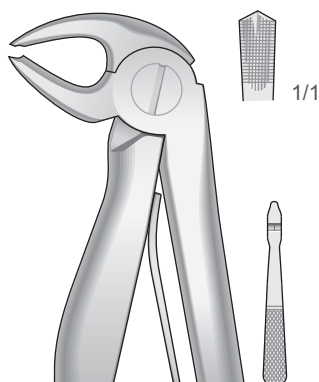

PEB-6
Fig. 6

Untere Molaren
Lower Molars
Molari inferiori
Molares inferiores
Molaires inférieures

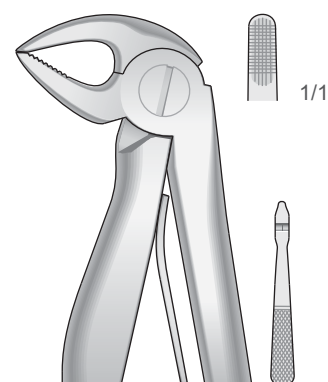

PEB-7
Fig. 7

Untere Wurzeln
Lower roots
Radici inferiori
Raíces inferiores
Racines inférieures

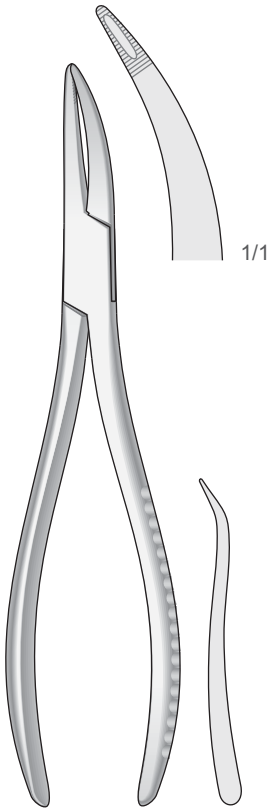

Obere Wurzeln, Universal
Upper roots, Universal
Radici superiori, Universale
Raices superiores, Universal
Racines superieures, Universel

WITZEL
DK-26
170 mm

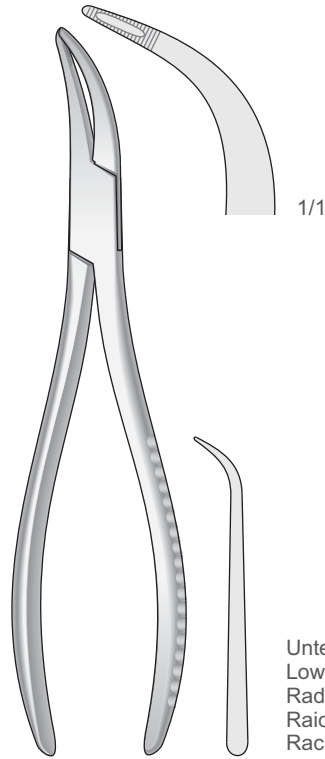

Untere Wurzeln, Universal
Lower roots, Universal
Radici inferiori, Universale
Raices inferiores, Universal
Racines inferieures, Universel

WITZEL
DK-28
165 mm

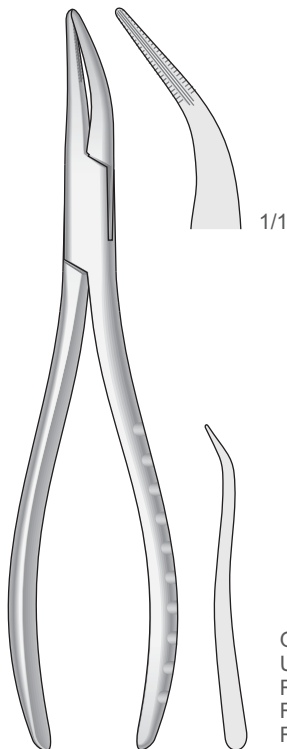

Obere Wurzeln, Universal
Upper roots, Universal
Radici superiori, Universale
Raices superiores, Universal
Racines superieures, Universel

400 (300)
165 mm

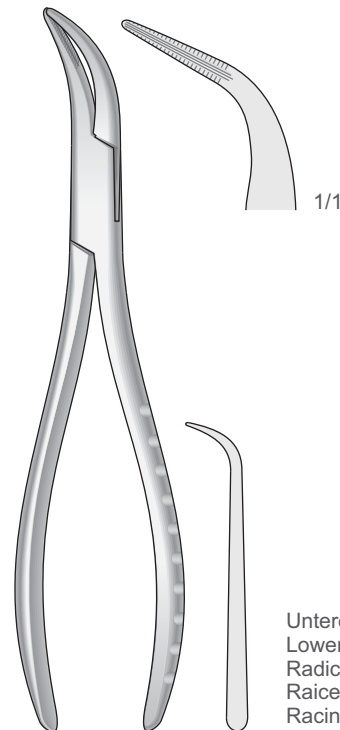

Untere Wurzeln, Universal
Lower roots, Universal
Radici inferiori, Universale
Raices inferiores, Universal
Racines inferieures, Universel

401 (301)
160 mm



Wurzelfragmentinstrumente
Root Fragment Forceps
Strumenti per frammenti di radici
Instrumentos para fragmentos de raíces
Instruments pour fragments de racines

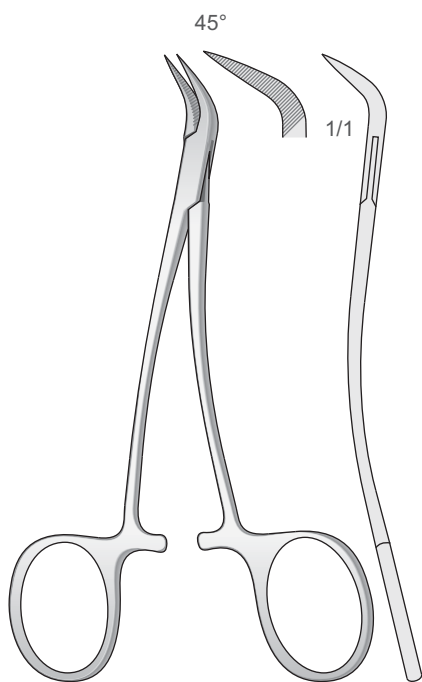

PEET
DR-40
120 mm

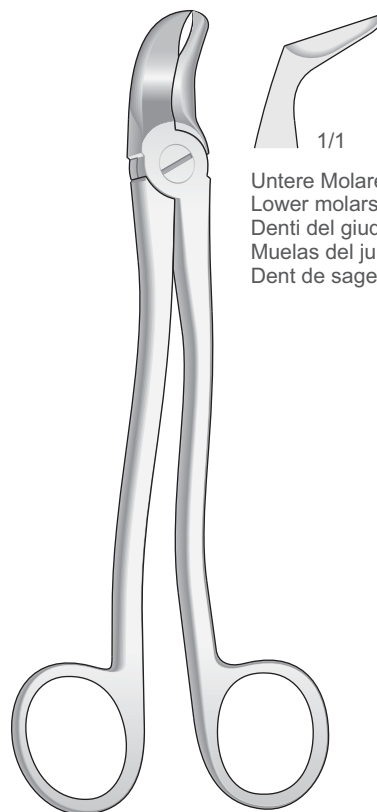

RO-1
175 mm

Untere Molaren und Weisheitszähne
Lower molars and wisdom teeth
Denti del giudizio e molari inferiori
Muelas del juicio y molares inferiores
Dent de sagesse et molaires inférieures

Wurzelfragmente
Root fragments
Frammenti di radici
Fragmentos de raíces
Fragments de racines

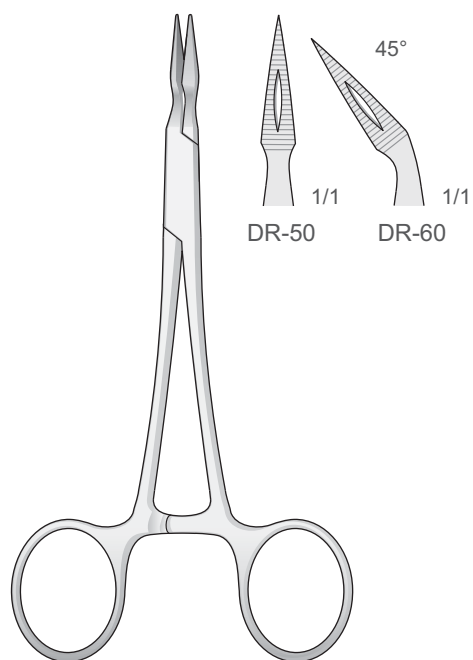

STIEGLITZ
DR-50/DR-60
140 mm

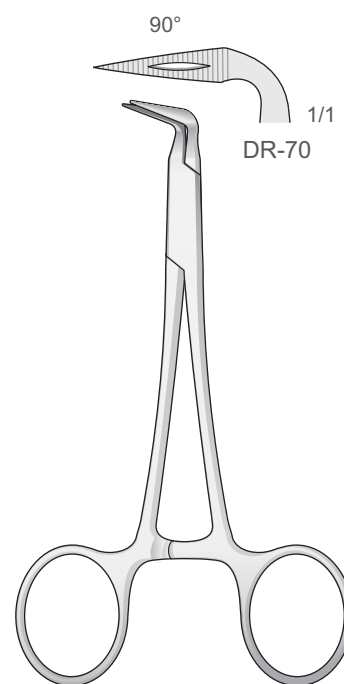

STIEGLITZ
DR-70
120 mm

Wurzelfragmentinstrumente
Root Fragment Forceps
Strumenti per frammenti di radici
Instrumentos para fragmentos de raíces
Instruments pour fragments de racines

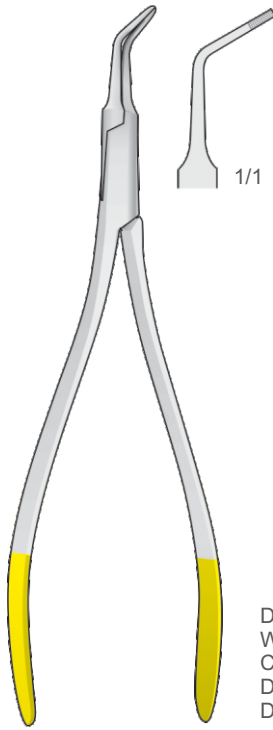

DA-01M
130 mm

Diamantiert
With Diamond
Con diamante
Diamantada
Diamantées

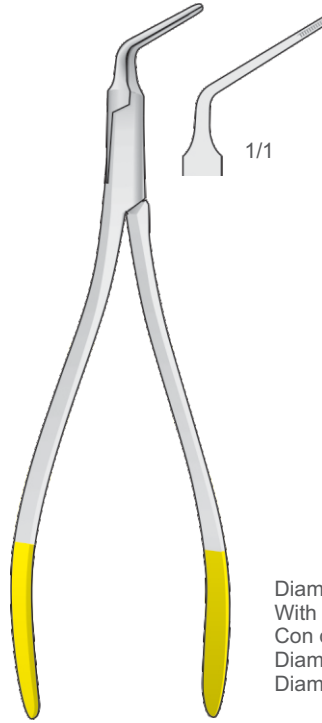

DA-10
130 mm

Diamantiert
With Diamond
Con diamante
Diamantada
Diamantées

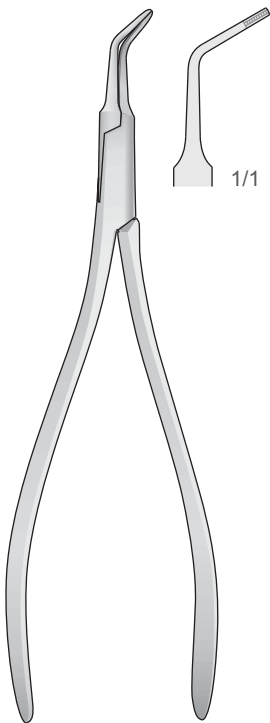

DA-01

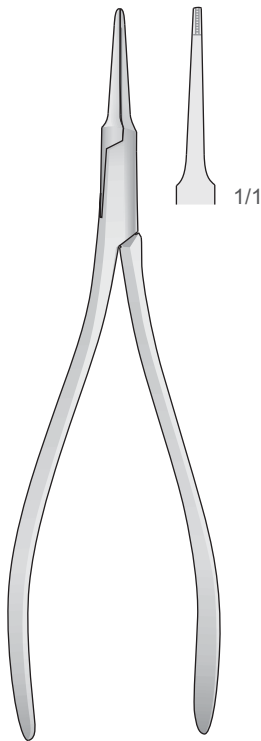

DA-02

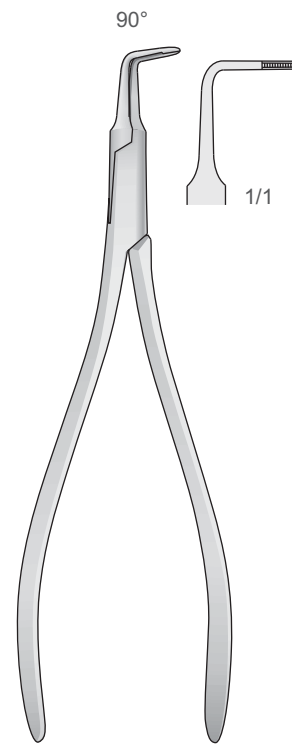

DA-03

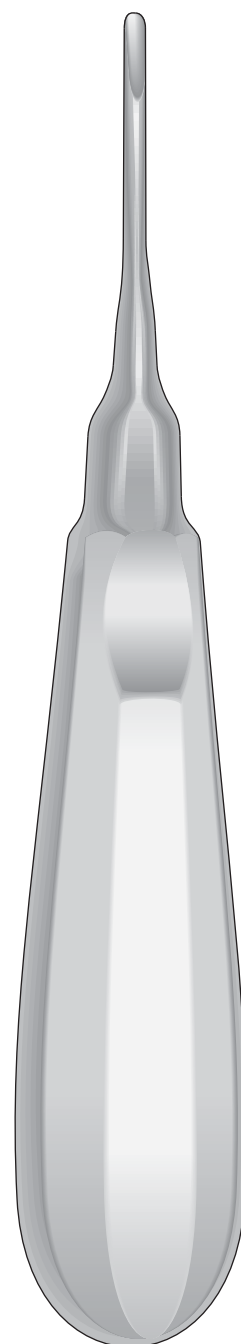

02 |

Root Elevators

Wurzelheber

Elevatori per radici

Elevadores para raíces

Élévateurs pour racines



Wurzelheber
Root Elevators
Leve per radici
Elevadores para raíces
Elevateurs à racines

SMALL HANDLE

Luxatoren - Luxators
Lussatori - Luxadores
Luxateurs

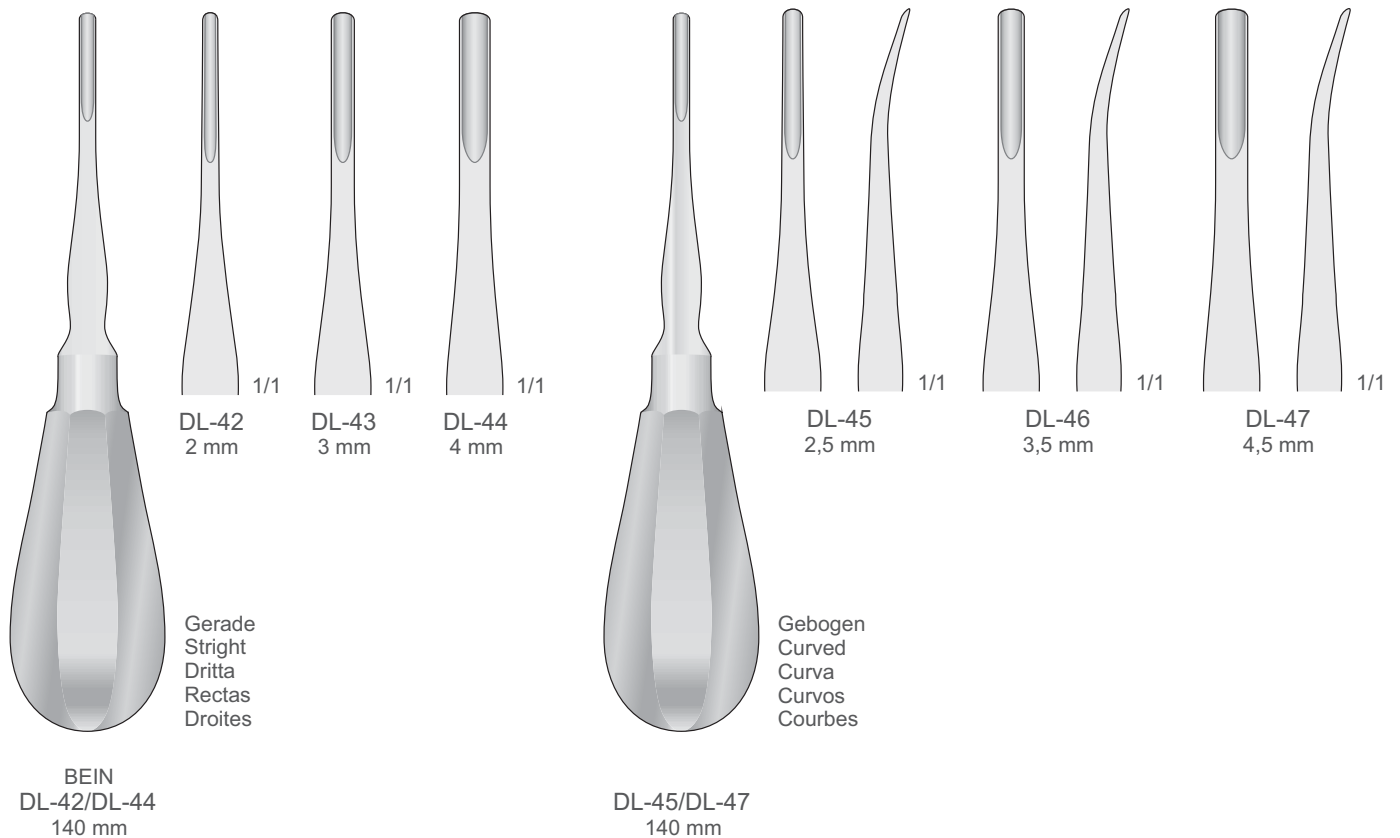
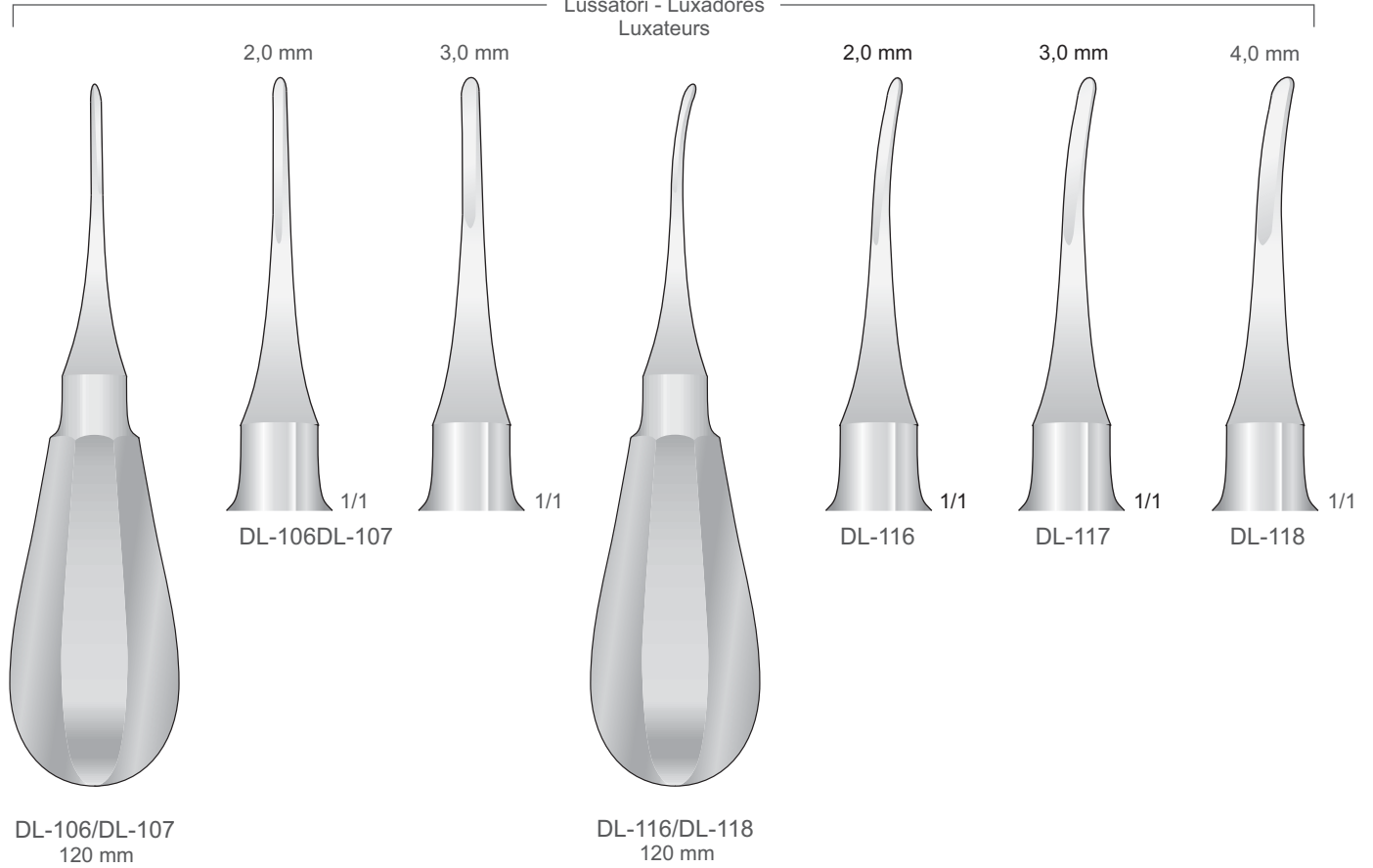

2,0 mm

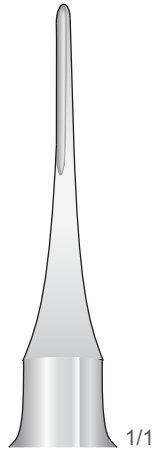

DL-81
150 mm

2,5 mm

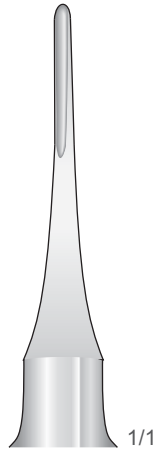

DL-82
150 mm

3,0 mm

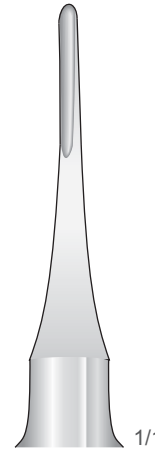

DL-83
150 mm

3,5 mm

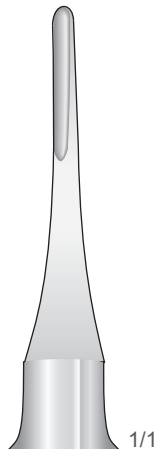

DL-84
150 mm

4,0 mm

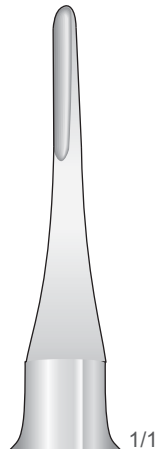

DL-85
150 mm

4,5 mm

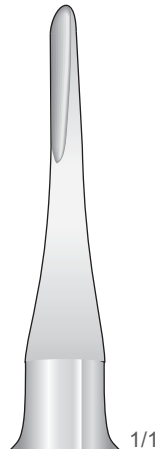

DL-86
150 mm

5,0 mm

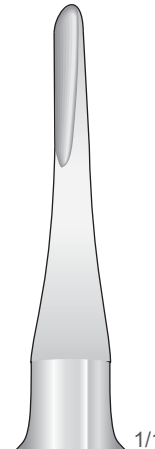

DL-87
150 mm

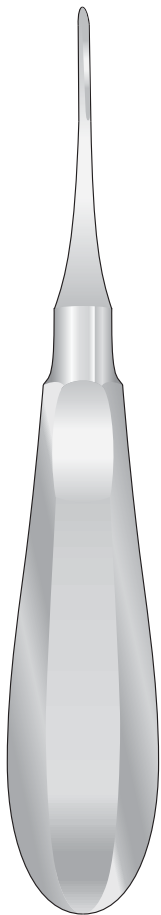

DL-81/DL-87
150 mm



Wurzelheber
Root Elevators
Leve per radici
Elevadores para raices
Elevateurs à racines

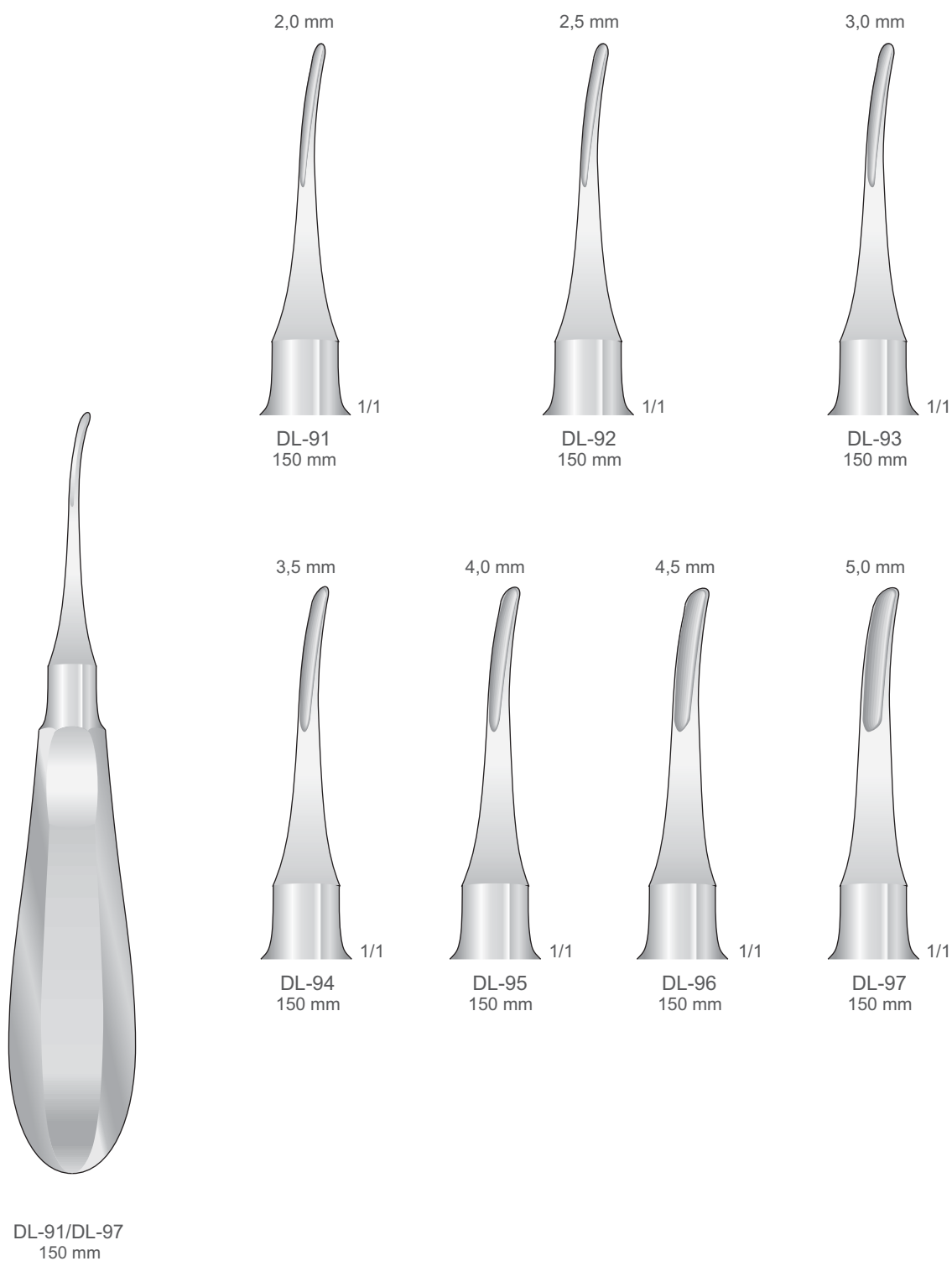

Luxatoren
Luxators
Lussatori
Luxadores
Luxateurs

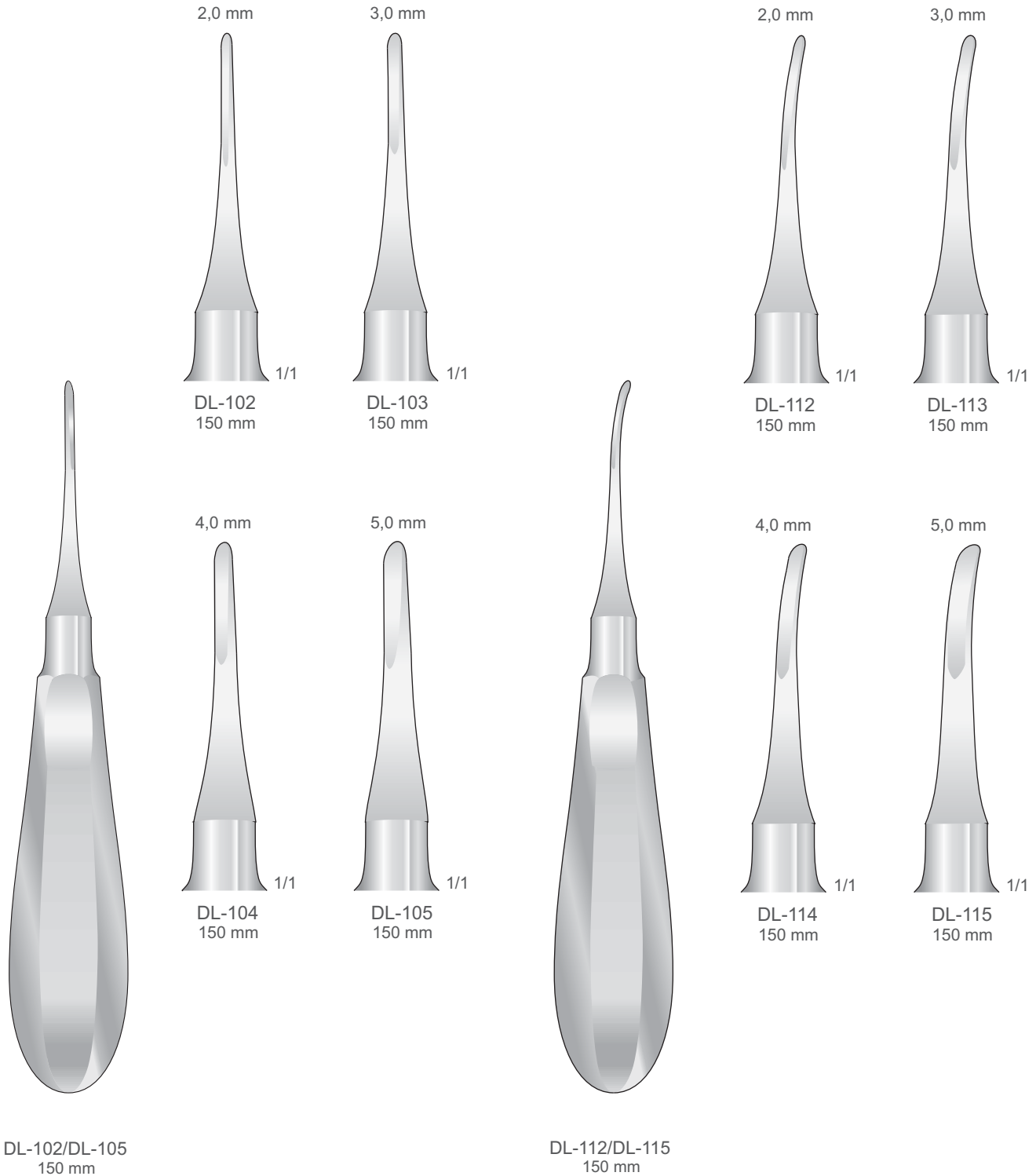



Wurzelheber
Root Elevators
Leve per radici
Elevadores para raices
Elevateurs à racines

02

Wurzelspitzenheber
Root fragment Elevators
Leve per frammenti di radice
Elevadores para fragmentos de raices
Elévateurs de fragments de racines

Gezahnt
Serrated
Dentellata
Dentada
Dentelé

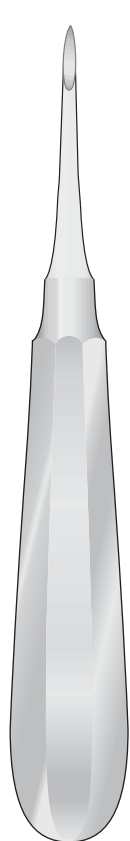

HEIDBRINK
HE-1
140 mm

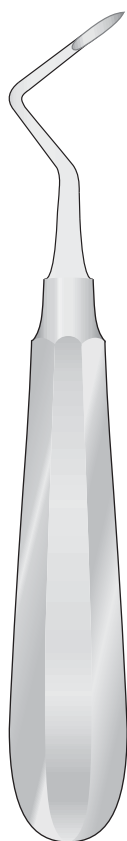

HEIDBRINK
HE-2
140 mm

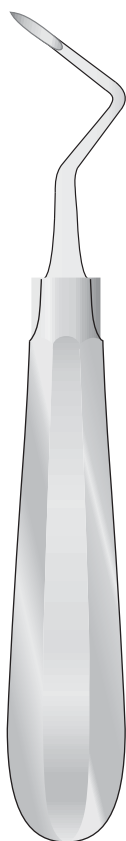

HEIDBRINK
HE-3
140 mm

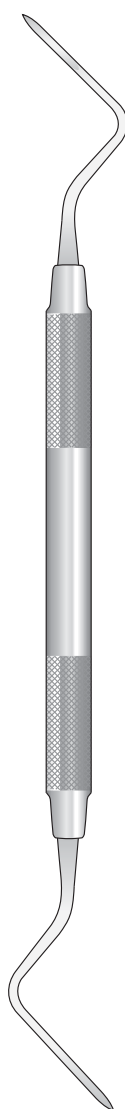

HEIDBRINK
725-1/2
195 mm

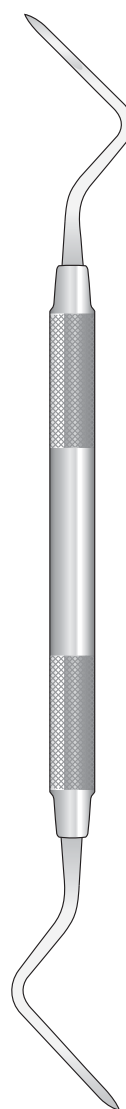

HEIDBRINK
725-3/4
195 mm

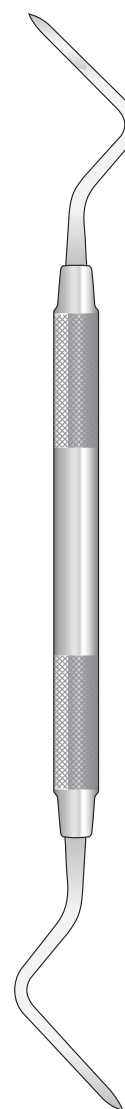

HEIDBRINK
725-5/6
195 mm

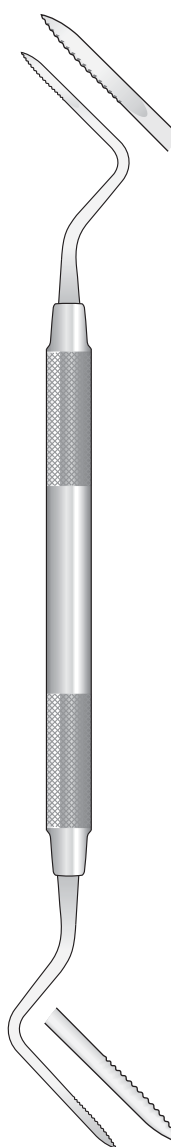

HEIDBRINK
725-3/4S
195 mm

Extraktionshebel für obere Weisheitszähne
Luxator for upper wisdom teeth
Leva per estrazione dente del giudizio superiore
Elevador de extracción de muelas del juicio superiores
Levier d'extraction pour dent de sagesse supérieures

Wurzelheber
Root Elevators
Leve per radici
Elevadores para raíces
Elévateurs de racines

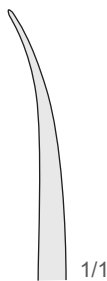

1/1

ROSIN
DL-58
160 mm



Obere
Upper
Superiori
Superiores
Supérieures

WARWICK-JAMES
DL-20
160 mm



Untere
Lower
Inferiori
Inferiores
Inférieures

WARWICK-JAMES
DL-21
155 mm

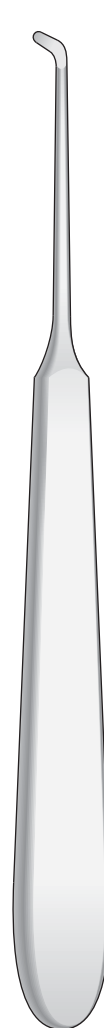

Untere
Lower
Inferiori
Inferiores
Inférieures

WARWICK-JAMES
DL-22
155 mm



Wurzelheber
Root Elevators
Leve per radici
Elevadores para raíces
Elevateurs à racines

Eine seite gezahnt
One side serrated
Un lato dentellato
Dentadura mäs lado
Dentelure sur un côté

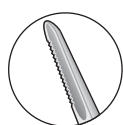
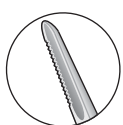
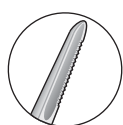

Fig. 94



DL-76
155 mm

Fig. 95



DL-77
155 mm

Fig. 100L



DL-78
155 mm

Fig. 100R



DL-79
155 mm



Gezahnt
Serrated
Dentellate
Dentadas
Dentelé

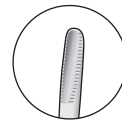
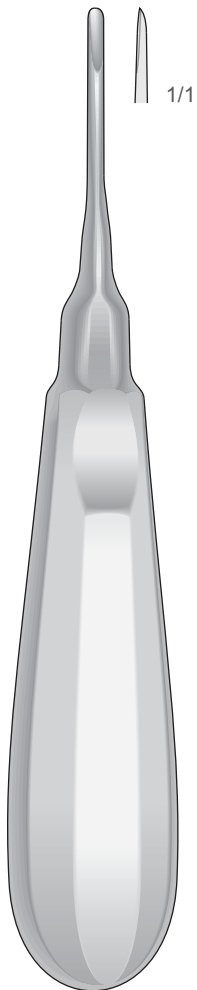
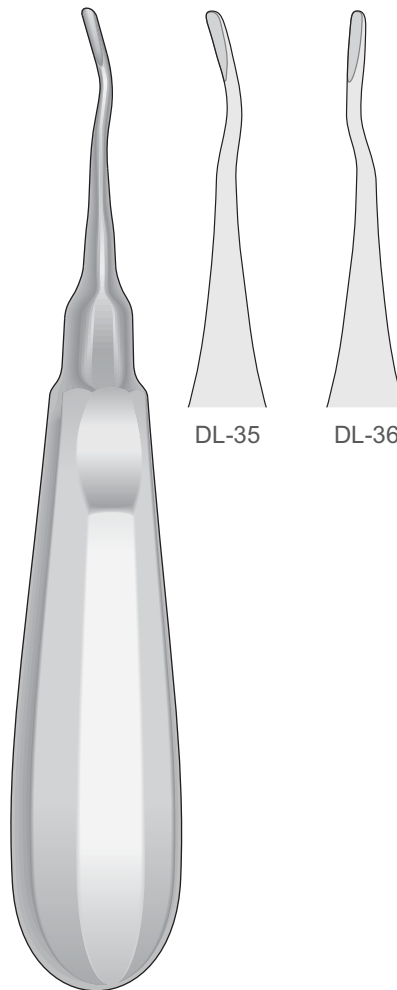

Fig. 301



APEXO
DL-34
160 mm

Fig. 302 Fig. 303



DL-35

DL-36

APEXO
DL-35/DL-36
160 mm

Fig. 77L Fig. 77R

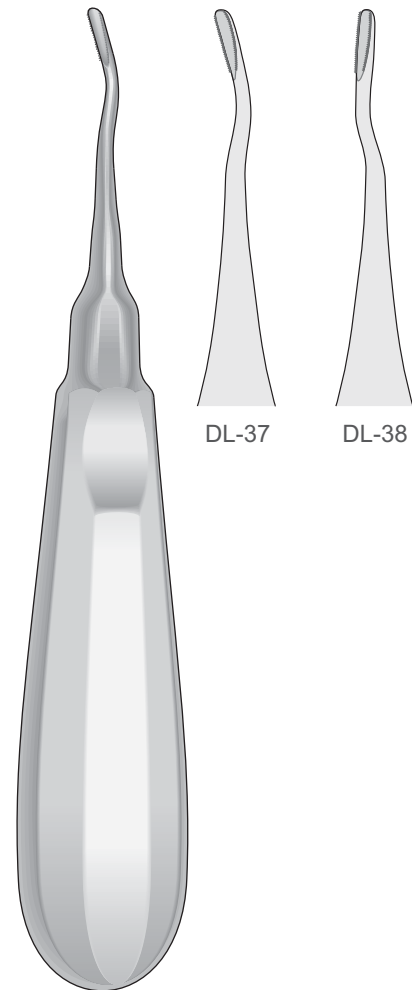

DL-37

DL-38

APEXO
DL-37/DL-38
160 mm



Wurzelheber
Root Elevators
Leve per radici
Elevadores para raíces
Elevateurs à racines

02

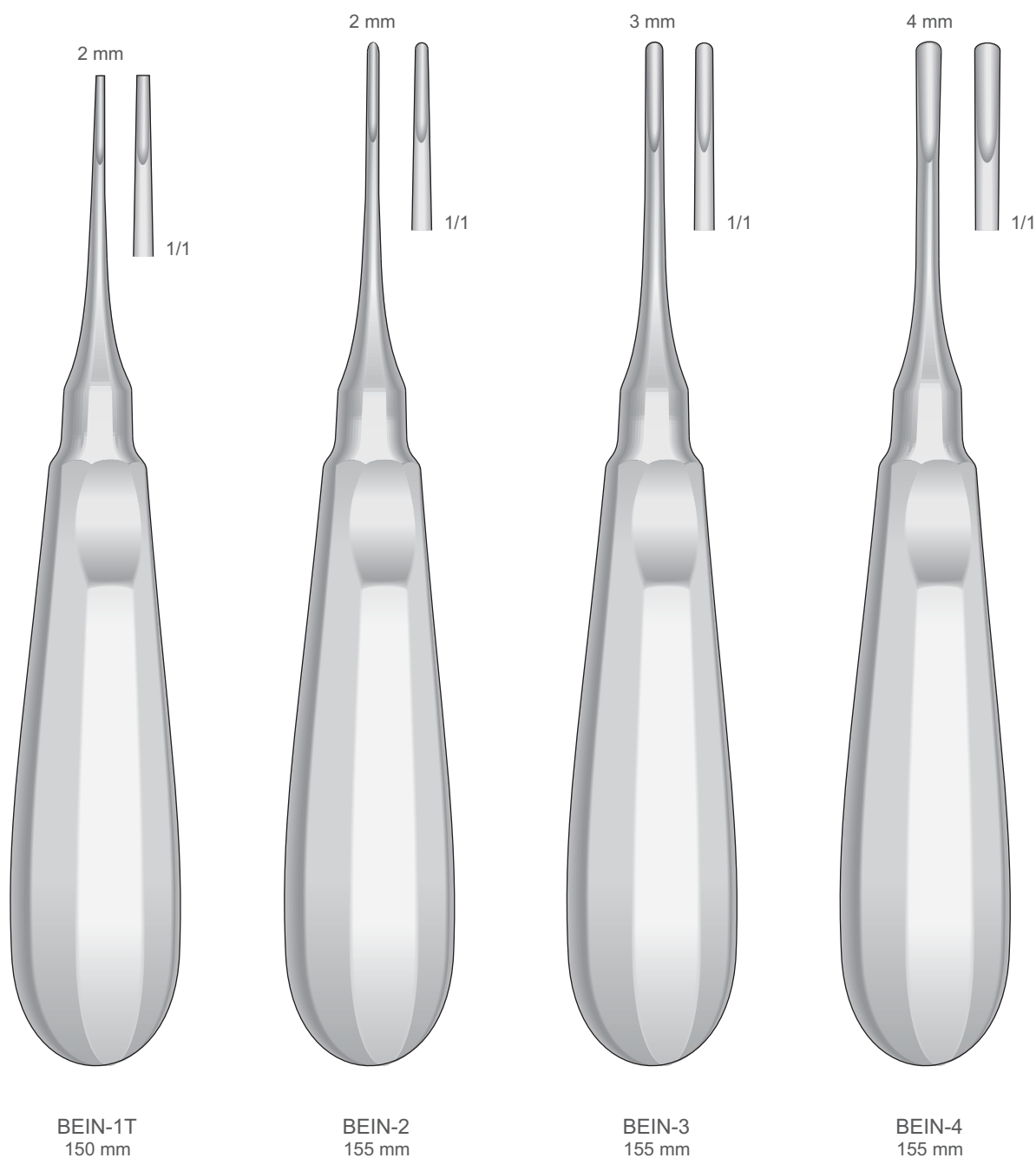

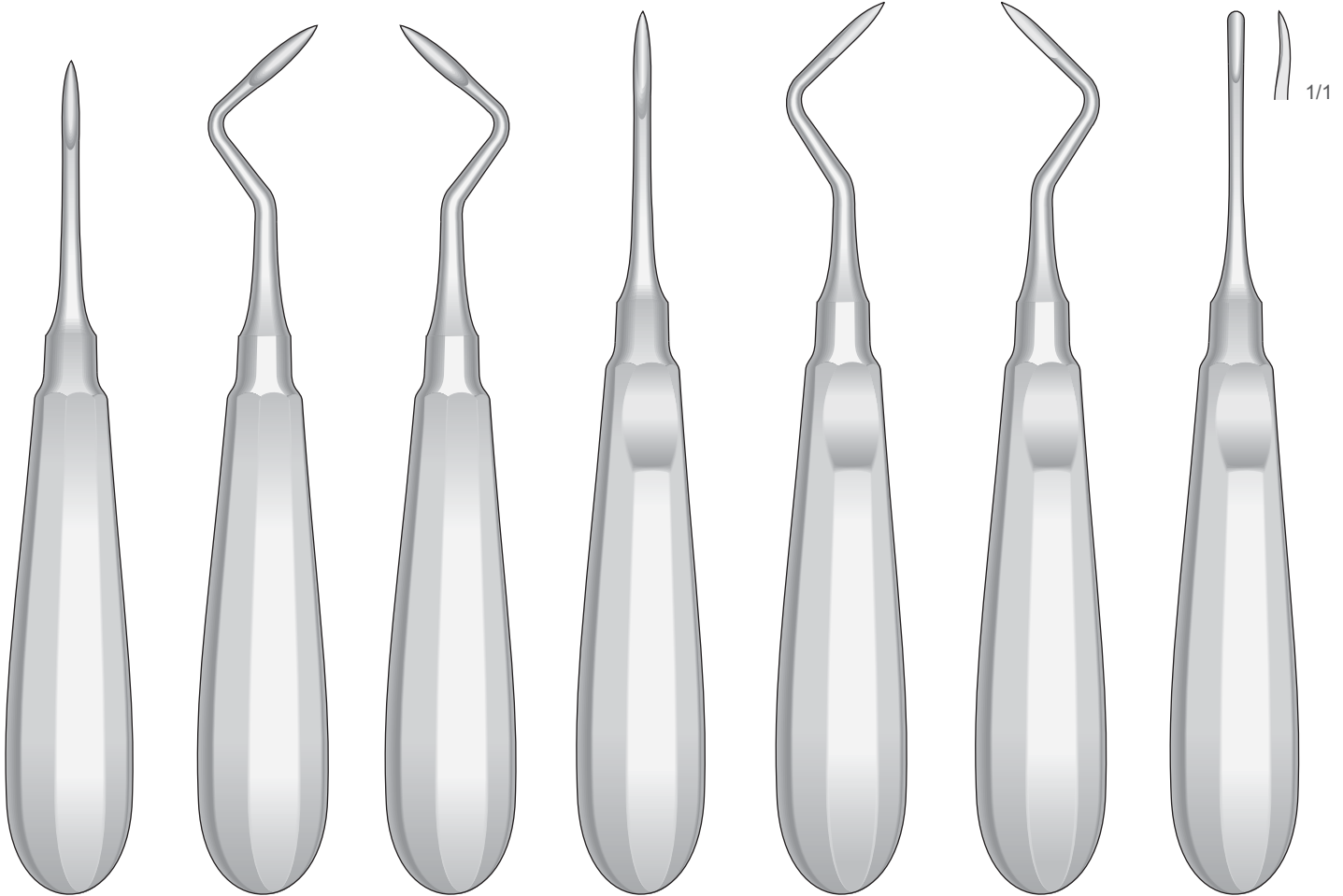

FLOHR-1
140 mm

FLOHR-2
150 mm

FLOHR-3
150 mm

APICAL-1
155 mm

APICAL-2
155 mm

APICAL-3
155 mm

APICAL-4
155 mm



Wurzelheber
Root Elevators
Leve per radici
Elevadores para raíces
Elevateurs à racines

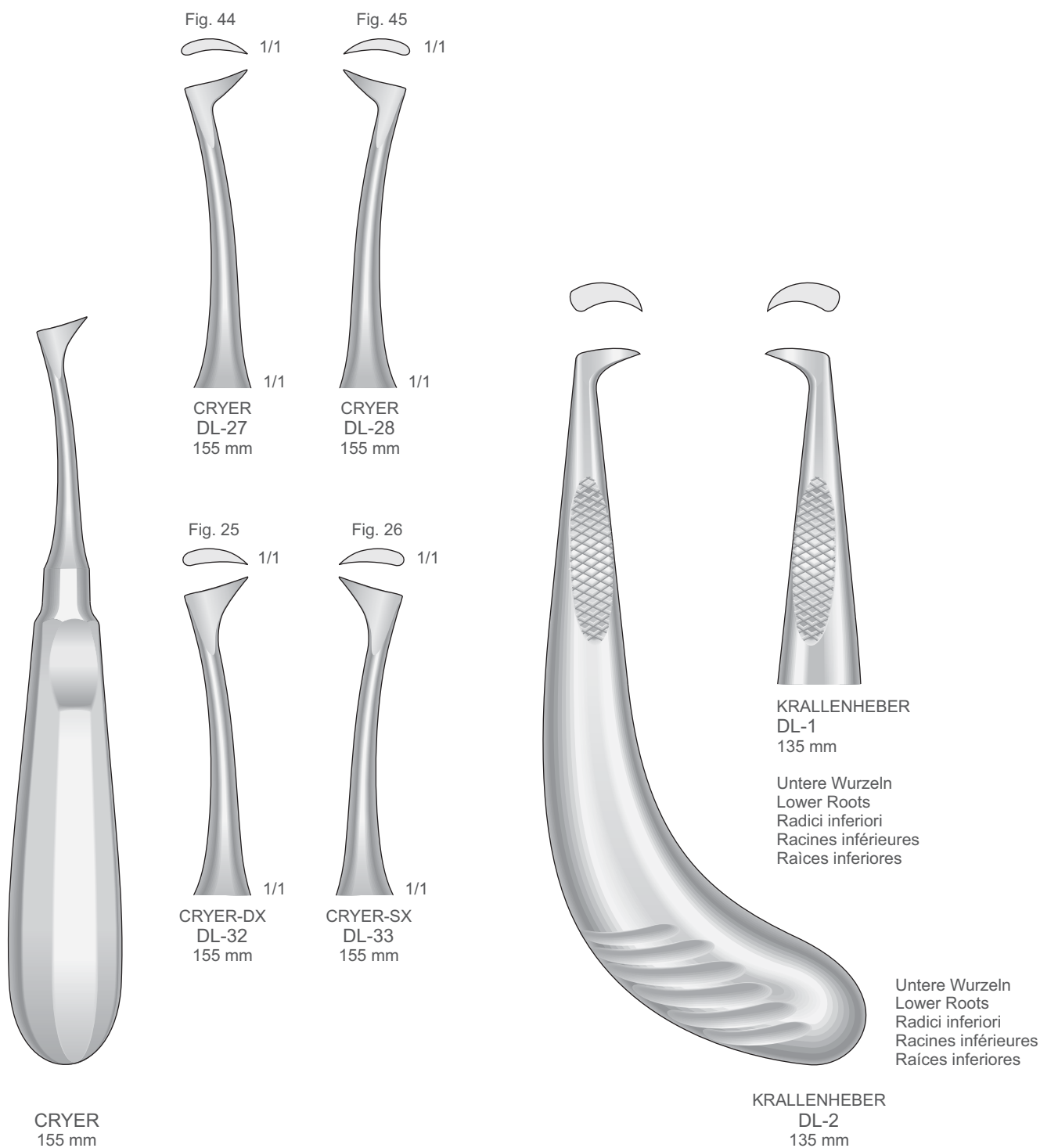

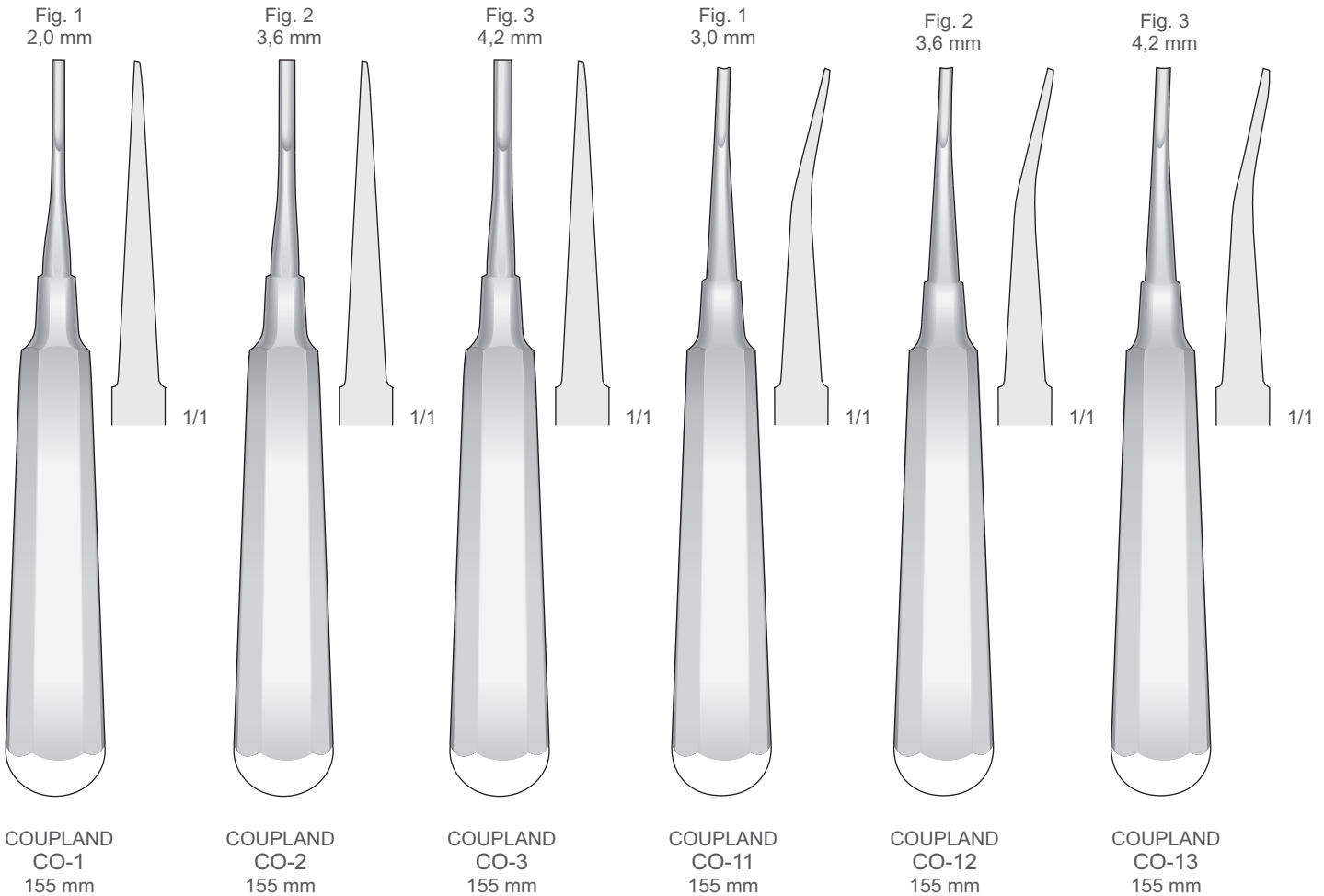
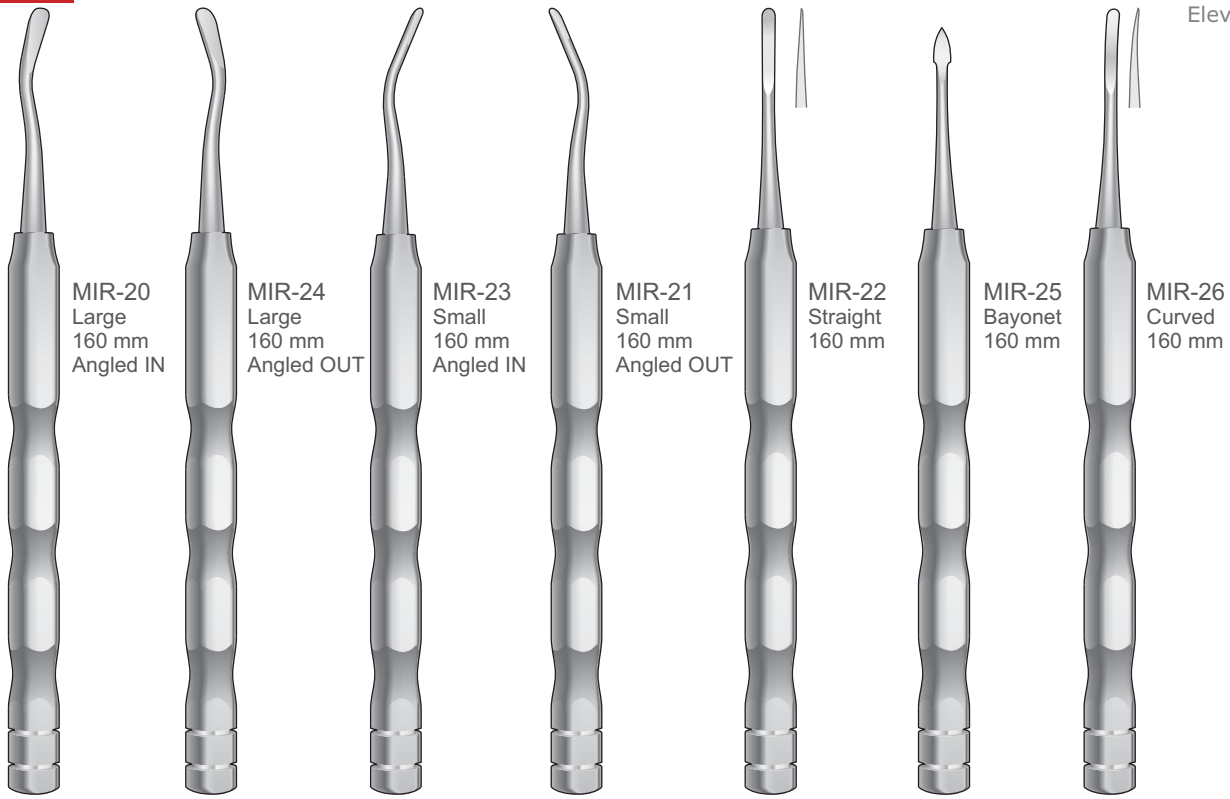



Wurzelheber
Root Elevators
Leve per radici
Elevadores para raíces
Elevateurs à racines

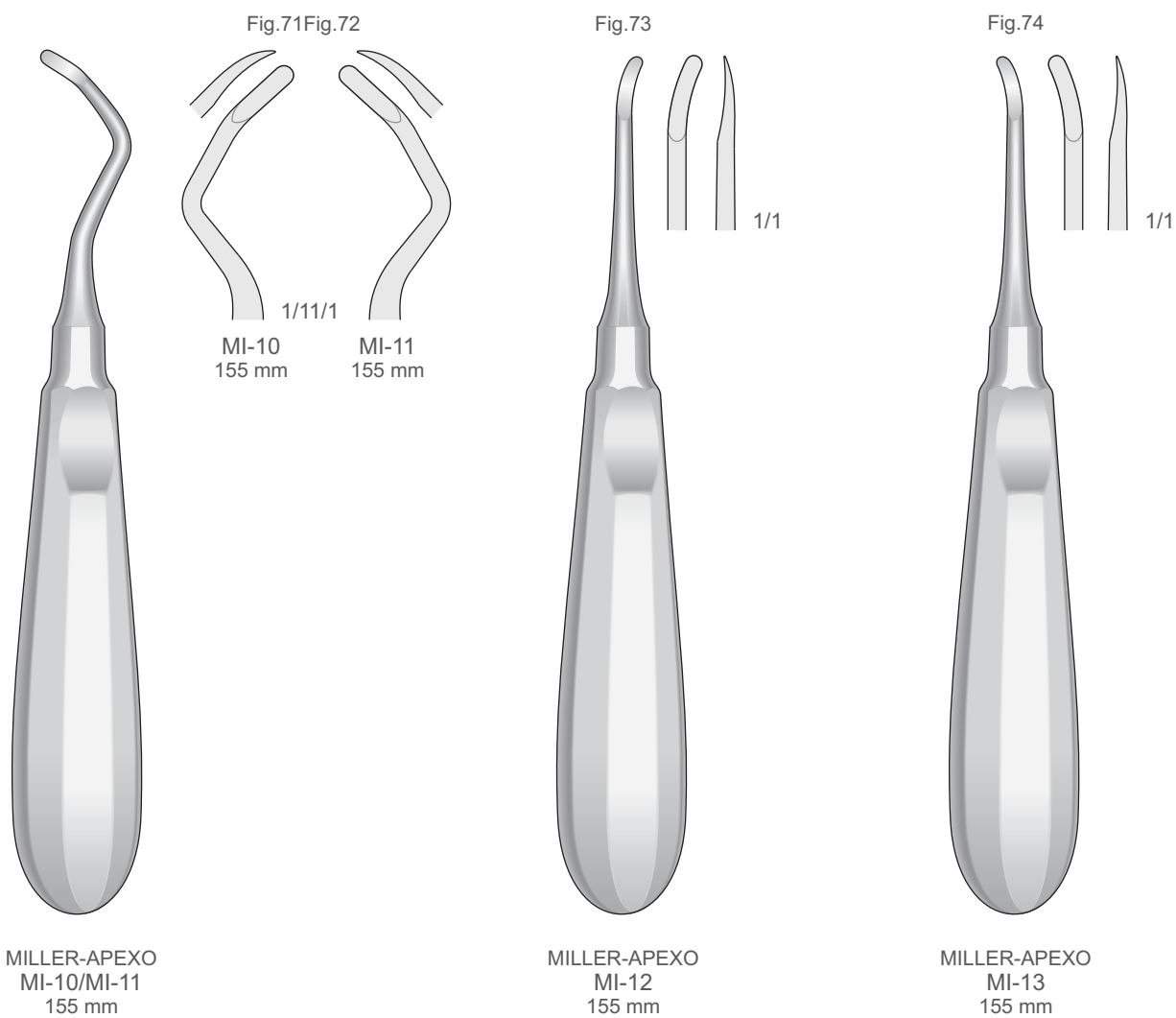

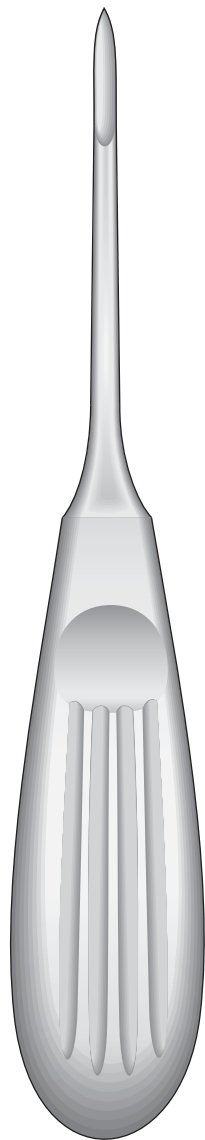

HYLIN
DL-11/DL-19
145 mm

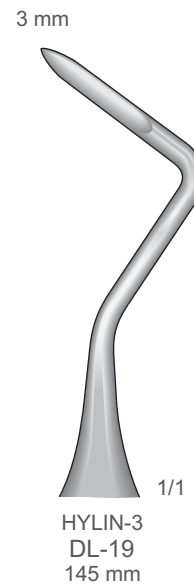
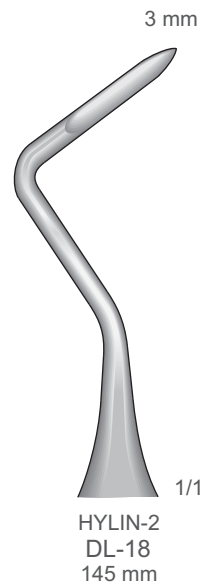
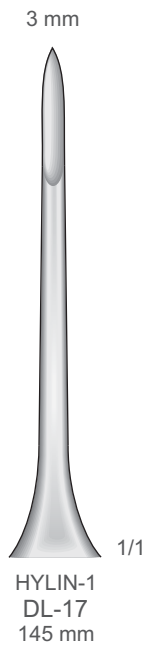
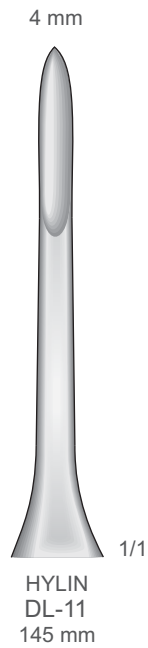



Wurzelheber
Root Elevators
Leve per radici
Elevadores para raíces
Elevateurs à racines

02

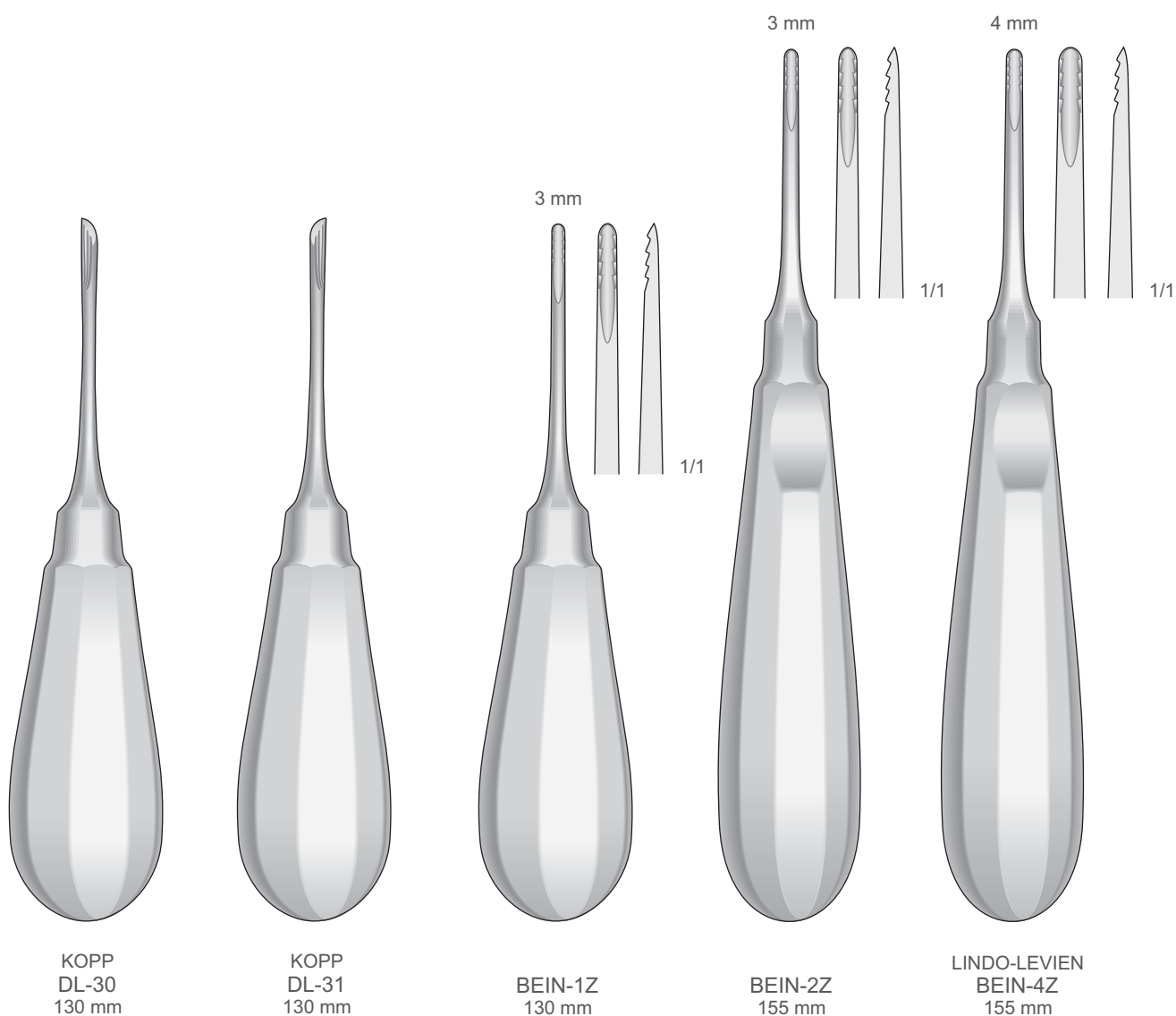

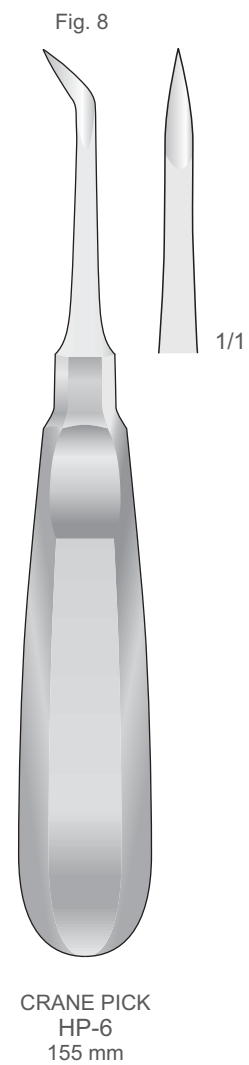
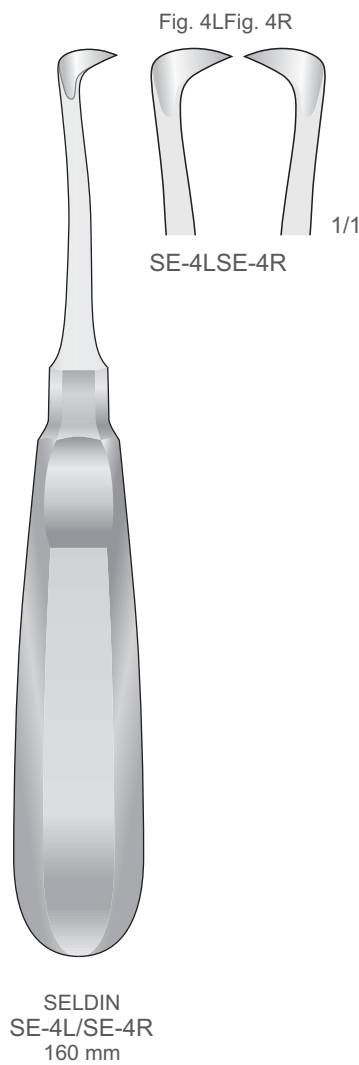
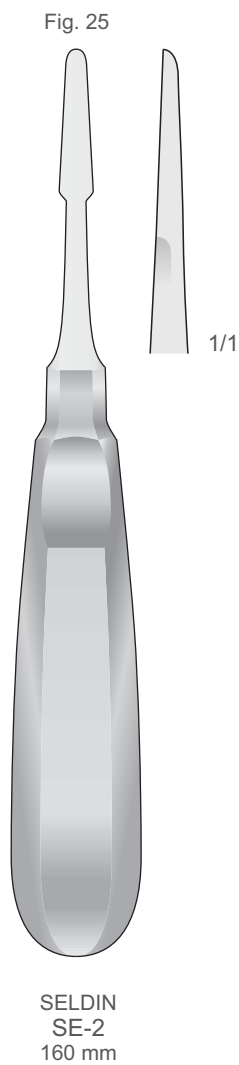



Wurzelheber
Root Elevators
Leve per radici
Elevadores para raíces
Elevateurs à racines

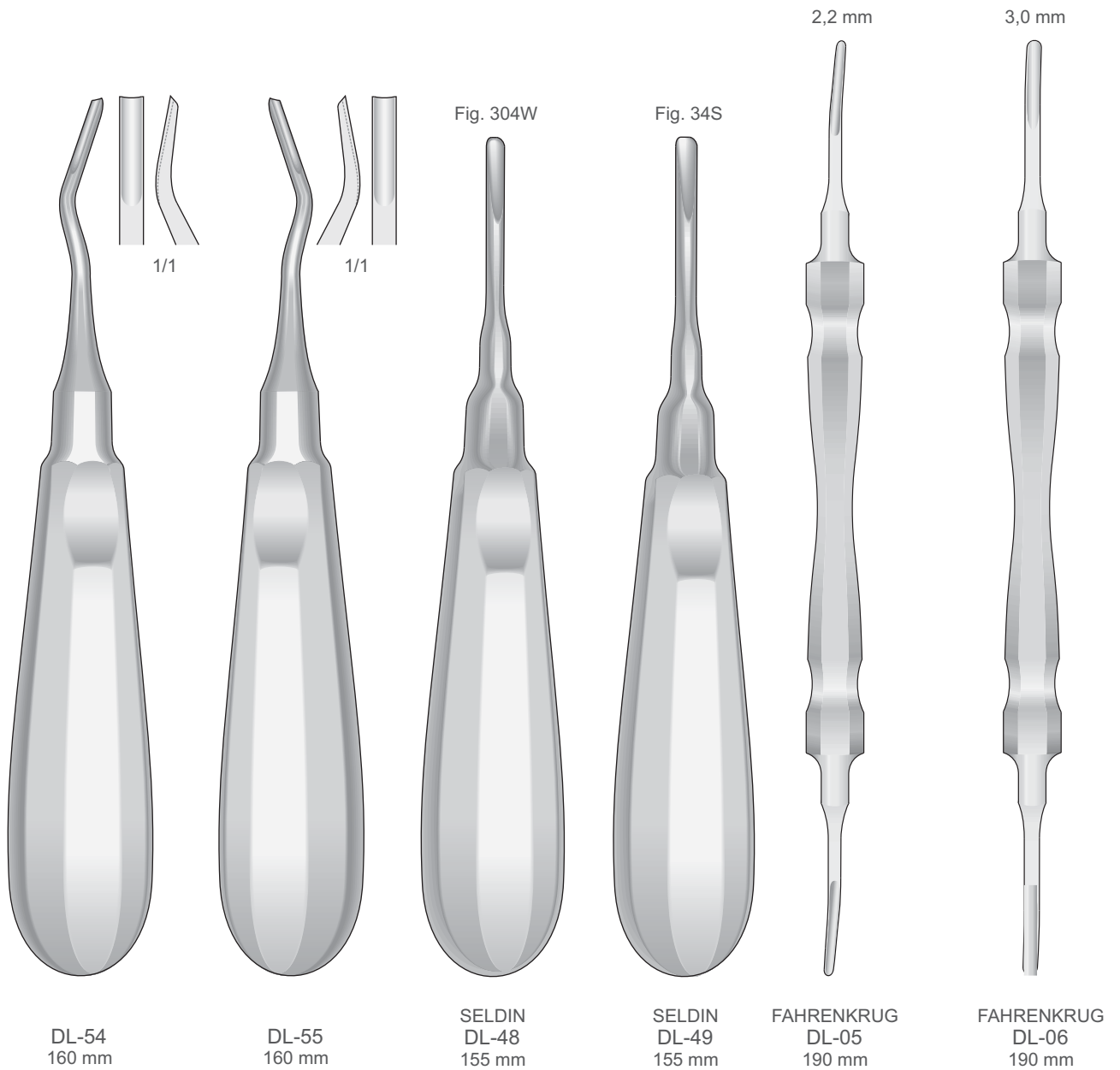
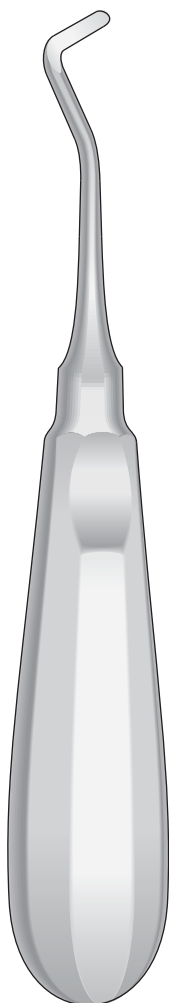
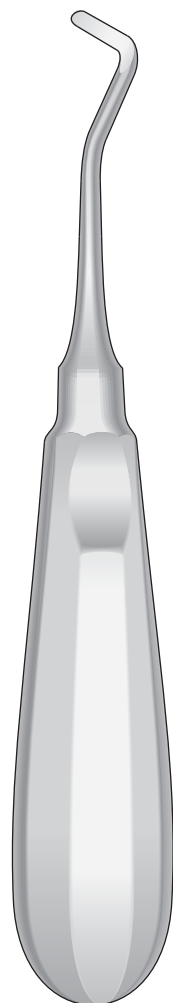

Fig. 6



POTT
DL-98
160 mm

Fig. 7



POTT
DL-99
160 mm

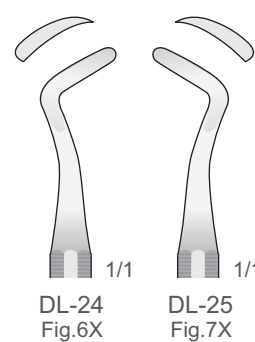

DL-24
Fig.6X
1/1

DL-25
Fig.7X
1/1

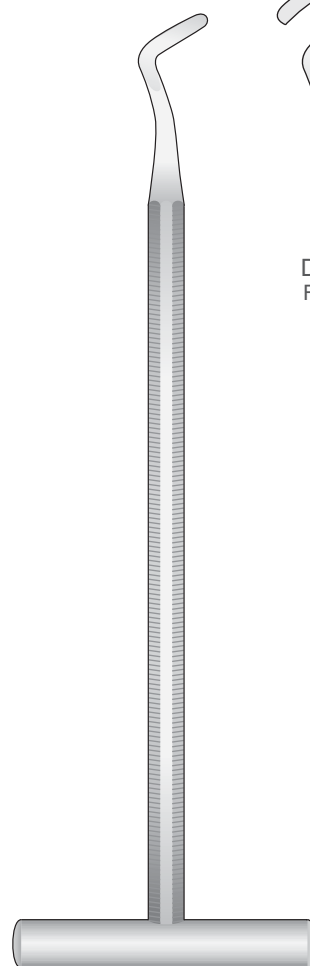

POTT
DL-24/DL-25
155 mm



Wurzelheber
Root Elevators
Leve per radici
Elevadores para raíces
Elevateurs à racines

Syndesmotome
Syndesmotomes
Sindesmotomi
Syndesmôtomos
Syndesmotomes

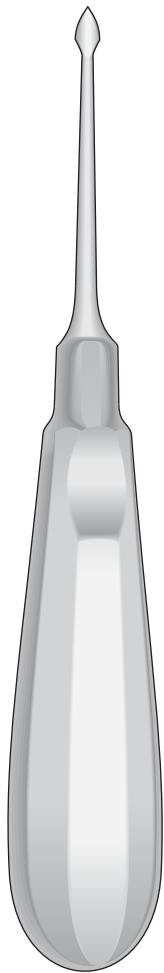

BERNARD
DL-73/DL-124

Gerade
Straight
Diritto
Rectas
Droites



BERNARD
DL-73
150 mm

Links
Left
Sinistra
A la izquierda
À gauche

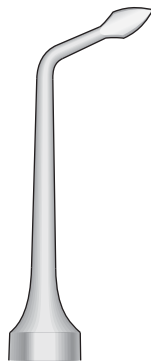

BERNARD
DL-74
140 mm

Rechts
Right
Destro
A la derecha
À droite

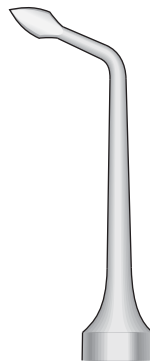

BERNARD
DL-75
140 mm

Bajonett - Bayonet
Baionetta - Bayoneta
Baionnette

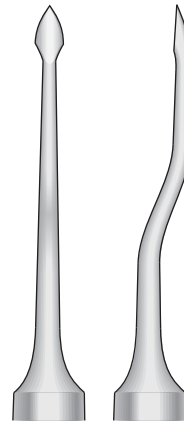

BERNARD
DL-123
150 mm

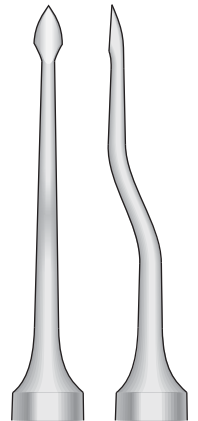

BERNARD
DL-124
150 mm

Wurzelheber
Root Elevators
Leve per radici
Elevadores para raíces
Elevateurs à racines

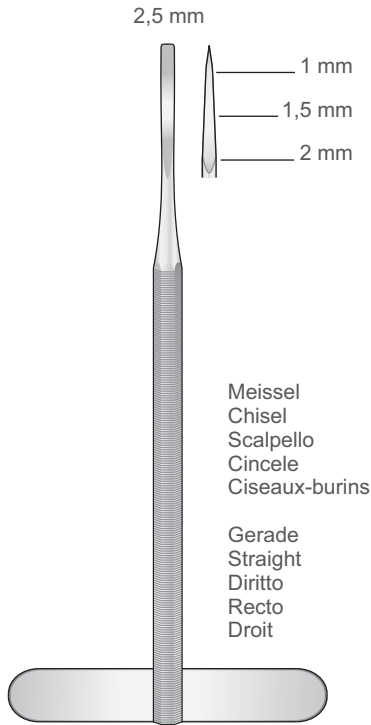

DL-88
130 mm

Meissel
Chisel
Scalpello
Cincele
Ciseaux-burins

Gerade
Straight
Diritto
Recto
Droit

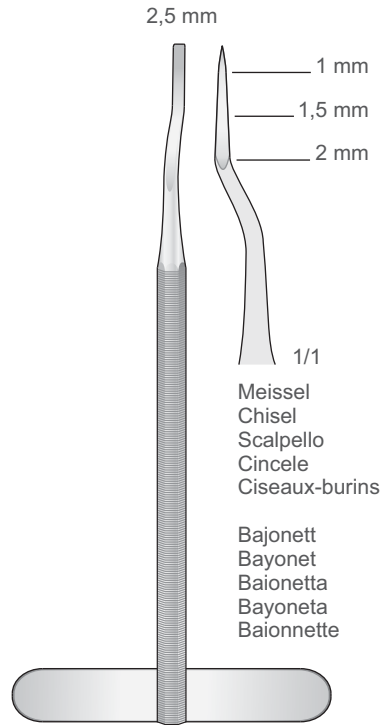

DL-89
130 mm

Meissel
Chisel
Scalpello
Cincele
Ciseaux-burins

Bajonett
Bayonet
Baionetta
Bayoneta
Baionnette

Syndesmotome
Syndesmotomes
Sindesmotomo
Syndesmõtomos
Syndesmotomes



DL-63

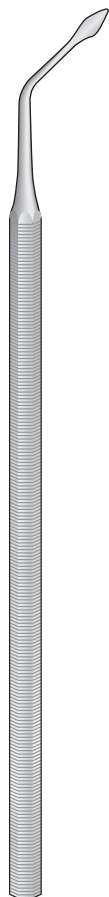

DL-62

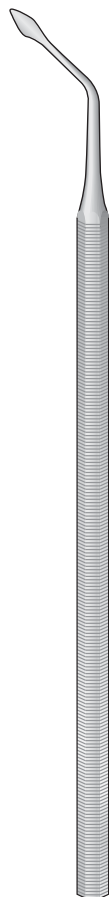

DL-61

Raspatorien
Raspatories
Scollaperiosteo
Legras
Rugines



DL-59

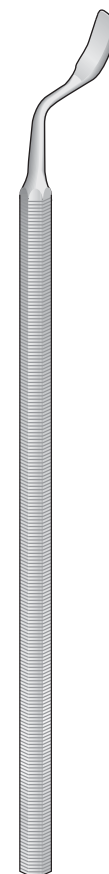

DL-68

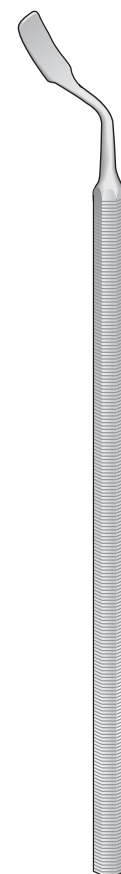

DL-69



Wurzelheber
Root Elevators
Leve per radici
Elevadores para raíces
Elevateurs à racines

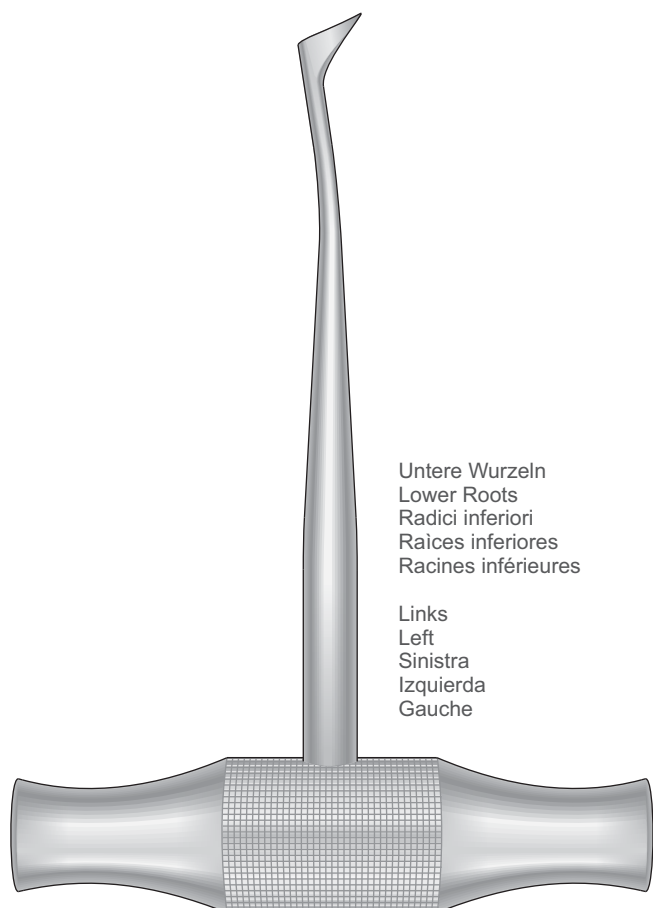

Untere Wurzeln
Lower Roots
Radici inferiori
Raíces inferiores
Racines inférieures

Links
Left
Sinistra
Izquierda
Gauche

WINTER
DL-100
Fig.1

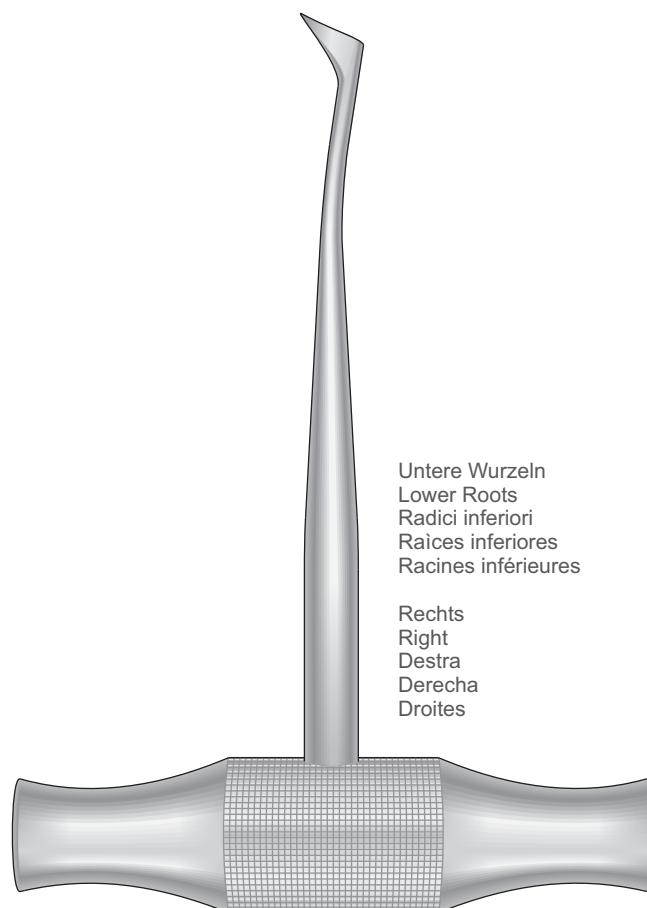

Untere Wurzeln
Lower Roots
Radici inferiori
Raíces inferiores
Racines inférieures

Rechts
Right
Dextra
Derecha
Droites

WINTER
DL-101
Fig.2

Fig. 1L



WINTER
DL-64
120 mm

Fig. 1R

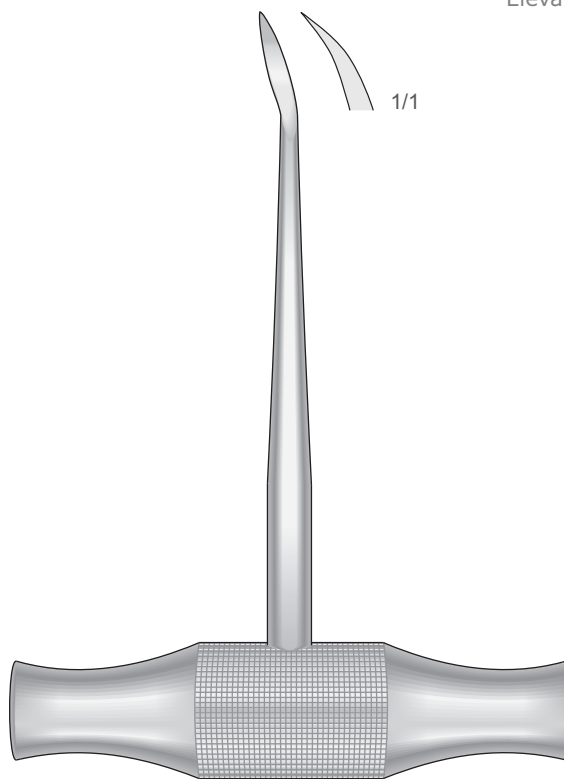

WINTER
DL-65
120 mm

Fig. 14L



WINTER
DL-66
125 mm

Fig. 14R



WINTER
DL-67
125 mm



Wurzelheber
Root Elevators
Leve per radici
Elevadores para raíces
Elevateurs à racines

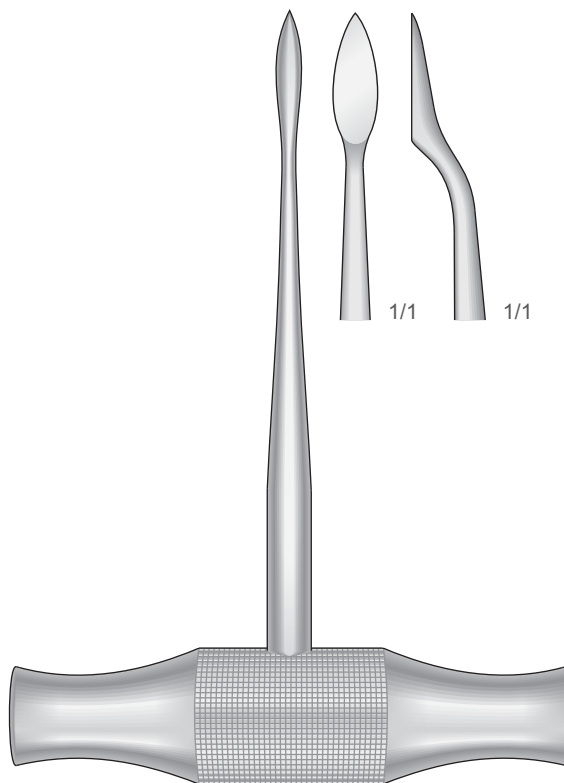

LECLUSE
DL-90
130 mm

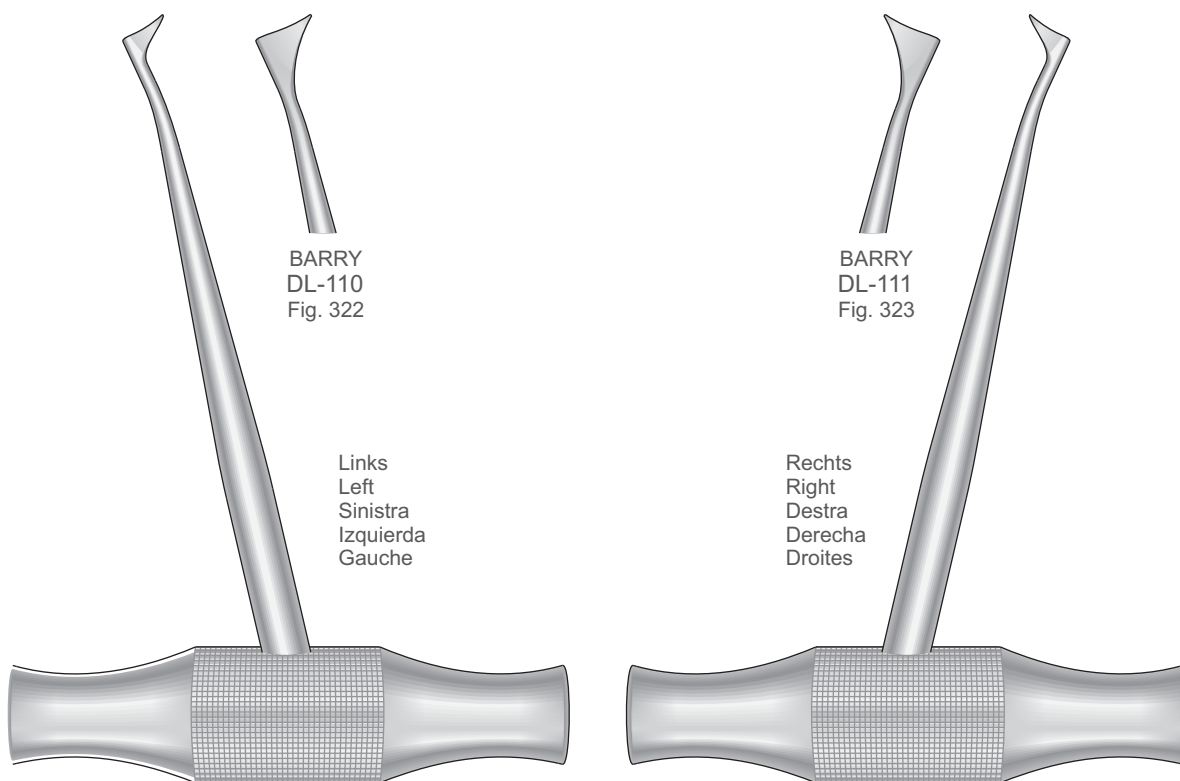
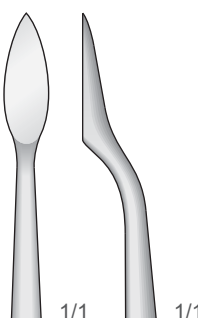

BARRY
DL-110
Fig. 322

BARRY
DL-111
Fig. 323

Links
Left
Sinistra
Izquierda
Gauche

Rechts
Right
Destra
Derecha
Droites

BARRY
DL-108 Fig. 320
115 mm

BARRY
DL-109 Fig. 321
115 mm

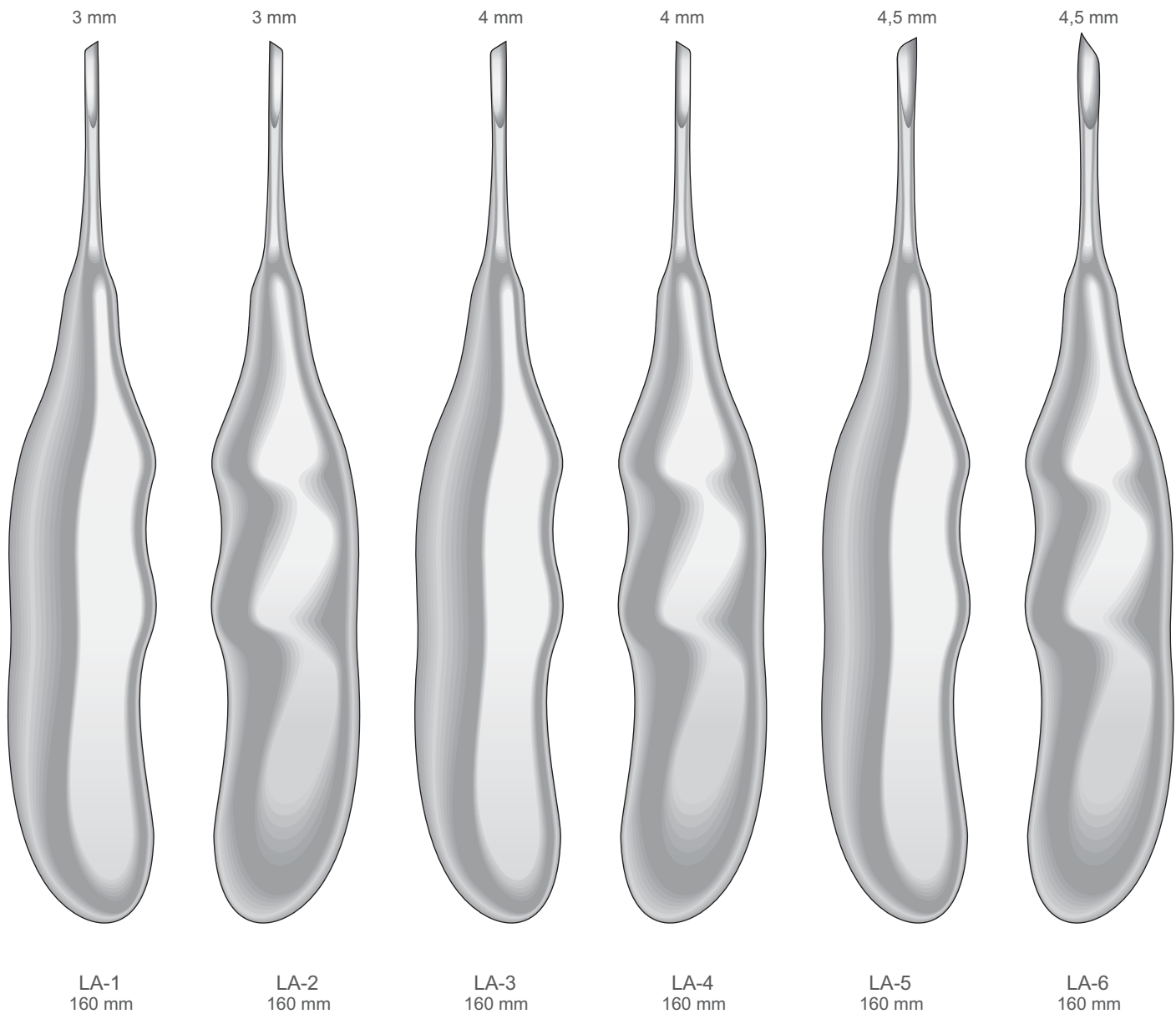



Wurzelheber
Root Elevators
Leve per radici
Elevadores para raíces
Elevateurs à racines

02



LA-7
160 mm



LA-8
160 mm



LA-9
160 mm



LA-10
160 mm

2 mm



LA-11
155 mm

3 mm



LA-12
155 mm

4 mm



LA-13
155 mm



LA-16
160 mm



LA-17
160 mm



Wurzelheber
Root Elevators
Leve per radici
Elevadores para raíces
Elevateurs à racines

02



LA-20
160 mm



LA-21
160 mm



LA-22
160 mm



LA-23
160 mm

Syndesmotome
Syndesmotomes
Sindesmotomo
Syndesmôtomos
Syndesmotomes



Massiv
Solid
Manico
Pieno
Massif

CHOMPRET
CH-11
150 mm



Massiv
Solid
Manico
Pieno
Massif

CHOMPRET
CH-12
150 mm



Massiv
Solid
Manico
Pieno
Massif

CHOMPRET
CH-13
150 mm



Massiv
Solid
Manico
Pieno
Massif

CHOMPRET
CH-14
145 mm

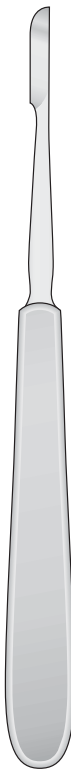

CHOMPRET
CH-1
165 mm



CHOMPRET
CH-2
165 mm



CHOMPRET
CH-3
165 mm



CHOMPRET
CH-4
160 mm



Zahnreiniger - Periotome
 Scalers - Periotomes
 Ablatori di tartaro - Periotomi
 Limpiadores de sarro - Periotomos
 Detarteurs - Périotomes

MORSE - SCALERS

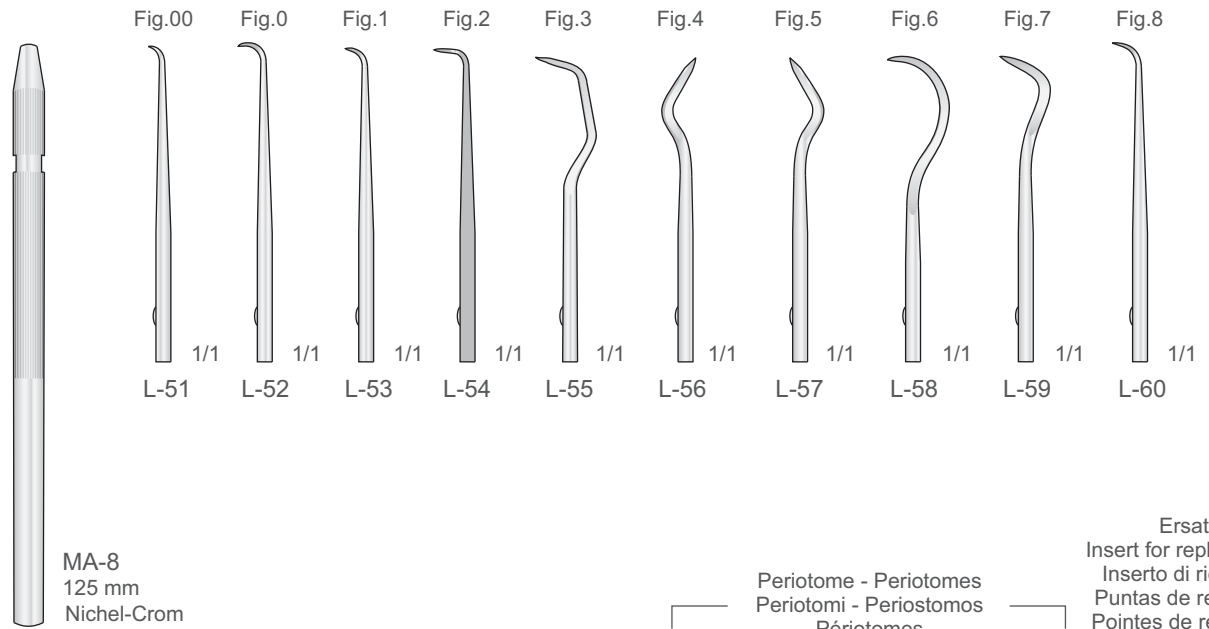

Ersatz
 Insert for replacement
 Inserto di ricambio
 Puntas de recambio
 Pointes de rechange

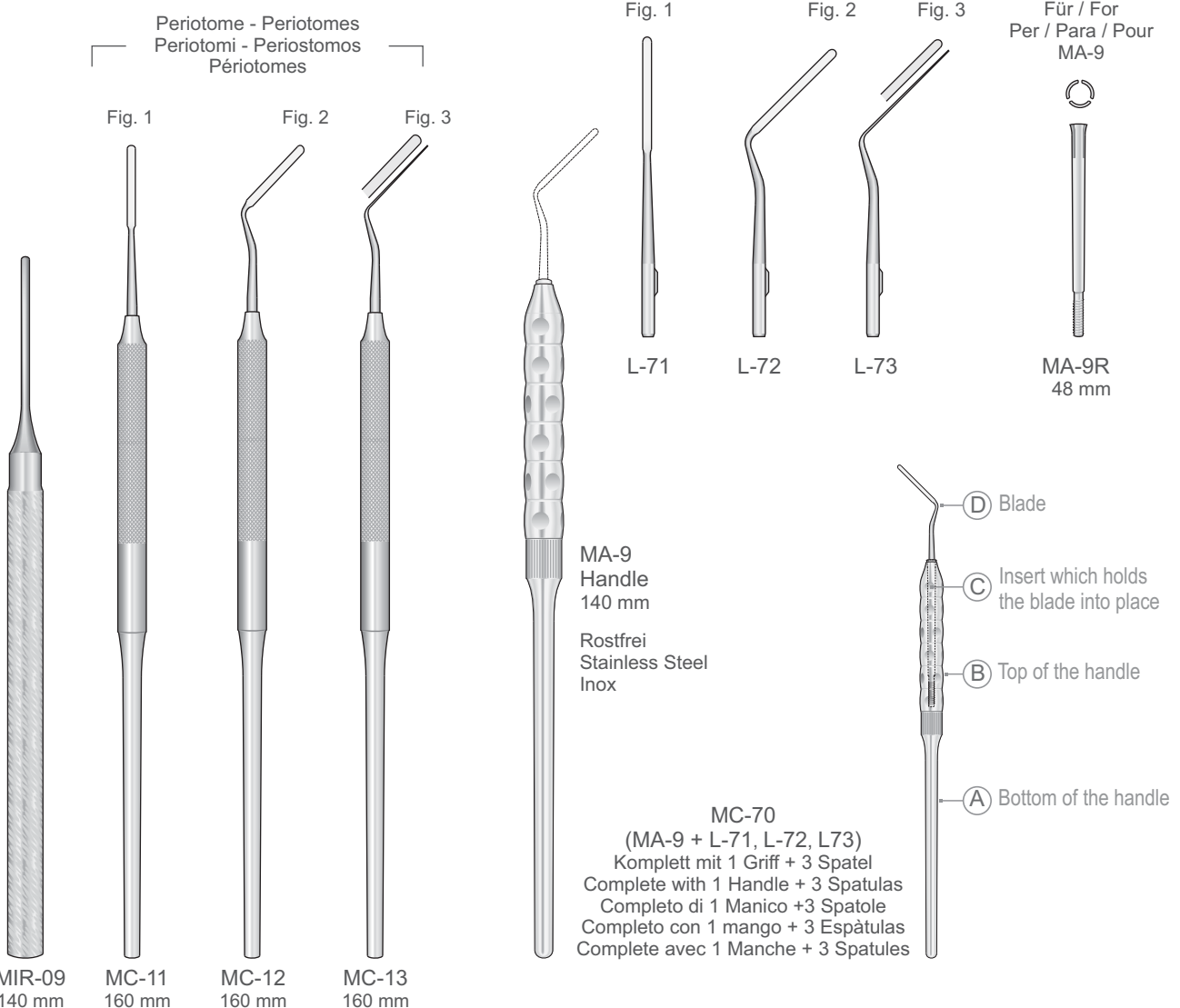

SDM-C
Komplett mit 2 Griffe + 20 Klingen
Complete with 2 Handles + 20 Blades
Completo di 2 Manici + 20 lame
Completo con 2 mangos + 20 hojas
Complete avec 2 Manches + 20 lames

SDM-M
Griff
Handle
Manico
Mango
Manche

SDM-9
Komplett mit 2 Griffe + 9 Klingen APICALI
Complete with 2 Handles + 9 Blades APICALI
Completo di 2 Manici + 9 lame APICALI
Completo con 2 mangos + 9 hojas APICALI
Complete avec 2 Manches + 9 lames APICALI

SDM-11
Komplett mit 2 Griffe + 11 Klingen CERVICALI
Complete with 2 Handles + 11 Blades CERVICALI
Completo di 2 Manici + 11 lame CERVICALI
Completo con 2 mangos + 11 hojas CERVICALI
Complete avec 2 Manches + 11 lames CERVICALI



SD-M

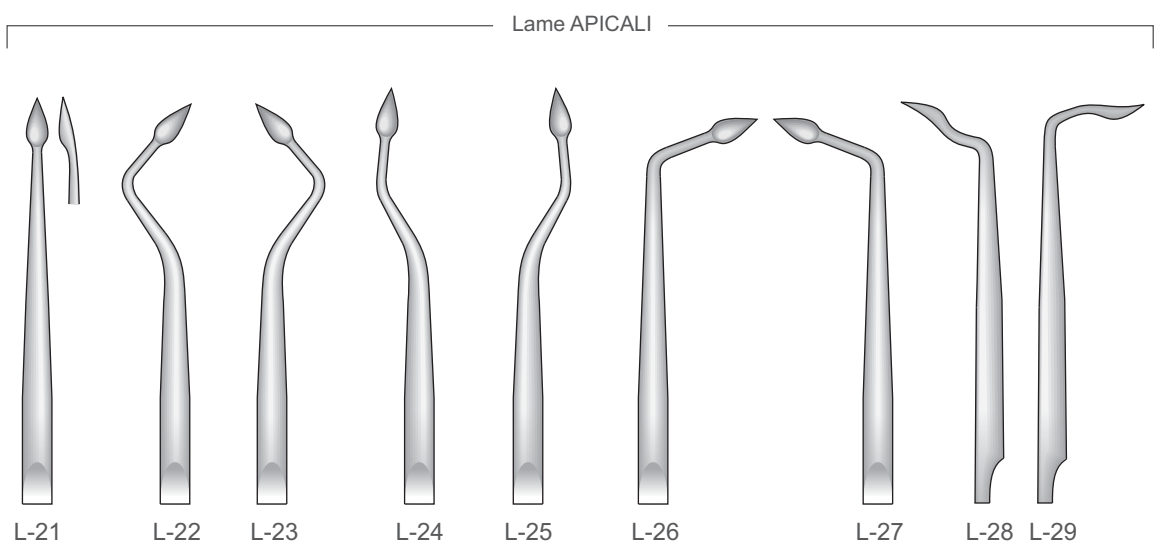
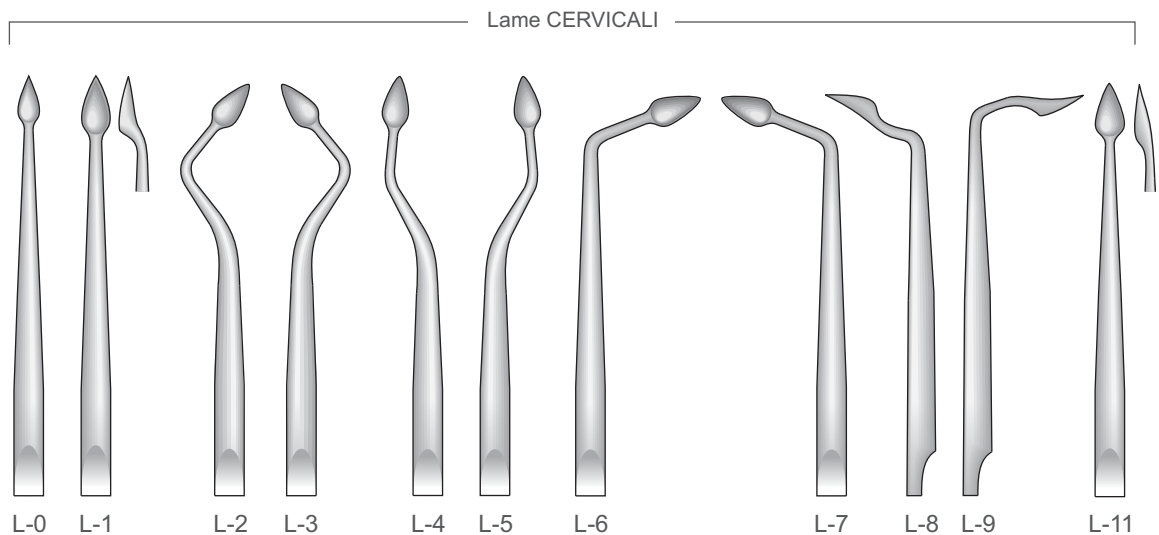



03 |

Scalpel Blades and Handles
Skalpelling and Skalpellgriffe
Lames et manches de bistouri
Hojas y mangos de bisturí
Lame e manici per bisturi



Skalpelligriffe - Mikro Skalpelligklingen
Scalpel Handles - Micro Scalpel Blades
Manici per bisturi - Micro lame per bisturi
Mangos de bisturí - Micro hojas de bisturí
Manches pour bistouris - Micro lames de bistouri

Skalpelligriffe für Mikro-Klingen
Scalpel handles for Micro blades
Manici per micro lame
Mangos de bisturí para micro hojas
Manches de bistouris pour micro lames

Rasierklingen-Brecker und halter
Razor blade breaker and holder
Manico porta lame
Mango para Hojas de afeitar
Porte lames à rasoir

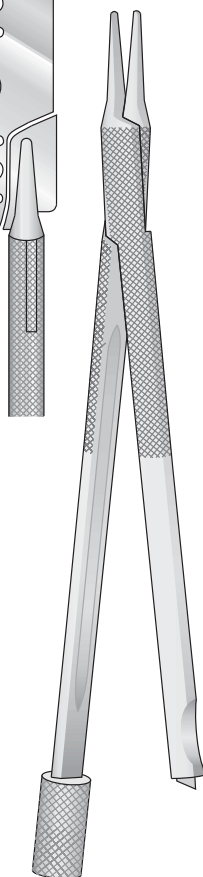
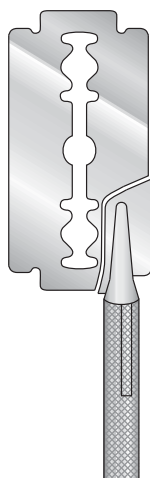

NK-12
120 mm



BB-46
135 mm



BB-48
155 mm

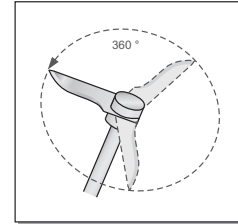

Für Mikro-Klingen
For Micro Blades
Per micro lame
Para micro Hojas
Pour Micro-Lame de bistouris



NK-1
100 mm



NK-3
130 mm



NK-2
150 mm

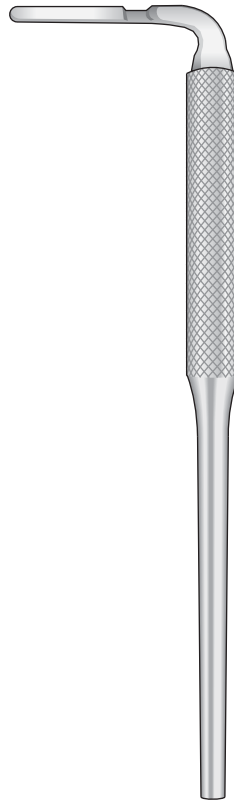

MA-B16
120 mm

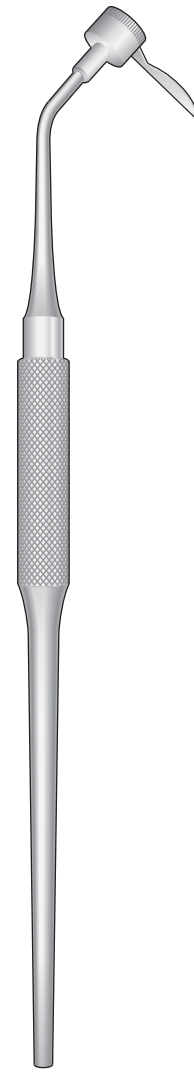

GB-4
165 mm



Skalpelle und Skalpellgriffe
Scalpel Blades and Handle
Lame e manici per bisturi
Hojas y mangos de bisturí
Lames et manches de bistouri

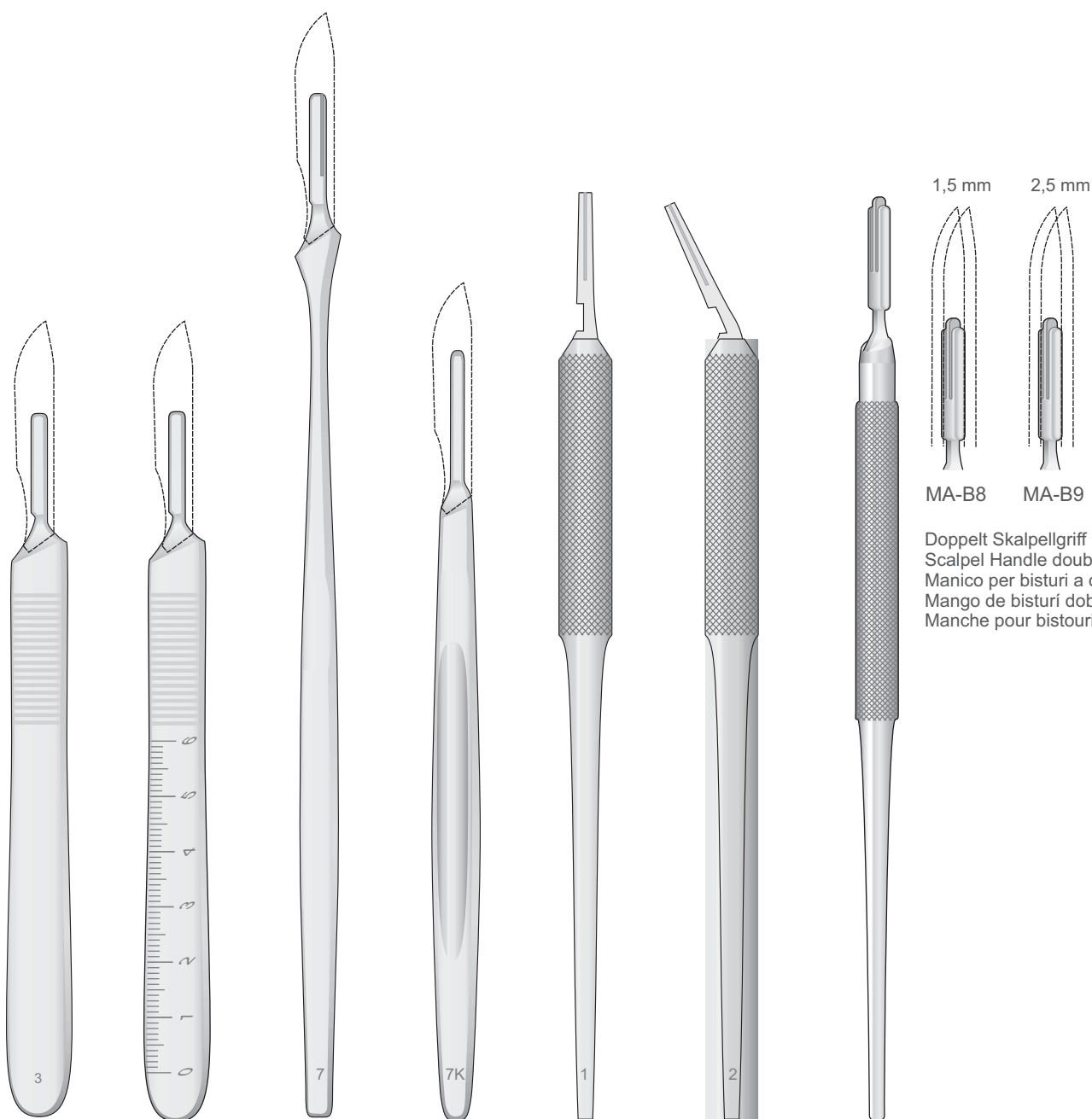

MA-B3

MA-B3M
Fig. 3M

MA-B7

MA-B7K

MA-B1
Fig. 5

MA-B2
Fig. 5A

MA-B8/MA-B9
155 mm

Doppelt Skalpellgriff
Scalpel Handle double Blade
Manico per bisturi a doppia lama
Mango de bisturí doble hojas
Manche pour bistouri double-lames

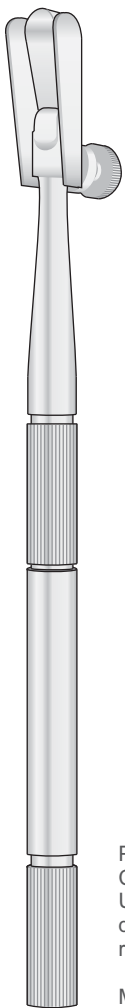

Palatal, Gingival,
Connective Tissue Grafts
Uses standard
double-edged
razor blade

Mucotomo

PAQUETTE
BLADE HOLDER
GB-2
160 mm



MA-B4
Fig. 4

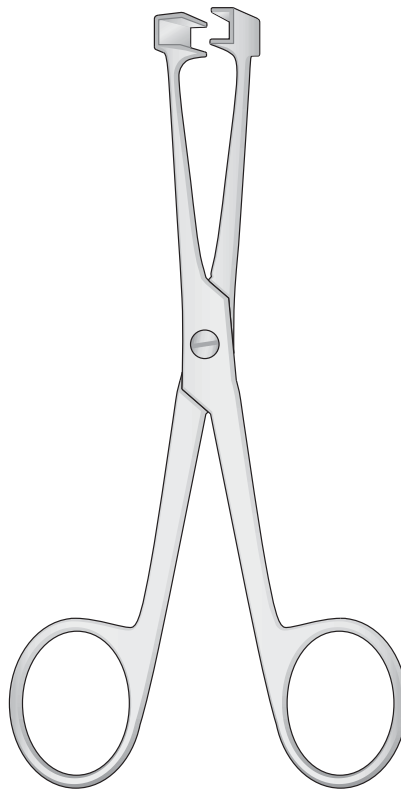

GS-18
135 mm

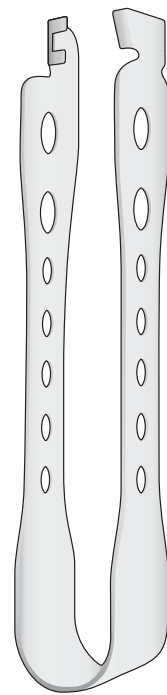

GS-16
115 mm

Klingentfemer
Scalpel blade removing forceps
Pinze togilama
Pinza para quitar hojas de bisturíes
Pince pour enlever les lames de bistouris



Messer
Knives
Coltelli
Cuchillos
Couteaux

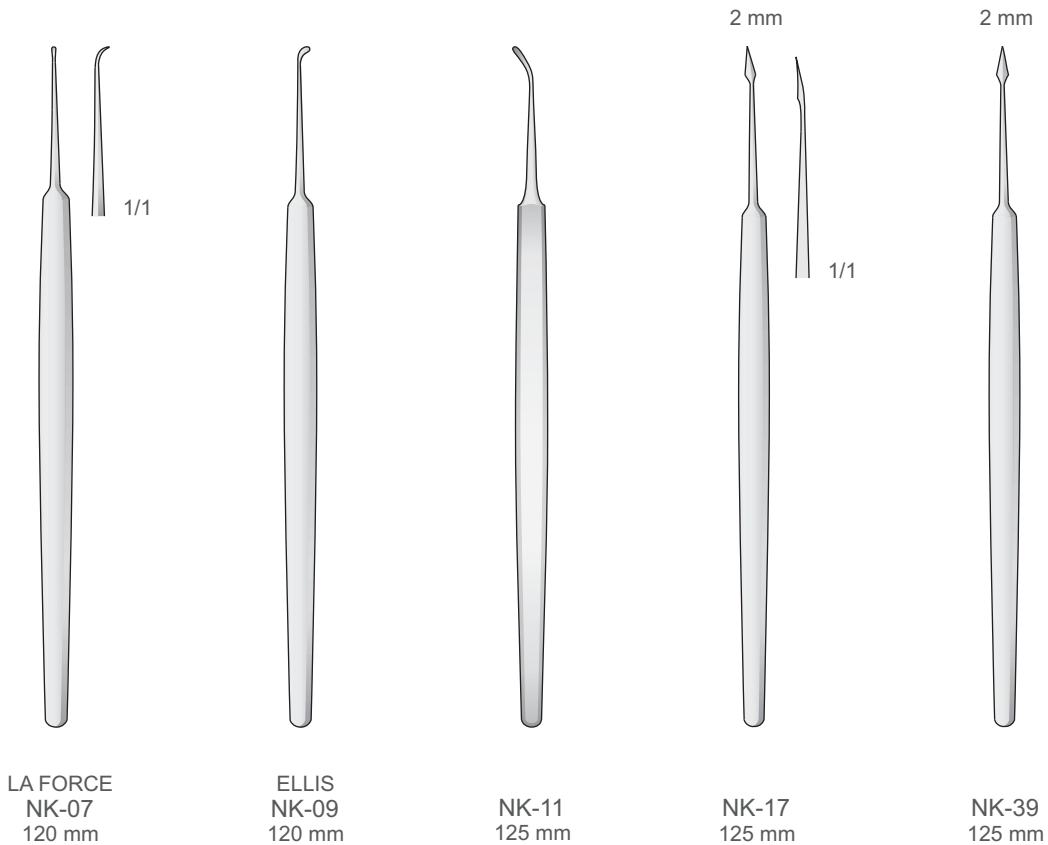
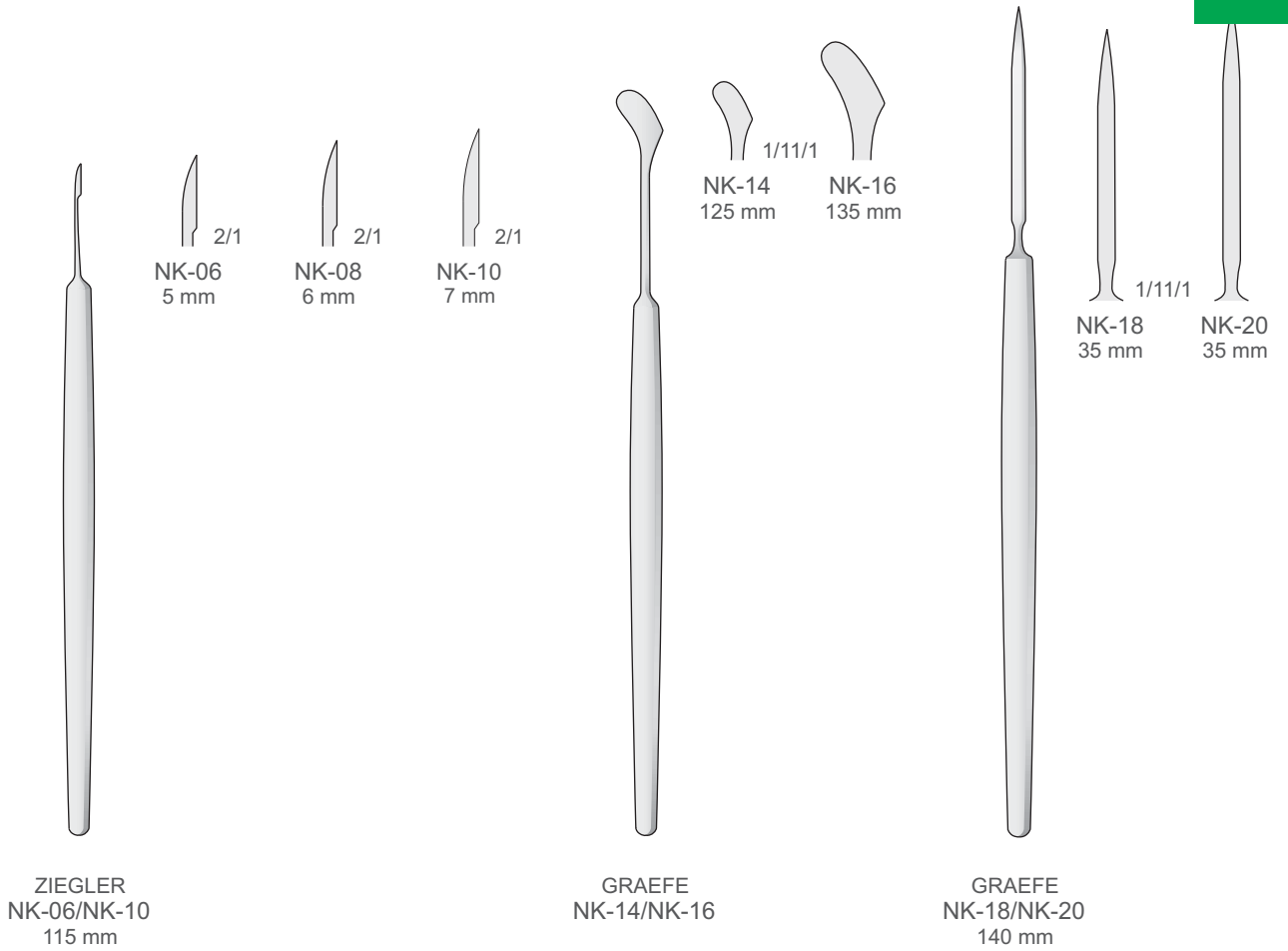



NK-30/NK-40

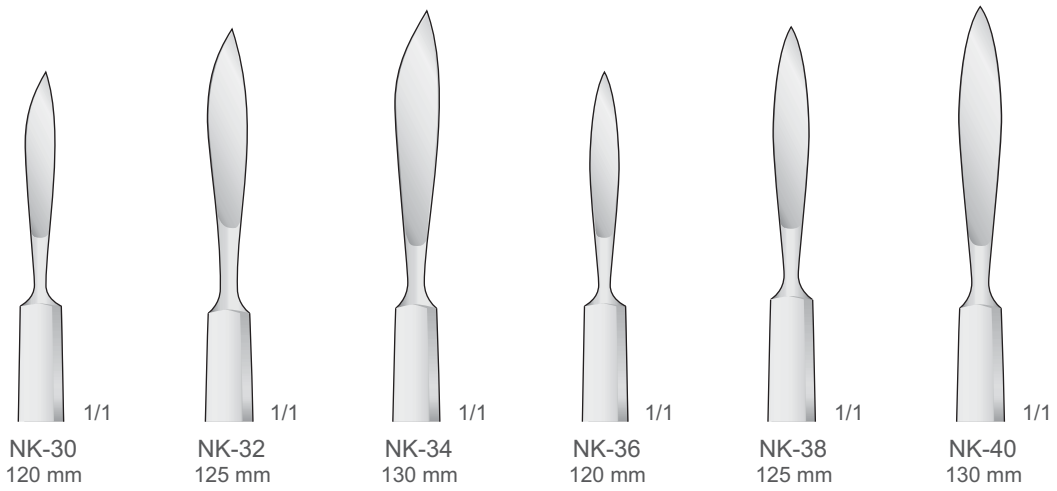

NK-30
120 mm

NK-32
125 mm

NK-34
130 mm

NK-36
120 mm

NK-38
125 mm

NK-40
130 mm

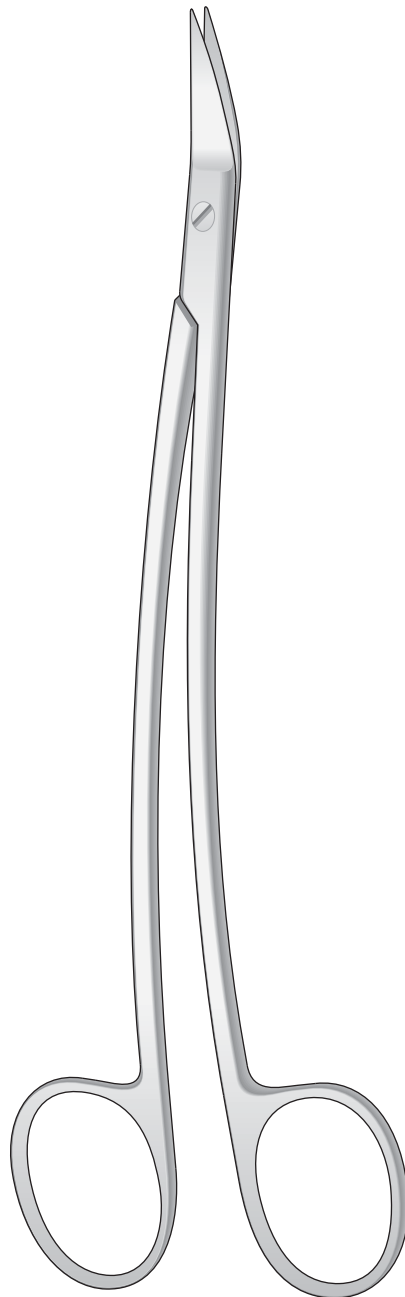

04

Surgical Scissors
Chirurgische Scheren
Ciseaux chirurgicaux
Tijeras quirúrgicas
Forbici Chirurgiche



Mikro-Scheren
Micro Scissors
Micro Forbici
Micro Tijeras
Micro Ciseaux

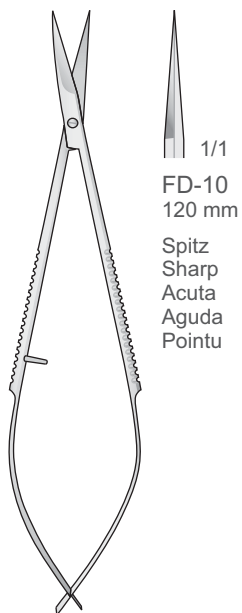

1/1
FD-10
120 mm
Spitz
Sharp
Acuta
Aguda
Pointu

NOYES
FD-10
120 mm

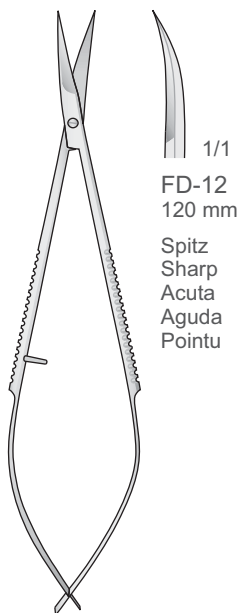

1/1
FD-12
120 mm
Spitz
Sharp
Acuta
Aguda
Pointu

NOYES
FD-12
120 mm

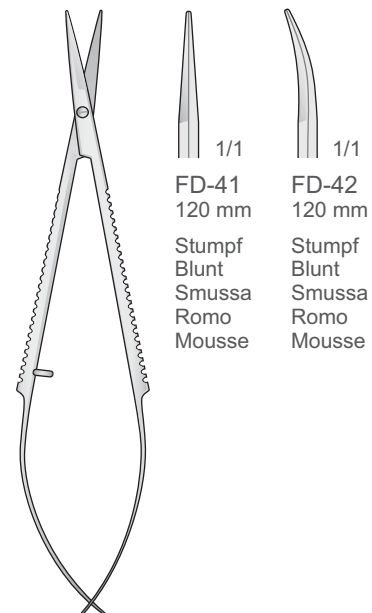

1/1 1/1
FD-41 FD-42
120 mm 120 mm
Stumpf
Blunt
Smussa
Romo
Mousse

FD-41/FD-42
120 mm

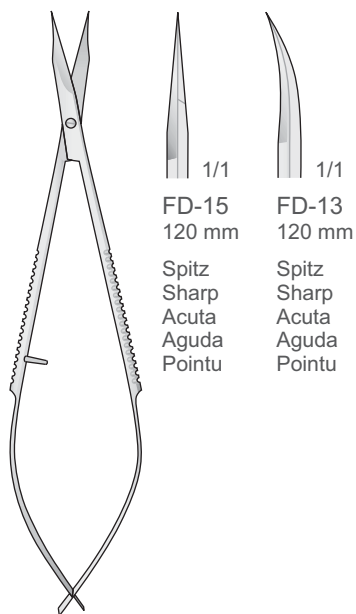

1/1 1/1
FD-15 FD-13
120 mm 120 mm
Spitz
Sharp
Acuta
Aguda
Pointu

WESTCOTT
FD-13/FD-15
120 mm

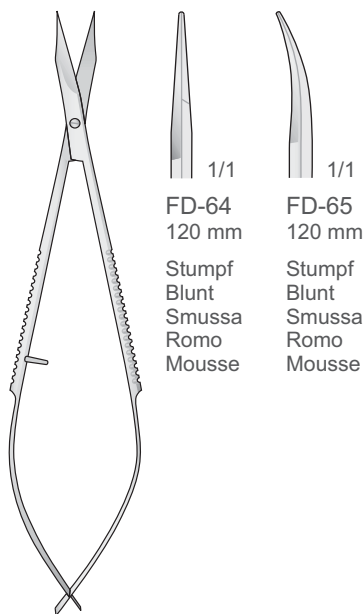

1/1 1/1
FD-64 FD-65
120 mm 120 mm
Stumpf
Blunt
Smussa
Romo
Mousse

WESTCOTT
FD-64/FD-65
120 mm

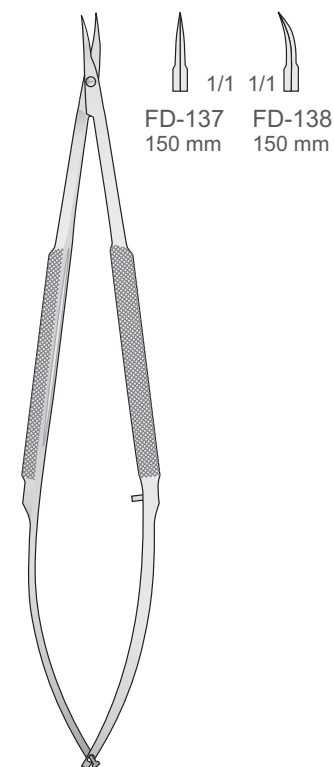

1/1 1/1
FD-137 FD-138
150 mm 150 mm

FD-137/FD-138
150 mm

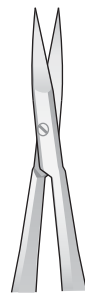
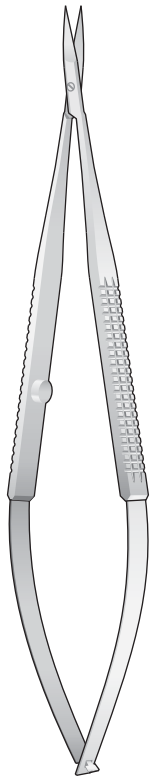

FD-182
160 mm
Spitz
Sharp
Acuta
Aguda
Pointu

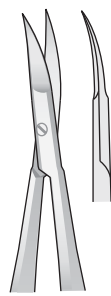

FD-183
160 mm
Spitz
Sharp
Acuta
Aguda
Pointu

1/1

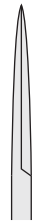
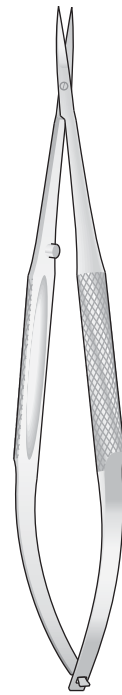

FD-224
145 mm
Spitz
Sharp
Acuta
Aguda
Pointu



FD-225
145 mm
Spitz
Sharp
Acuta
Aguda
Pointu

1/1

1/1

FD-182/FD-183
160 mm

FD-224/FD-225
145 mm

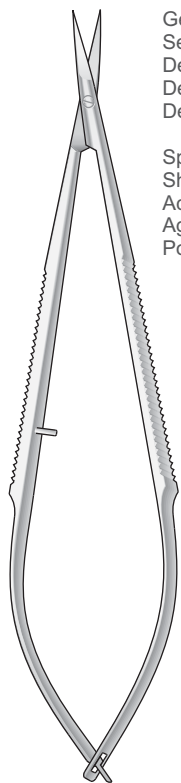

Gezahnt
Serrated
Dentellata
Dentada
Dentelé

Spitz
Sharp
Acuta
Aguda
Pointu

FD-145
160 mm

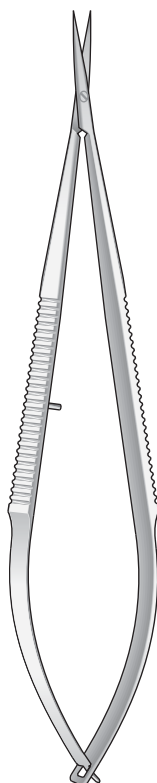

FD-06
160 mm
Spitz
Sharp
Acuta
Aguda
Pointu

1/1

FD-06
160 mm

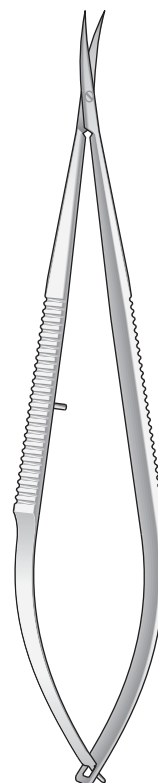

FD-08
160 mm
Spitz
Sharp
Acuta
Aguda
Pointu

1/1

FD-08
160 mm



Scheren
Scissors
Forbici
Tijeras
Ciseaux

Spitz - Sharp
Acuta - Aguda
Pointu

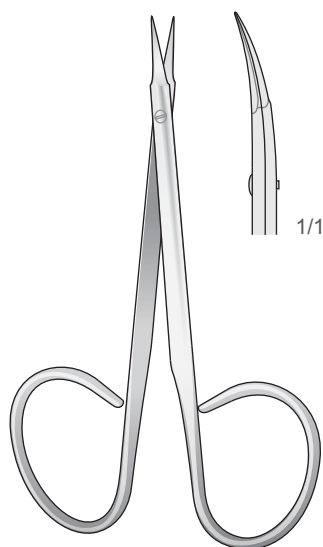

STITCH
FG-216
115 mm

Iris Scheren - Iris scissors
Forbici Iris - Tijeras Iris
Ciseaux Iris

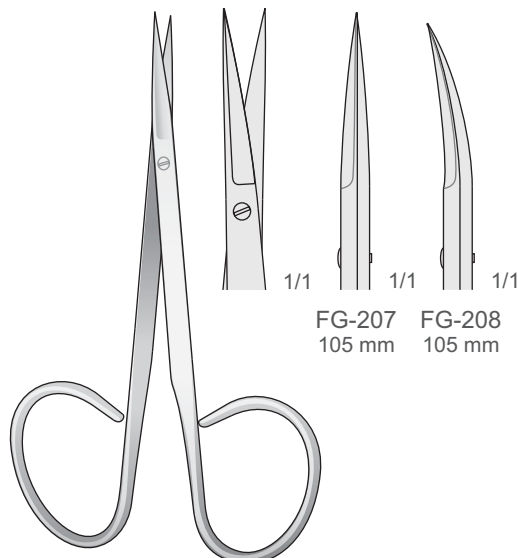

FG-207/FG-208
105 mm

FG-207 105 mm
FG-208 105 mm

Stumpf - Blunt
Smussa - Romas
Mousse

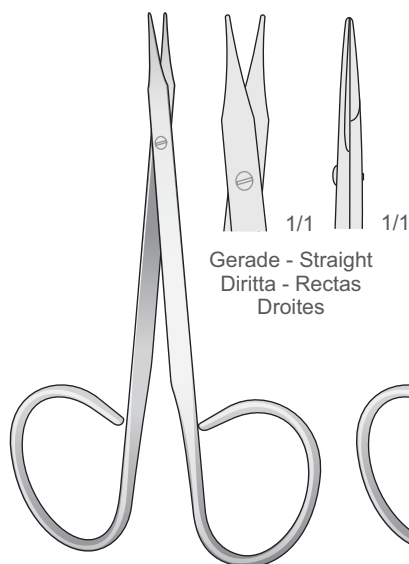

STEVENS
FG-209
100 mm

Stumpf - Blunt
Smussa - Romas
Mousse

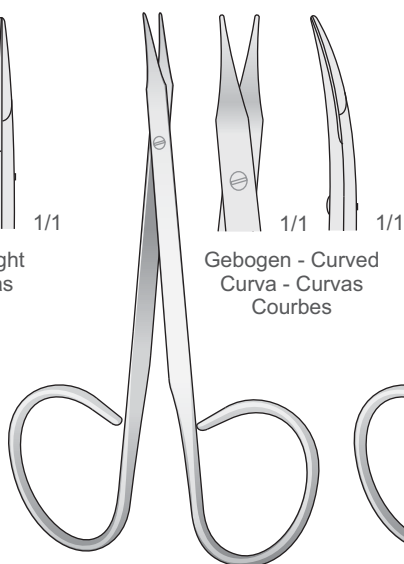

STEVENS
FG-210
100 mm

Spitz - Sharp
Acuta - Aguda
Pointu

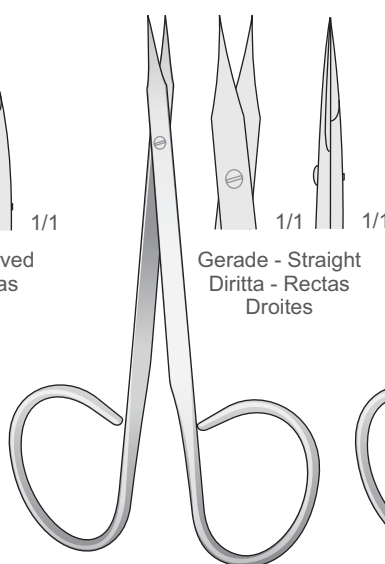

WALTON
FG-211
100 mm

Spitz - Sharp
Acuta - Aguda
Pointu

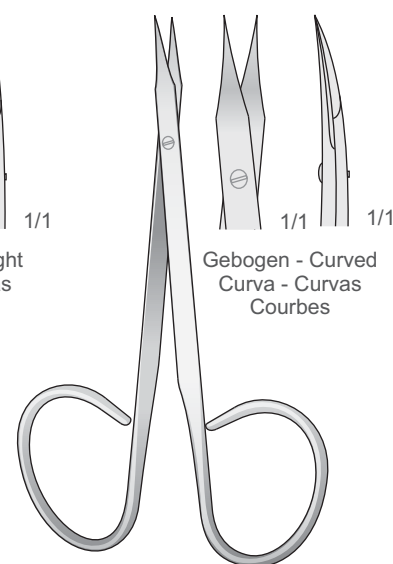

WALTON
FG-212
100 mm

Gerade - Straight
Diritta - Rectas
Droites

Gebogen - Curved
Curva - Curvas
Courbes

Gerade - Straight
Diritta - Rectas
Droites

Gebogen - Curved
Curva - Curvas
Courbes

04

Scheren
Scissors
Forbici
Tijeras
Ciseaux

L = links
left
mancini
izquierdo
gauche

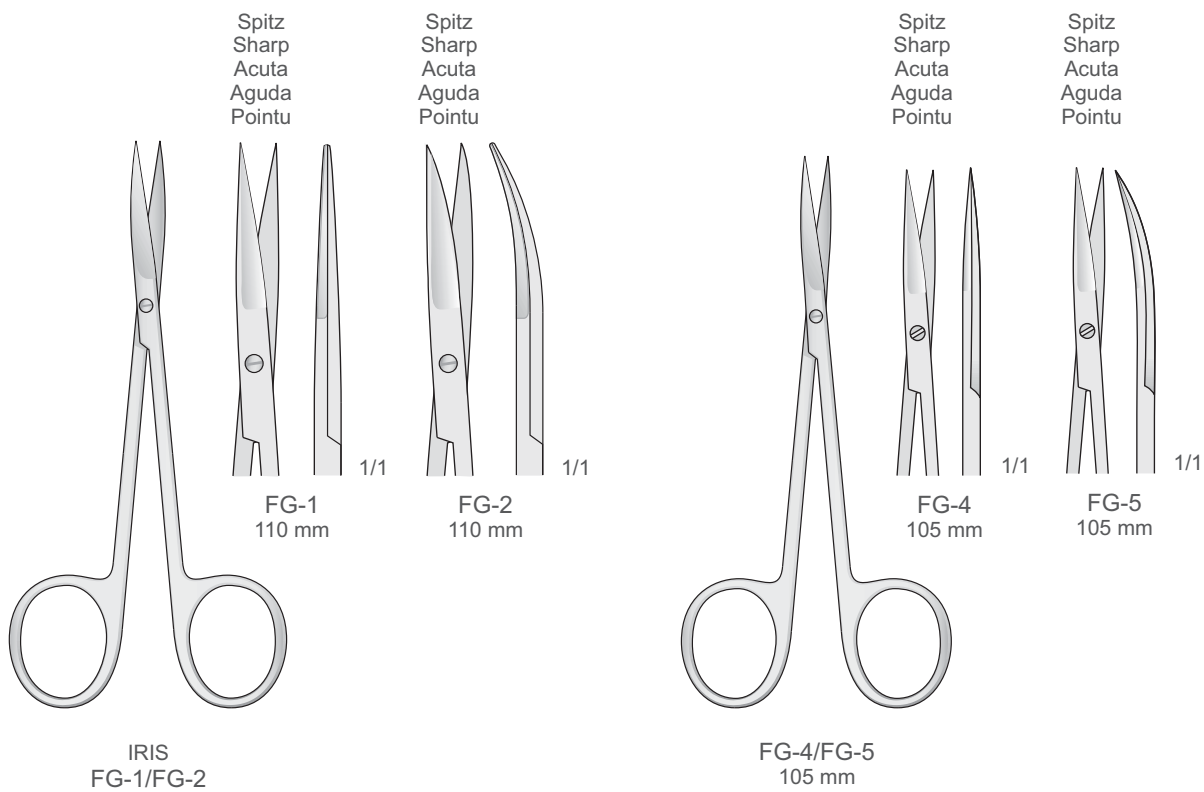
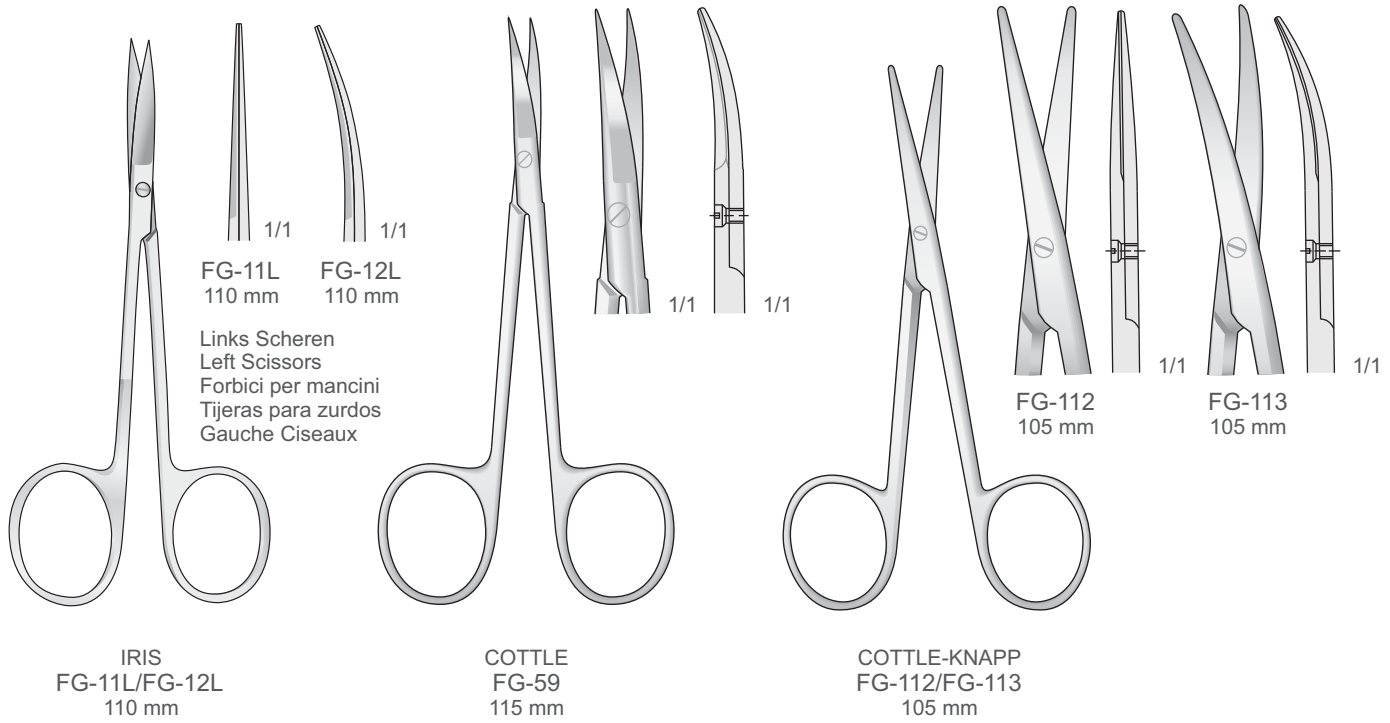



Scheren
Scissors
Forbici
Tijeras
Ciseaux

04

Gezahnt - Serrated
Dentellata - Dentelé - Dentadas

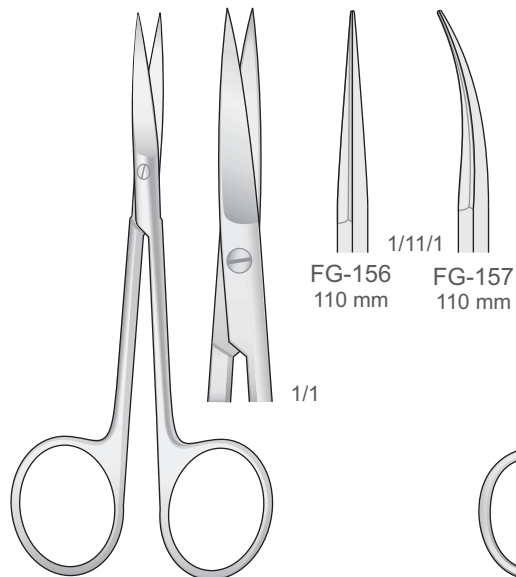

FG-156/FG-157
110 mm

Gezahnt - Serrated
Dentellata - Dentelé - Dentadas

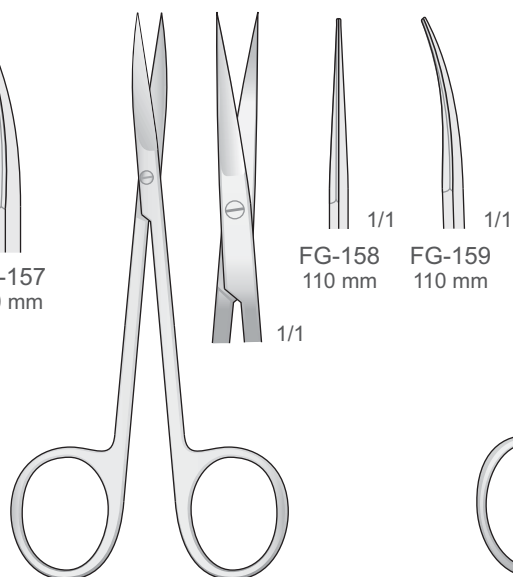

FG-158/FG-159
110 mm

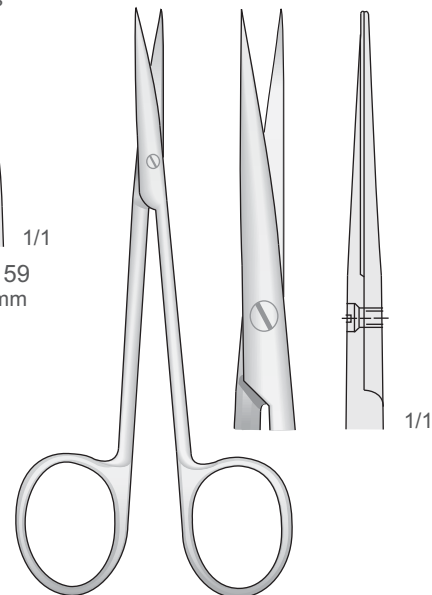

KILNER
FG-58
115 mm

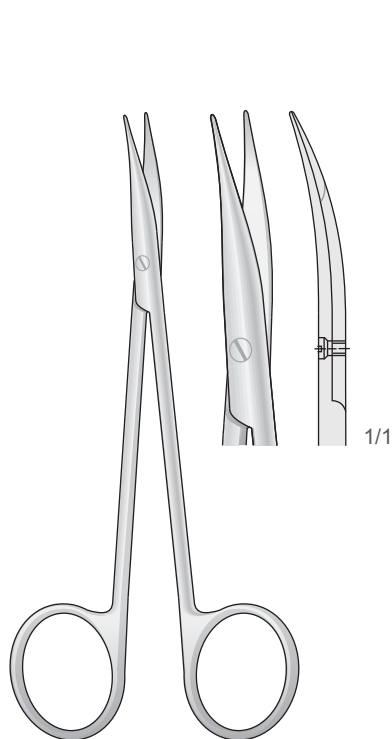

JAMESON-WERBER
FG-123
130 mm

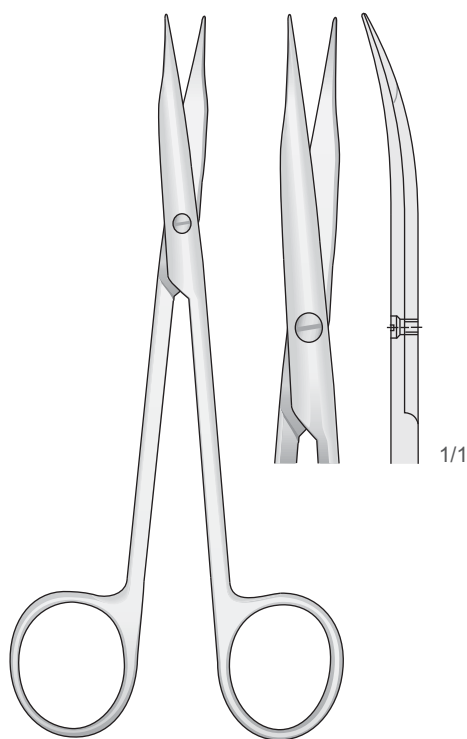

JAMESON
FG-124
145 mm

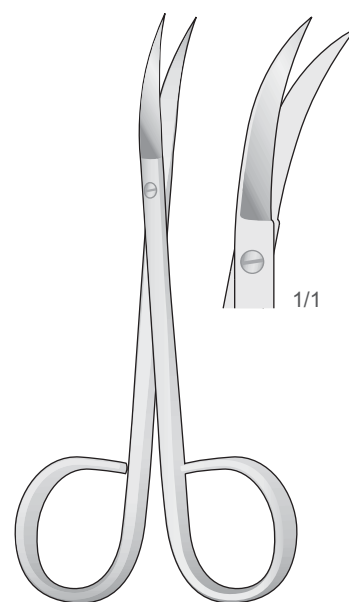

FG-3
115 mm

Spitz
Sharp
Acuta
Aguda
Pointu

Spitz
Sharp
Acuta
Aguda
Pointu

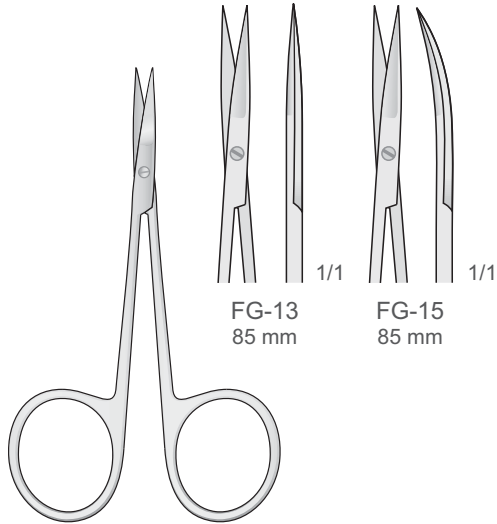

FG-13
85 mm

FG-15
85 mm

MICRO-IRIS
FG-13/FG-15
85 mm

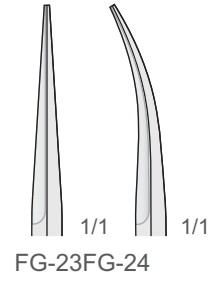

FG-23 FG-24

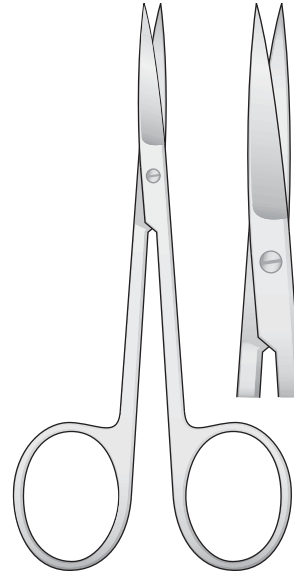

FG-23/FG-24
110 mm

Extra flach
Extra flat
Estremamente piatta
Extra plano
Extrêmement plat

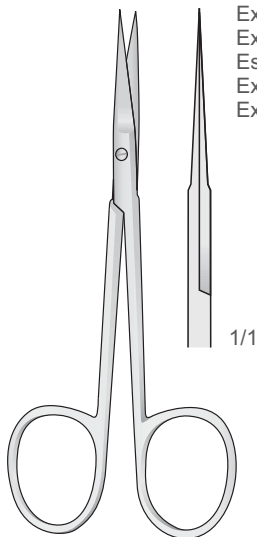

FG-104
100 mm

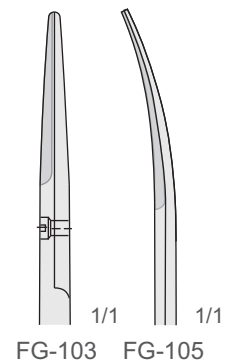

FG-103 FG-105

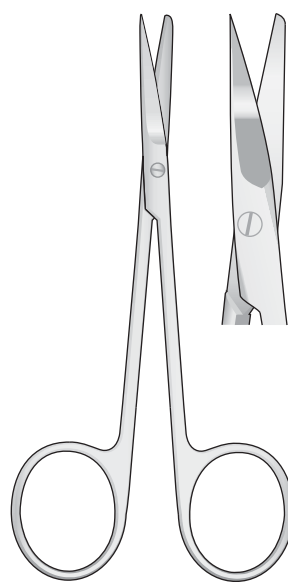

FG-103/FG-105
110 mm



Scheren
Scissors
Forbici
Tijeras
Ciseaux

Spitz - Sharp
Acuta - Agudo
Aigu

Spitz - Sharp
Acuta - Agudo
Aigu

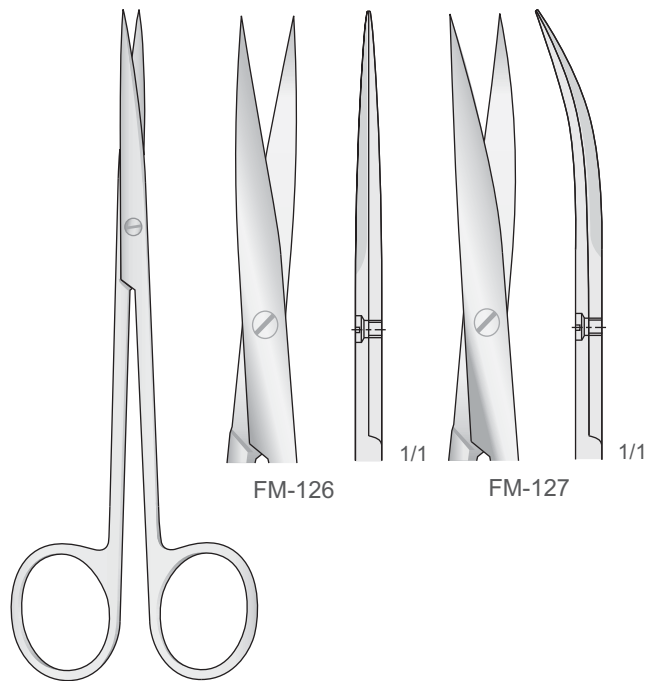

FM-126

FM-127

METZENBAUM
FM-126/FM-127
145 mm

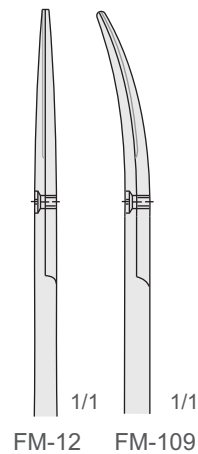

FM-12

FM-109

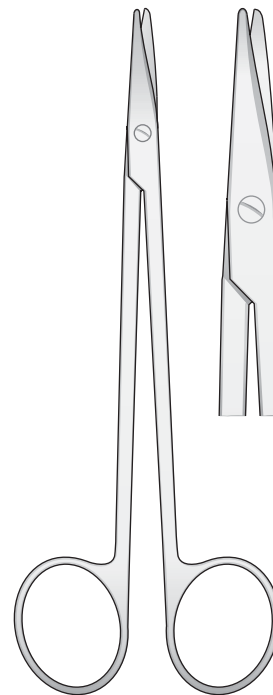

METZENBAUM
FM-12/FM-109
150 mm

1/1
Spitz
Sharp
Acuta
Aguda
Pointu

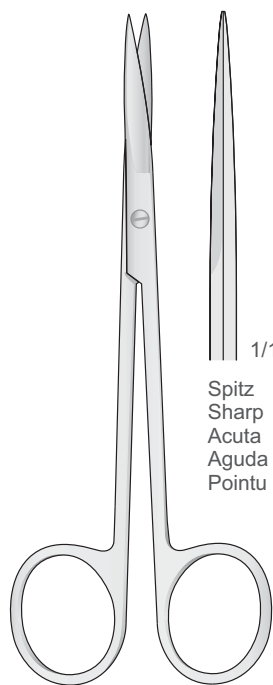

METZENBAUM
FG-28
145 mm

1/1
Spitz
Sharp
Acuta
Aguda
Pointu

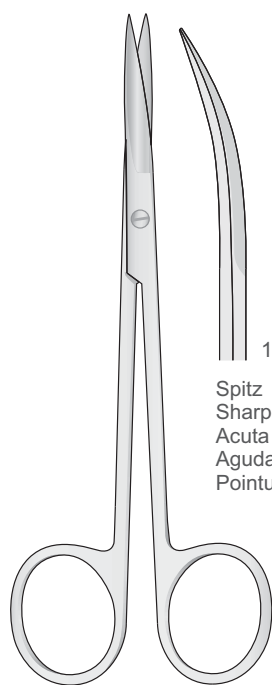

METZENBAUM
FG-14
145 mm

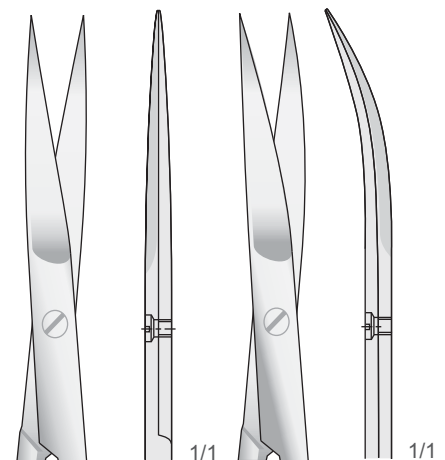

FG-147
150 mm

FG-148
150 mm

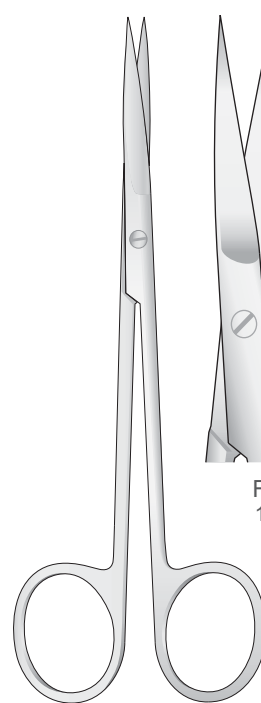

JOSEPH
FG-147/FG-148
150 mm

Stumpf
Blunt
Smussa
Romas
Mousse

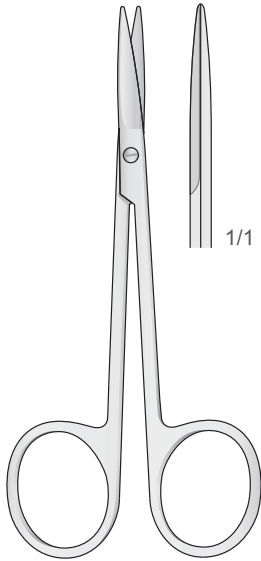

FG-101
110 mm

Stumpf
Blunt
Smussa
Romas
Mousse

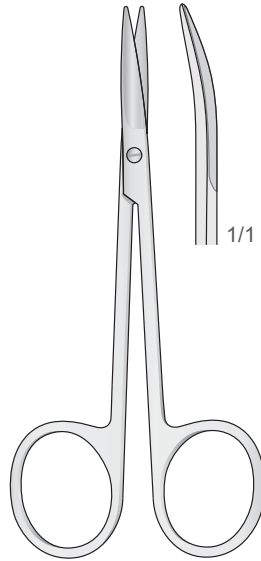

FG-102
110 mm

Stumpf
Blunt
Smussa
Romas
Mousse

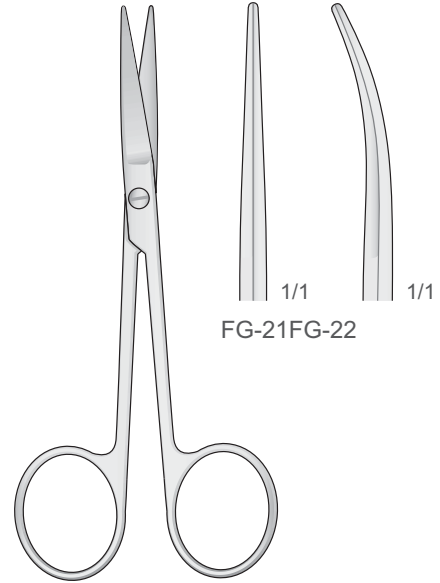

FG-21/FG-22
115 mm

Spitz
Sharp
Acute
Agudas
Pointu

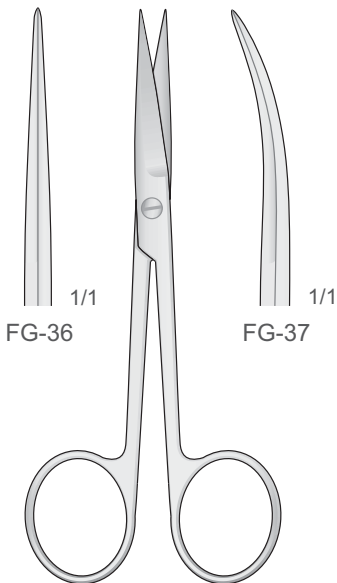

FG-36/FG-37
115 mm

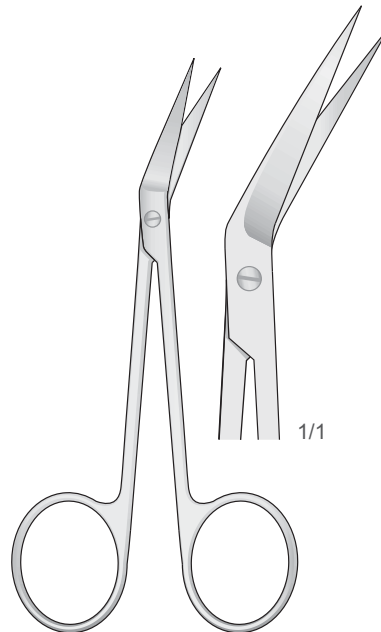

LOCKLIN
LK-1
115 mm

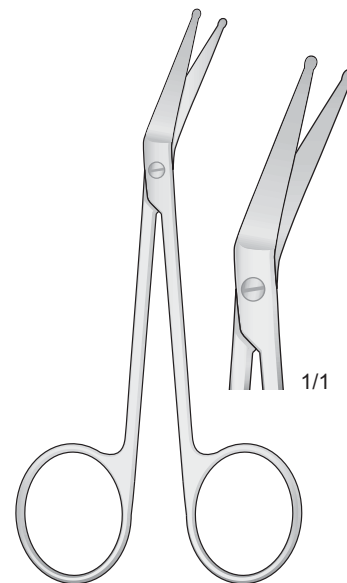

LOCKLIN MOD.
LK-3
110 mm



Scheren
Scissors
Forbici
Tijeras
Ciseaux

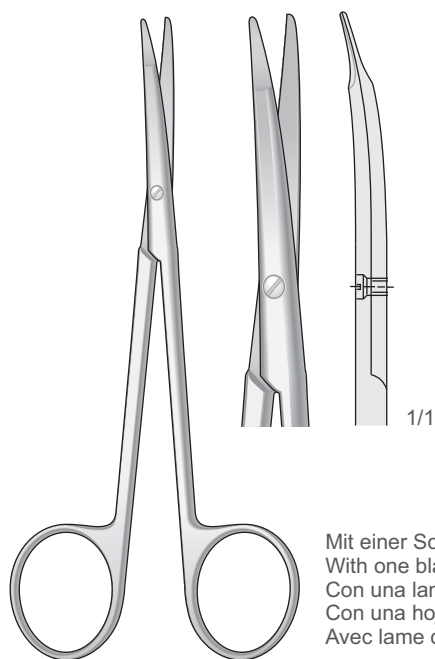

Mit einer Schneide gezahnt
With one blade serrated
Con una lama zigrinata
Con una hoja dentada
Avec lame dentelé

KILNER
FG-121
130 mm

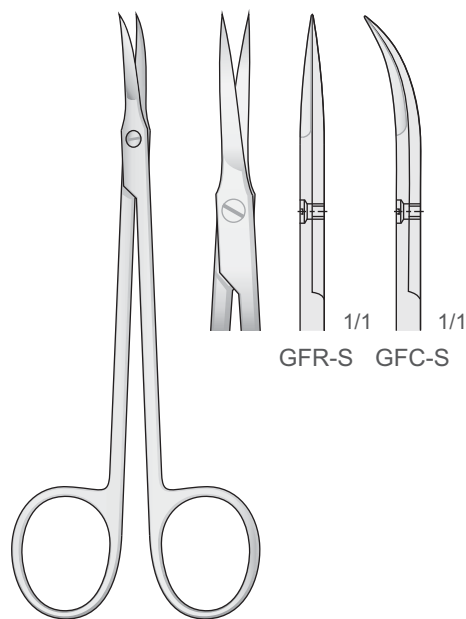

GFR-S/GFC-S
120 mm

Gezahnt - Serrated
Dentellata - Dentadas
Dentelé

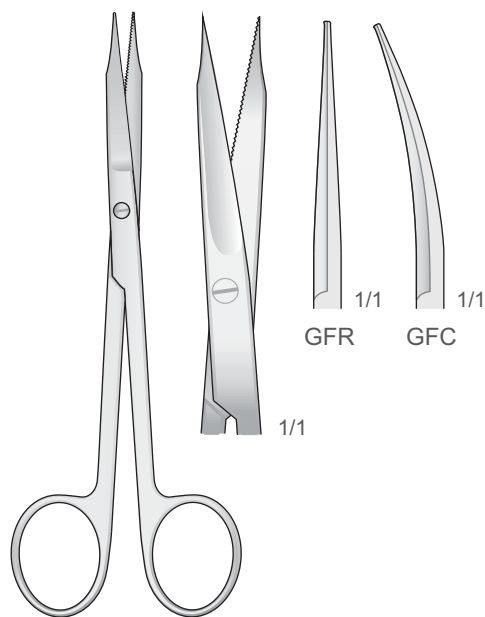

GOLDMAN-FOX
GFR/GFC
120 mm

Gezahnt - Serrated
Dentellata - Dentadas
Dentelé

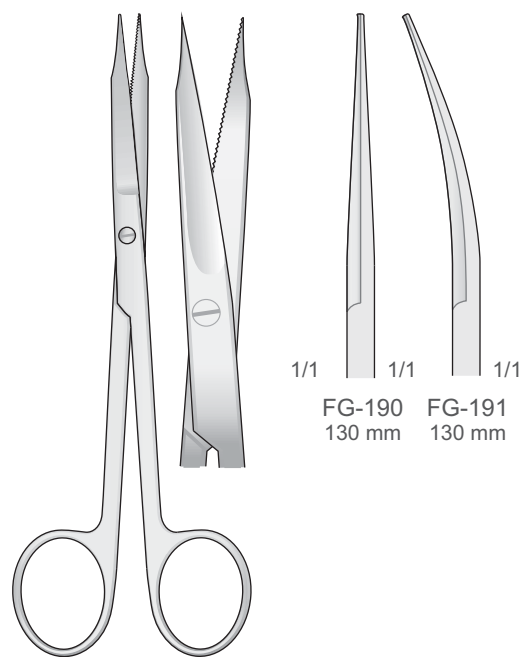

GOLDMAN-FOX
FG-190/FG-191
130 mm

Gezahnt - Serrated
Dentellata - Dentadas
Dentelé

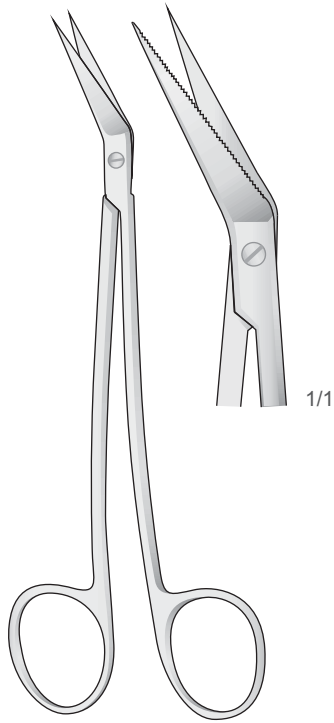

LOCKLIN
LK-2
160 mm

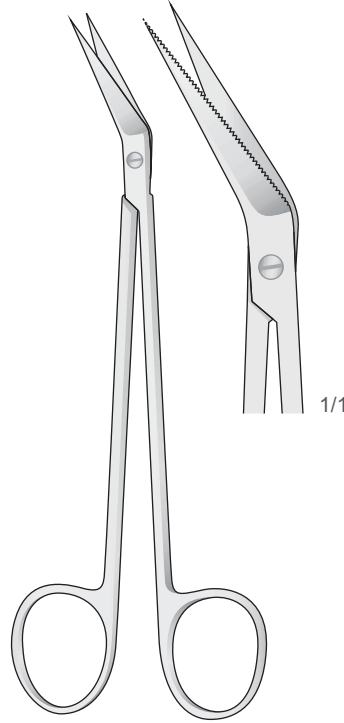

LOCKLIN
LK-4
160 mm

Gezahnt - Serrated
Dentellata - Dentadas
Dentelé

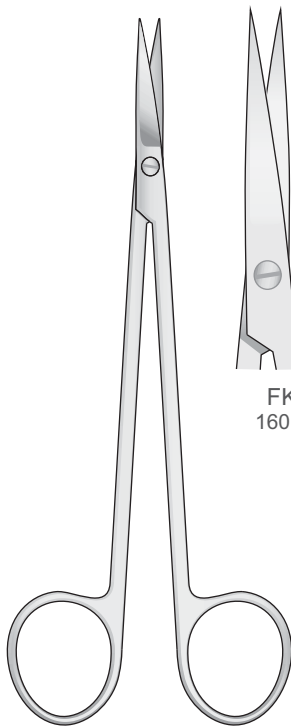

KELLY
FK-1/FK-2
160 mm

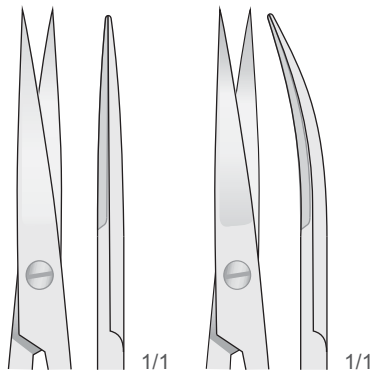

FK-1
160 mm

FK-2
160 mm

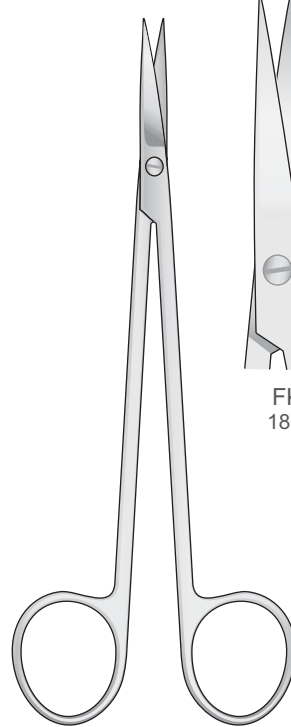

KELLY
FK-87/FK-88
180 mm

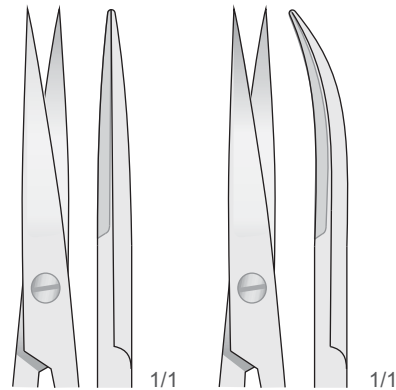

FK-87
180 mm

FK-88
180 mm



Scheren
Scissors
Forbici
Tijeras
Ciseaux

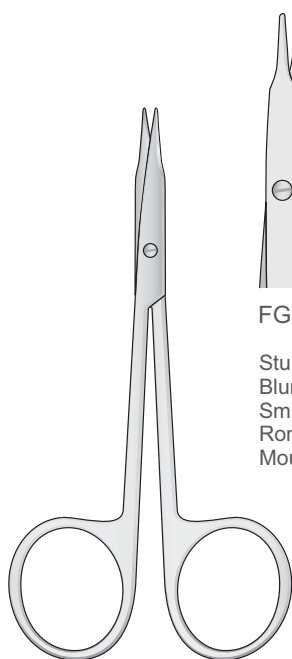

STEVENS
FG-50/FG-53
110 mm

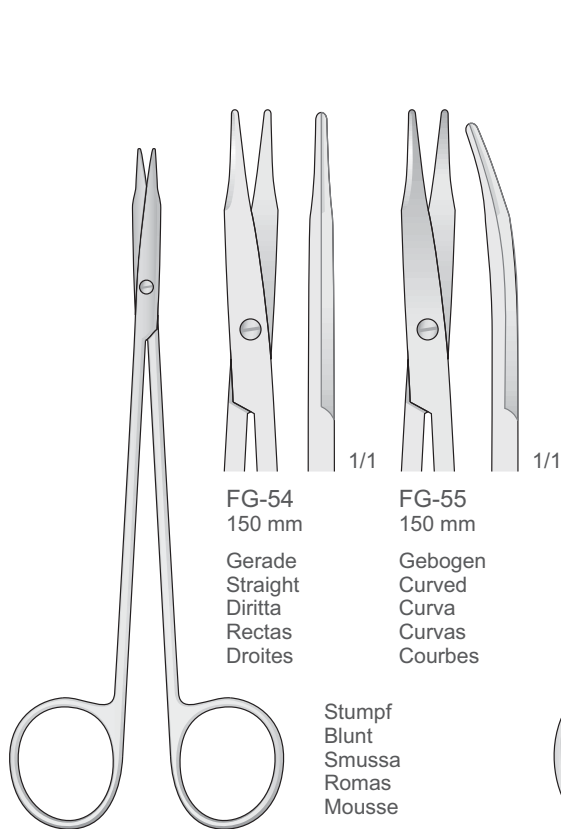
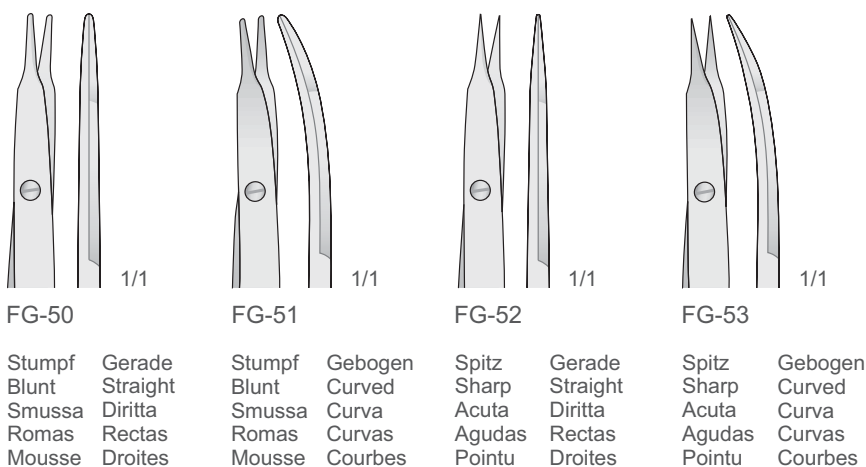

REYNOLDS
FG-54/FG-55

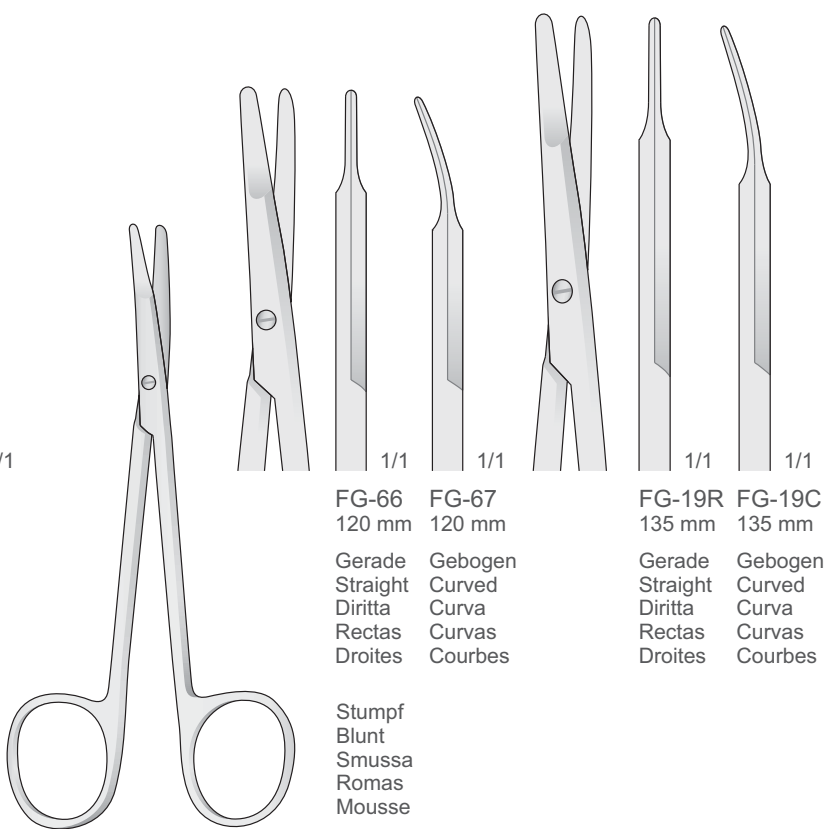

KILNER
FG-19C/FG-67

Gezahnt - Serrated
Dentellata - Dentadas
Dentelé

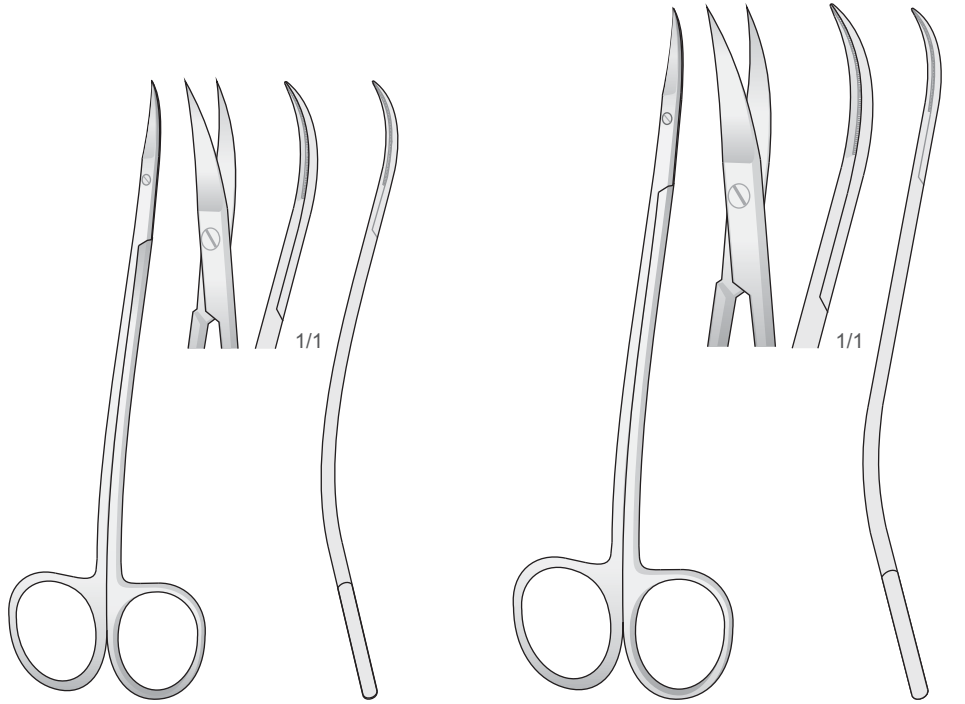

LA GRANGE
LG-1
115 mm

LA GRANGE
LG-6
155 mm

Gezahnt - Serrated
Dentellata - Dentada
Dentée

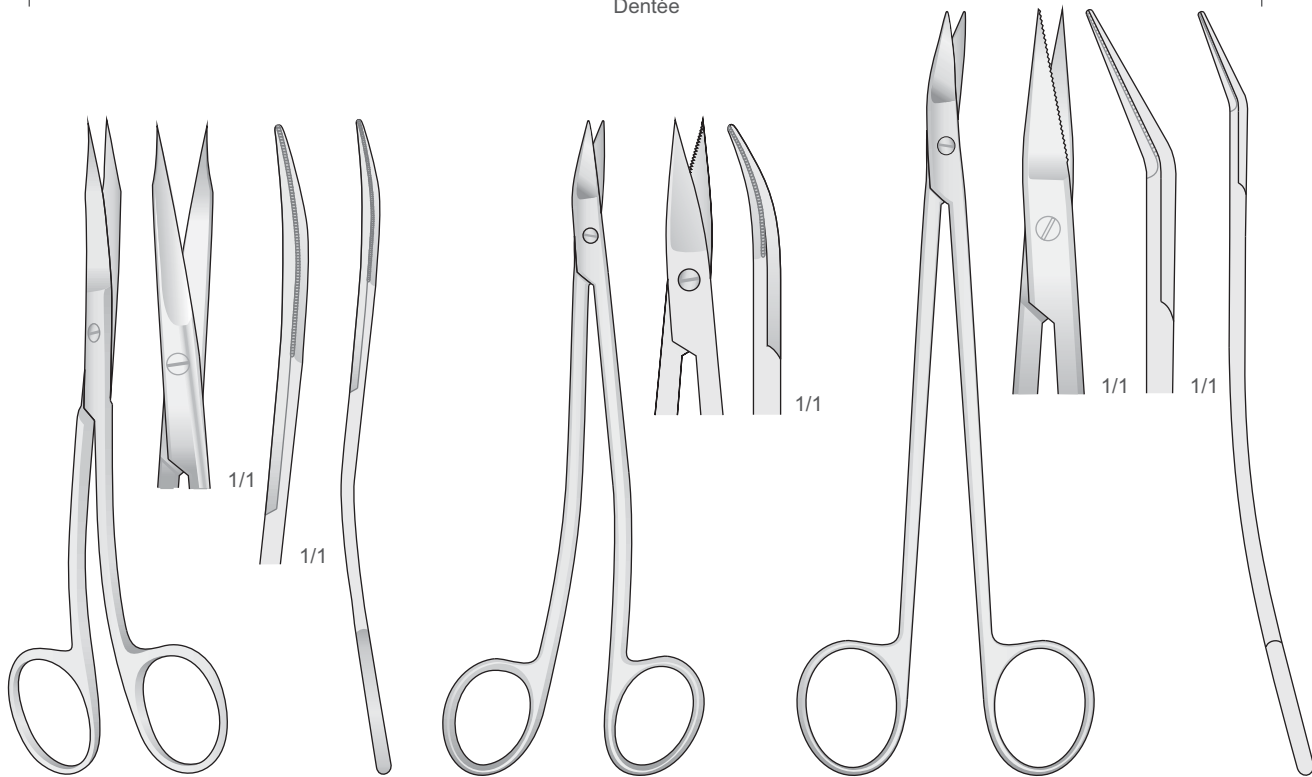

GOLDMAN-FOX S FORM
GFS
130 mm

NEUMANN
FG-20
130 mm

DEAN
DEAN
180 mm



Scheren
Scissors
Forbici
Tijeras
Ciseaux

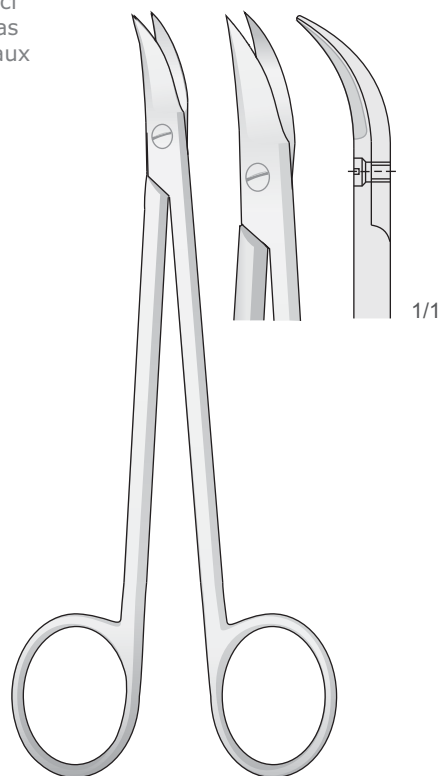

QUINBY
FG-38
130 mm

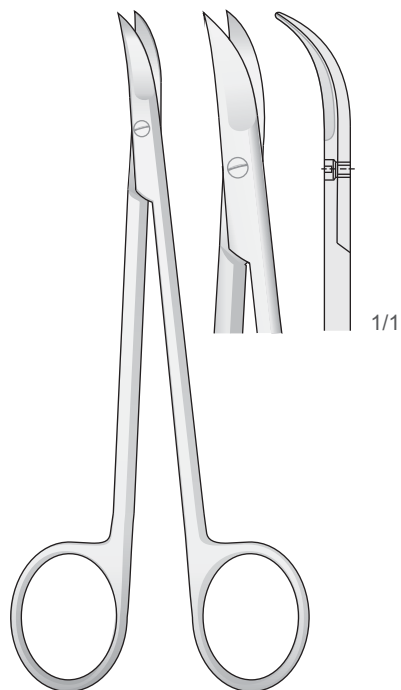

CHADWICK
FG-39
115 mm

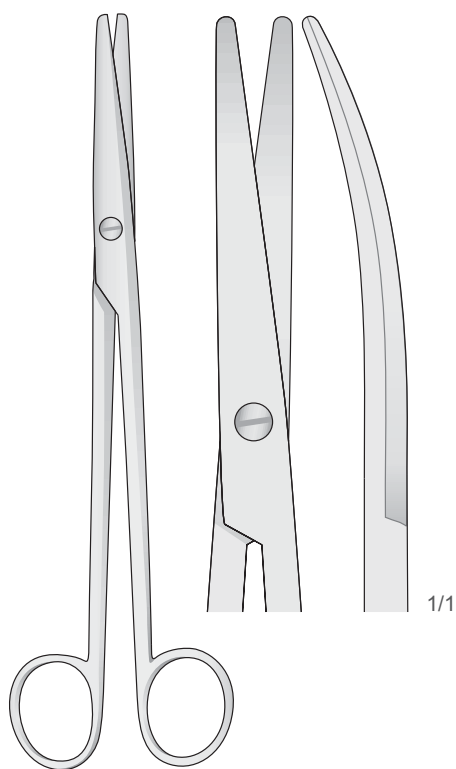

MAYO-LEXER
FM-79
165 mm

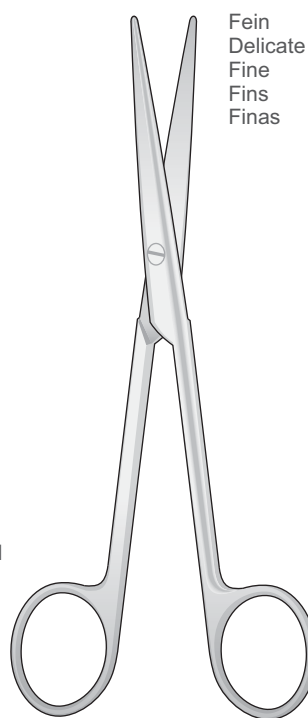

LEXER
FM-180/FM-181
165 mm

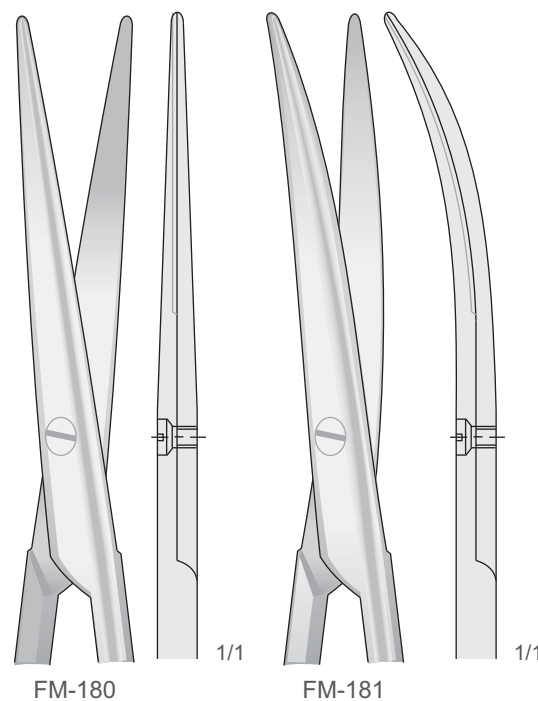

FM-180

FM-181

04

Scheren
Scissors
Forbici
Tijeras
Ciseaux

Stumpf
Blunt
Smusse
Romas
Mousses

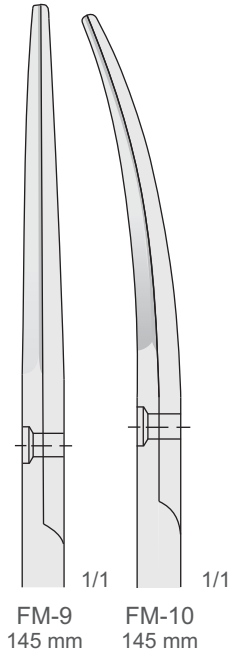
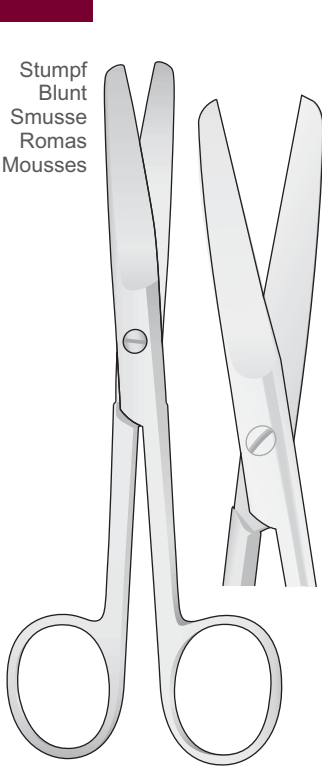

FM-9/FM-10
145 mm

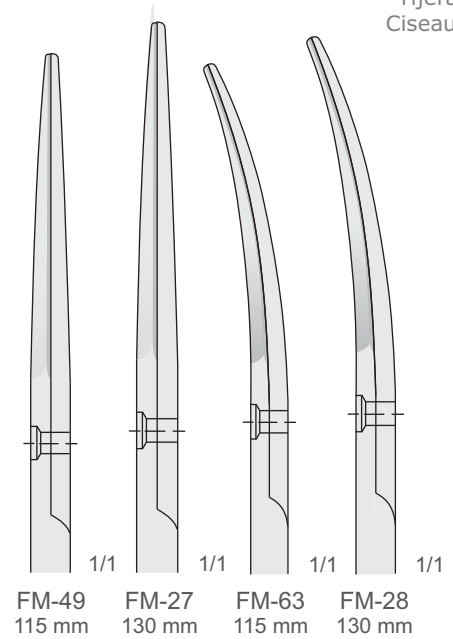
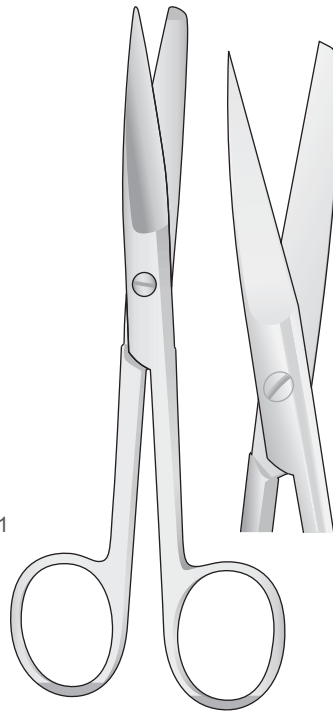

FM-27/FM-63

Stumpf
Blunt
Smusse
Romas
Mousses

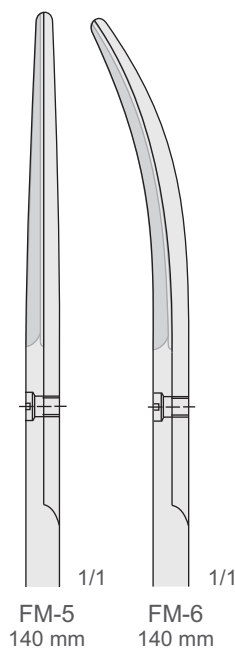
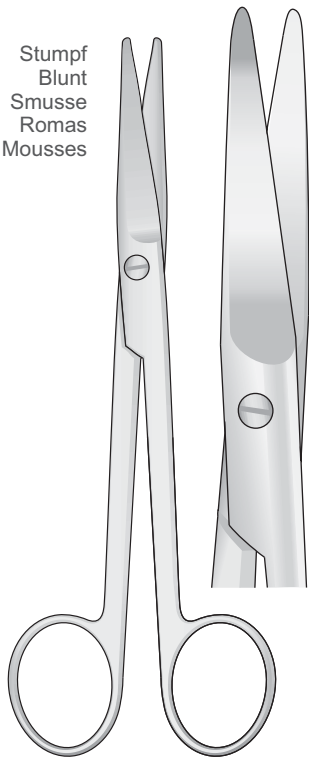

MAYO
FM-5/FM-6
140 mm

Spitz
Sharp
Acute
Agudo
Pointu

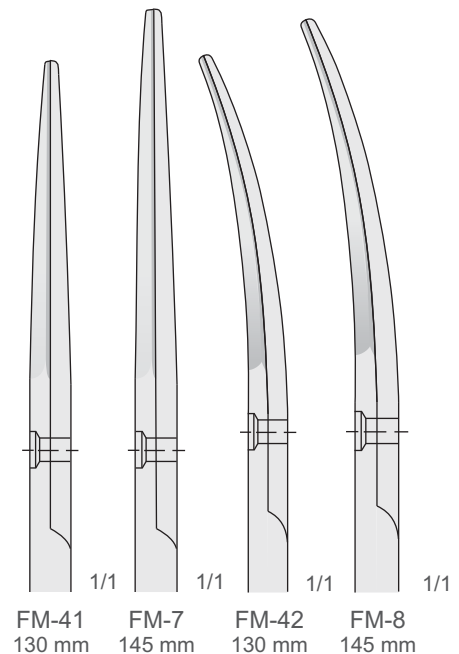
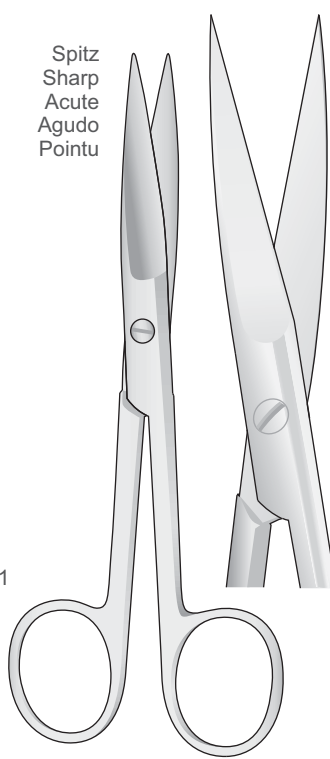

FM-7/FM-42



Scheren
Scissors
Forbici
Tijeras
Ciseaux

SUPER CUT

Regular
Edge

SUPER CUT
Edge

Super Cut Scissors have specially designed cutting edges.
One regular edge and **one sharp-knife edge.**

Extremely Sharp Razor Edge / Atraumatic
Extrem Scharfe Spitzer Beck / Atraumatische
Tranchant extrêmement aiguisée / Atraumática
Borde extremadamente afilado / Atraumática
Taglio estremamente affilato / Atraumatica

One side serrated
Eine seite gezahnt
Un côté dentelé
Un lado dentado
Un lato dentellato

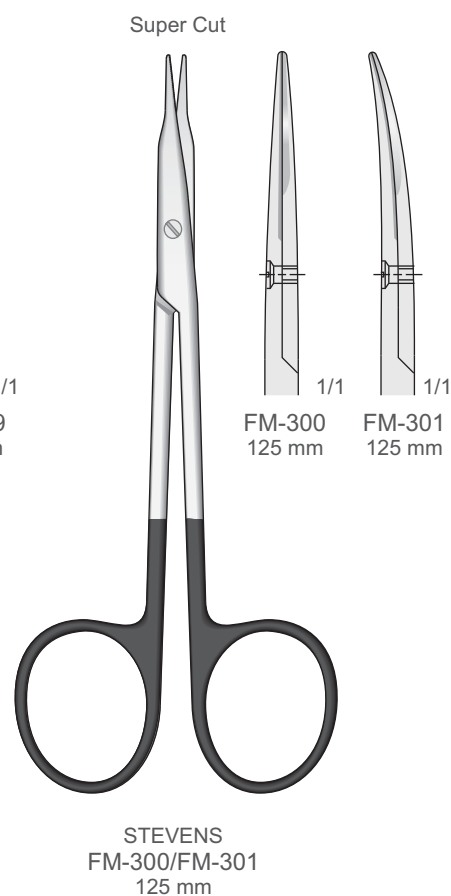
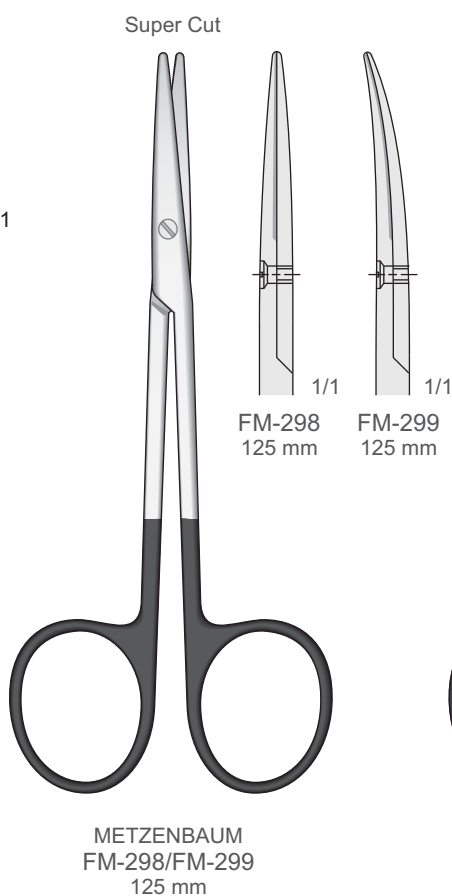
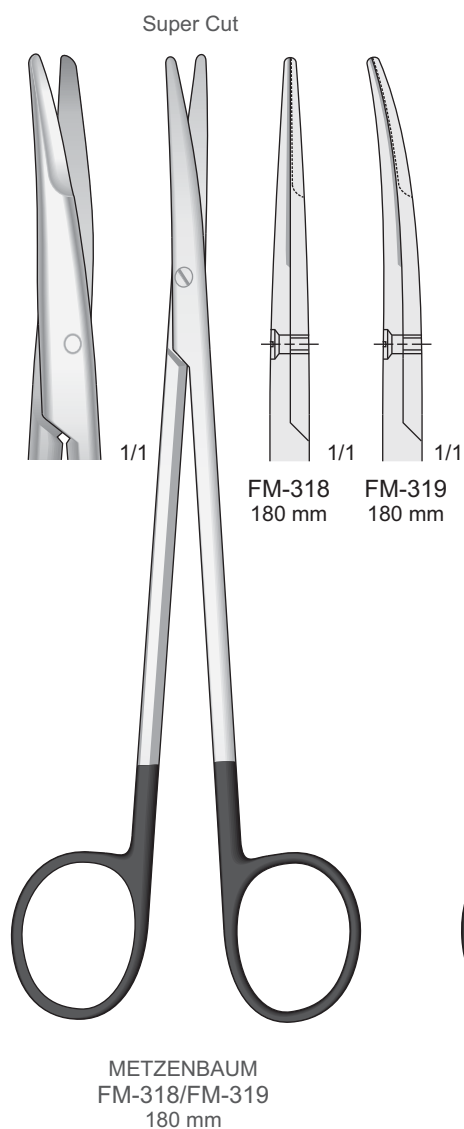

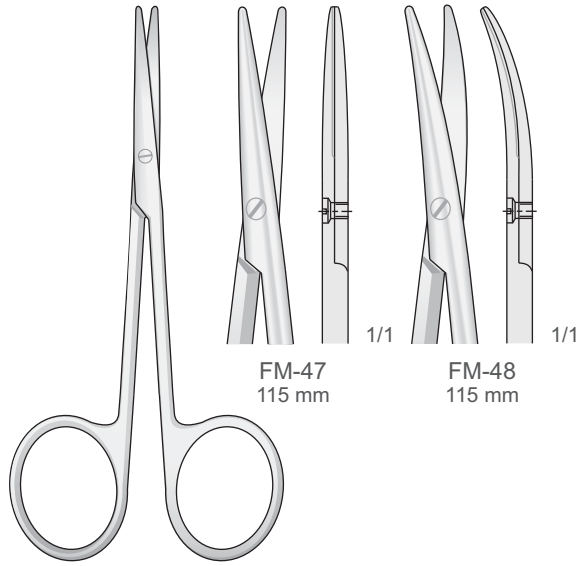

FM-47
115 mm

FM-48
115 mm

BABY - METZENBAUM
FM-47/FM-48
115 mm

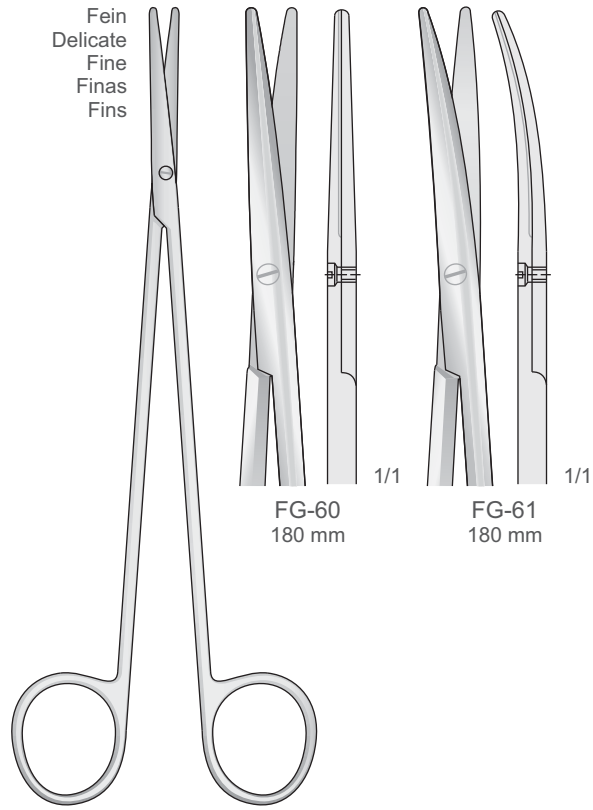

Fein
Delicate
Fine
Finas
Fins

FG-60
180 mm

FG-61
180 mm

TOENNIS-ADSON
FG-60/FG-61
180 mm

Präparierscheren - Dissecting Scissors
Forbici per dissezione - Tijeras de disección - Ciseaux à dissection

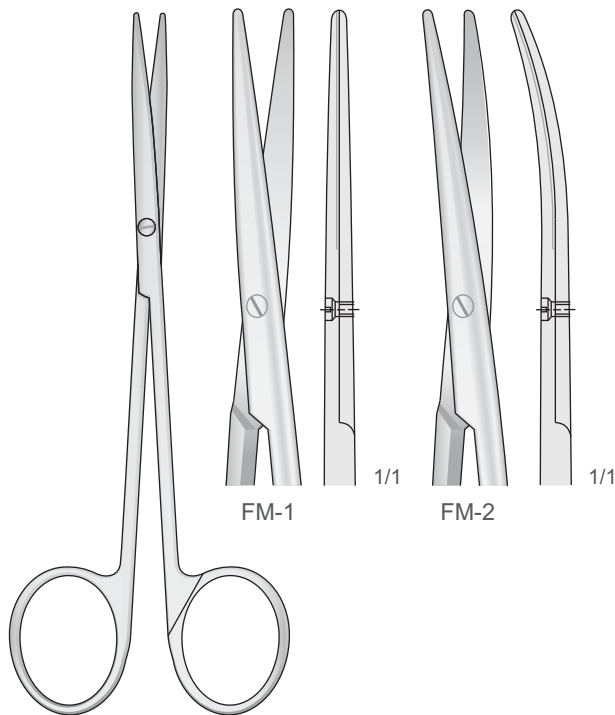

FM-1

FM-2

METZENBAUM
FM-1/FM-2
145 mm

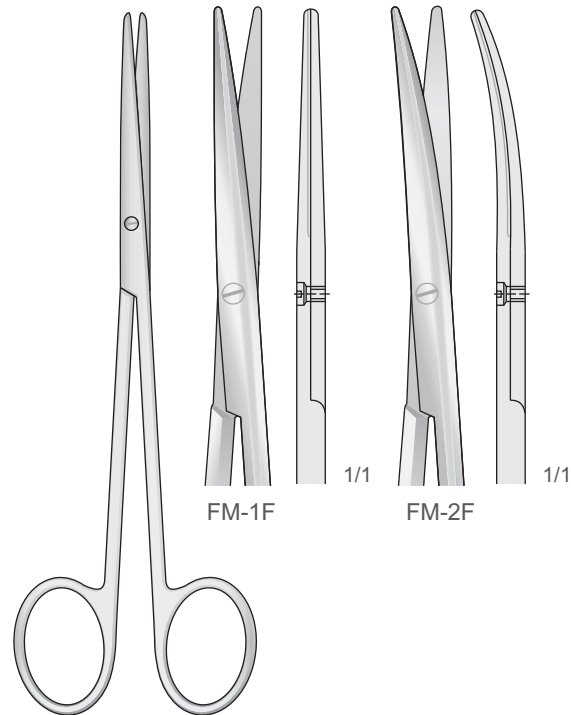

FM-1F

FM-2F

METZENBAUM-FINO
FM-1F/FM-2F
145 mm



Scheren
Scissors
Forbici
Tijeras
Ciseaux

04

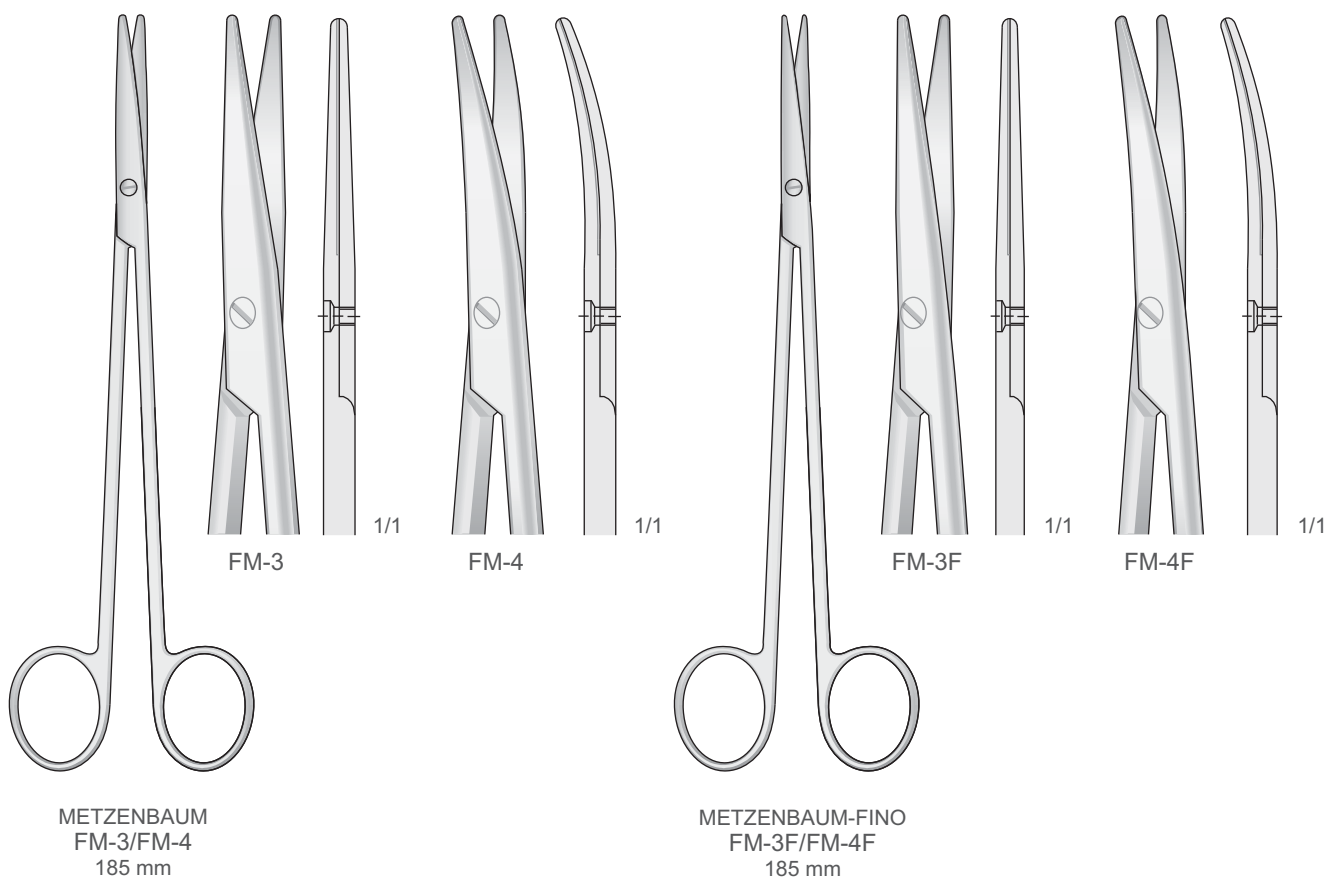
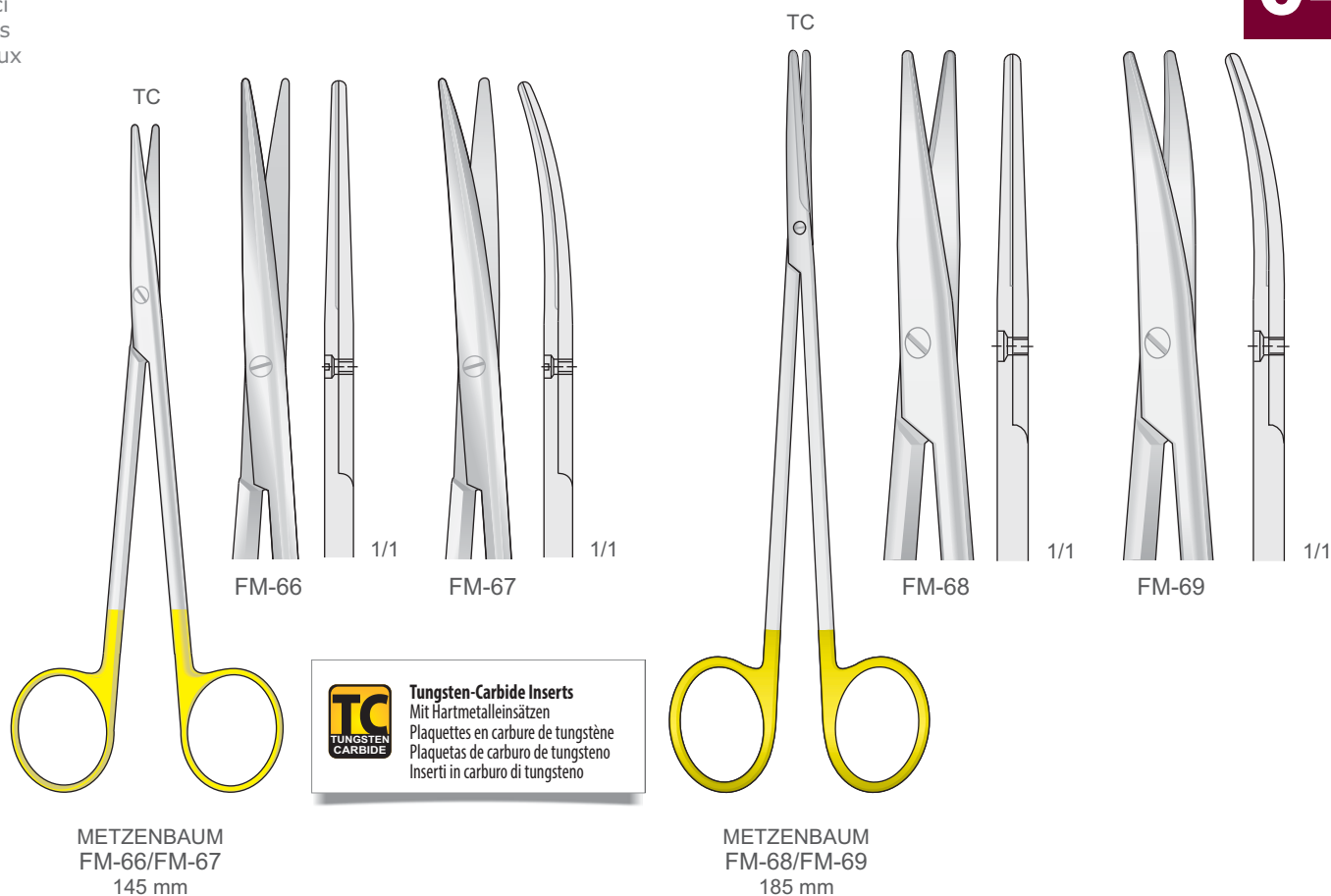

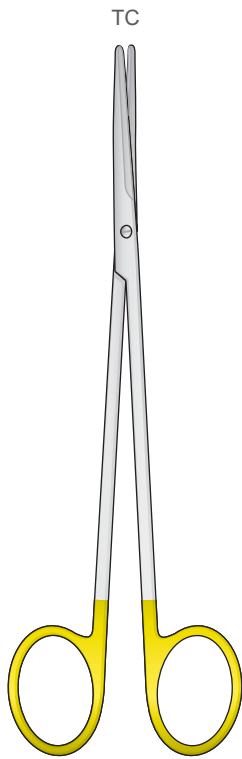

METZENBAUM-FINO
FM-201/FM-204

TC

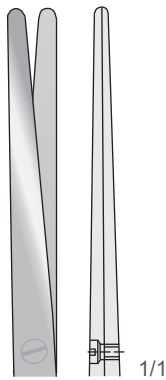

FM-201
140 mm

1/1

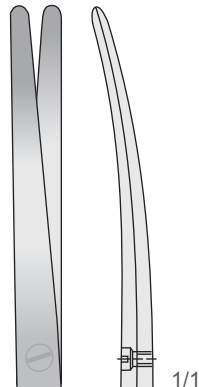

FM-202
140 mm

1/1

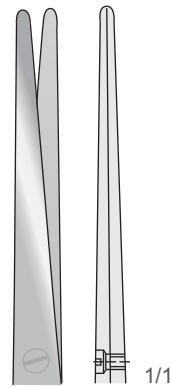

FM-203
180 mm

1/1

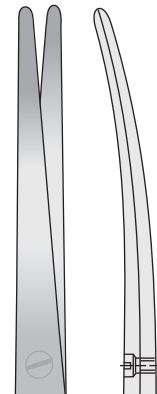

FM-204
180 mm

1/1



Tungsten-Carbide Inserts
Mit Hartmetalleinsätzen
Plaquettes en carbure de tungstène
Plaquetas de carburo de tungsteno
Inserti in carburo di tungsteno

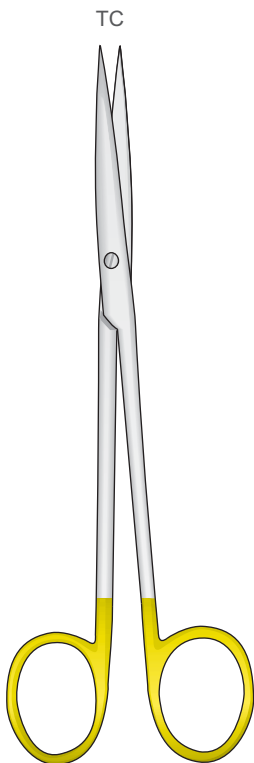

METZENBAUM-FINO
FM-96/FM-99

TC

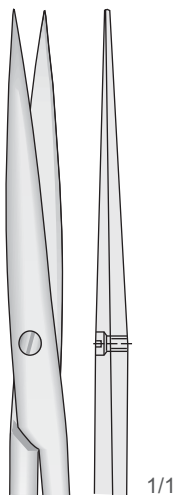

FM-96
140 mm

1/1

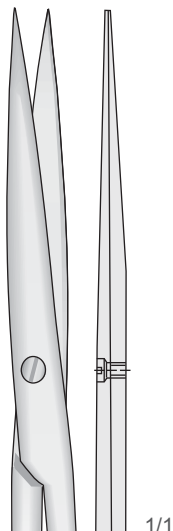

FM-97
180 mm

1/1

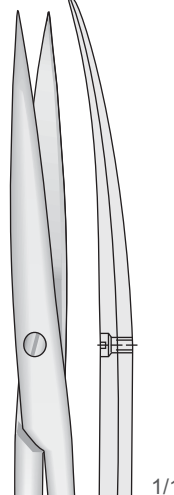

FM-98
140 mm

1/1

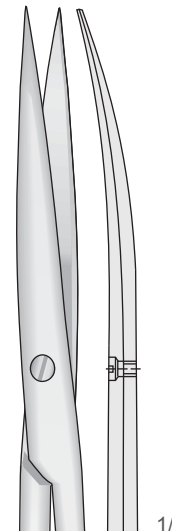

FM-99
180 mm

1/1



Scheren
Scissors
Forbici
Tijeras
Ciseaux



Tungsten-Carbide Inserts
Mit Hartmetalleinsätzen
Plaquettes en carbure de tungstène
Plaquetas de carburo de tungsteno
Inserti in carburo di tungsteno

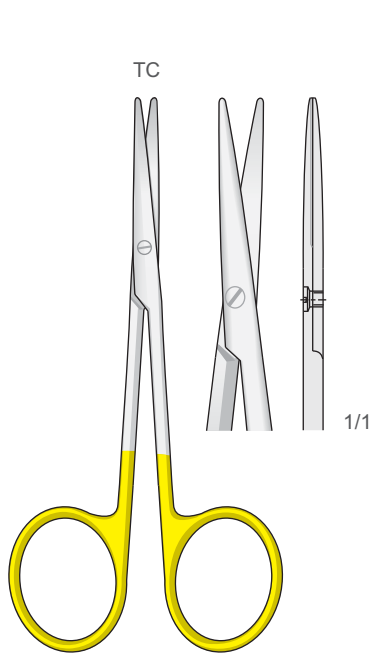

LEXER-BABY (KNAPP)
FM-118
115 mm

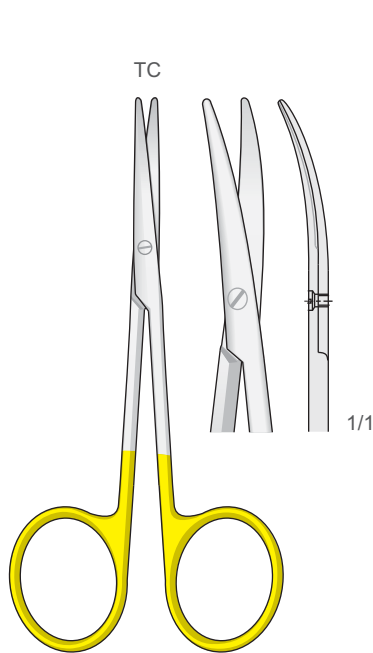

LEXER-BABY (KNAPP)
FM-119
115 mm

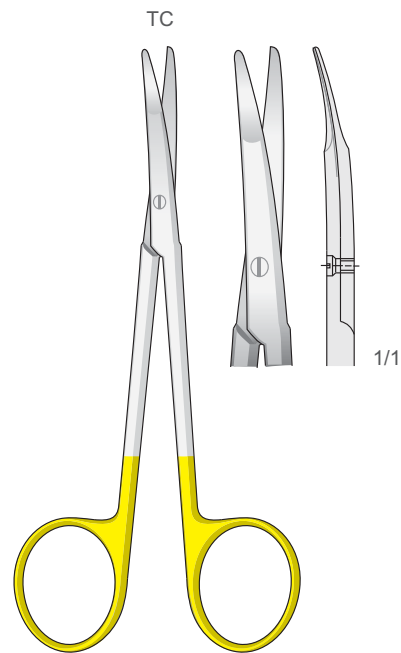

KILNER
FM-350
125 mm

Gebogen - Curved
Curva - Curvas
Courbes

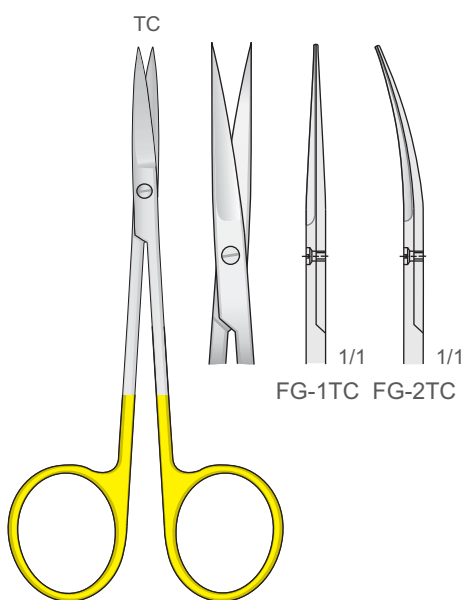

IRIS
FG-1TC/FG-2TC
115 mm

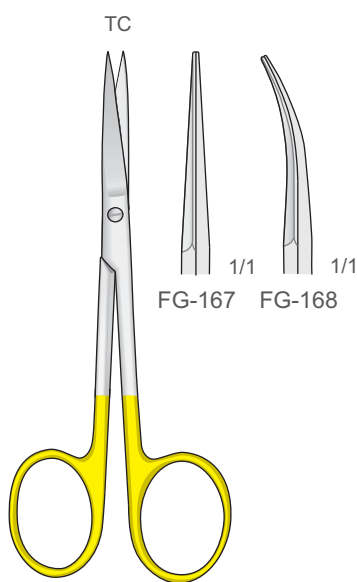

FG-167/FG-168
110 mm

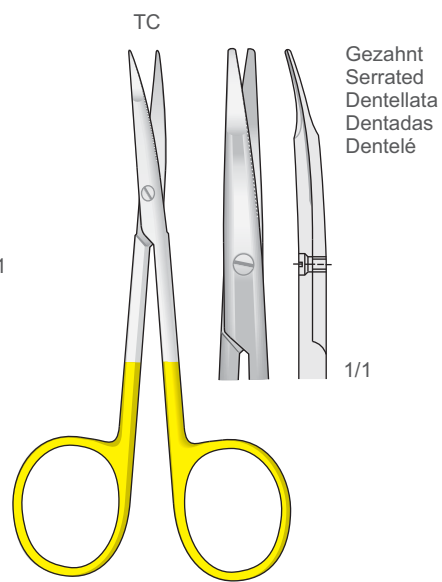

GREENBERG-PAR
FM-317
115 mm

Gezant
Serrated
Dentellata
Dentadas
Dentelé

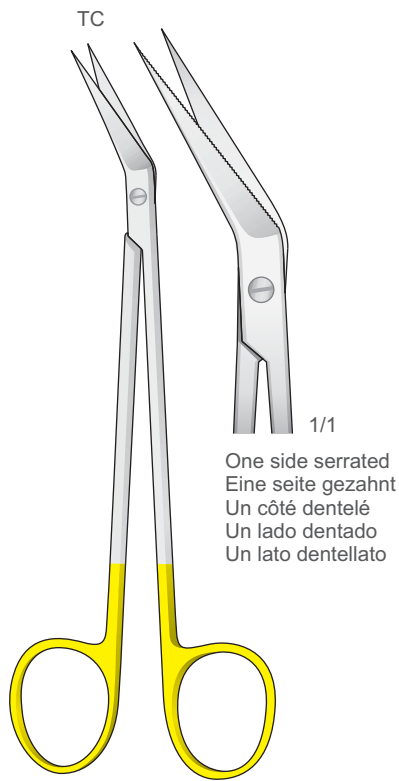

LK-10
160 mm

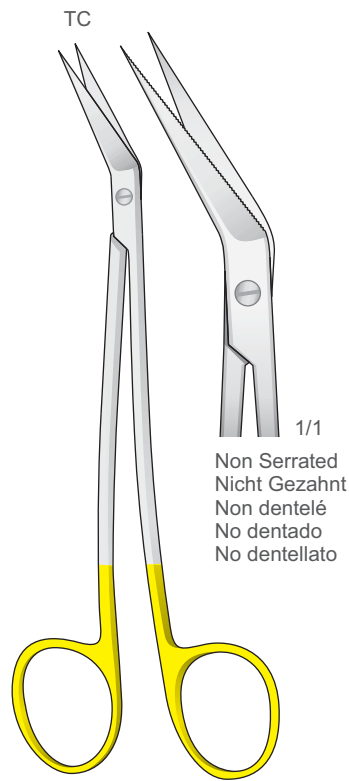

LK-12
160 mm

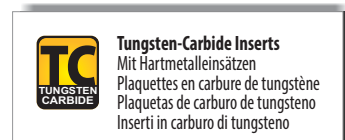

Eine Schneide gezahnt S-förmig gebogen
One toothed cutting edge S-shaped
Una lama dentata curva a forma S
Una hoja dentada forma S
Une lame dentelée courbés en S

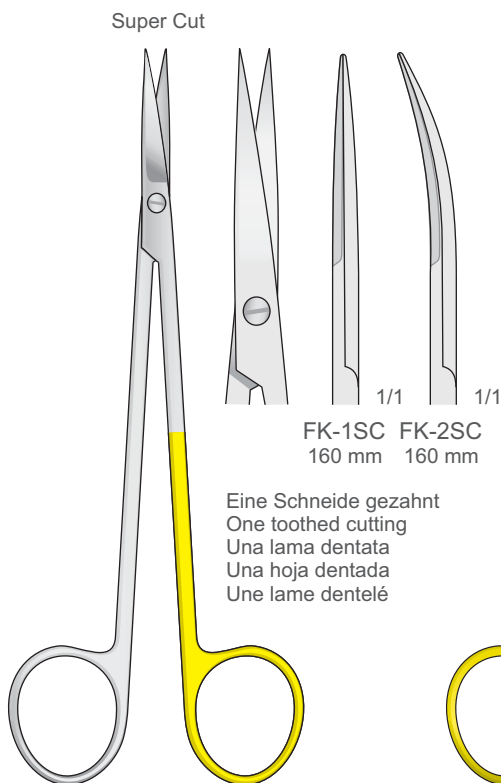

KELLY
FK-1SC/FK-2SC
160 mm

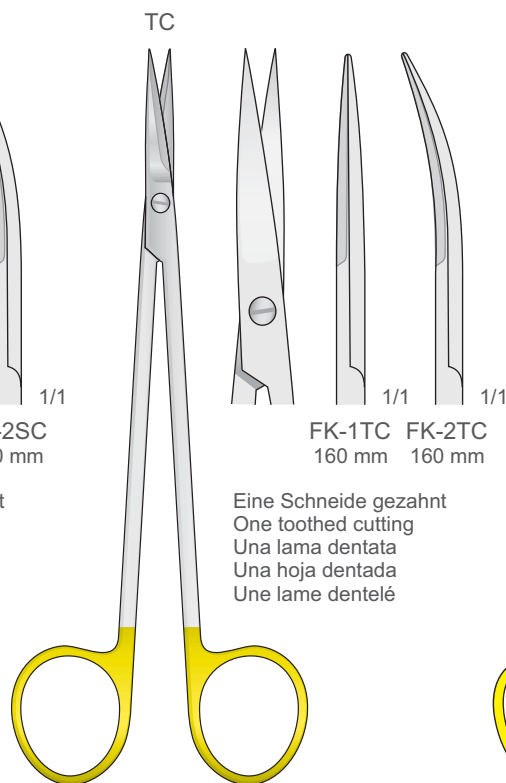

KELLY
FK-1TC/FK-2TC
160 mm

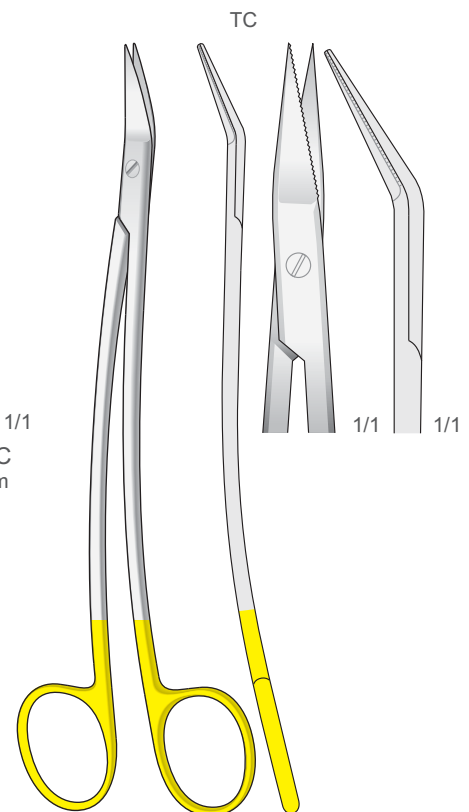

DEAN-TC
175 mm



Scheren
Scissors
Forbici
Tijeras
Ciseaux

04

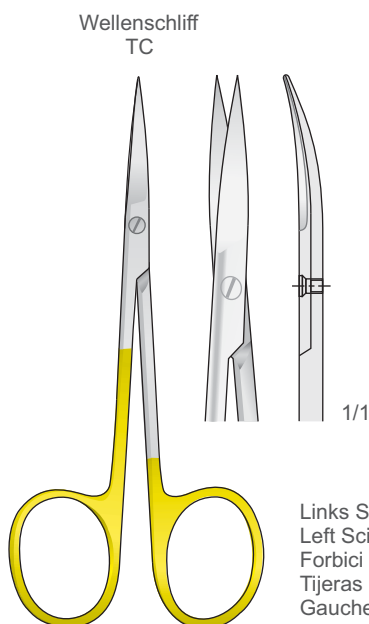

IRIS
FM-100L
110 mm

TC
TUNGSTEN
CARBIDE

Tungsten-Carbide Inserts
Mit Hartmetalleinsätzen
Plaquettes en carbure de tungstène
Plaquetas de carburo de tungsteno
Inserti in carburo di tungsteno

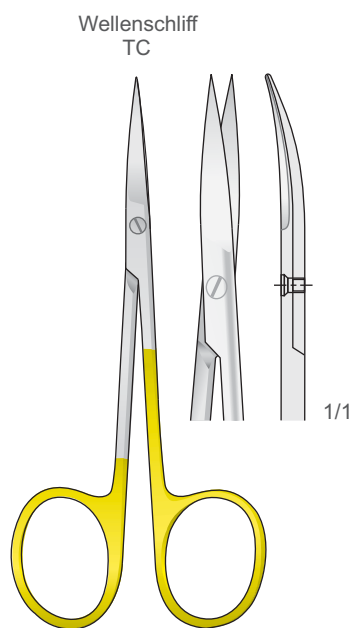

IRIS
FM-100
110 mm

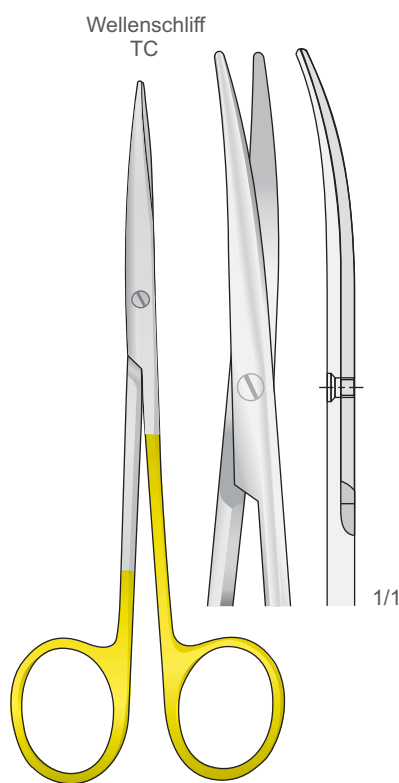

METZENBAUM
FM-102
145 mm

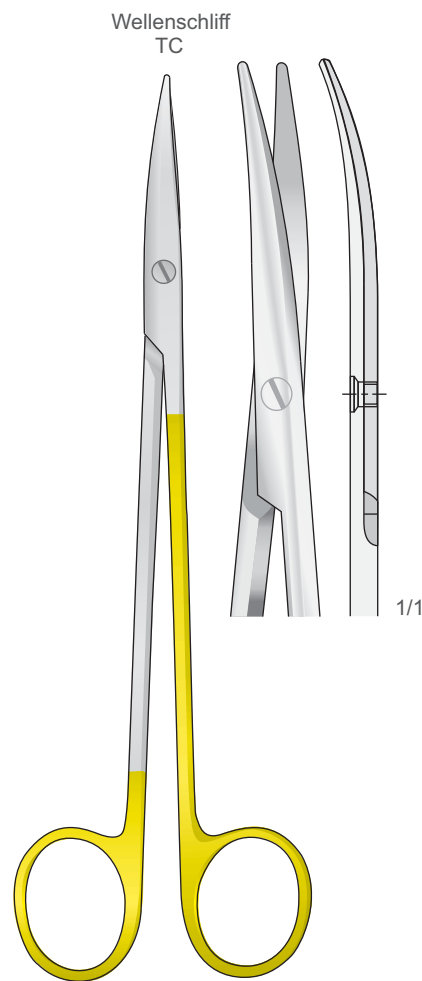

METZENBAUM
FM-104
185 mm



Extremely Sharp Razor Edge / Atraumatic
Extrem Scharfe Spitzer Beck / Atraumatische
Tranchant extrêmement aiguisée / Atraumatique
Borde extremadamente afilado / Atraumática
Taglio estremamente affilato / Atraumatica

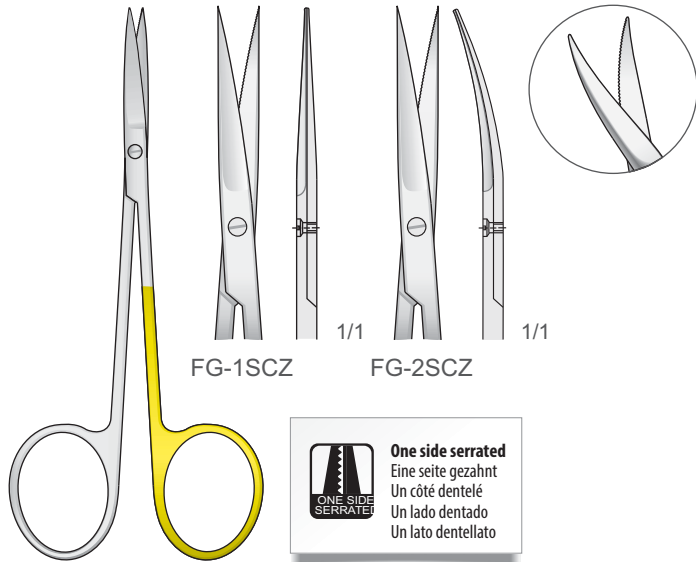

FG-1SCZ

FG-2SCZ



One side serrated
Eine seite gezahnt
Un côté dentelé
Un lado dentado
Un lato dentellato

FG-1SCZ/FG-2SCZ
110 mm

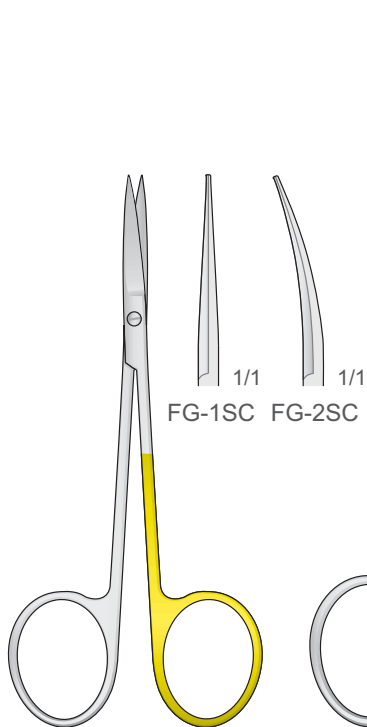

IRIS
FG-1SC/FG-2SC
110 mm

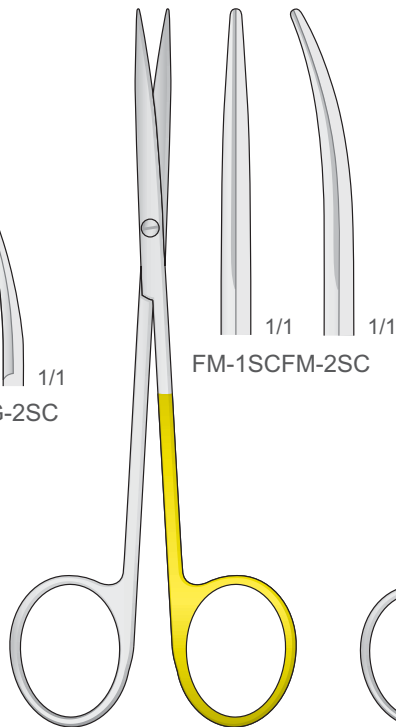

METZENBAUM
FM-1SC/FM-2SC
145 mm

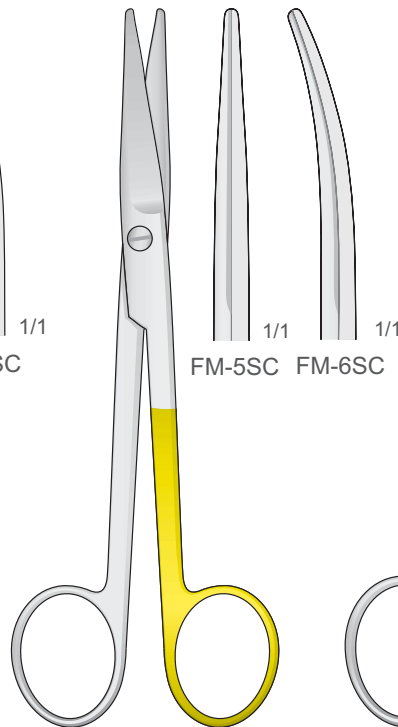

MAYO
FM-5SC/FM-6SC
140 mm

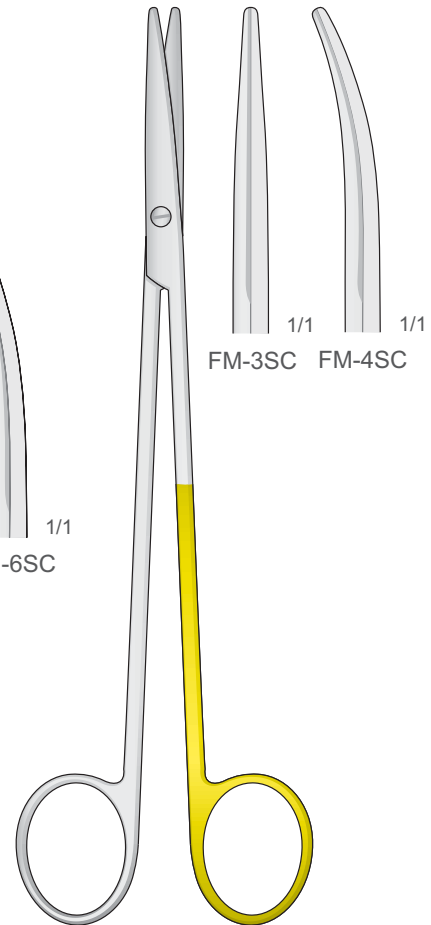

METZENBAUM
FM-3SC/FM-4SC
185 mm



Scheren
Scissors
Forbici
Tijeras
Ciseaux

SUPER CUT



Super Cut Scissors have specially designed cutting edges.
One regular edge and **one sharp-knife edge**.



Extremely Sharp Razor Edge / Atraumatic
Extrem Scharfe Spitzer Beck / Atraumatische
Tranchant extrêmement aiguisée / Atraumatique
Borde extremadamente afilado / Atraumática
Taglio estremamente affilato / Atraumatica



One side serrated
Eine seite gezahnt
Un côté dentelé
Un lado dentado
Un lato dentellato

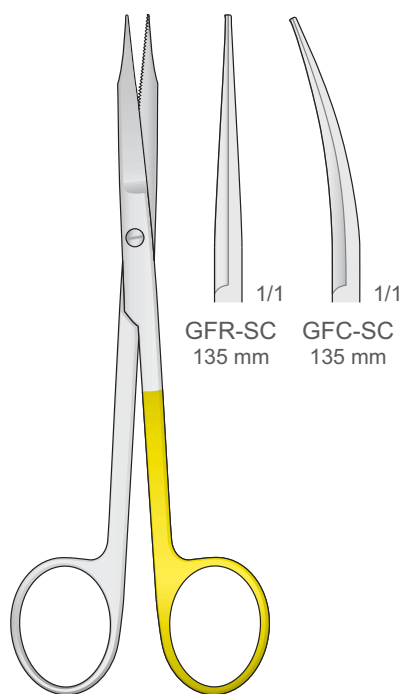

GOLDMAN-FOX
GFR-SC/GFC-SC
135 mm

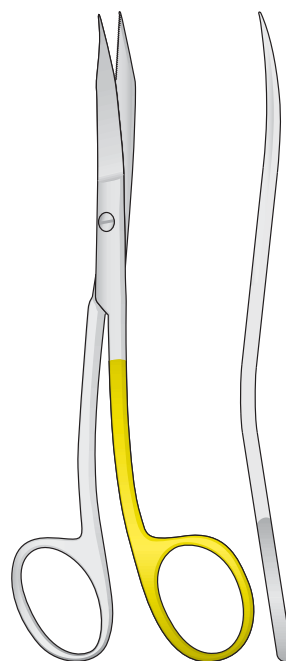

GOLDMAN-FOX S FORM
GFS-SC
130 mm

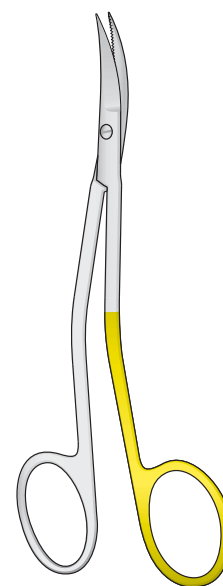

LA GRANGE
LG-1SC/LG-2SC
115 mm

Spitz
Sharp
Acute
Agudas
Pointu

Stumpf
Blunt
Smusse
Romas
Mousse

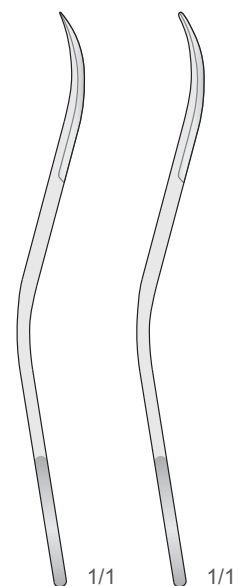

LA GRANGE
LG-1SC
LA GRANGE
LG-2SC

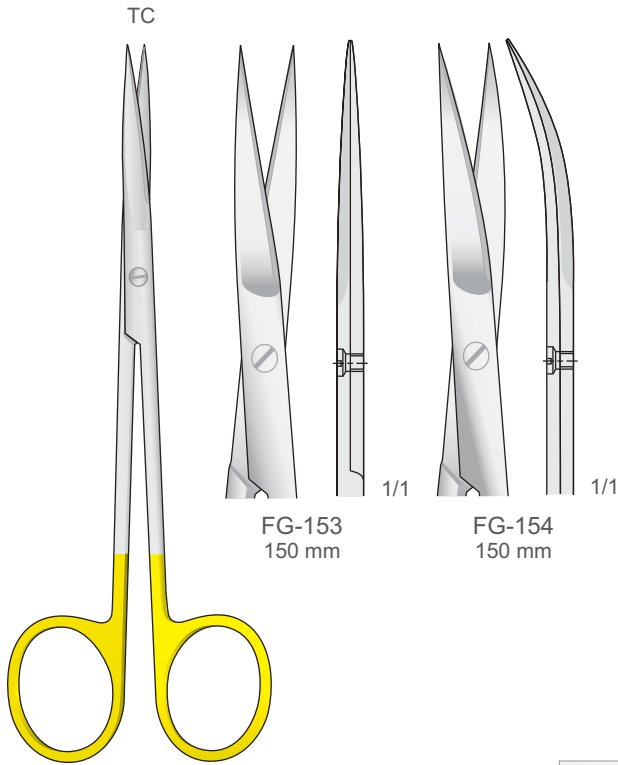

TC
TUNGSTEN
CARBIDE

Tungsten-Carbide Inserts
Mit Hartmetalleinsätzen
Plaquettes en carbure de tungstène
Plaquetas de carburo de tungsteno
Inserti in carburo di tungsteno

FG-153
150 mm

FG-154
150 mm

JOSEPH
FG-153/FG-154
150 mm

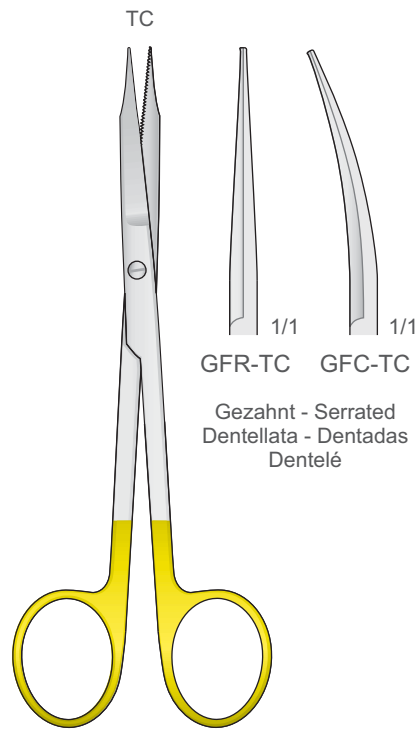

GFR-TC GFC-TC
Gezahnt - Serrated
Dentellata - Dentadas
Dentelé

GOLDMAN-FOX
GFC-TC/GFR-TC
135 mm

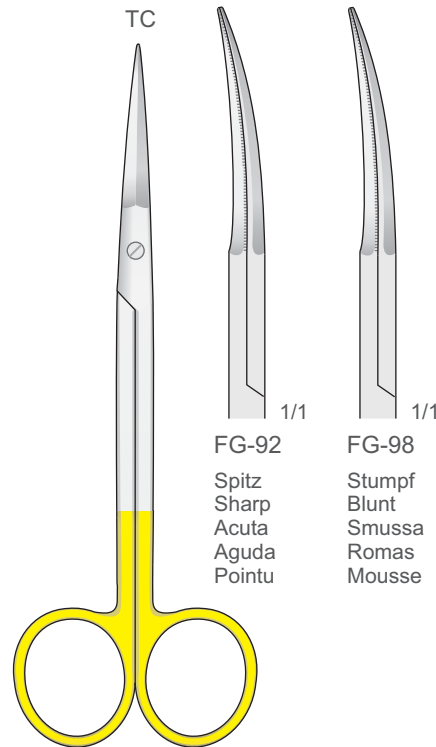

FG-92
Spitz
Sharp
Acuta
Aguda
Pointu

FG-98
Stumpf
Blunt
Smussa
Romas
Mousse

PECK-JOSEPH
FG-92/FG-98
140 mm

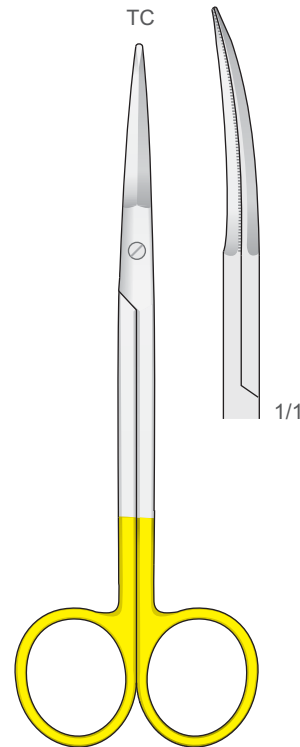

GREGORY
FM-339
140 mm



Scheren
Scissors
Forbici
Tijeras
Ciseaux

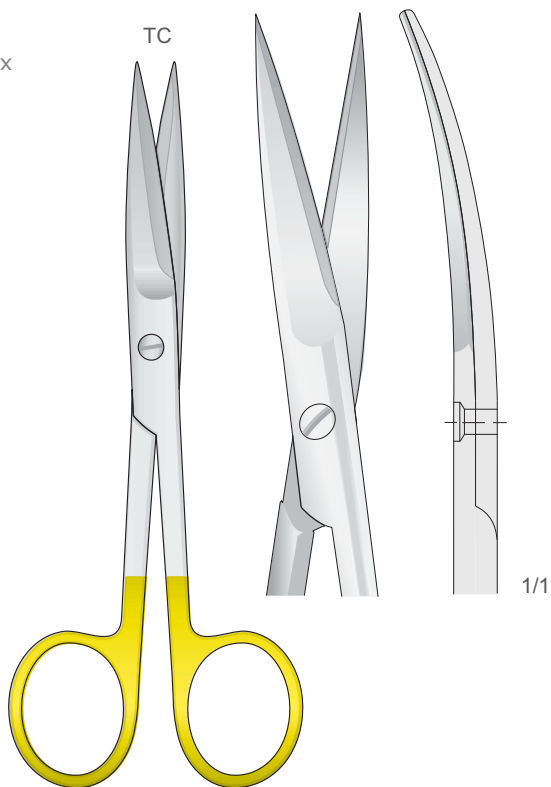

FM-146
145 mm

TC
TUNGSTEN
CARBIDE

Tungsten-Carbide Inserts
Mit Hartmetalleinsätzen
Plaquettes en carbure de tungstène
Plaquetas de carburo de tungsteno
Inserti in carburo di tungsteno

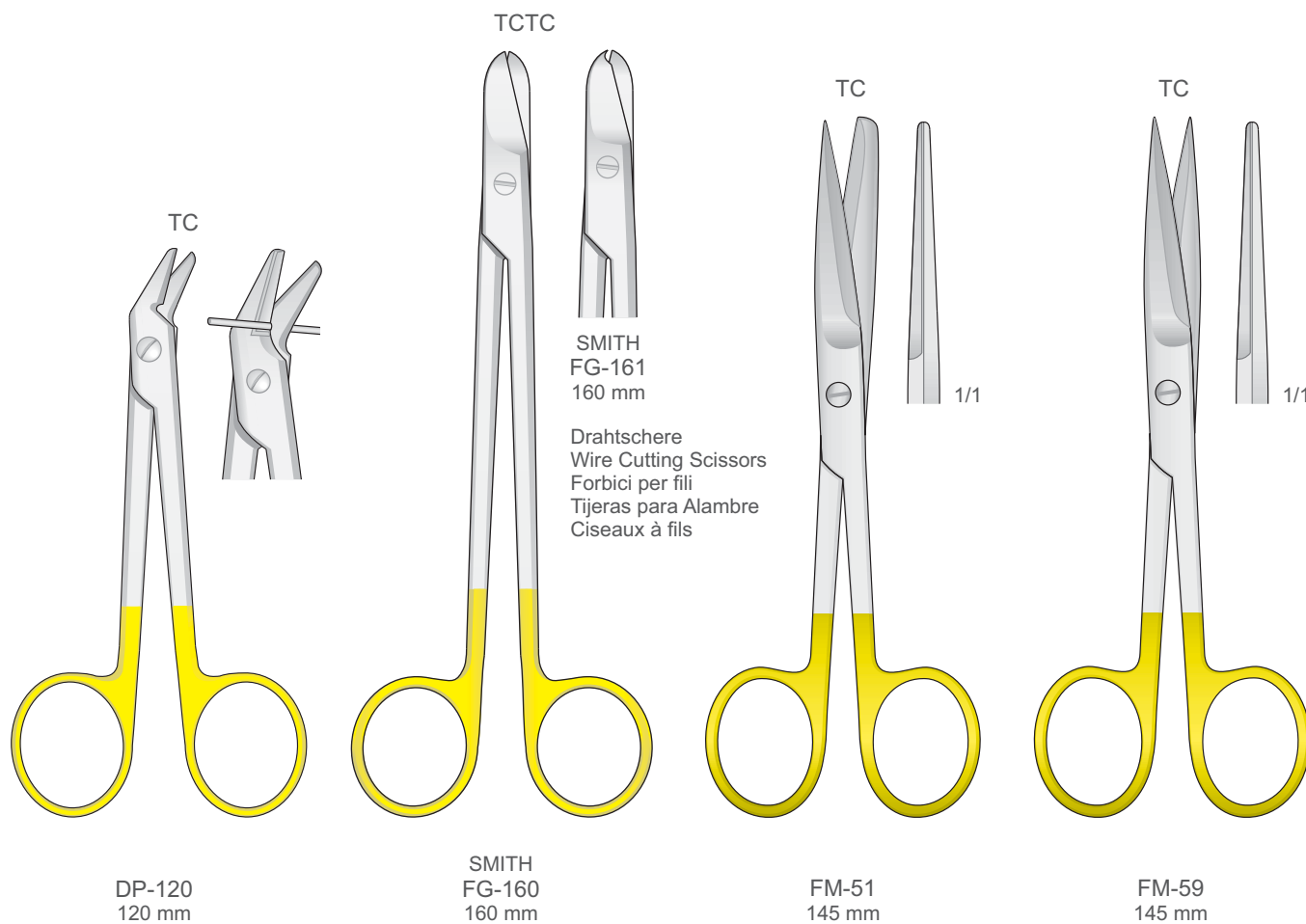

DP-120
120 mm

SMITH
FG-160
160 mm

FM-51
145 mm

FM-59
145 mm

SMITH
FG-161
160 mm

Drahtschere
Wire Cutting Scissors
Forbici per fili
Tijeras para Alambre
Ciseaux à fils

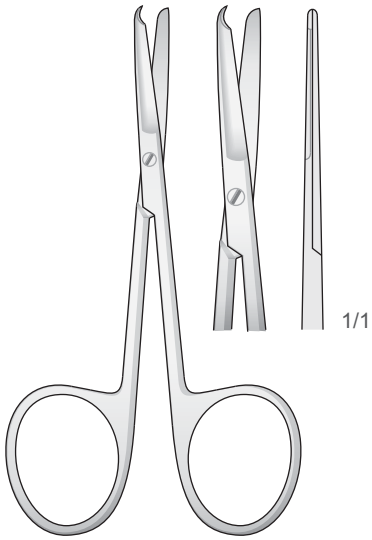

SPENCER
SC-9
90 mm

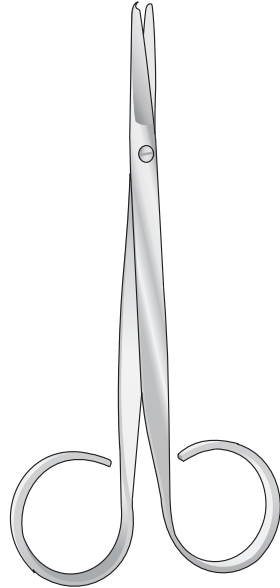

SPENCER
SC-1
110 mm

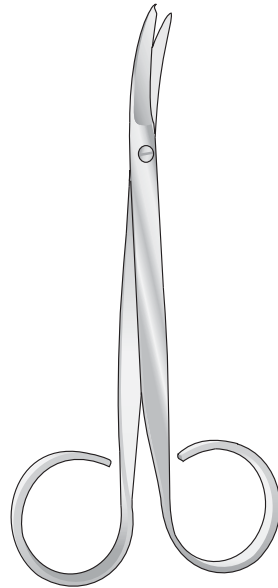

SPENCER
SC-5
110 mm

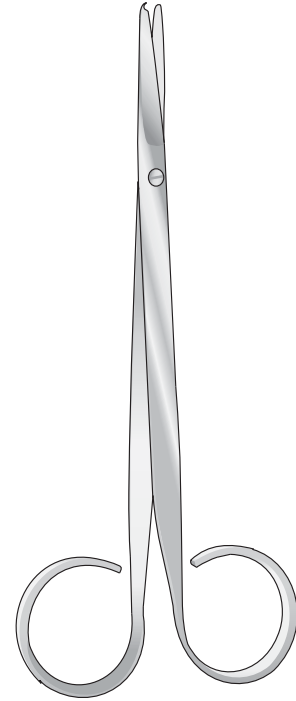

SPENCER
SC-2
145 mm

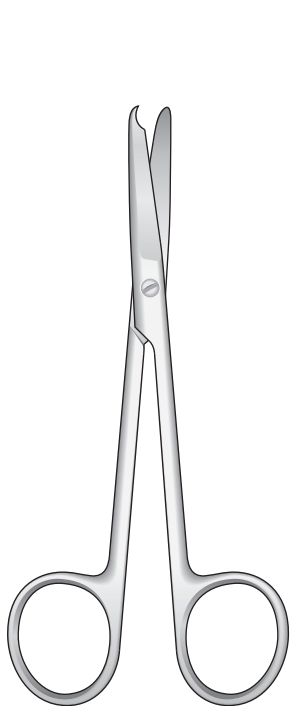

SPENCER
SC-14
120 mm

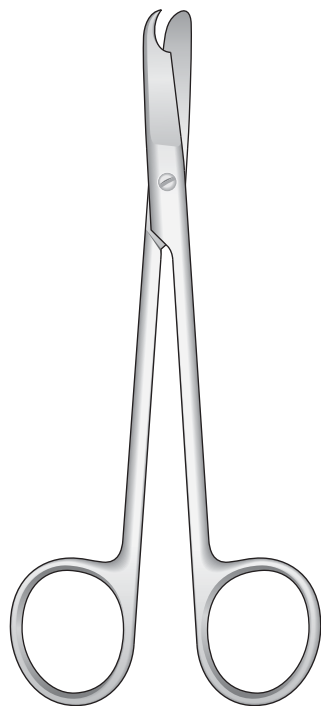

LITTAUER
SC-15
140 mm

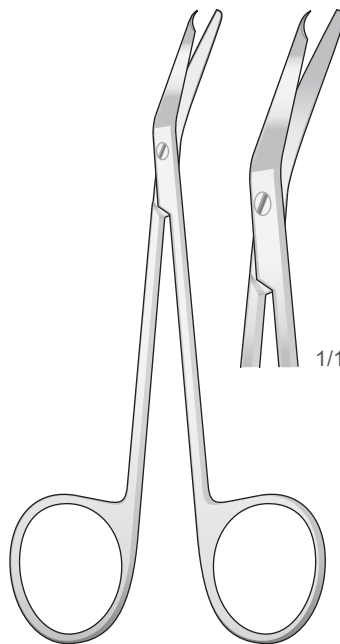

SPENCER
SC-13
130 mm

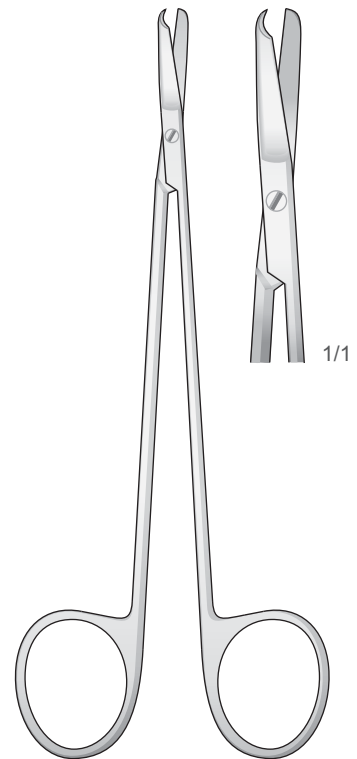

KELLY
SC-16
150 mm



Draht und blechscheren
Wire and plate cutting scissors
Forbici per fili metallici
Tijeras para cortar alambre
Ciseaux coupe-fils métalliques

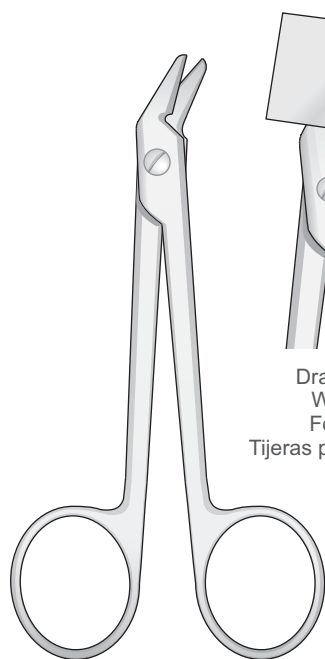

DP-90
120 mm

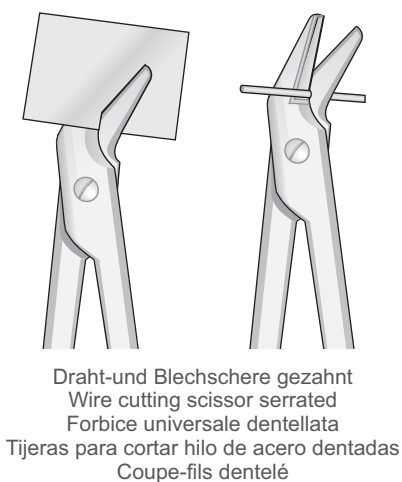

Draht-und Blechscherer gezahnt
Wire cutting scissor serrated
Forbice universale dentellata
Tijeras para cortar hilo de acero dentadas
Coupe-fils dentelé

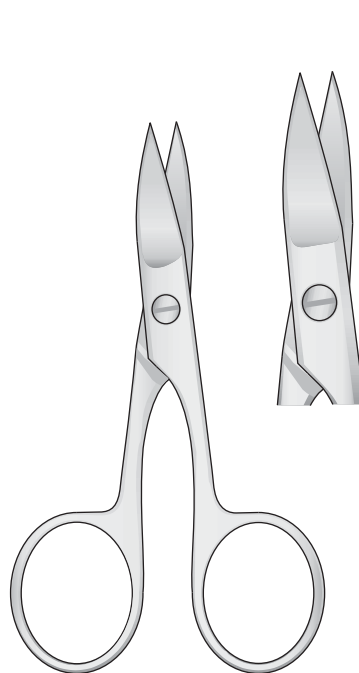

GS-26
110 mm

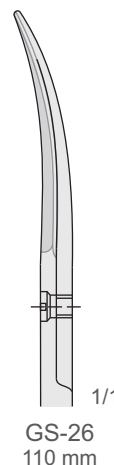

GS-26
110 mm

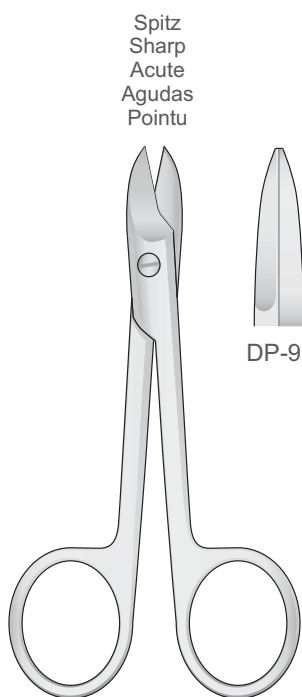

BEEBE
DP-91/DP-101
110 mm

Spitz
Sharp
Acute
Agudas
Pointu

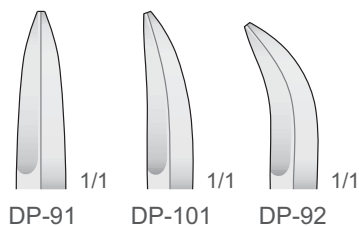

DP-91 1/1 DP-101 1/1 DP-92 1/1

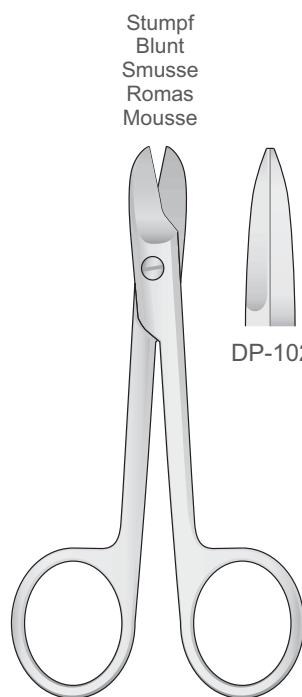

BEEBE
DP-102/DP-105
110 mm

Stumpf
Blunt
Smusse
Romas
Mousse

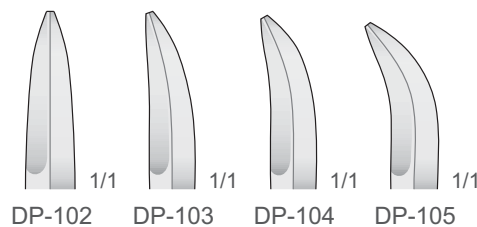

DP-102 1/1 DP-103 1/1 DP-104 1/1 DP-105 1/1

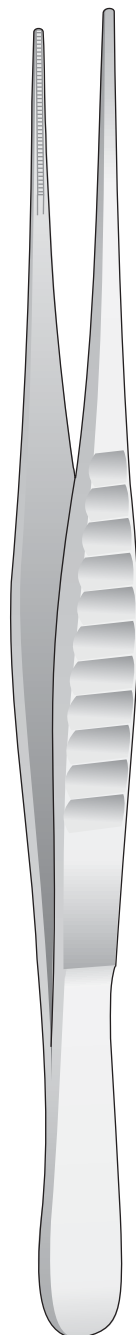

05 |

Tissue and Dressing Forceps
Chirurgische und Anatomische Pinzetten
Pinces à tissus et à pansement
Pinzas quirúrgicas y anatómicas
Pinzette chirurgiche e anatomiche



Mikro Pinzetten
Delicate Forceps
Micro Pinzette
Pinzas finas
Micro Pincas

05

0,2 mm

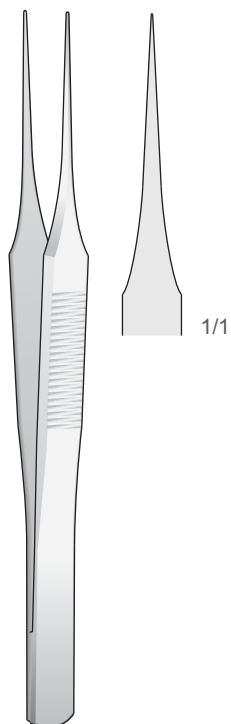

BD-360
110 mm

0,3 mm

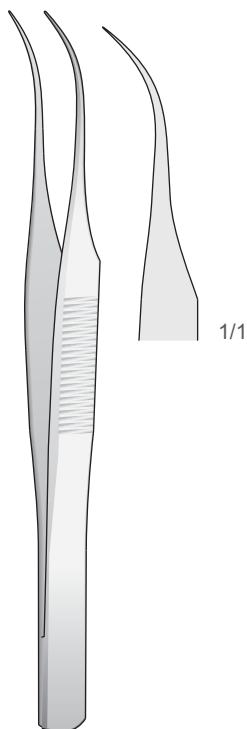

BD-361
110 mm

0,25 mm

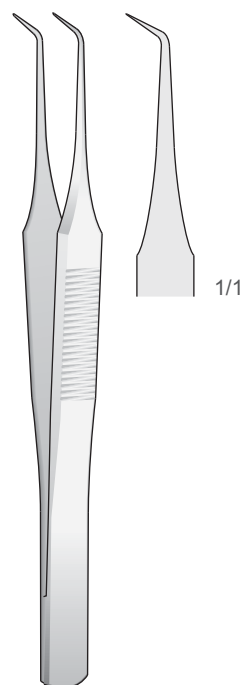

BD-362
100 mm

0,15 mm

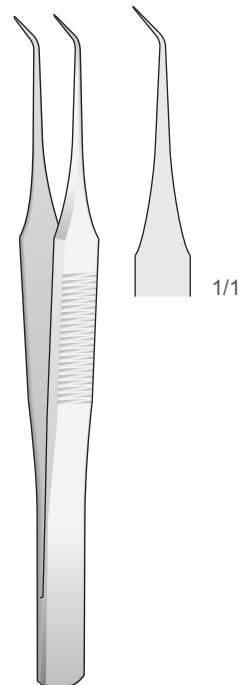

BD-363
100 mm

0,4 mm

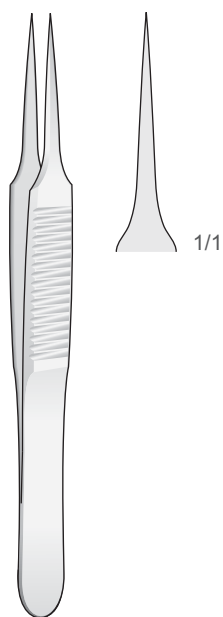

BD-364
110 mm

0,4 mm

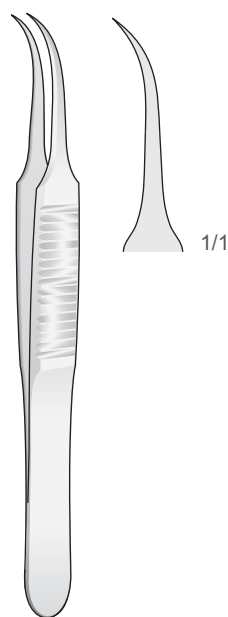

BD-365
110 mm

0,4 mm

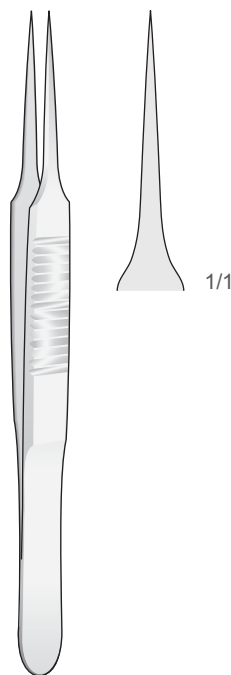

BD-366
130 mm

0,4 mm

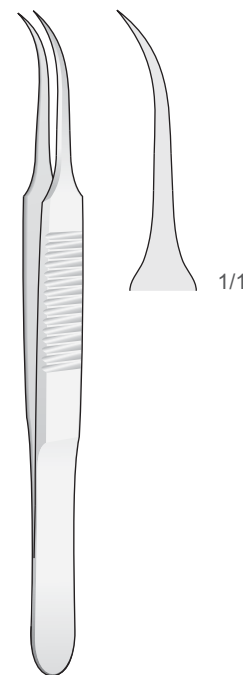

BD-367
130 mm



Diamond Tip
Diamantiert
Punta diamantata
Punta de diamante
Pointe de diamant

Tissue Forceps
1x2 Teeth

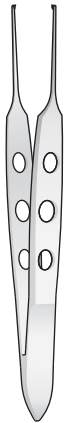
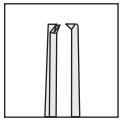

BISHOP-HARMON
MF-177 1,2 mm
85 mm

Dressing Forceps
criss-cross serrated tips

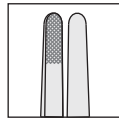

BISHOP-HARMON
MF-249 1,2 mm
85 mm

1/1

1x2 Zähne
1x2 Teeth
1x2 Denti
1x2 Dientes
1x2 Dents



CASTROVIEJO
BD-348 0.9 mm
120 mm

1/1

9x9 Zähne
9x9 Teeth
9x9 Denti
9x9 Dientes
9x9 Dents



BROWN
BD-349
120 mm

1,2 mm

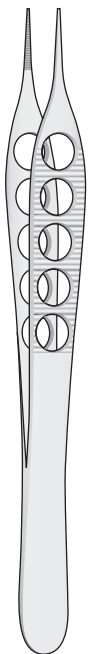

ADSON
BD-207
120 mm

1,2 mm

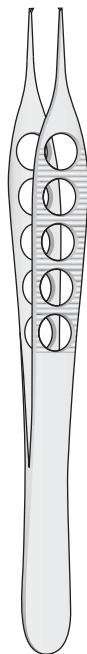

ADSON
BD-208
120 mm

1/1

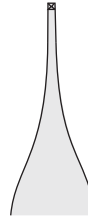

1/1

ADSON-BROWN
BD-209
120 mm

1/1



1/1

7x7 Zähne
7x7 Teeth
7x7 Denti
7x7 Dientes
7x7 Dents

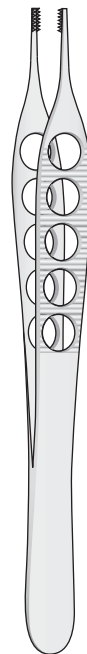

TC



ADSON-BROWN
BD-253
120 mm

1/1



Mikro Pinzetten
Delicate Forceps
Micro Pinzette
Pinzas finas
Micro Pincers

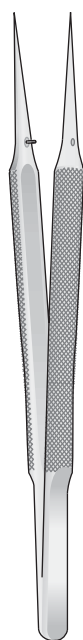
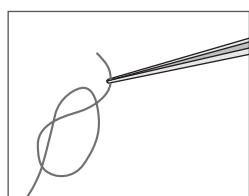

MF-110/MF-111
120 mm

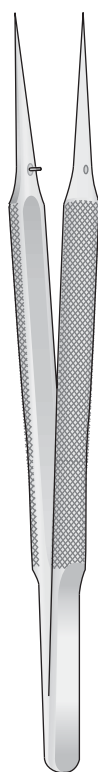
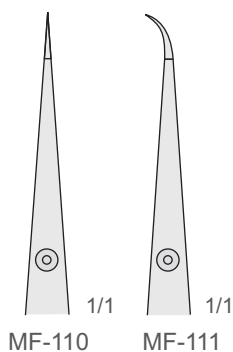

MF-112/MF-113
150 mm

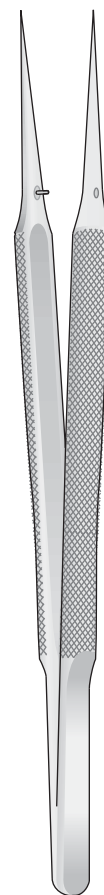
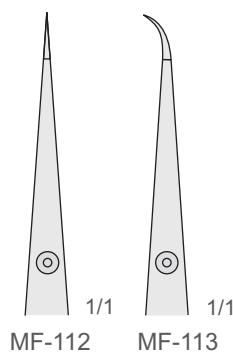

MF-114/MF-115
180 mm

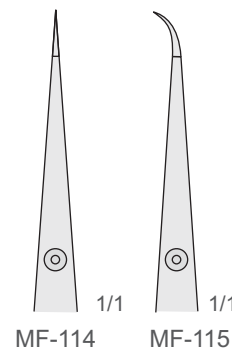

Mikro Pinzette - Rundgriff Ø 8 mm
Mit Führungsstift diamantiert
Fadenplatte 6x0,7 mm



Diamond Tip
Diamantiert
Punta diamantata
Punta de diamante
Pointe de diamant

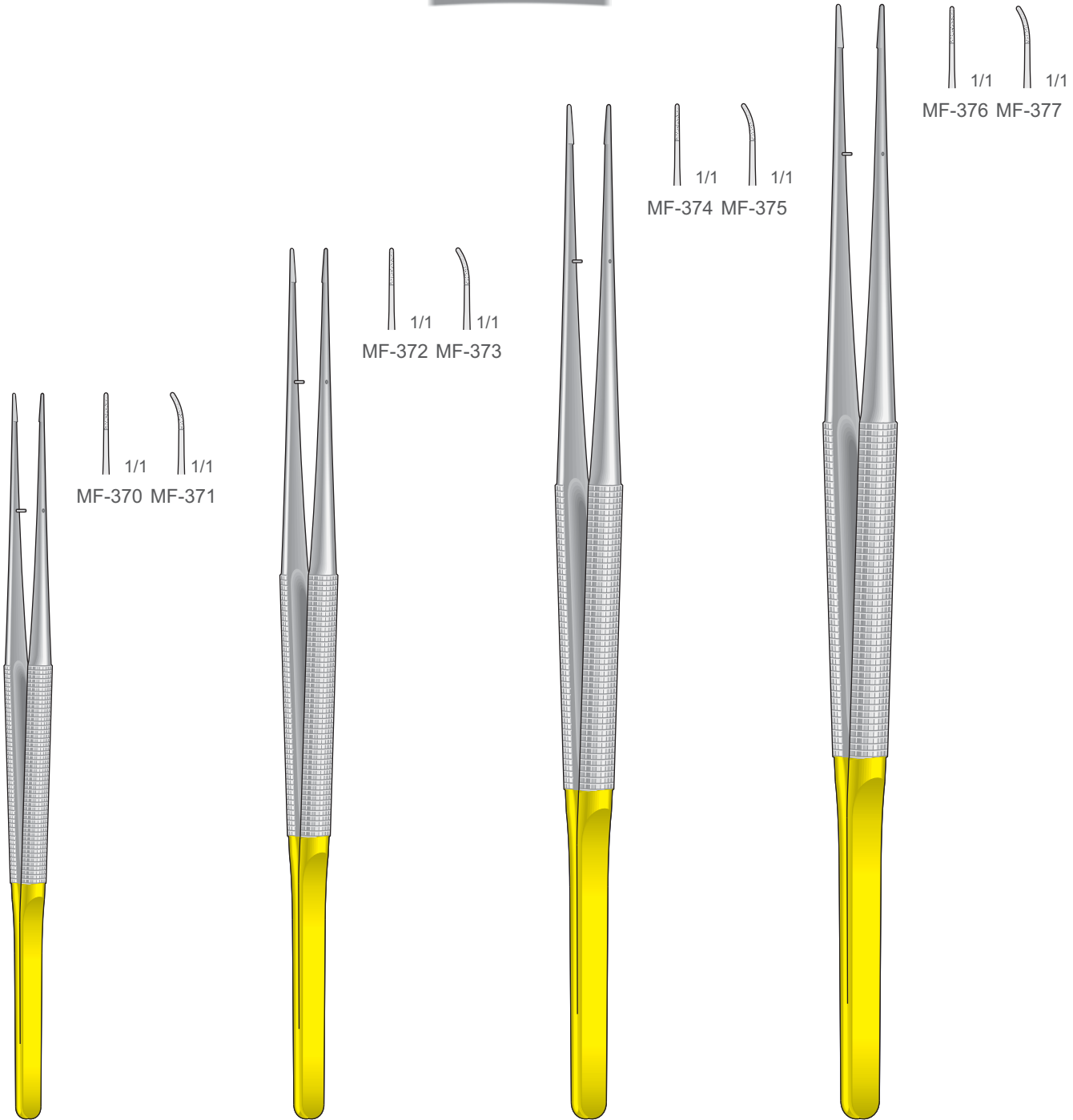

MF-370/MF-371
150 mm

MF-372/MF-373
180 mm

MF-374/MF-375
210 mm

MF-376/MF-377
230 mm



Mikro Pinzetten
Micro Forceps
Micro Pinzette
Micro Pinzas
Micro Pincas

Mikro Pinzette - Rundgriff Ø 8 mm
Mit Führungsstift diamantiert
Fadenplatte 6x0,7 mm



1x2 Zähne
1x2 Teeths
1x2 Denti
1x2 Dientes
1x2 Dents

1x2 Zähne
1x2 Teeths
1x2 Denti
1x2 Dientes
1x2 Dents

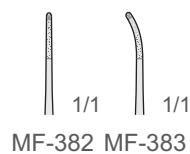
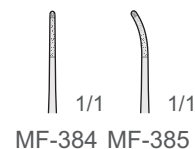

1x2 Zähne
1x2 Teeths
1x2 Denti
1x2 Dientes
1x2 Dents

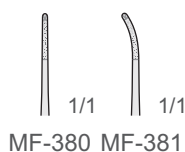

1x2 Zähne
1x2 Teeths
1x2 Denti
1x2 Dientes
1x2 Dents

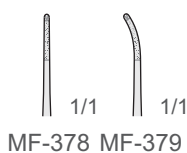

MF-378/MF-379
150 mm



MF-380/MF-381
180 mm



MF-382/MF-383
210 mm



MF-384/MF-385
230 mm



Titanium
Titan
Titane
Titanio
Titano

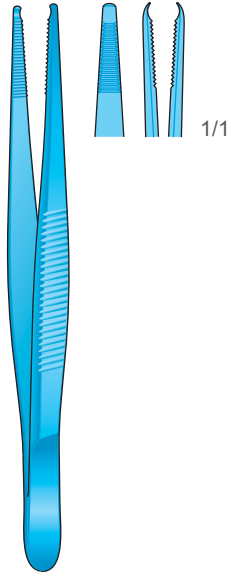

BD-285T
90 mm

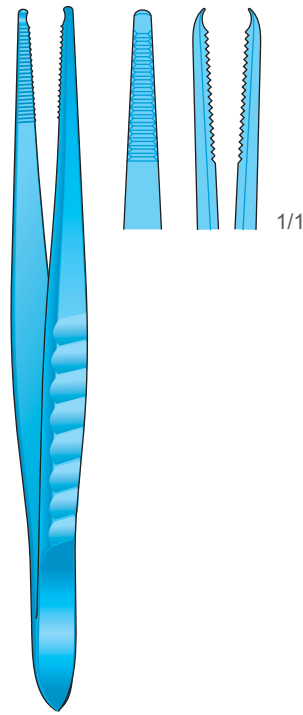

BD-270T
130 mm

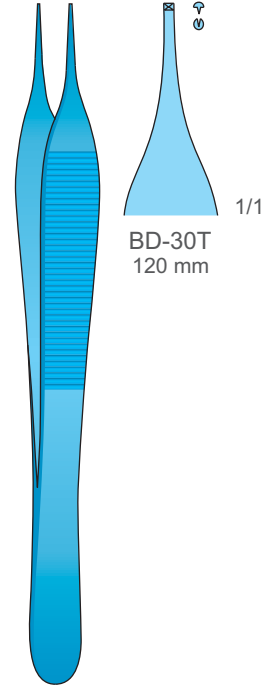

ADSON
BD-30T
120 mm

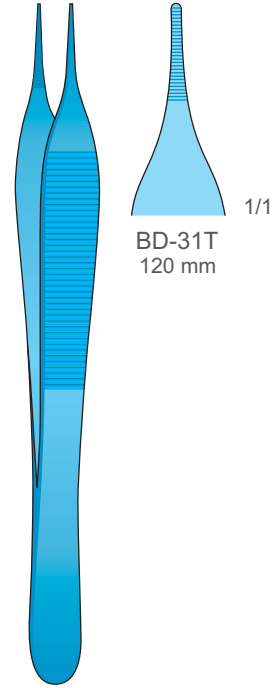

ADSON
BD-31T
120 mm

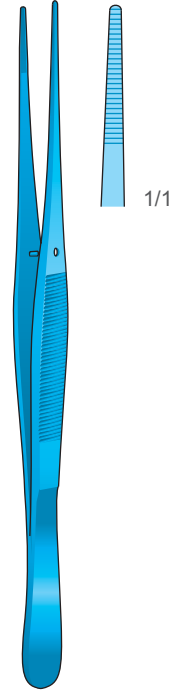

BD-09T
130 mm

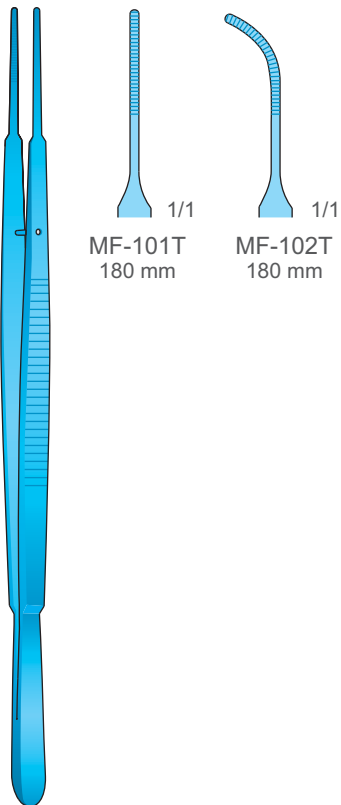

GERALD
MF-101T/MF-102T
180 mm

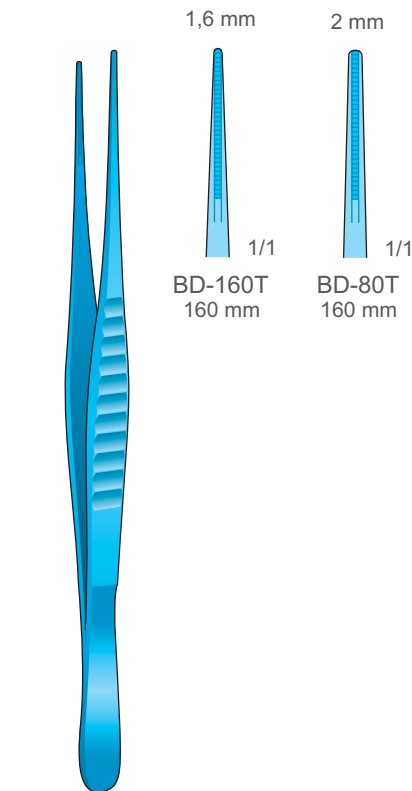

DE BAKEY
BD-80T/BD-160T

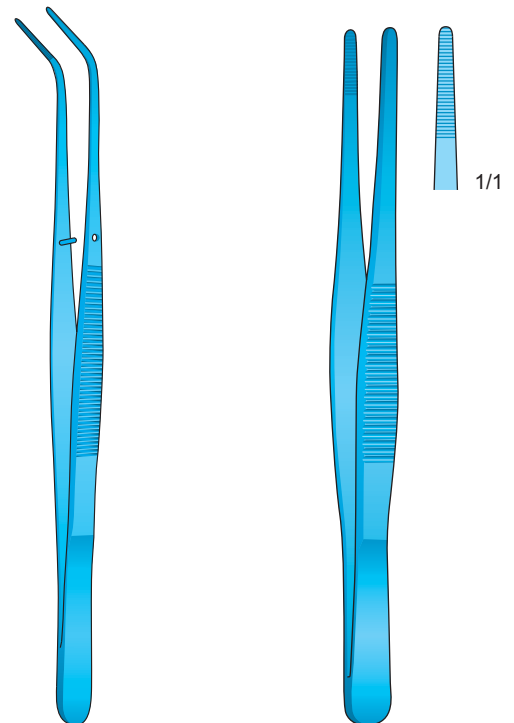

COLLEGE
TT-01
150 mm

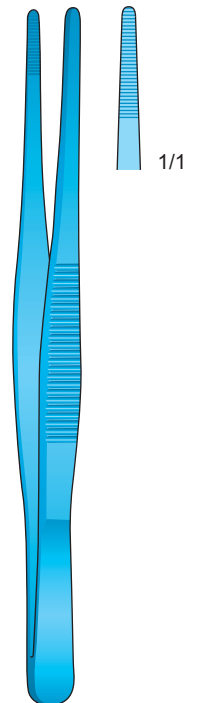

BD-75T
145 mm



Mikro Pinzetten
Delicate Forceps
Micro Pinzette
Pinzas finas
Micro Pincas

05

Rund-Griffe Ø 8 mm
Round handle Ø 8 mm
Manico rotondo Ø 8 mm
Mango redondo Ø 8 mm
Manche rond Ø 8 mm

	Ø 1 mm	Ø 2 mm	Titan Titanium Titanio Titane	Ø 1 mm	Ø 2 mm
	MF-124 - 150 mm MF-125 - 180 mm MF-126 - 210 mm	MF-127 - 150 mm MF-128 - 180 mm MF-129 - 210 mm		MF-142T - 150 mm MF-143T - 180 mm MF-144T - 210 mm	MF-145T - 150 mm MF-146T - 180 mm MF-147T - 210 mm
MF-124/MF-129					



Titanium
Titan
Titane
Titanio
Titanio

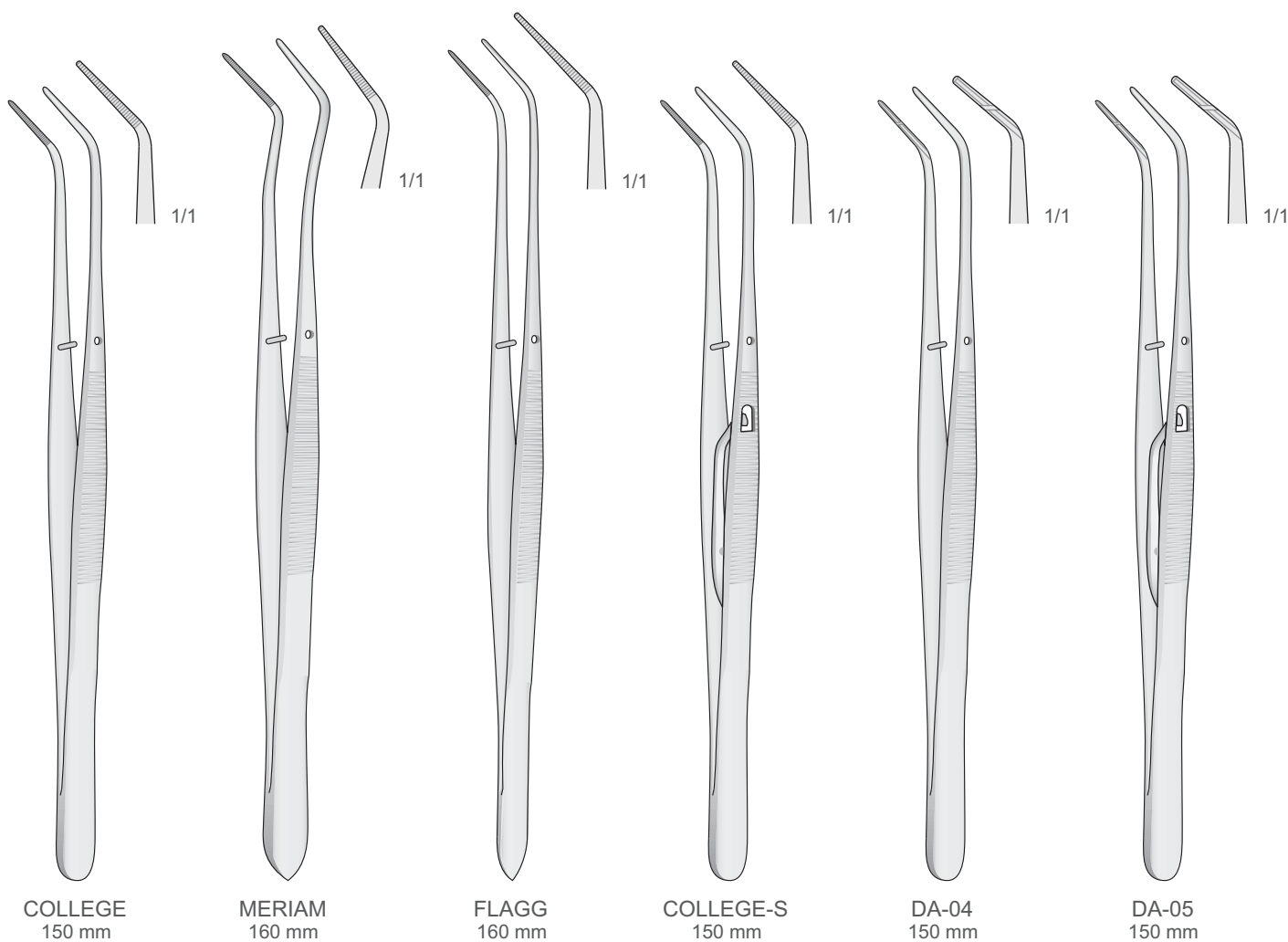



Zahnpinzetten
Cotton and Dressing Pliers
Pinzette per medicazione
Pinzas para vendajes
Précelles pour cotton

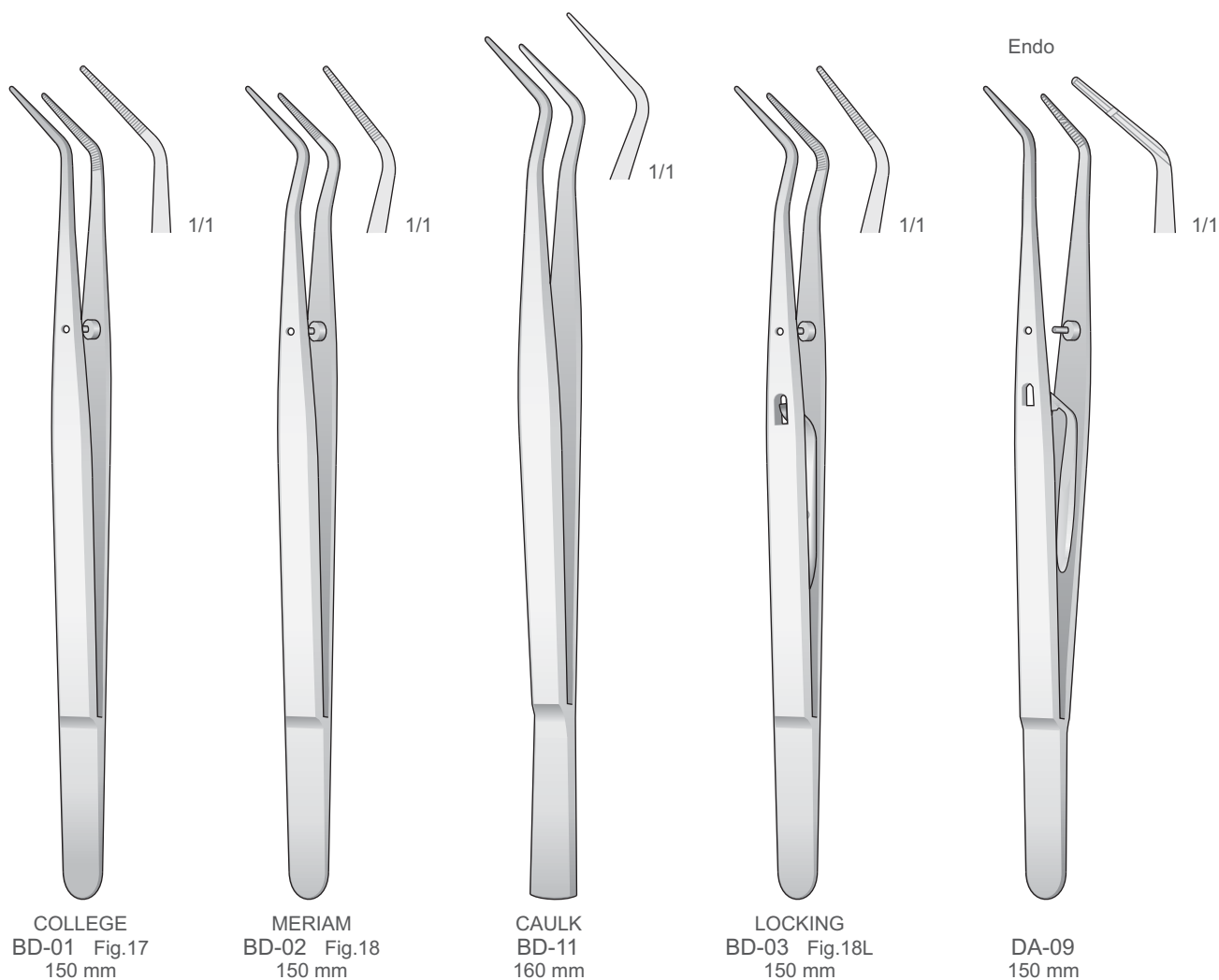

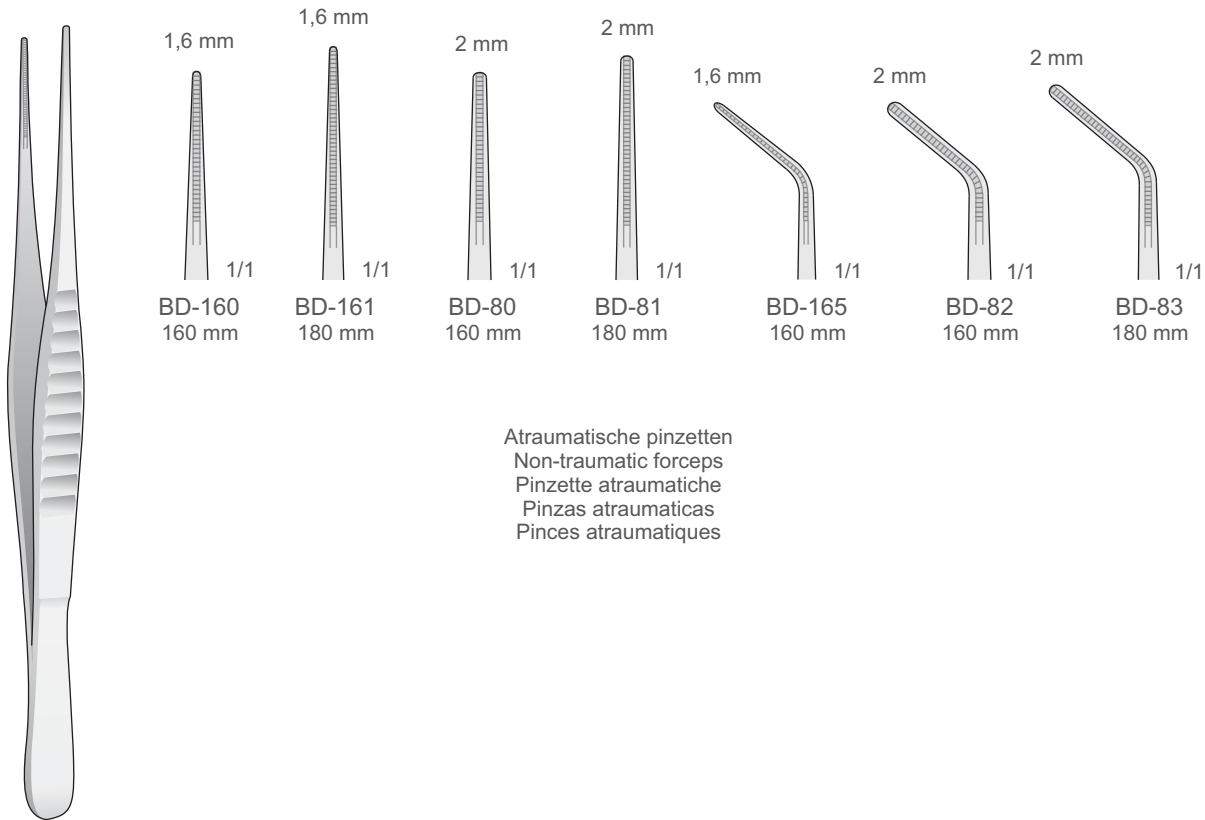

Atraumatische pinzetten
Non-traumatic forceps
Pinzette atraumatiche
Pinzas atraumaticas
Pincas atraumatiques

DE BAKEY
BD-80/BD-165

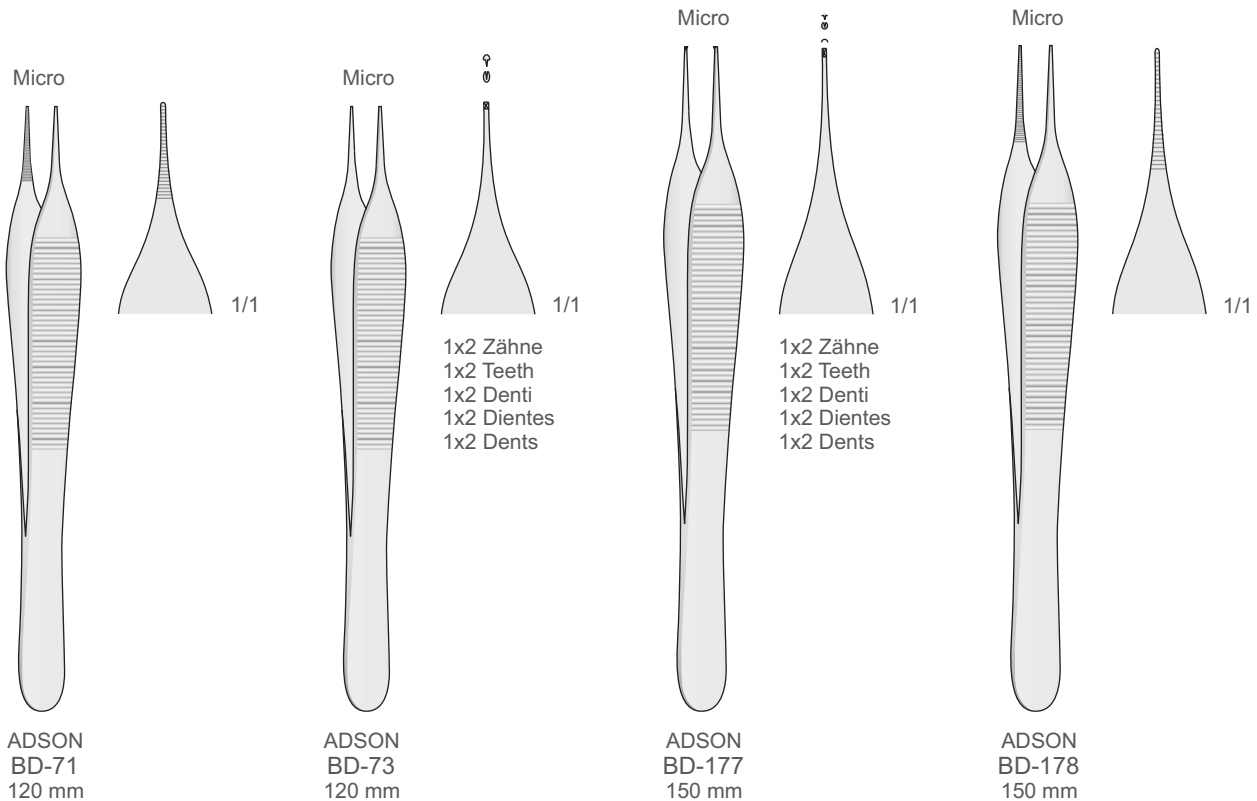



Chirurgische Pinzetten
Tissue Forceps
Pinzette chirurgiche
Pinzas quirùrgicas
Pincas quirurgicales

05

Taschenmarkierungspinzetten
Pocket markers
Pinzette segnatasche
Pinzas para marcar el sulco periodontal
Pincas à marquer la poche

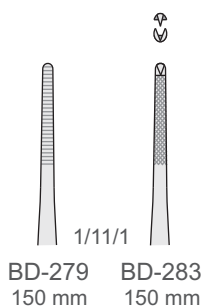
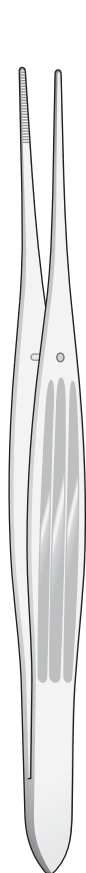

McINDOE
BD-279/BD-283
150 mm

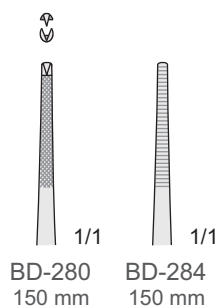

GILLIES
BD-280/BD-284
150 mm

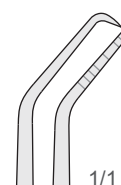
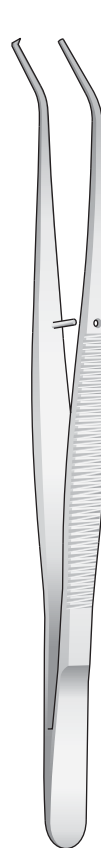

CRANE-CAPLAN
DB-01
150 mm

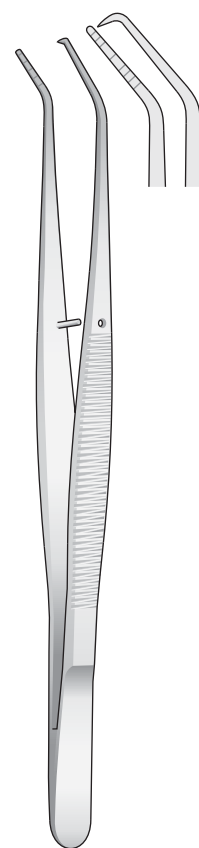

CRANE-CAPLAN
DB-02
150 mm

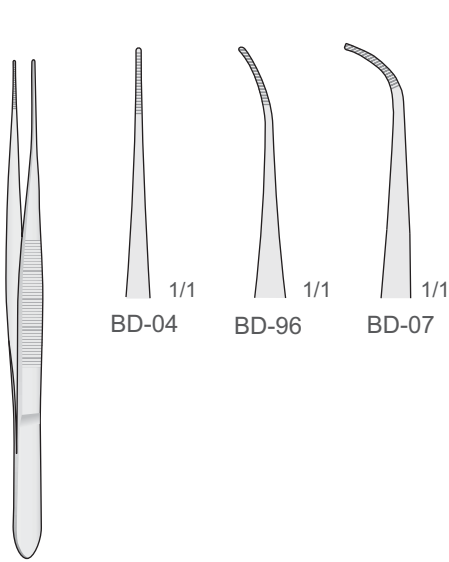

GRAEFE
BD-04/BD-96
100 mm

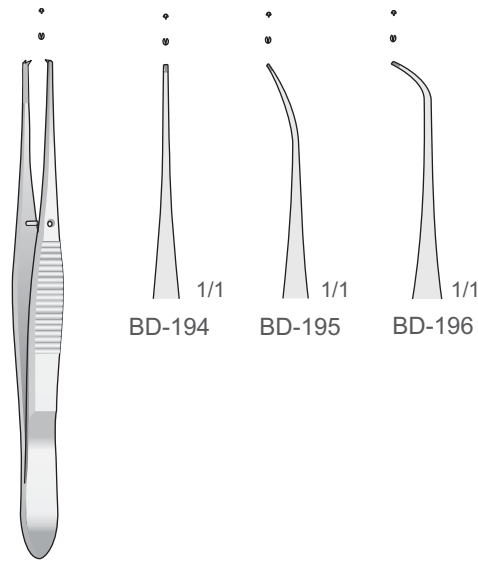

GRAEFE
BD-194/BD-196
100 mm

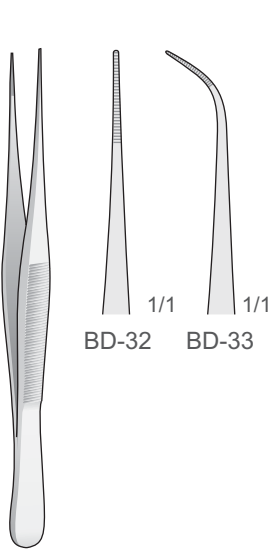

BD-32/BD-33
100 mm

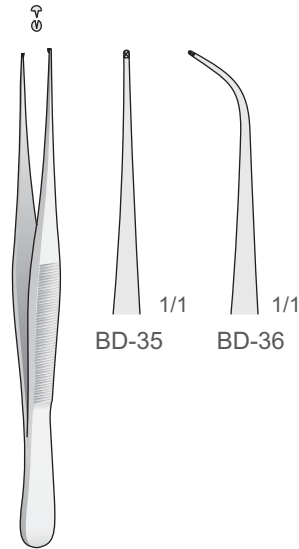

BD-35/BD-36
100 mm

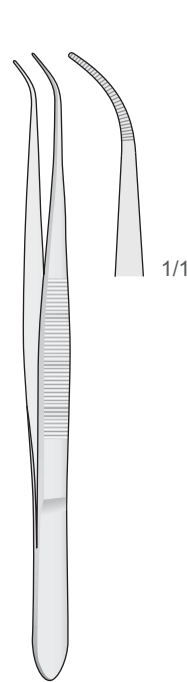

PERRY
BD-05
125 mm

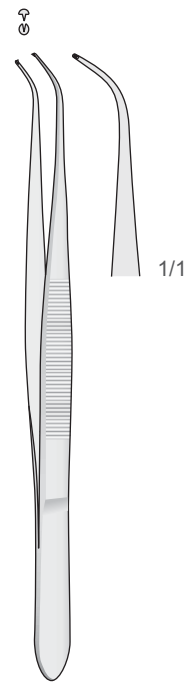

BD-06
125 mm



Anatomische Pinzetten
Dressing Forceps
Pinzette anatomiche
Pinzas de diseccion
Pinces anatomiques

05

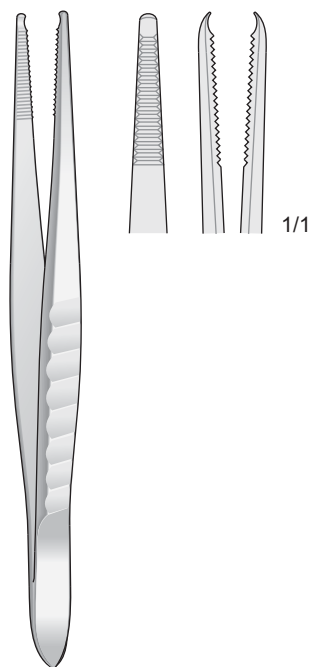

BD-270
130 mm

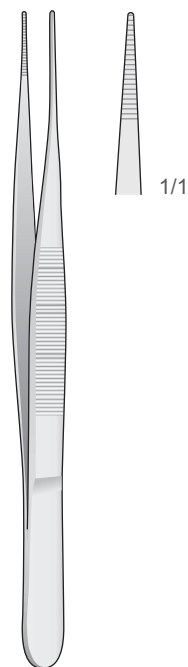

BD-145
130 mm

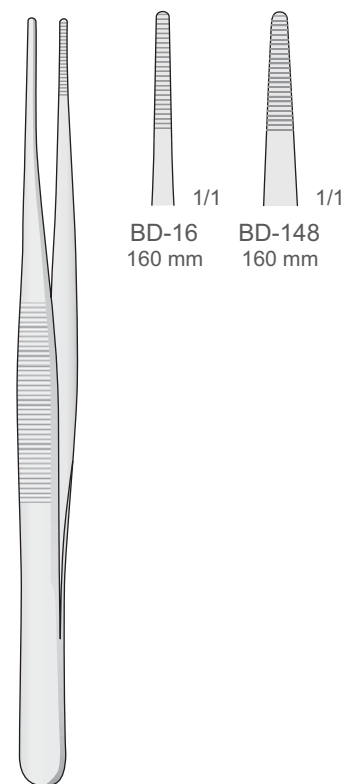

BD-16/BD-148
160 mm

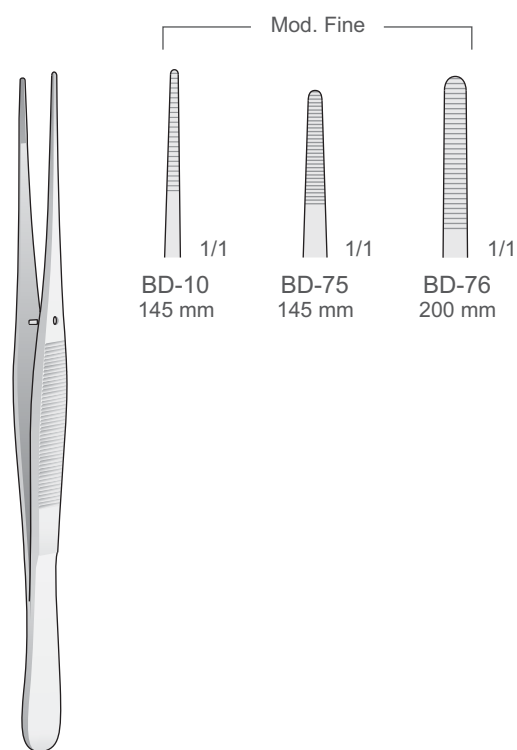

BD-10/BD-76

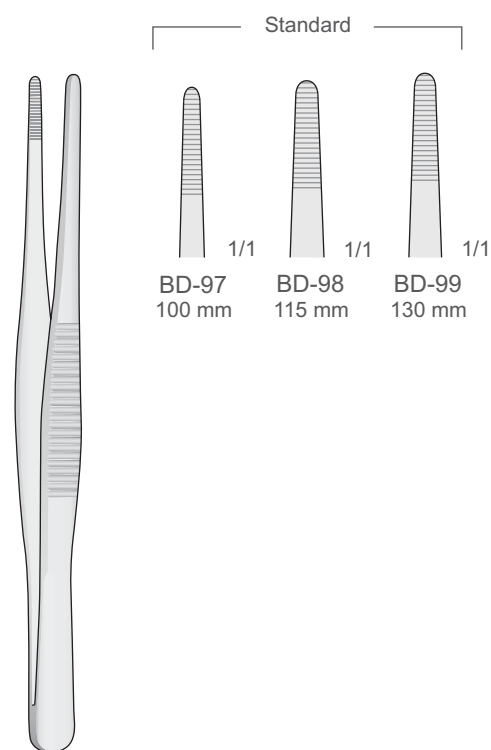

BD-97/BD-99



BD-240/BD-249

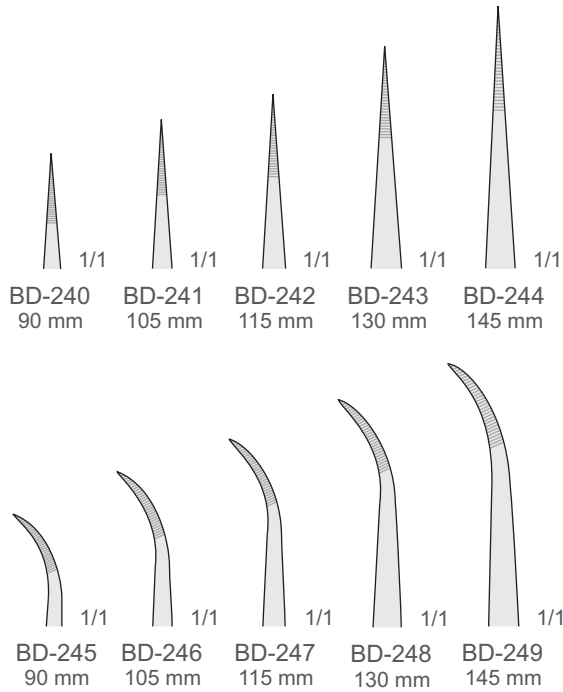

BD-60/BD-62
110 mm

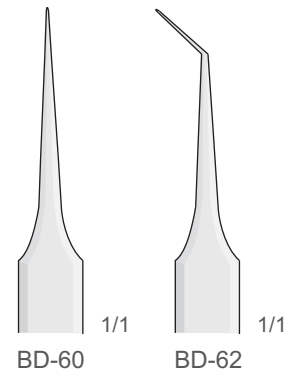

STILLE
BD-61/BD-67

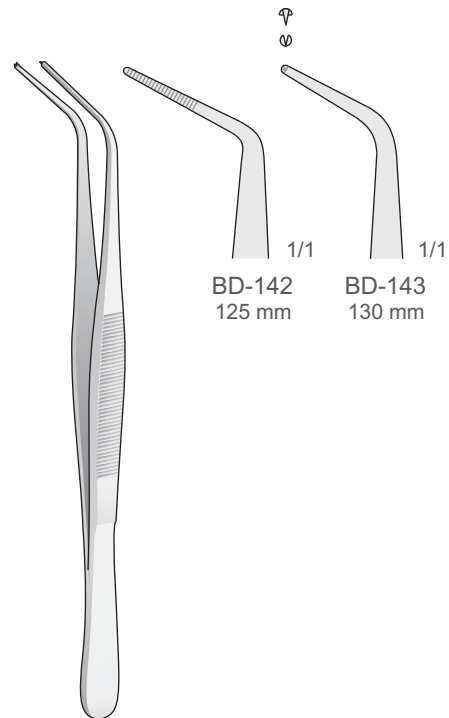
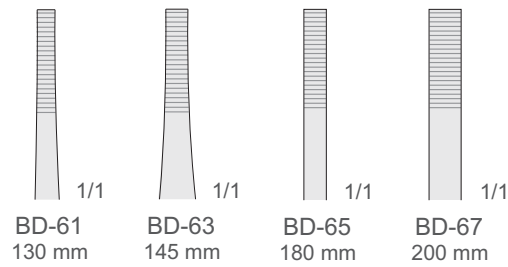

BD-142/BD-143



Chirurgische Pinzetten
Tissue Forceps
Pinzette chirurgiche
Pinzas chirùrgicas
Pincas chirurgicales

05

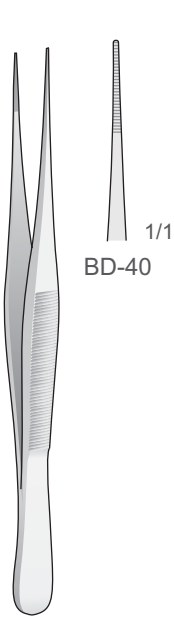

BD-40
1/1

BD-40
110 mm

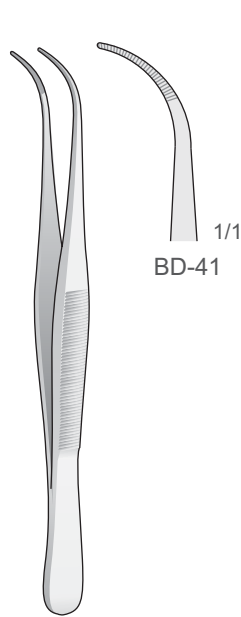

BD-41
1/1

BD-41
110 mm

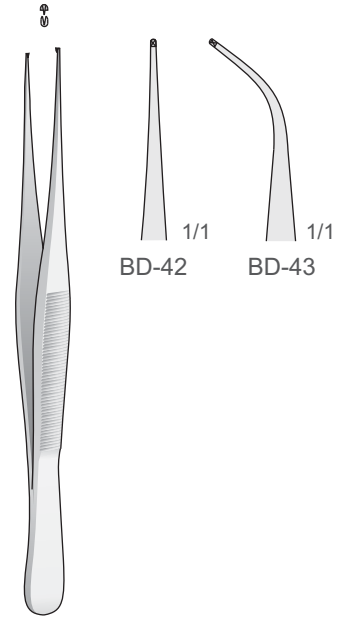

BD-42 1/1
BD-43 1/1

BD-42/BD-43
110 mm

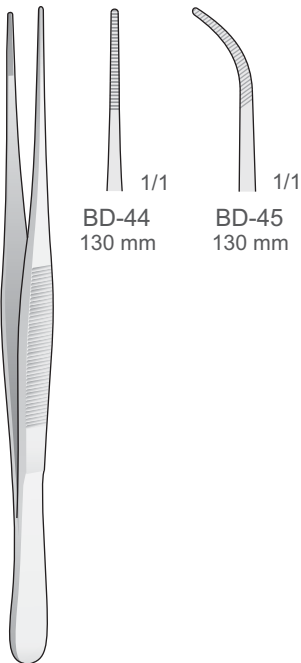

BD-44 1/1
BD-45 1/1
130 mm 130 mm

SEMKEN
BD-44/BD-45
130 mm

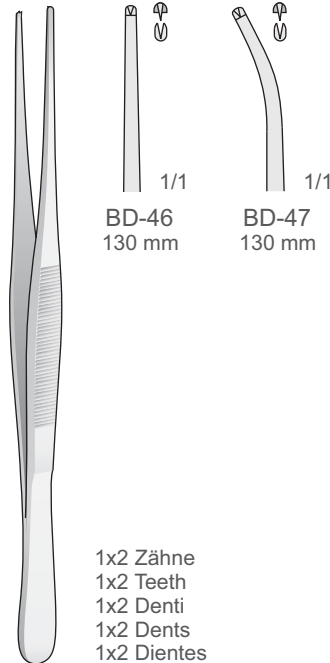

BD-46 1/1
BD-47 1/1
130 mm 130 mm

1x2 Zähne
1x2 Teeth
1x2 Denti
1x2 Dents
1x2 Dientes

SEMKEN
BD-46/BD-47
130 mm

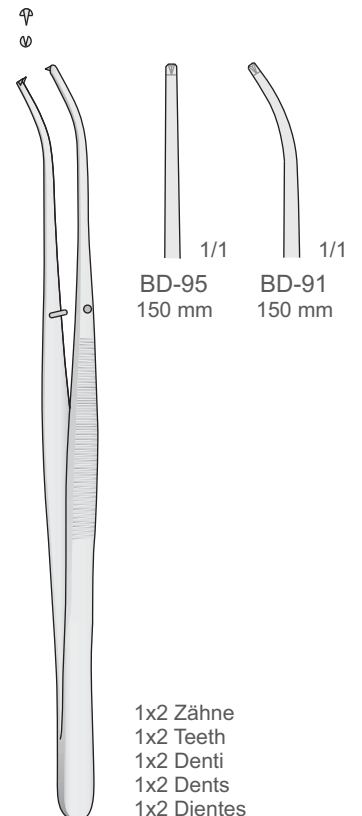

BD-95 1/1
BD-91 1/1
150 mm 150 mm

1x2 Zähne
1x2 Teeth
1x2 Denti
1x2 Dents
1x2 Dientes

SEMKEN
BD-91/BD-95
150 mm

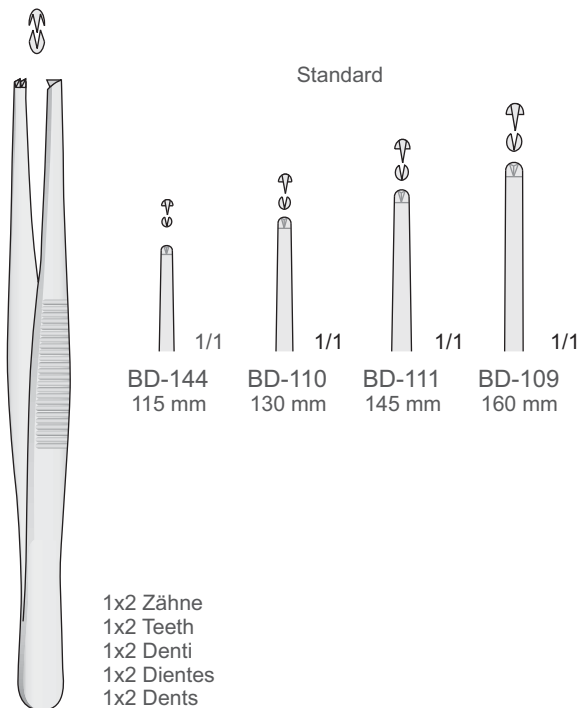

BD-109/BD-144

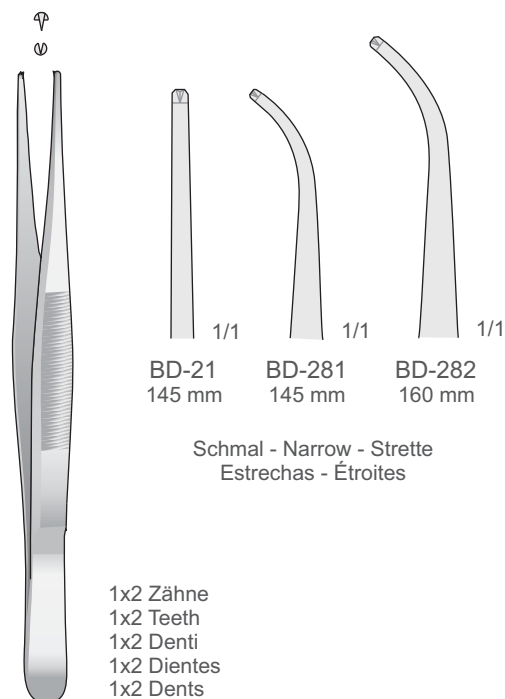

BD-21/BD-282

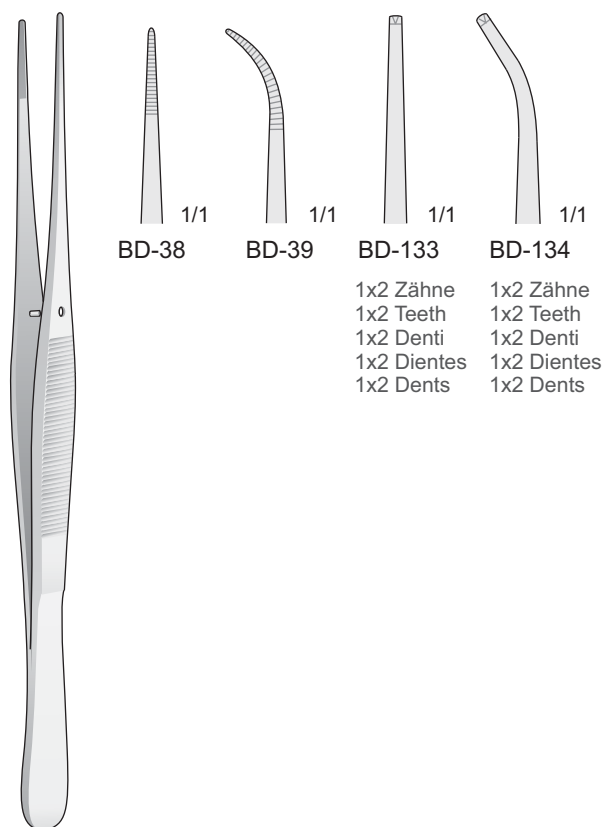

BD-38/BD-134
200 mm

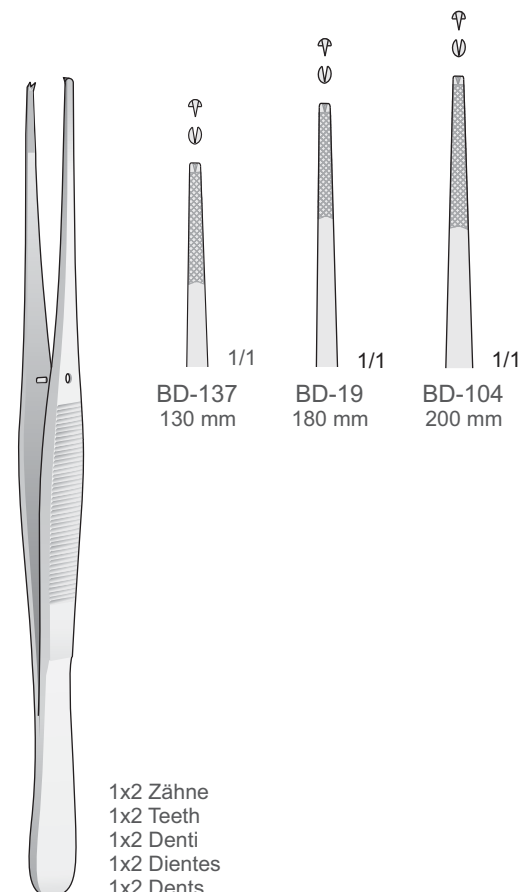

BD-19/BD-137



Chirurgische Pinzetten
Tissue Forceps
Pinzette chirurgiche
Pinzas chirùrgicas
Pincas chirurgicales

05



GERALD
MF-101
180 mm

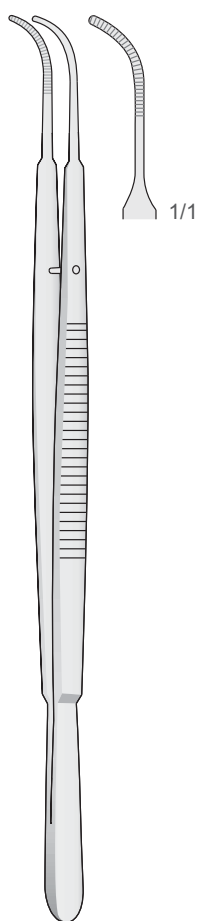

GERALD
MF-102
180 mm

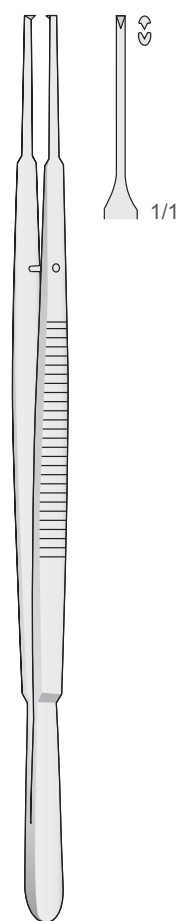

GERALD
MF-103
180 mm

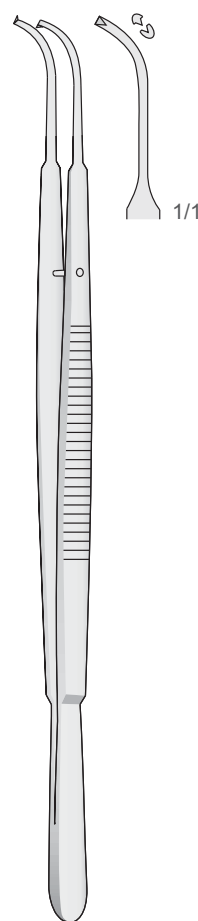

GERALD
MF-104
180 mm

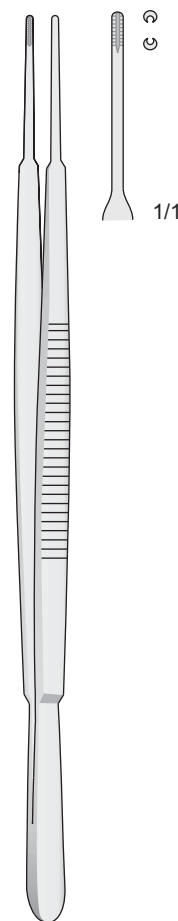

GERALD-BROWN
MF-105
180 mm

Membrane Forceps
with delicate Ring tip

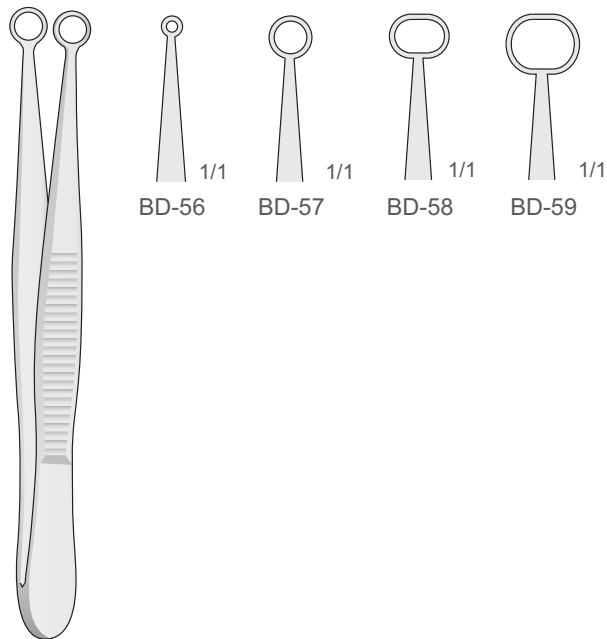

BD-56/BD-59
100 mm

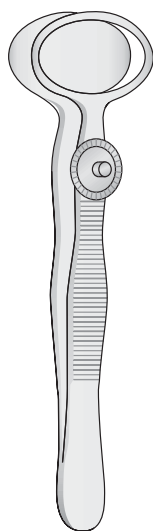

DESMARRES
BD-130/BD-131
90 mm

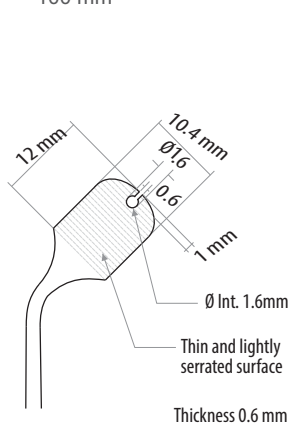
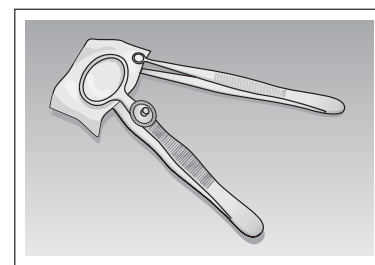
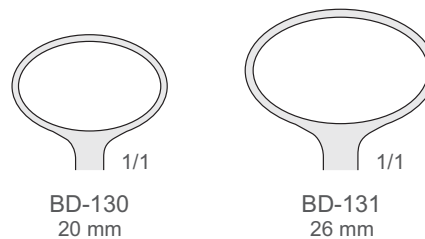

Pinzetten zum Halten Membranen
Membrane Holding forceps
Pinza per fissaggio membrane
Pinza para sostener membranas
Pince pour le maintien membranes

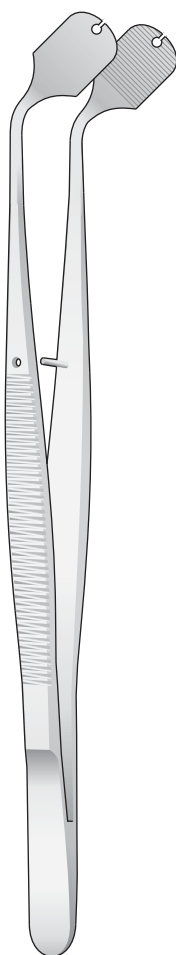

TASO-9
150 mm

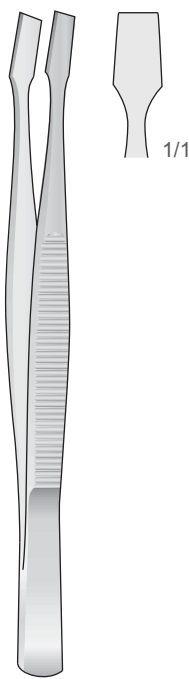

KÜHNE
ES-44

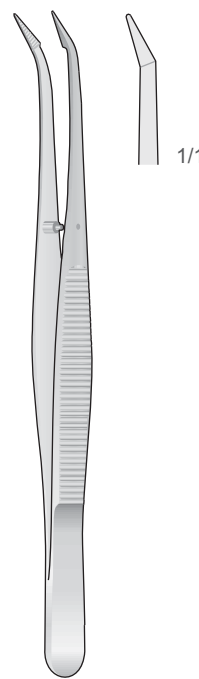

BARRAQUER
ES-65



Chirurgische Pinzetten
Tissue Forceps
Pinzette chirurgiche
Pinzas chirùrgicas
Pincas chirurgicales

05

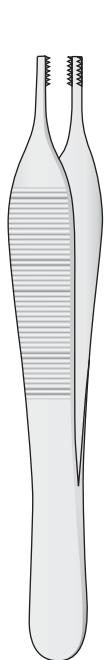

ADSON-BROWN
BD-92/BD-141
120 mm

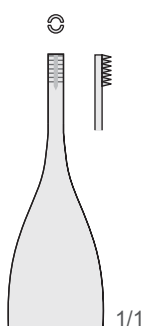

BD-92
120 mm

6x6 Zähne
6x6 Teeth
6x6 Denti
6x6 Dientes
6x6 Dents

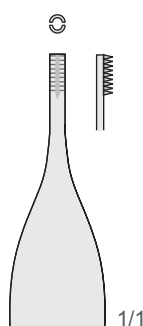

BD-141
120 mm

9x9 Zähne
9x9 Teeth
9x9 Denti
9x9 Dientes
9x9 Dents

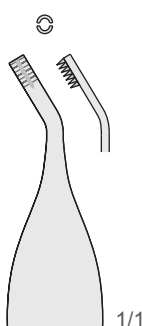

BD-93
120 mm

6x6 Zähne
6x6 Teeth
6x6 Denti
6x6 Dientes
6x6 Dents



ADSON
BD-90
120 mm

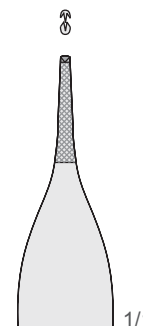

BD-90
120 mm



BROWN
BD-94
150 mm

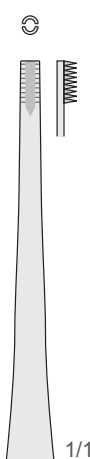

8x8 Zähne
8x8 Teeth
8x8 Denti
8x8 Dientes
8x8 Dents

Standard



ADSON
BD-380
150 mm

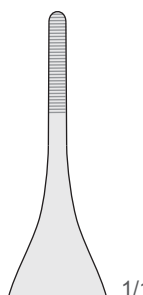

Standard



ADSON
BD-381
150 mm

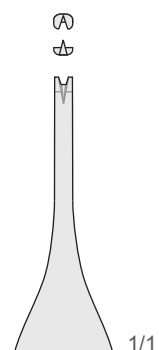

1x2 Zähne
1x2 Teeth
1x2 Denti
1x2 Dientes
1x2 Dents



ADSON-BROWN
BD-382
150 mm

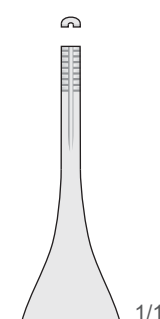

9x9 Zähne
9x9 Teeth
9x9 Denti
9x9 Dientes
9x9 Dents

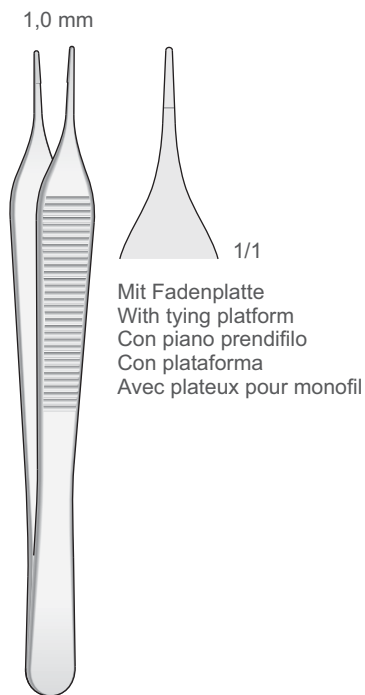

ADSON
BD-370
120 mm

Mit Fadenplatte
With tying platform
Con piano prendifilo
Con plataforma
Avec plateaux pour monofil

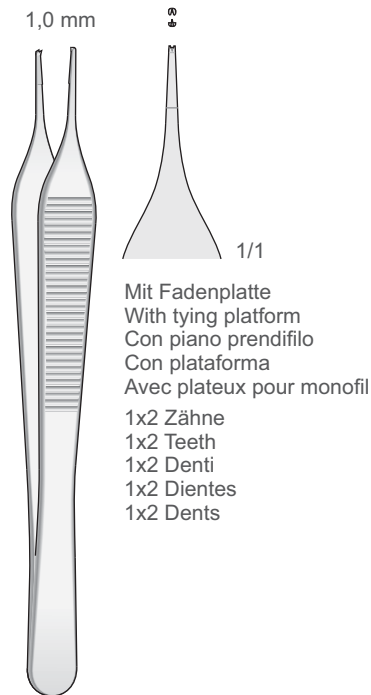

ADSON
BD-371
120 mm

Mit Fadenplatte
With tying platform
Con piano prendifilo
Con plataforma
Avec plateaux pour monofil
1x2 Zähne
1x2 Teeth
1x2 Denti
1x2 Dientes
1x2 Dents

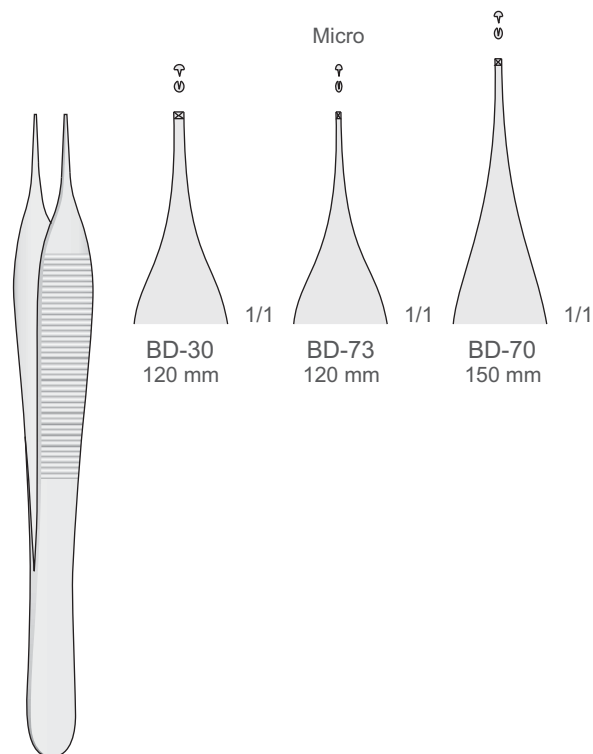

ADSON
BD-30/BD-73

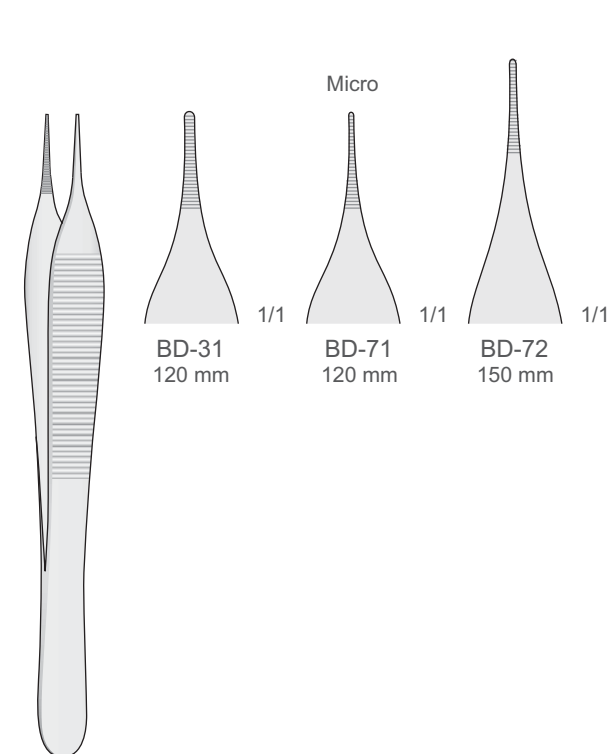

ADSON
BD-31/BD-72



Chirurgische Pinzetten - Anatomische Pinzetten
Tissue Forceps - Dressing forceps
Pinzette chirurgiche - Pinzette anatomiche
Pinzas chirùrgicas - Pinzas de diseccion
Pincas chirurgicales - Pincas anatomiques

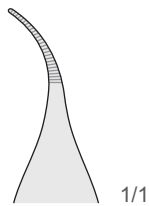

Extra fein
Extra fine
Extra fine
Extra finas
Extra fins

Gebogen
Curved
Curva
Curvas
Courbé

MICRO-ADSON
BD-372
120 mm

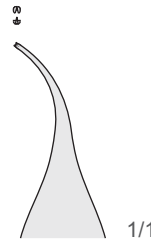

Extra fein
Extra fine
Extra fine
Extra finas
Extra fins

Gebogen
Curved
Curva
Curvas
Courbé

1x2 Zähne
1x2 Teeth
1x2 Denti
1x2 Dientes
1x2 Dents

MICRO-ADSON
BD-373
120 mm

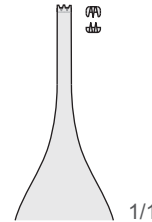

2x3 Zähne
2x3 Teeth
2x3 Denti
2x3 Dientes
2x3 Dents

ADSON
BD-377
120 mm

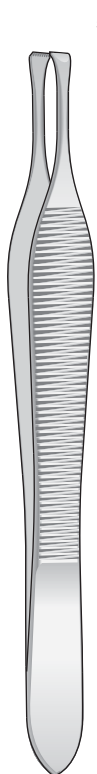

BEASLEY-BABCOCK
BD-51
120 mm



GRAEFE
BD-135
110 mm

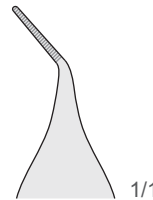

Gerieft
Serrated
Zigrinata
Estrizada
Striée

Abgewinkelt
Angled
Angolata
Angulada
Coudée en haut

ADSON
BD-378
120 mm

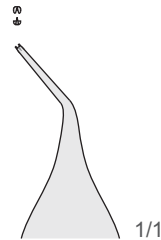

1x2 Zähne
1x2 Teeth
1x2 Denti
1x2 Dientes
1x2 Dents

Abgewinkelt
Angled
Angolata
Angulada
Coudée en haut

ADSON
BD-379
120 mm

Chirurgische Pinzetten - Anatomische Pinzetten
Tissue Forceps - Dressing forceps
Pinzette chirurgiche - Pinzette anatomiche
Pinzas quirùrgicas - Pinzas de diseccion
Pincas chirurgicales - Pincas anatomiques



BD-09/BD-20

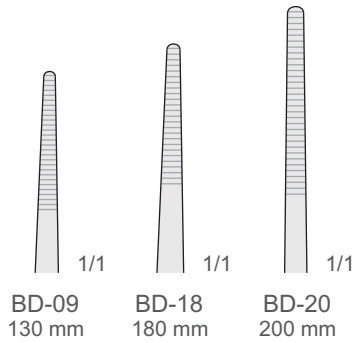

BD-23/BD-26

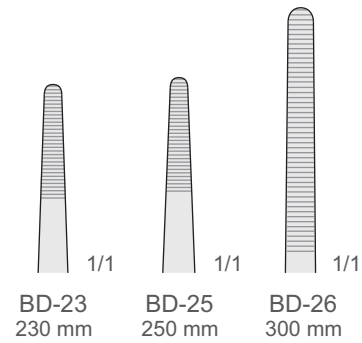

BD-271/BD-276

1x2 Zähne
1x2 Teeth
1x2 Denti
1x2 Dientes
1x2 Dents

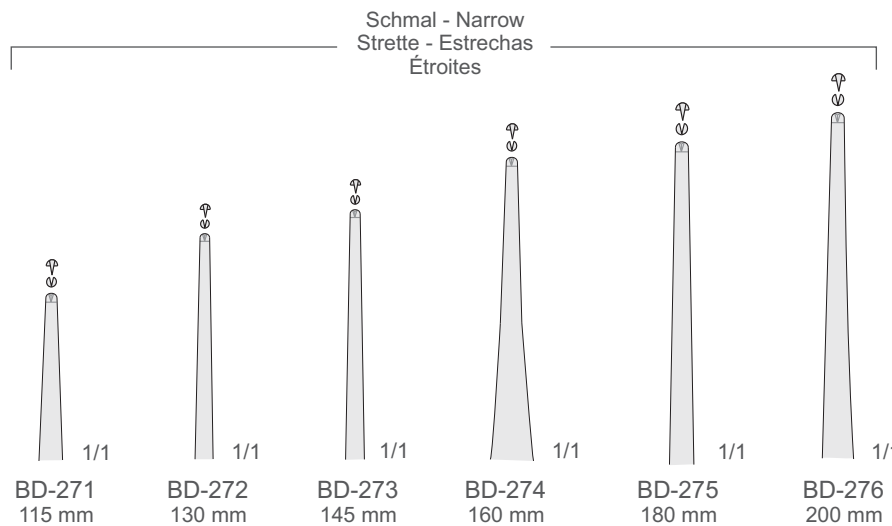



Chirurgische Pinzetten
Tissue Forceps
Pinzette chirurgiche
Pinzas chirùrgicas
Pincas chirurgicales

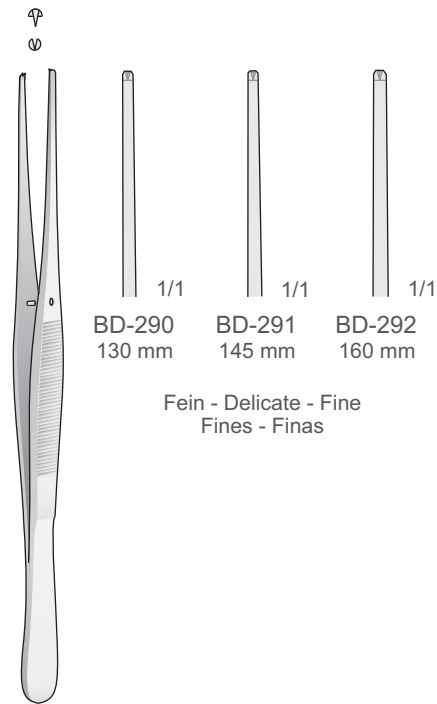

BD-290/BD-292

Fein - Delicate - Fine
Fines - Finas

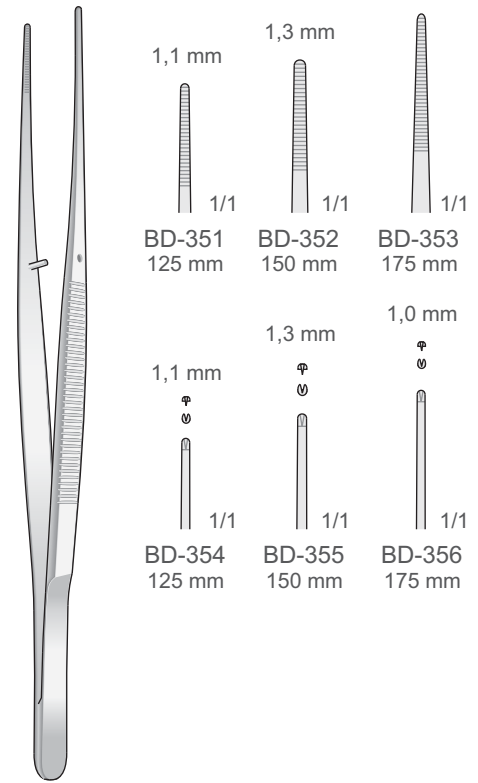

BD-351/BD-356

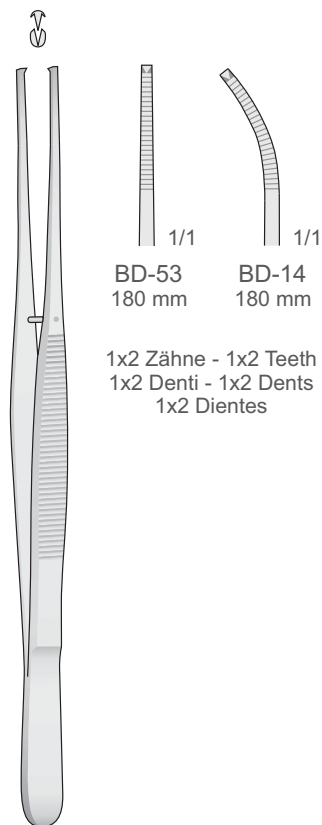

POTTS-SMITH
BD-14/BD-53
180 mm

1x2 Zähne - 1x2 Teeth
1x2 Denti - 1x2 Dents
1x2 Dientes

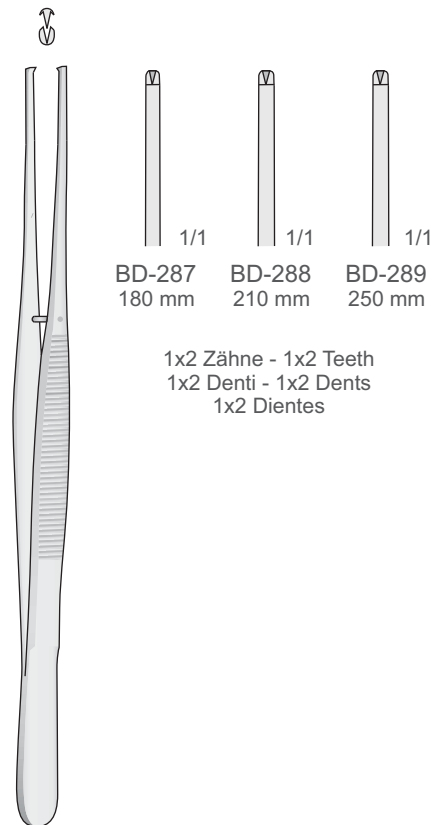

POTTS-SMITH
BD-287/BD-289

1x2 Zähne - 1x2 Teeth
1x2 Denti - 1x2 Dents
1x2 Dientes

Chirurgische Pinzetten, Atraumatische Pinzetten
Tissue Forceps, Non-traumatic Forceps
Pinzette chirurgische, Pinzette atraumatische
Pinzas quirùrgicas, Pinzas atraumáticas
Pincas chirurgicales, Pincas atraumatiques

TC

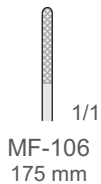

GERALD
MF-106/MF-107
175 mm



Tungsten-Carbide Inserts
Mit Hartmetalleinsätzen
Plaquettes en carbure de tungstène
Plaquetas de carburo de tungsteno
Inserti in carburo di tungsteno

TC

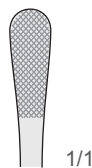

WANGENSTEEN
BD-232
150 mm

TC

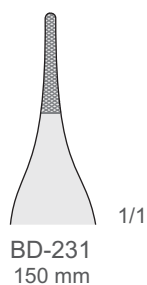
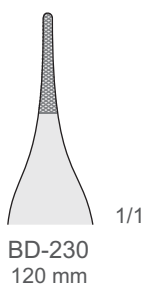
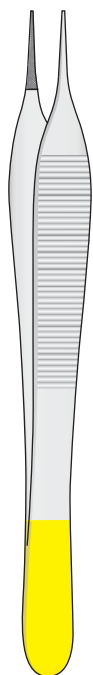

ADSON
BD-230/BD-231

TC

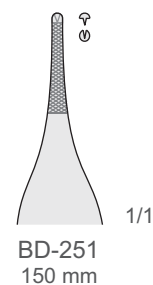
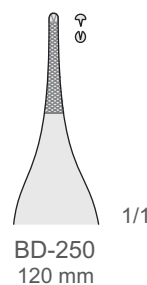
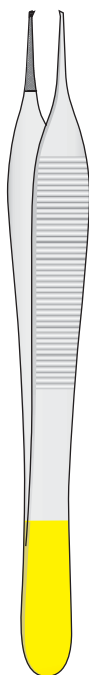

1x2 Zähne
1x2 Teeth
1x2 Denti
1x2 Dientes
1x2 Griffes

1x2 Zähne
1x2 Teeth
1x2 Denti
1x2 Dientes
1x2 Griffes

ADSON
BD-250/BD-251



Chirurgische Pinzetten, Atraumatische Pinzetten
Tissue Forceps, Non-traumatic Forceps
Pinzette chirurgiche, Pinzette atraumatiche
Pinzas quirùrgicas, Pinzas atraumàticas
Pincès chirurgicales, Pincès atraumatiques

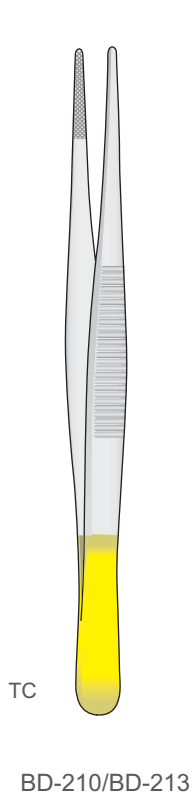

Standard

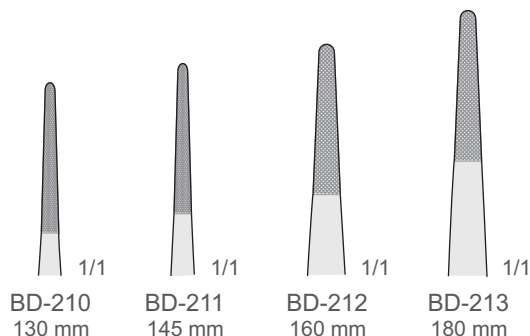

TC

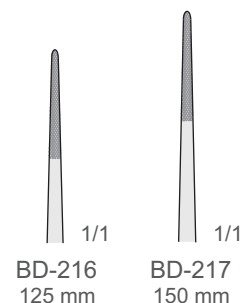

TC
TUNGSTEN
CARBIDE

Tungsten-Carbide Inserts
Mit Hartmetalleinsätzen
Plaquettes en carbure de tungstène
Plaquetas de carburo de tungsteno
Inserti in carburo di tungsteno

SEMKEN
BD-216/BD-217

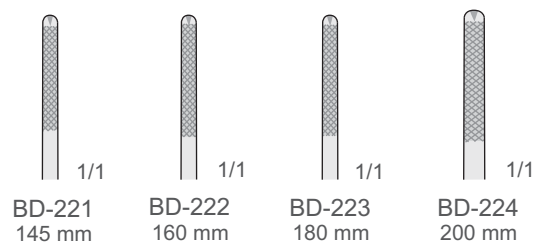
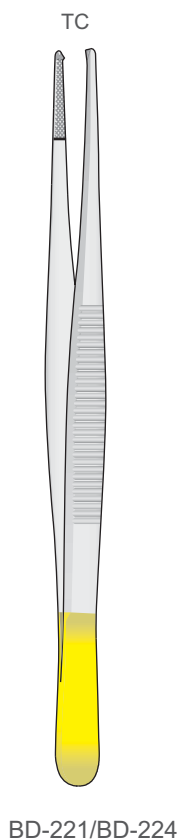

TC



DE BAKEY
BD-267
160 mm

Naht-und Membranpinzette - Suture and membrane Forceps
Pinzette per suture e membrane - Pinzas para suturas y membranas
Pincettes à suture et à membrane

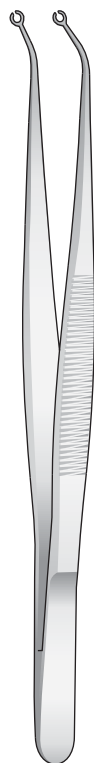

Ø Int 1.6 mm
1/1
BD-158
Ø Int 2.2 mm
1/1
BD-159

BD-158/BD-159
160 mm

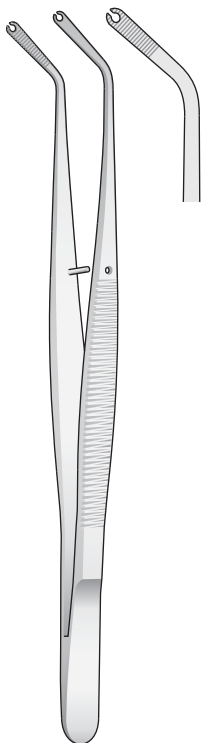

CORN
DA-07
150 mm



DA-06
150 mm

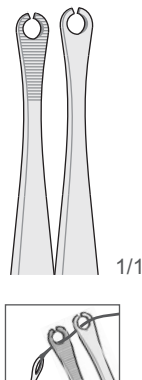

DA-08
150 mm

Artikulationspapier-Pinzetten - Articulating Paper Forceps
Pinza per carta articolazione - Pinzas para papel de articular
Pince pour papier à articuler



RUSSIAN
BD-27/BD-175

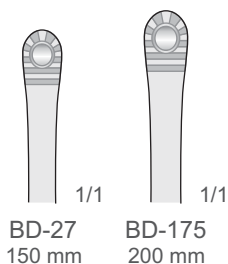

BD-27 150 mm
BD-175 200 mm



MILLER
DR-78
145 mm

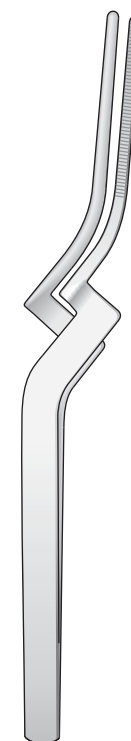
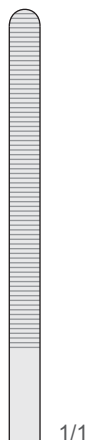

MILLER
DR-80
160 mm

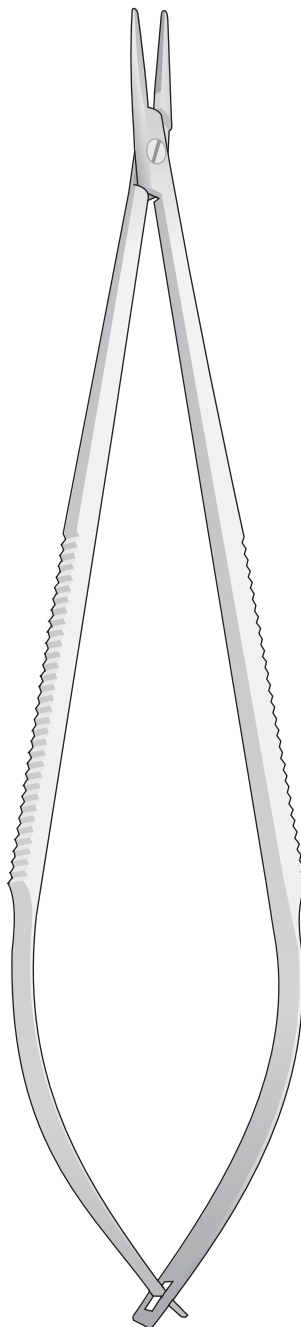

06 |

Needle Holders
Nadelhalter
Porte-aiguilles
Porta-agujas
Port'aghi



Nadelhalter
Needle Holders
Port'aghi
Portaagujas
Porte aiguilles

Mit Scheren
With Scissor
Con forbice
Con tijeras
Avec ciseaux

Glattes Maul
Smooth Jaw
Morso liscio
Mandíbula lisa
Mors lisse

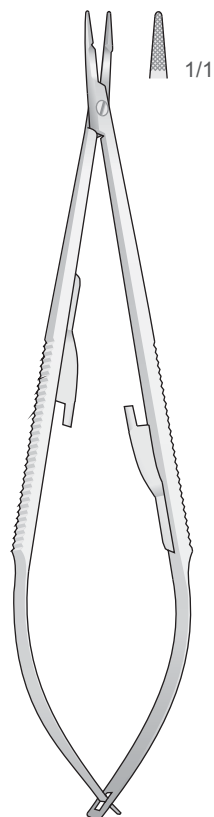

FD-26
140 mm

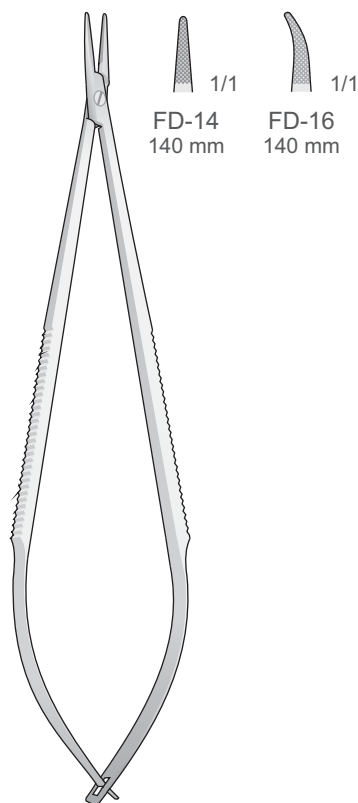

FD-14/FD-16
140 mm

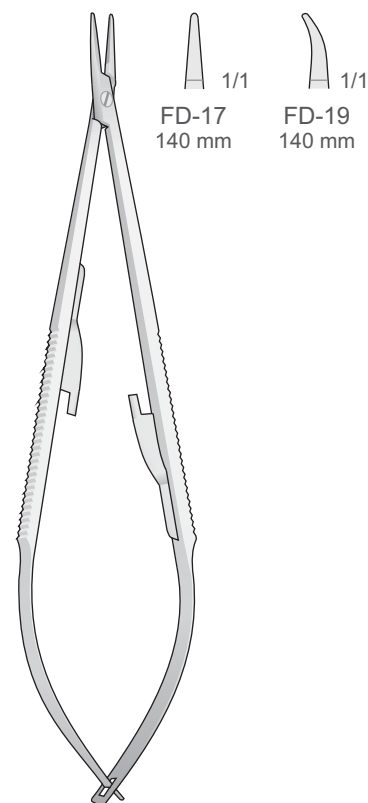

CASTROVIEJO
FD-17/FD-19
140 mm

Mit Locking-System
With Locking System (stop)
Con sistema di bloccaggio
Con sistema de bloqueo
Avec système de verrouillage

Glattes Maul
Smooth Jaw
Morso liscio
Mandibula lisa
Mors lisse

Feingerieftes Maul
Fine serrated jaws
Morso zigrinato fine
Mandibula estriada fina
Mors strié fin

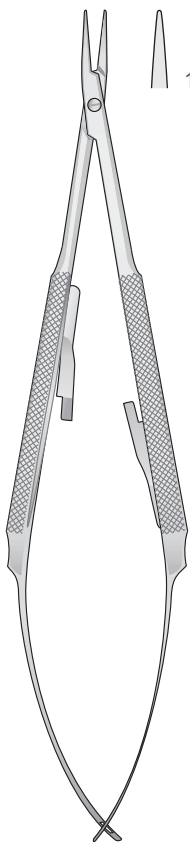

BARRAQUER
FD-216
150 mm

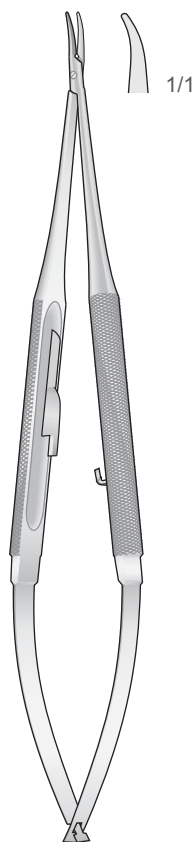

BARRAQUER
FD-217
150 mm

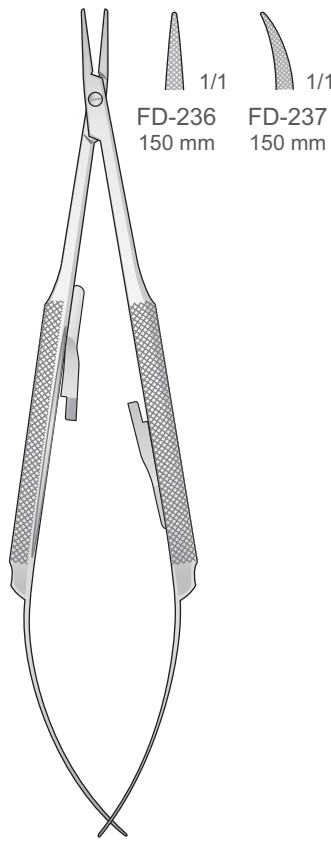

BARRAQUER
FD-236/FD-237
150 mm

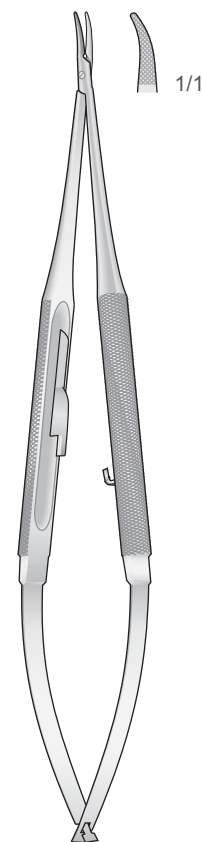

BARRAQUER
FD-24
150 mm



Nadelhalter
Needle Holders
Port'aghi
Portaagujas
Porte aiguilles

06



Tungsten-Carbide Inserts
Mit Hartmetalleinsätzen
Plaquettes en carbure de tungstène
Plaquetas de carburo de tungsteno
Inserti in carburo di tungsteno

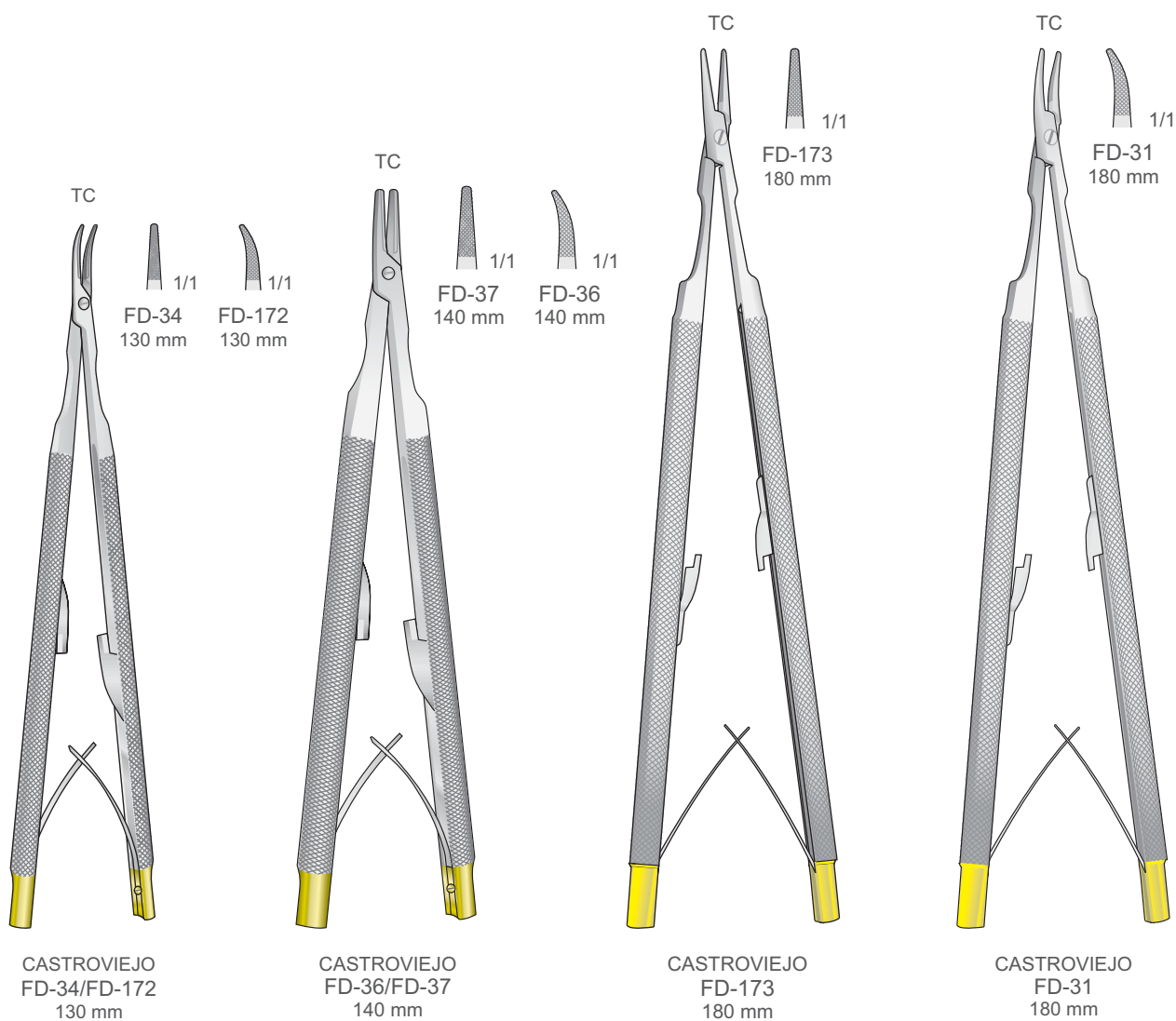



Tungsten-Carbide Inserts
Mit Hartmetalleinsätzen
Plaquettes en carbure de tungstène
Plaquetas de carburo de tungsteno
Inserti in carburo di tungsteno

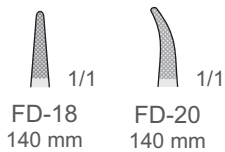
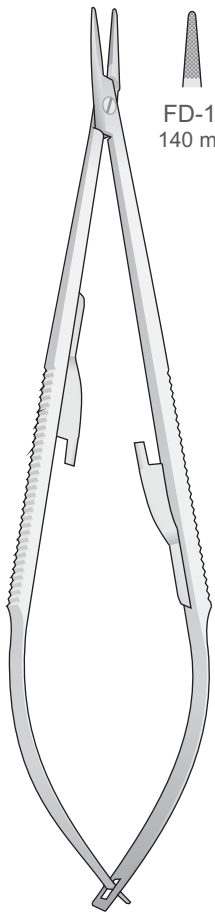

CASTROVIEJO
FD-18/FD-20
140 mm

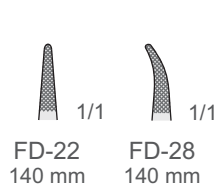
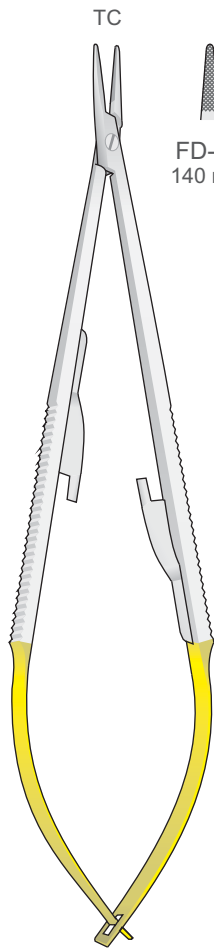

CASTROVIEJO
FD-22/FD-28
140 mm

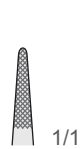
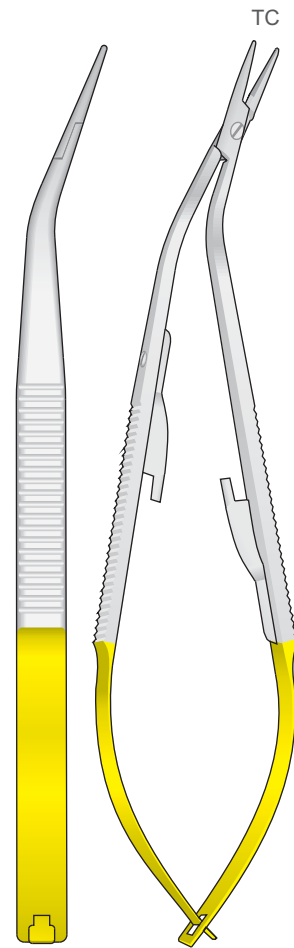

CASTROVIEJO Mod.
FD-22A
140 mm



Nadelhalter
Needle Holders
Port'aghi
Portaagujas
Porte aiguilles



Tungsten-Carbide Inserts
Mit Hartmetalleinsätzen
Plaquettes en carbure de tungstène
Plaquetas de carburo de tungsteno
Inserti in carburo di tungsteno

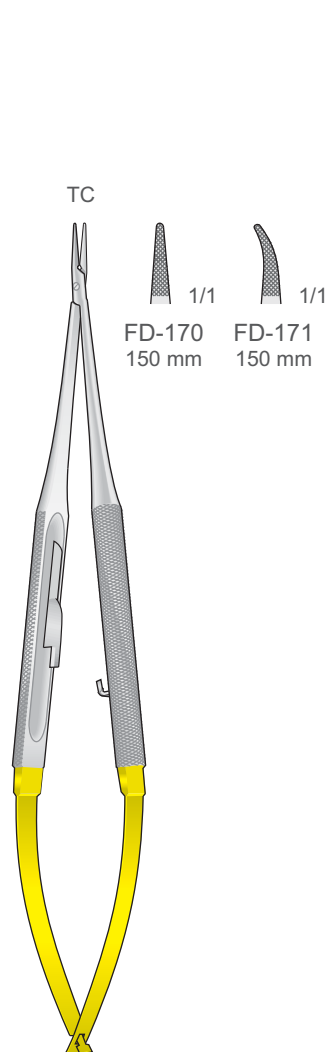

JACOBSON
FD-170/FD-171
150 mm

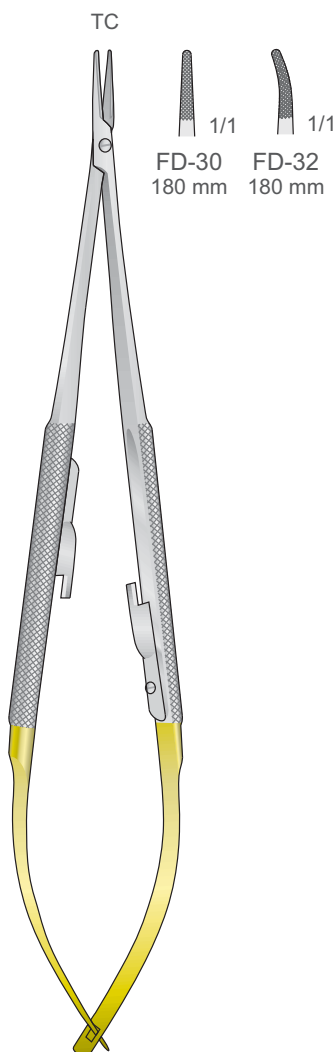

JACOBSON
FD-30/FD-32
180 mm

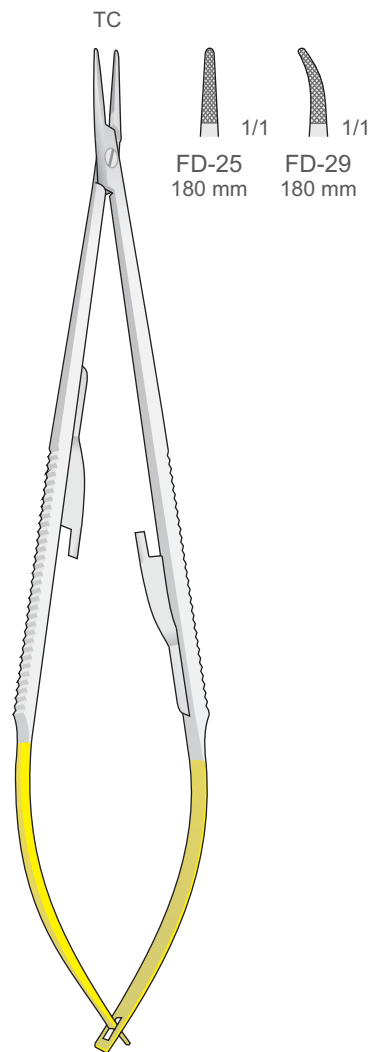

CASTROVIEJO
FD-25/FD-29
180 mm



Tungsten-Carbide Inserts
Mit Hartmetalleinsätzen
Plaquettes en carbure de tungstène
Plaquettes de carburo de tungsteno
Inserti in carburo di tungsteno

Glattes Maul
Smooth jaws
Con morso liscio
Mandibula lisa
A' mors lisse

TC

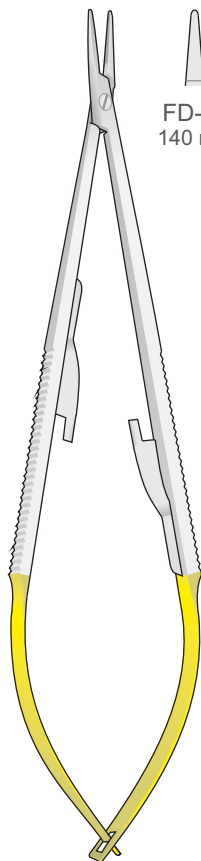
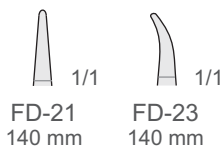

CASTROVIEJO
FD-21/FD-23
140 mm



Diamond Tip
Diamantiert
Punta diamantata
Punta de diamante
Pointe de diamant

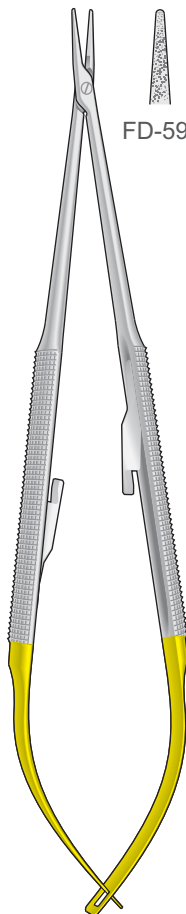
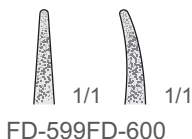

FD-599/FD-600
150 mm

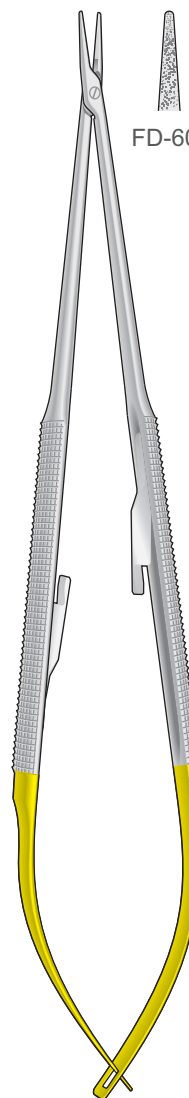
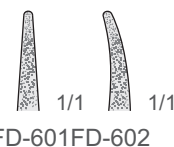

FD-601/FD-602
180 mm



Mikro Nadelhalter - Mikro Scheren
Micro Needle Holders - Micro Scissors
Micro Port'aghi - Micro Forbici
Micro Portaagujas - Micro Tijeras
Micro Porte aiguilles - Micro Ciseaux



Rund-Griffe Ø 8 mm
Round handle Ø 8 mm
Manico rotondo Ø 8 mm
Mango redondo Ø 8 mm
Manche rond Ø 8 mm

Mikro Nadelhalter
Micro Needle Holders
Micro port'aghi
Micro portaagujas
Micro porte aiguilles

Mikro Scheren
Micro Scissors
Micro forbici
Micro tijeras
Micro ciseaux

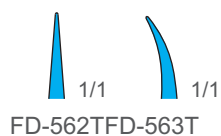
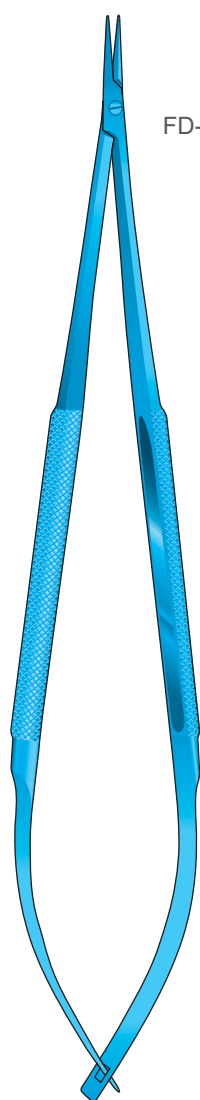

FD-562T/FD-563T
180 mm

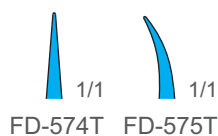
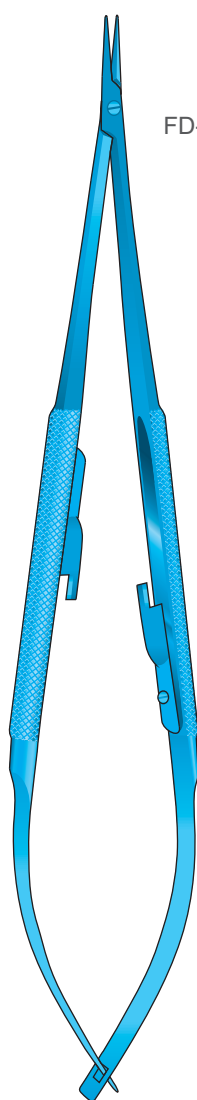

FD-574T/FD-575T
180 mm

Mit Sperre
With Lock
Con arresto
Con cierre
Avec Arrêt

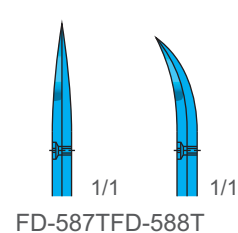
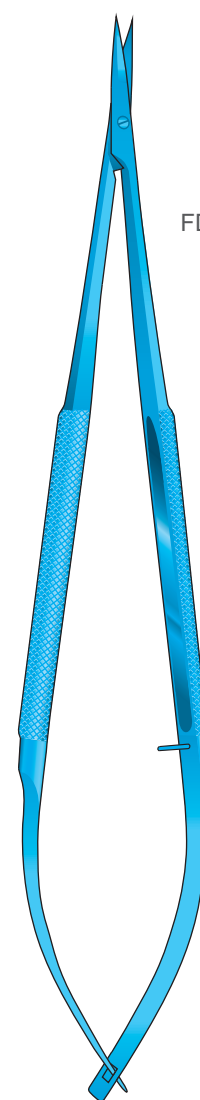

FD-587T/FD-588T
180 mm



Tungsten-Carbide Inserts
Mit Hartmetalleinsätzen
Plaquettes en carbure de tungstène
Plaquetas de carburo de tungsteno
Inserti in carburo di tungsteno

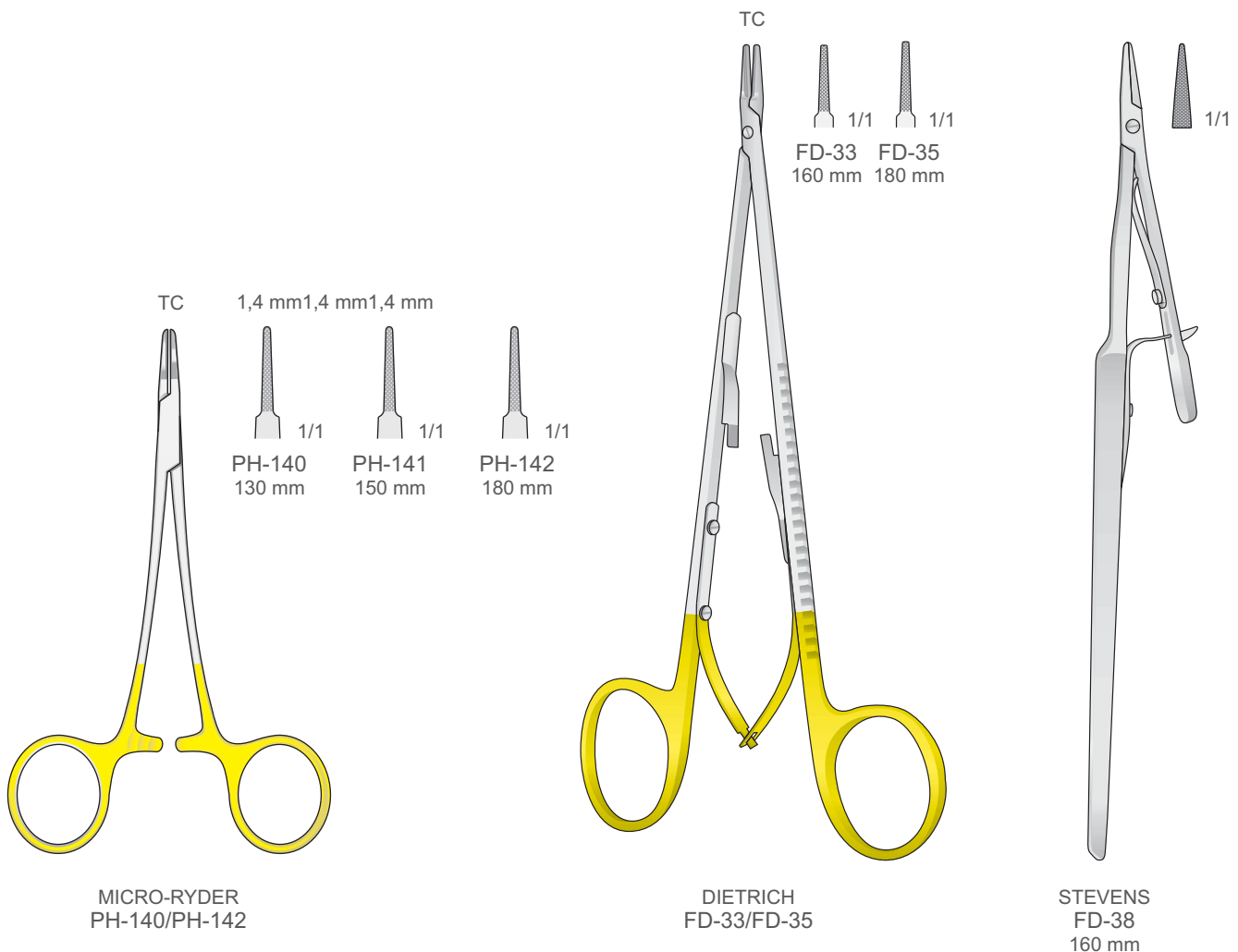



Nadelhalter
Needle Holders
Port'aghi
Portaaguas
Porte aiguilles

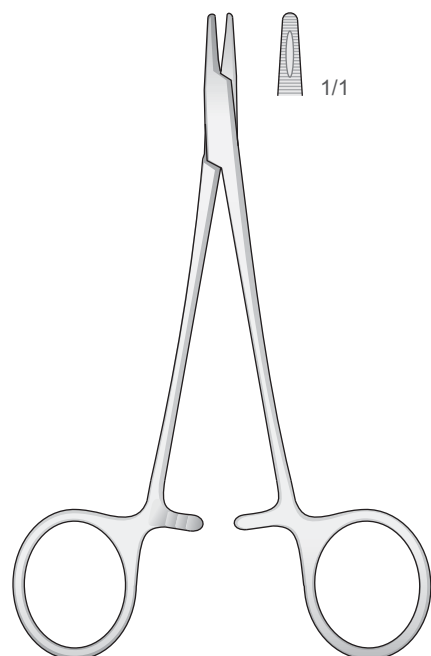

DERF
PH-39
125 mm

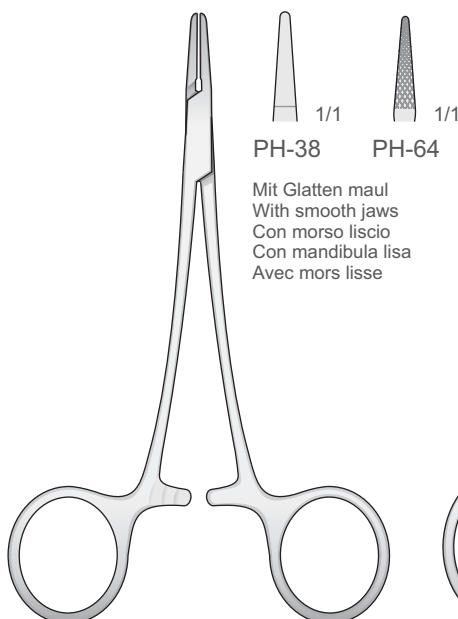

PH-38 PH-64
Mit Glatten maul
With smooth jaws
Con morso liscio
Con mandibula lisa
Avec mors lisse

PH-38/PH-64
120 mm

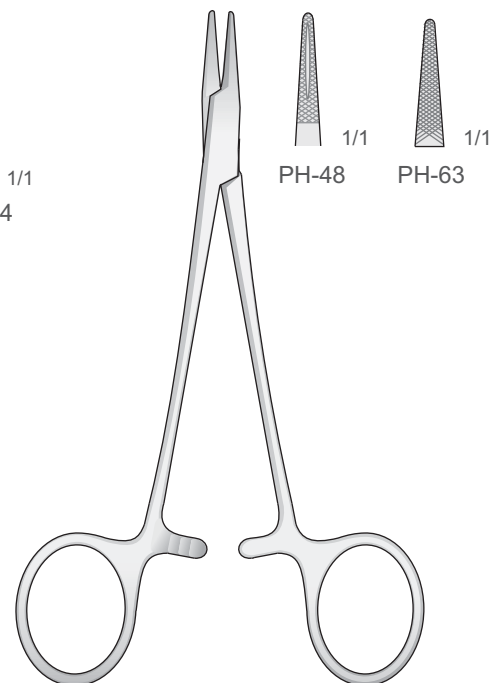

HALSEY
PH-48/PH-63
130 mm

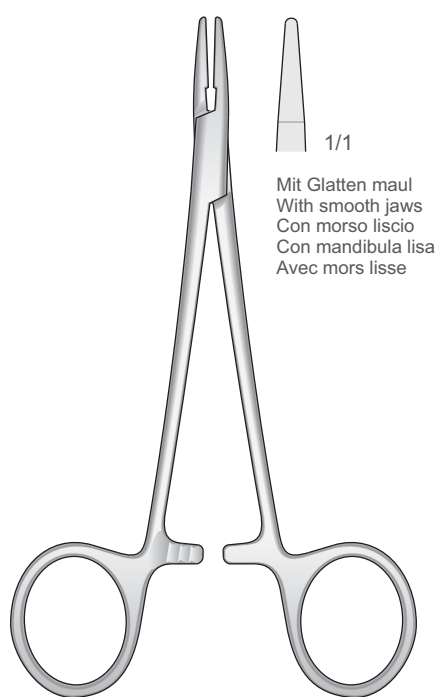

HALSEY
PH-37
130 mm

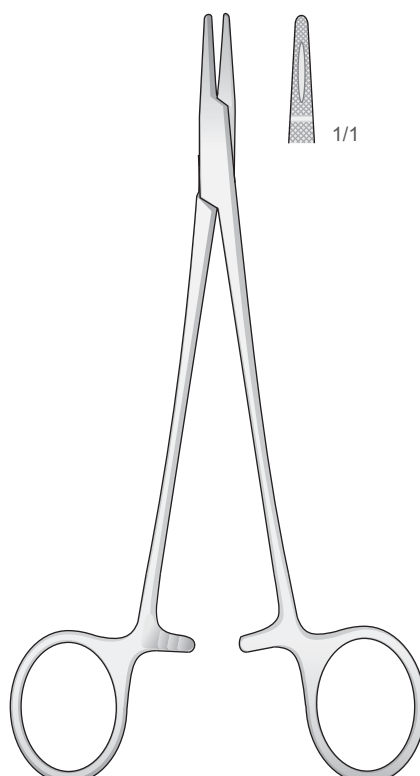

CRILE-WOOD
PH-61
150 mm

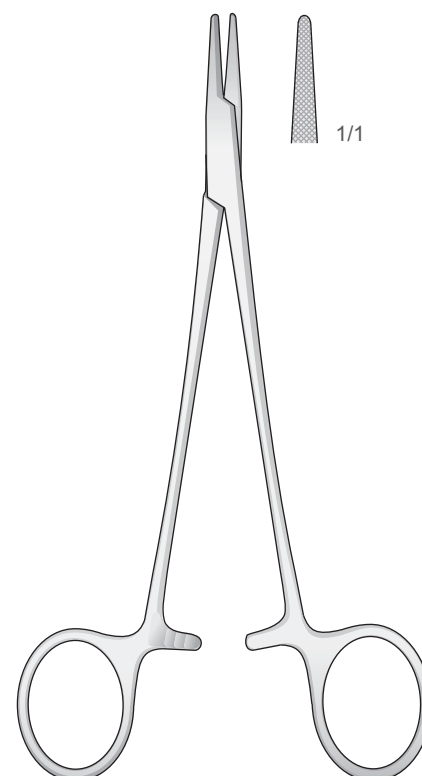

CRILE-MURRAY
PH-62
150 mm

Nadelhalter mit Schere - Needle holders with scissors
Port'aghi con forbici - Portaagujas con tijeras
Porte aiguilles avec ciseaux

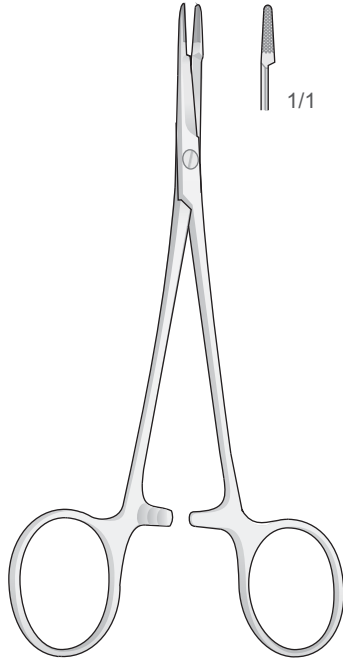

MINI-OLSEN-HEGAR
BM-61
120 mm

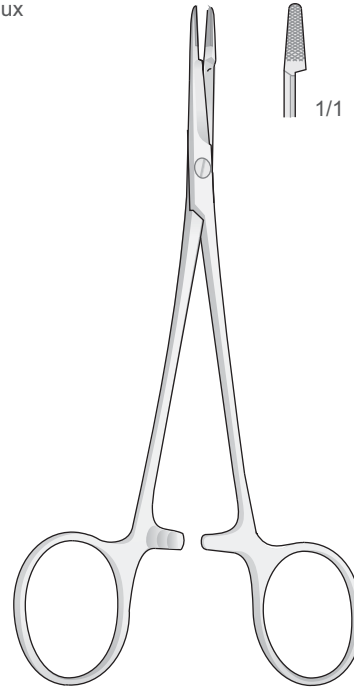

OLSEN-HEGAR
BM-62
140 mm

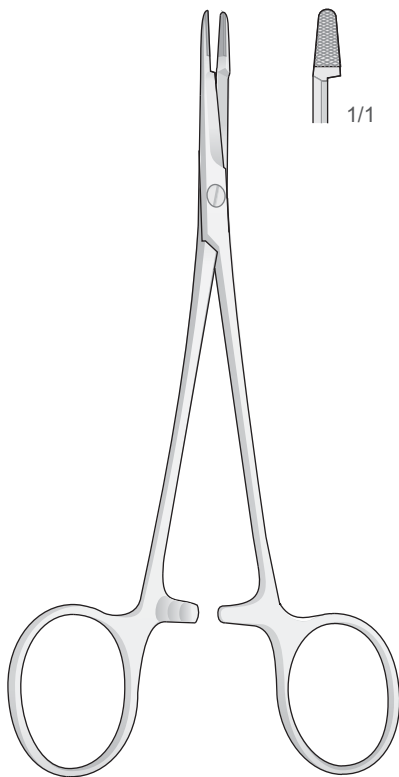

OLSEN-HEGAR
BM-63
170 mm

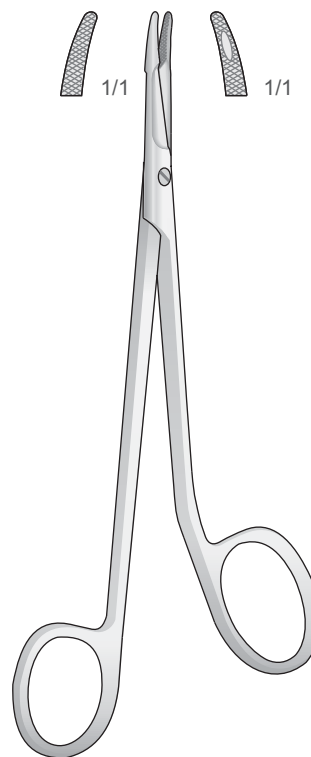

MINI-GILLIES
PO-59
145 mm



Nadelhalter
Needle Holders
Port'aghi
Portaagujas
Porte aiguilles

06

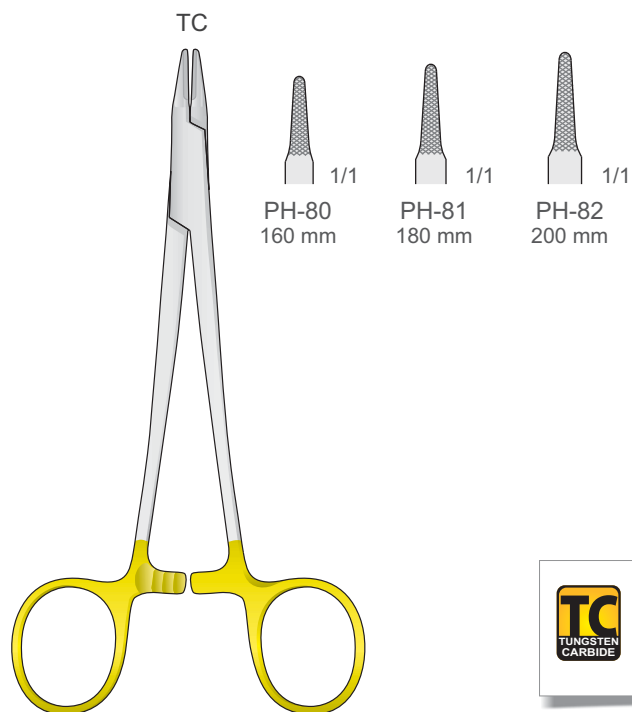

RYDER
PH-80/PH-82

TC
TUNGSTEN
CARBIDE

Tungsten-Carbide Inserts
Mit Hartmetalleinsätzen
Plaquettes en carbure de tungstène
Plaquetas de carburo de tungsteno
Inserti in carburo di tungsteno

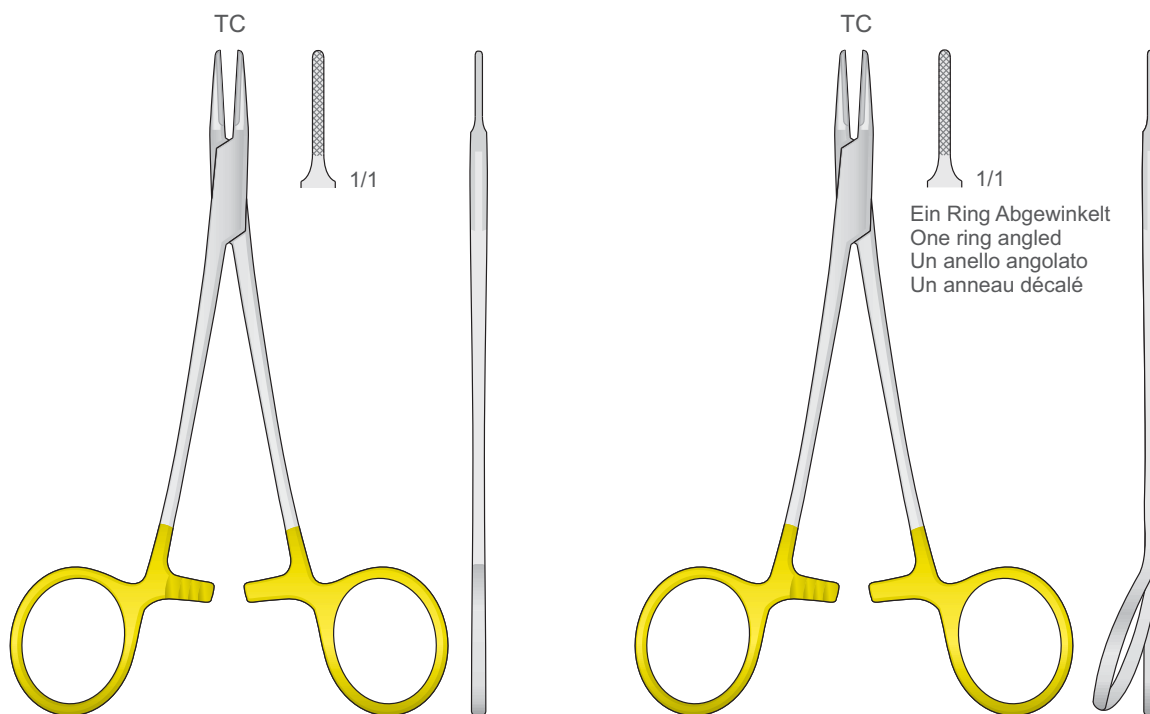

RYDER
PH-83
140 mm

PH-84
140 mm

Ein Ring Abgewinkelt
One ring angled
Un anello angolato
Un anneau décalé



Tungsten-Carbide Inserts
Mit Hartmetalleinsätzen
Plaquettes en carbure de tungstène
Plaquetas de carburo de tungsteno
Inserti in carburo di tungsteno

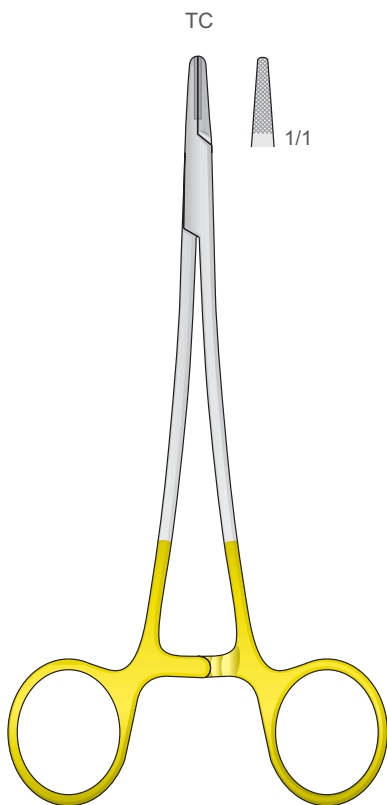

PH-79
145 mm

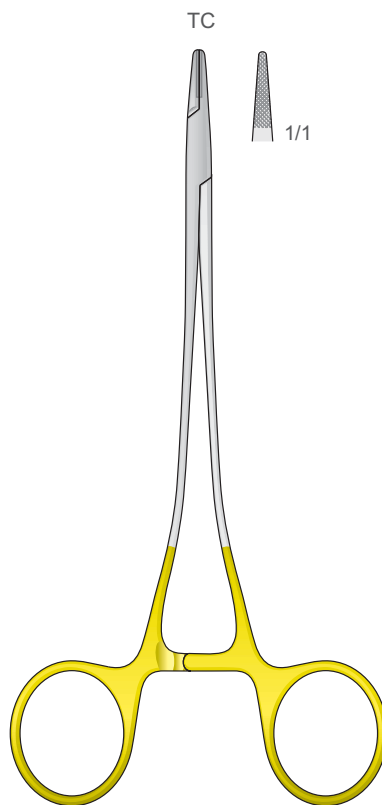

FINE SWEDISH PATTERN
PH-85
150 mm

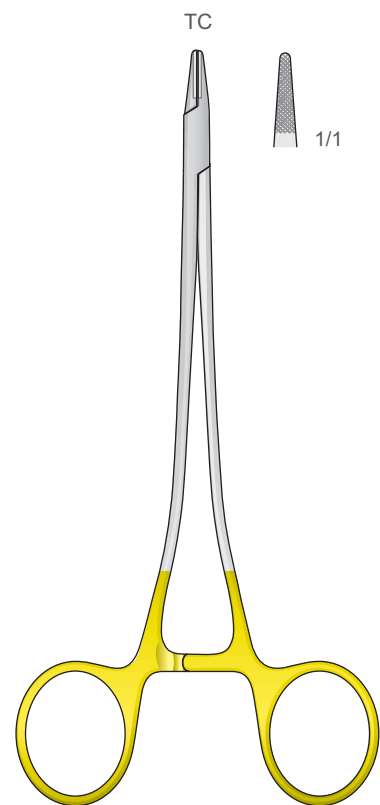

SWEDISH MOD.
PH-106
150 mm



Nadelhalter
Needle Holders
Port'aghi
Portaagujas
Porte aiguilles

06



Tungsten-Carbide Inserts
Mit Hartmetalleinsätzen
Plaquettes en carbure de tungstène
Plaquetas de carburo de tungsteno
Inserti in carburo di tungsteno

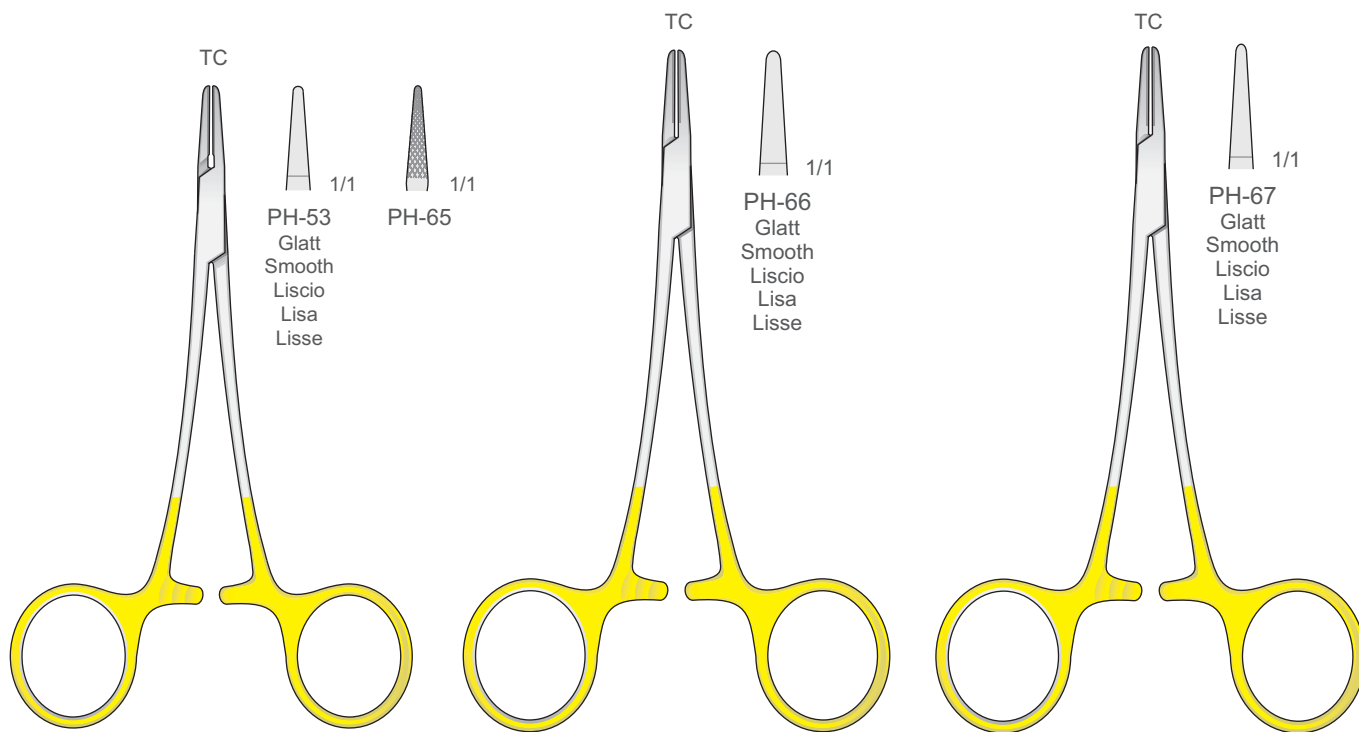

PH-53/PH-65
120 mm

WEBSTER
PH-66
130 mm

HALSEY
PH-67
130 mm

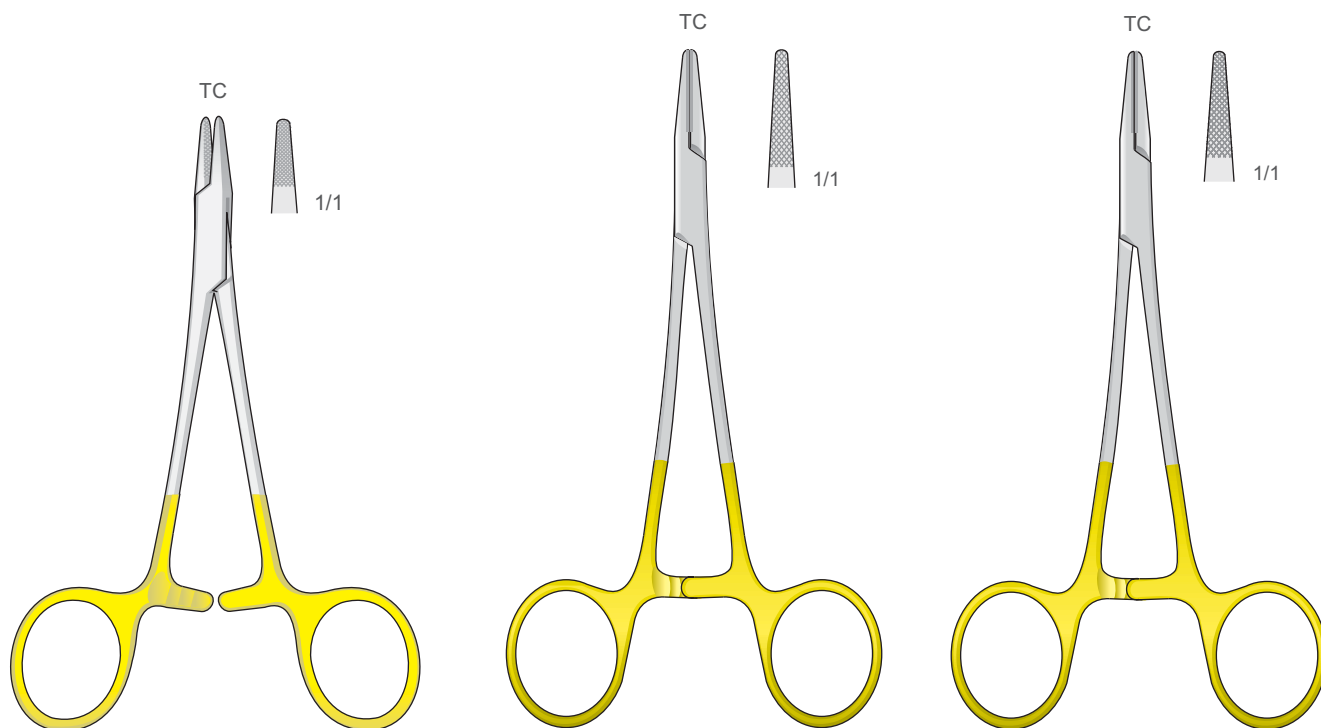

DERF
PH-69
115 mm

CONVERSE
PH-68
130 mm

HALSEY
PH-73
130 mm



Tungsten-Carbide Inserts
Mit Hartmetalleinsätzen
Plaquettes en carbure de tungstène
Plaquetas de carburo de tungsteno
Inserti in carburo di tungsteno

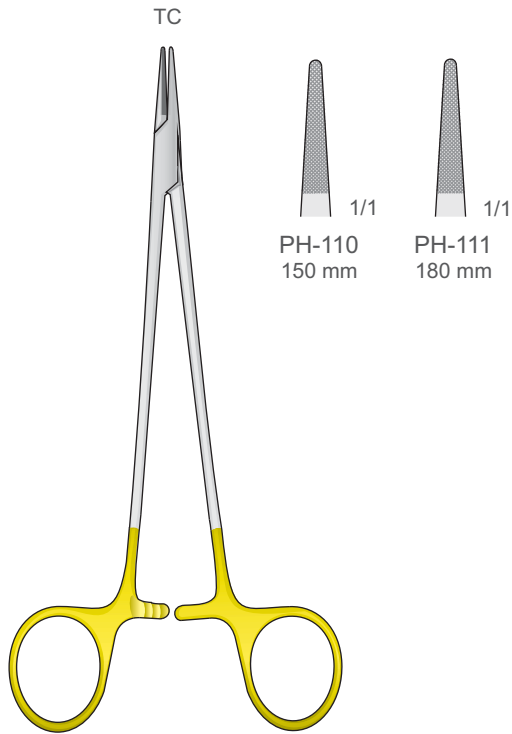

DE BAKEY
PH-110/PH-111

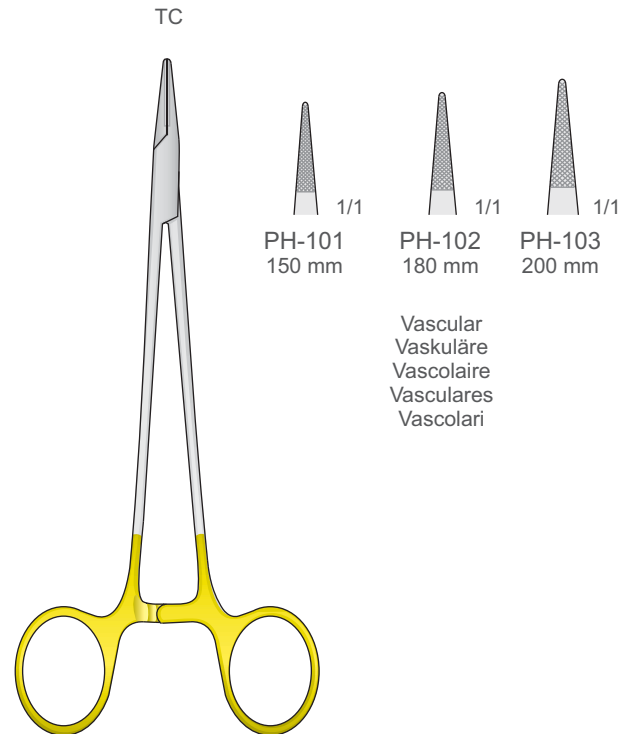

MICRO-VASCULAR
PH-101/PH-102/PH-103

Vascular
Vaskuläre
Vasculaire
Vasculares
Vascolari

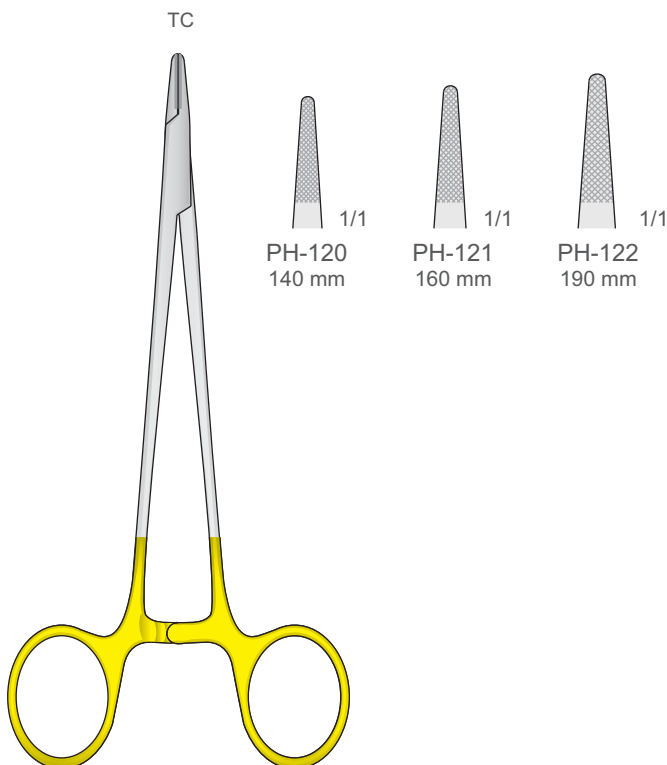

MAYO-HEGAR
PH-120/PH-121/PH-122

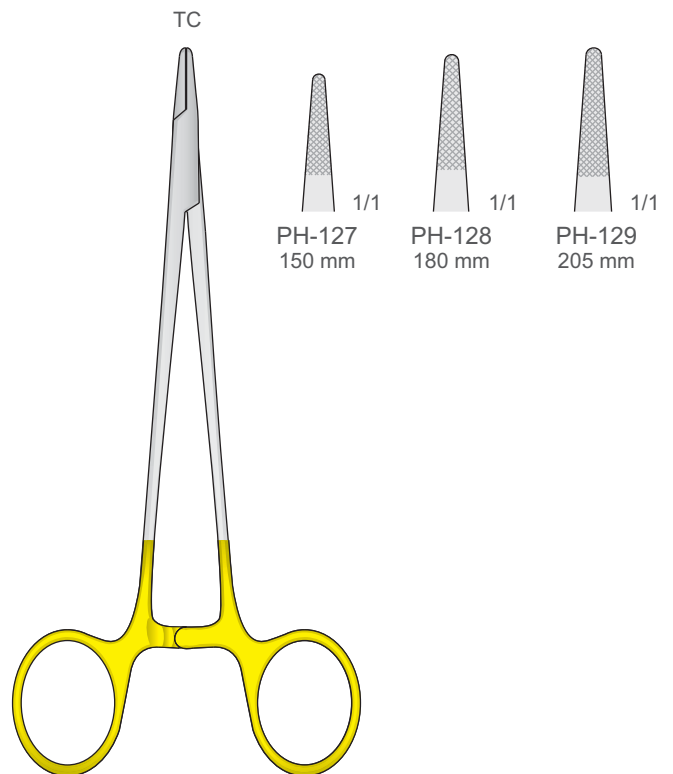

MAYO-HEGAR-FINO
PH-127/PH-128/PH-129



Nadelhalter
Needle Holders
Port'aghi
Portaagujas
Porte aiguilles

TC
TUNGSTEN
CARBIDE

Tungsten-Carbide Inserts
Mit Hartmetalleinsätzen
Plaquettes en carbure de tungstène
Plaquetas de carburo de tungsteno
Inserti in carburo di tungsteno

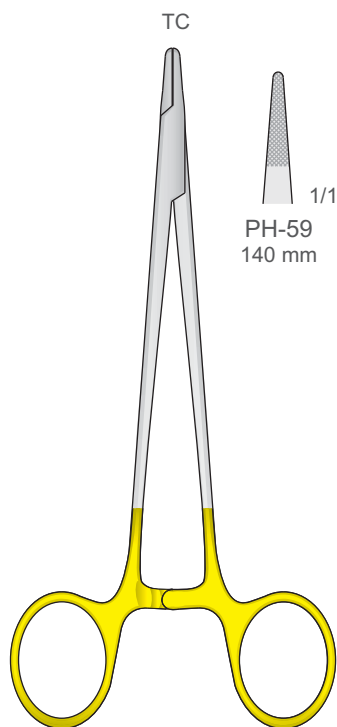

HEGAR
PH-59/PH-76

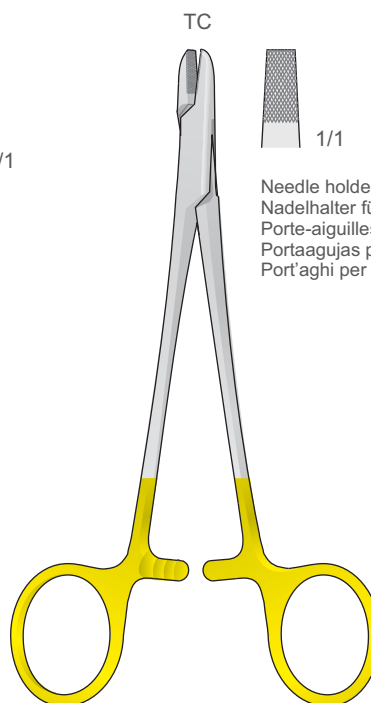
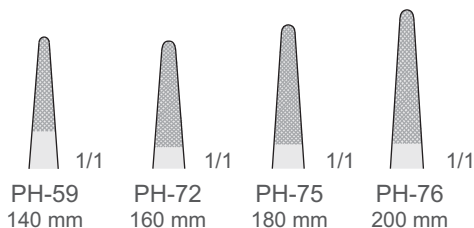

PH-58
150 mm

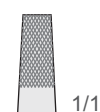

Needle holders for wire
Nadelhalter für drähte
Porte-aiguilles pour fil métallique
Portaagujas para hilo metálico
Port'aghi per fili metallici

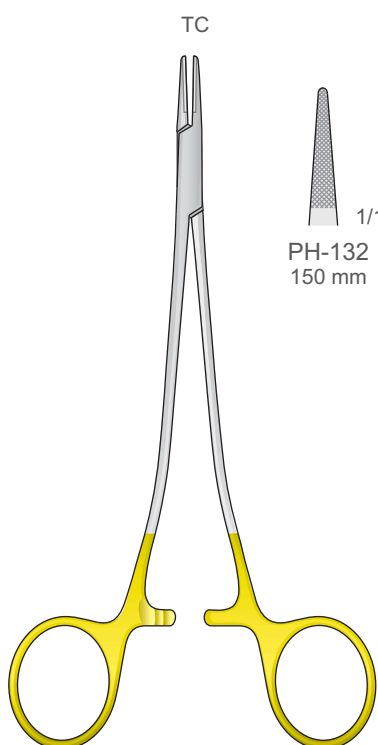

SAROT
PH-132/PH-134

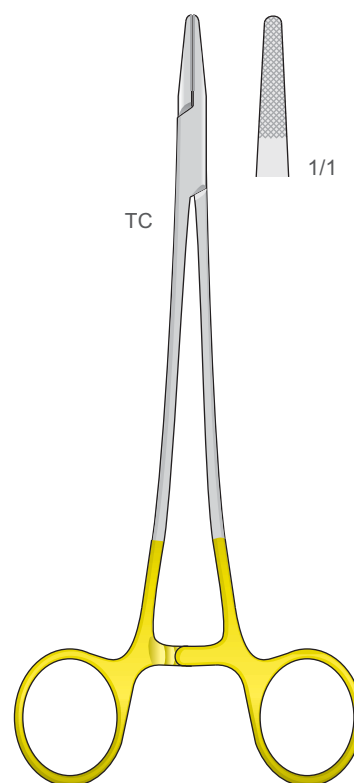
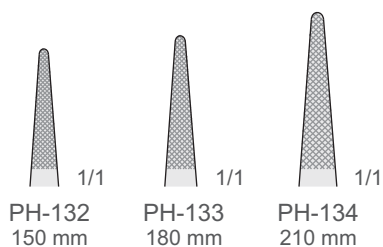

CRILE-WOOD
PH-77
180 mm

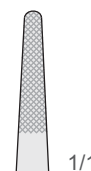



Tungsten-Carbide Inserts
Mit Hartmetalleinsätzen
Plaquettes en carbure de tungstène
Plaquetas de carburo de tungsteno
Inserti in carburo di tungsteno

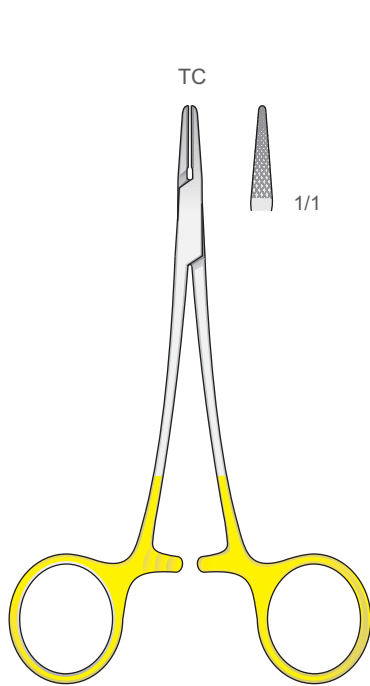

PH-99
120 mm

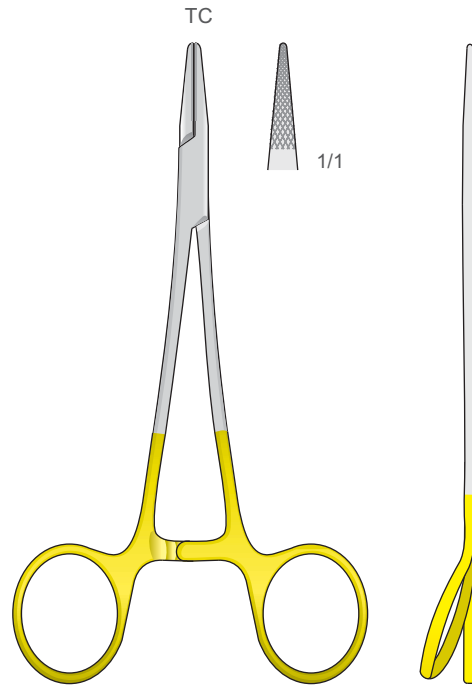

CRILE-WOOD
PH-100
150 mm

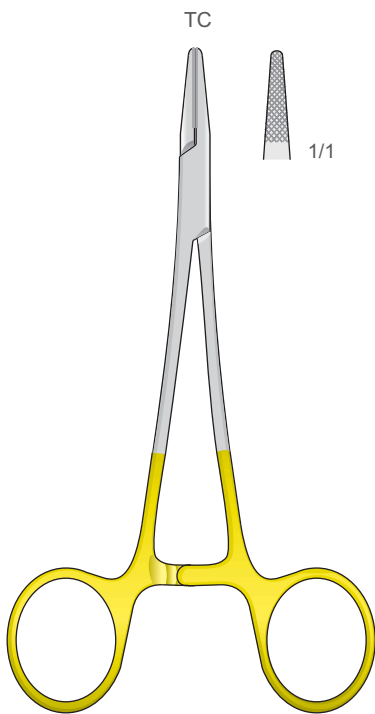

BABY-CRILE-WOOD
PH-54
150 mm

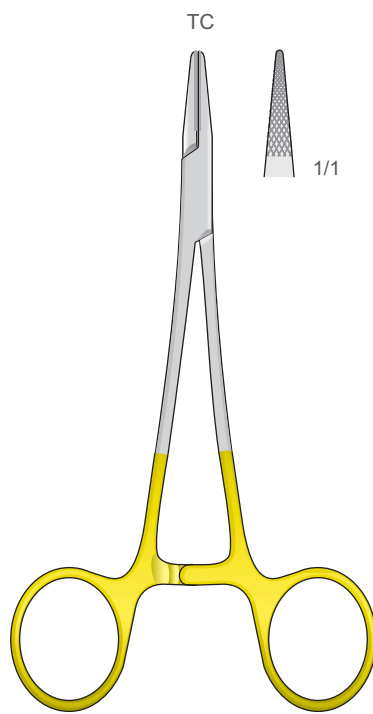

CRILE-WOOD
PH-71
150 mm



CRILE-WOOD
PH-90
150 mm



Nadelhalter
Needle Holders
Port'aghi
Portaagujas
Porte aiguilles



Tungsten-Carbide Inserts
Mit Hartmetalleinsätzen
Plaquettes en carbure de tungstène
Plaquetas de carburo de tungsteno
Inserti in carburo di tungsteno

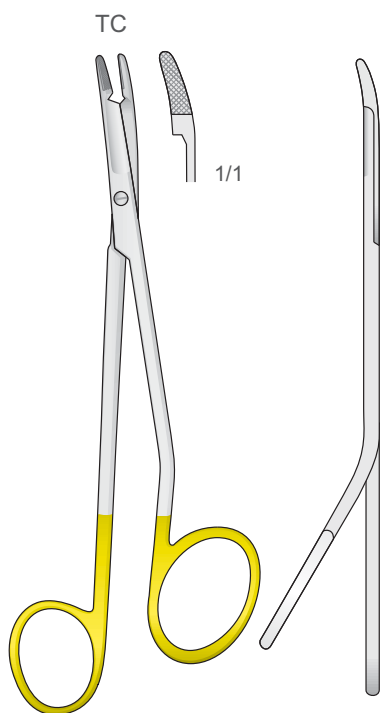

MINI-GILLIES
PO-99
145 mm

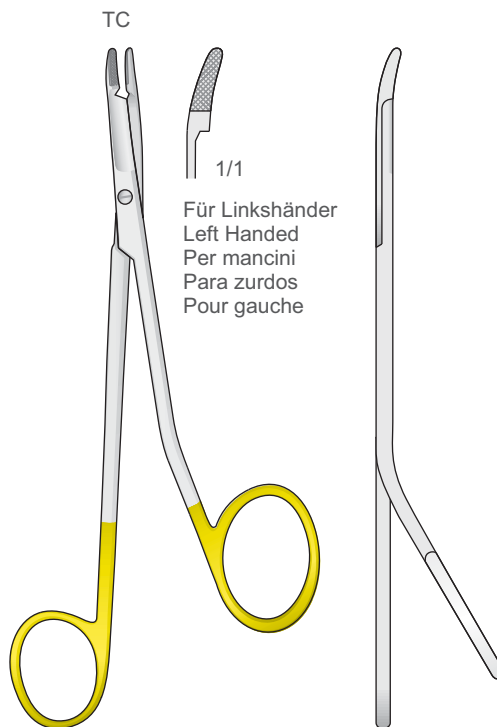

MINI-GILLIES
PO-99L
145 mm

Für Linkshänder
Left Handed
Per mancini
Para zurdos
Pour gauche

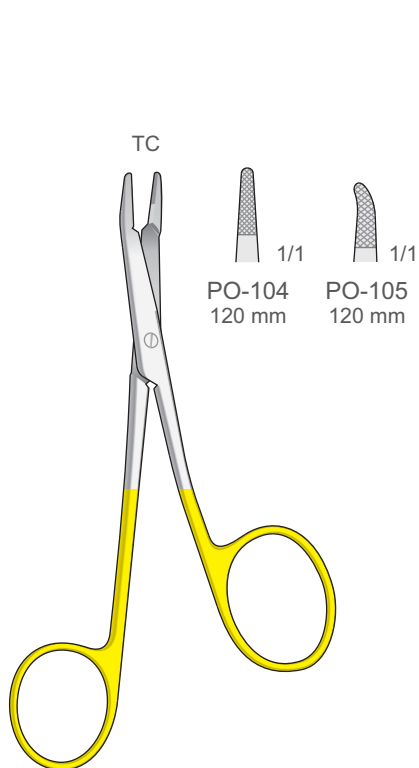

FOSTER-GILLIES
PO-104/PO-105
120 mm

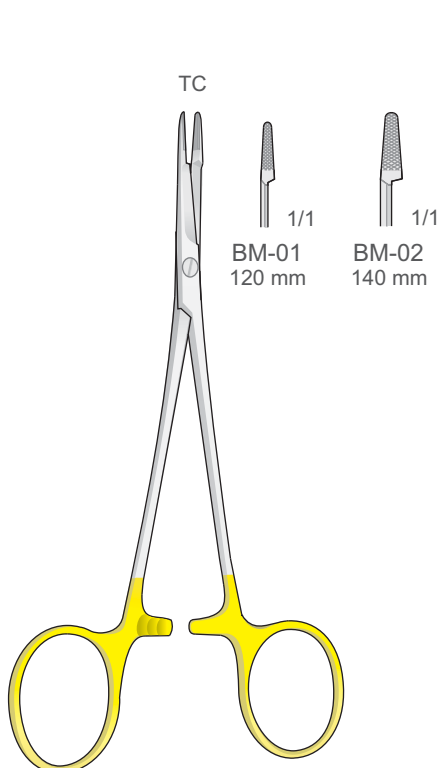

OLSEN-HEGAR
BM-01/BM-02

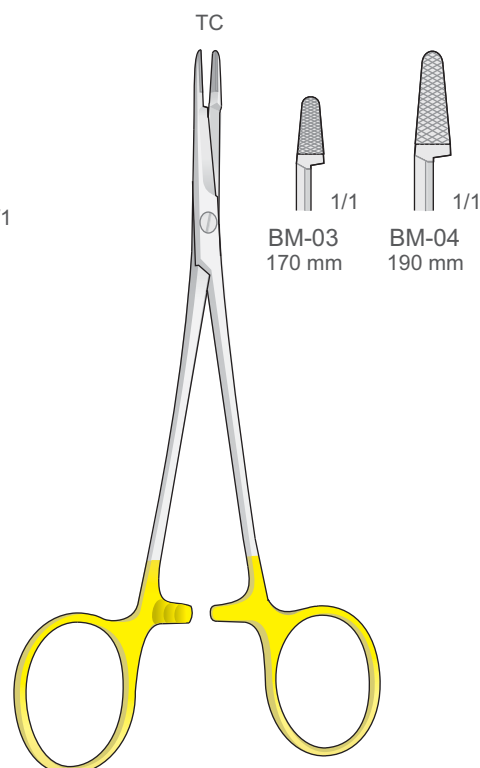

OLSEN-HEGAR
BM-03/BM-04

05

Nadelhalter
Needle Holders
Port'aghi
Portaagujas
Porte aiguilles

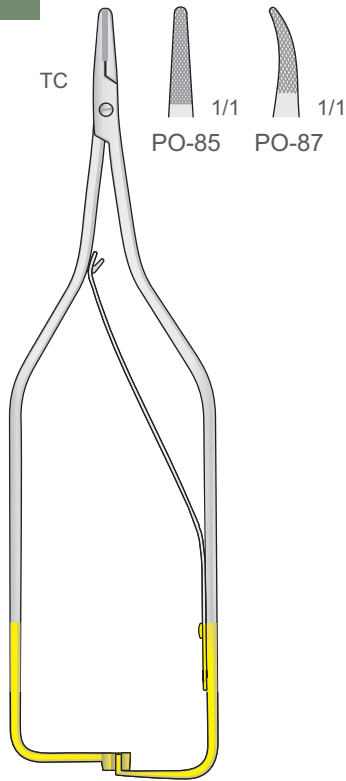

ARRUGA
PO-85/PO-87
160 mm

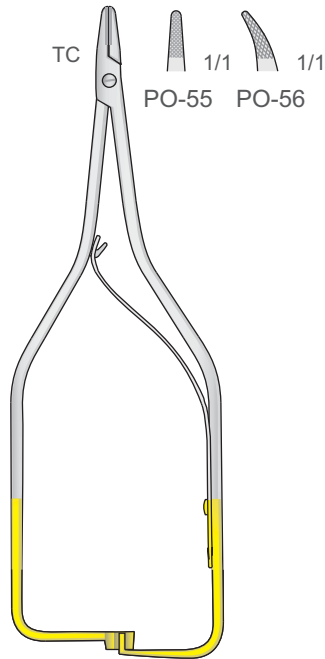

BOYNTON
PO-55/PO-56
120 mm

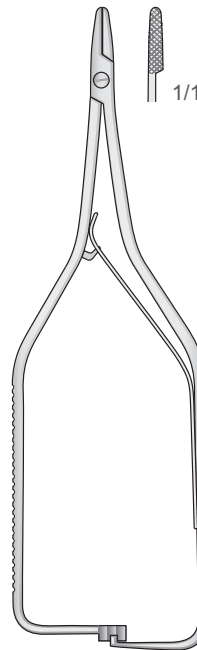

BOYNTON
PO-88
120 mm

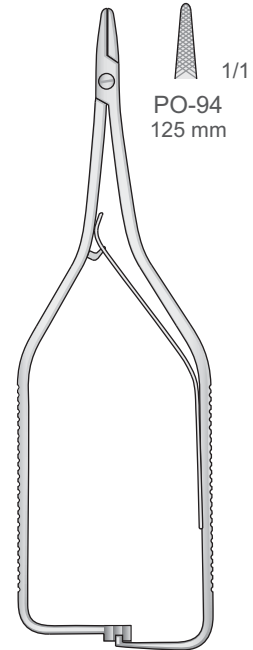

BOYNTON
PO-94
125 mm

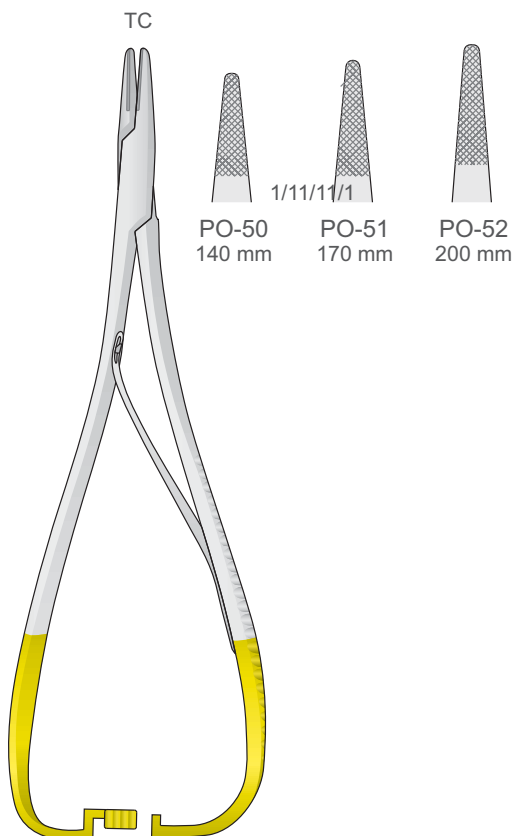

MATHIEU
PO-50/PO-52

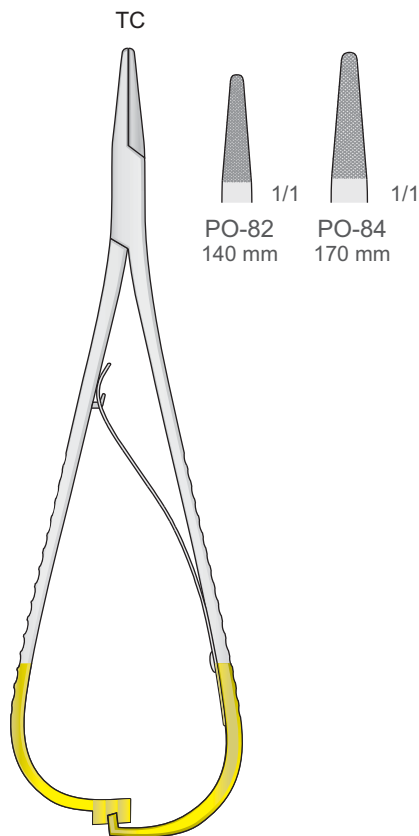

MATHIEU
PO-82/PO-84

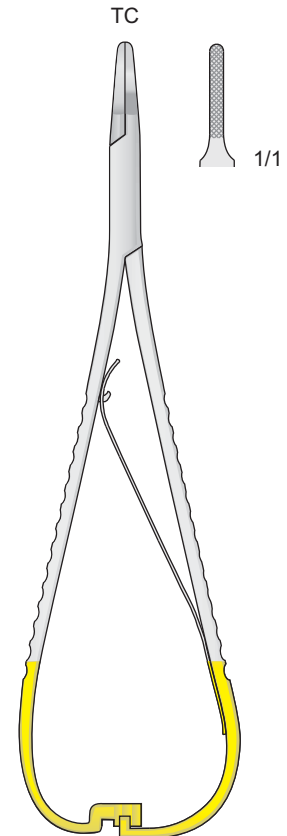

LICHTENBERG
PO-86



Nadelhalter
Needle Holders
Port'aghi
Portaagujas
Porte aiguilles

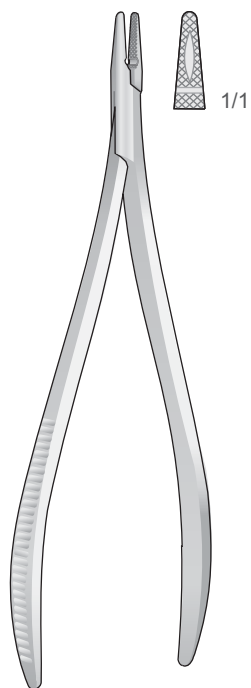

CRILE
PO-37
150 mm

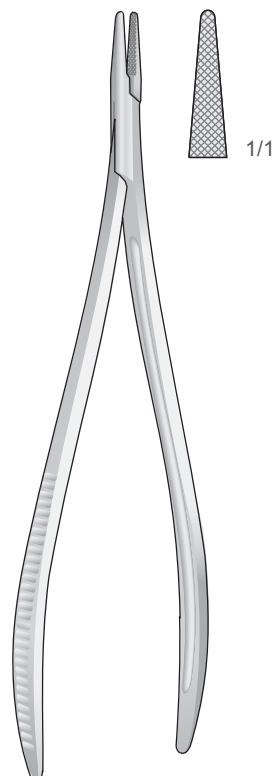

TÖNNIS
PO-38
190 mm

Schlankesmodell - Delicate pattern - Modello fine
Modelo delegado - Modèle fin

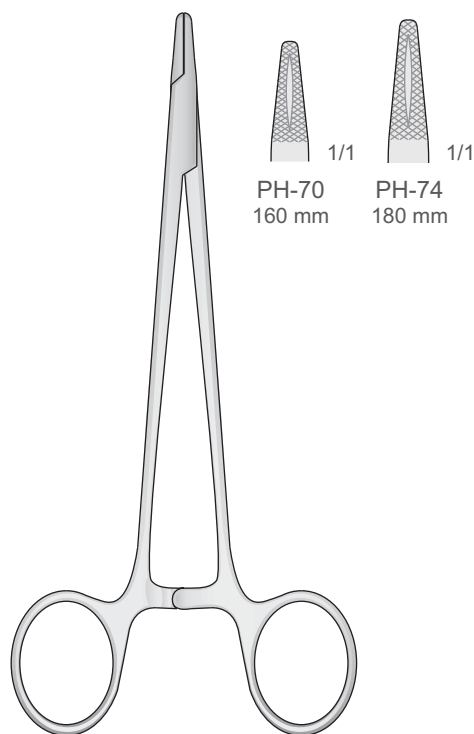

HEGAR
PH-70/PH-74

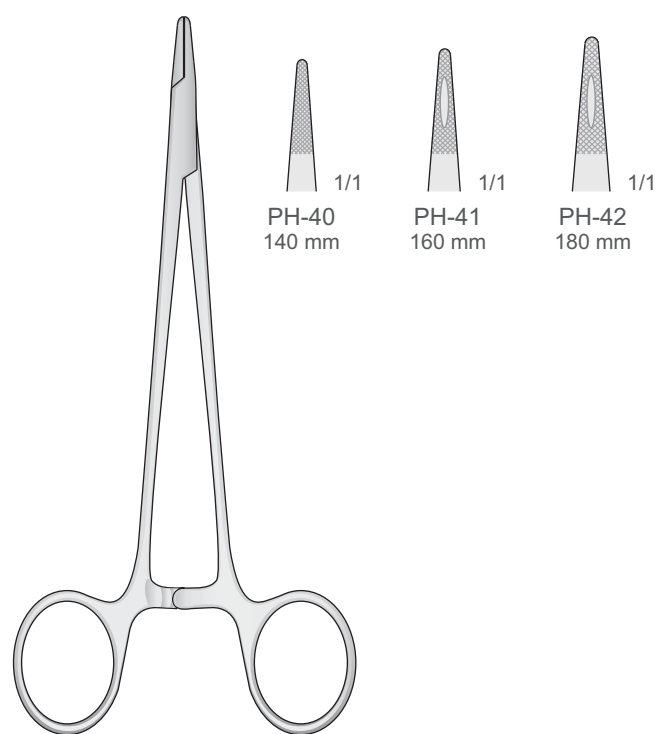

MAYO-HEGAR
PH-40/PH-42

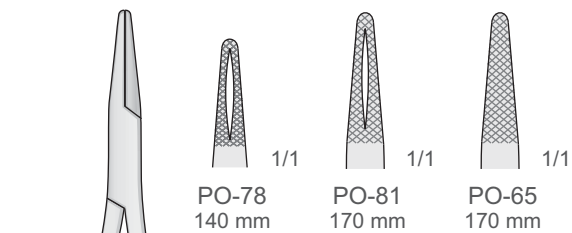

MATHIEU
PO-65/PO-81

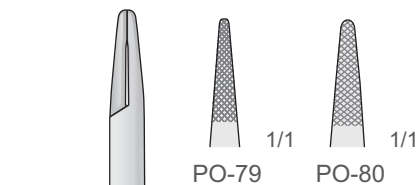

MATHIEU
PO-79/PO-80
140 mm

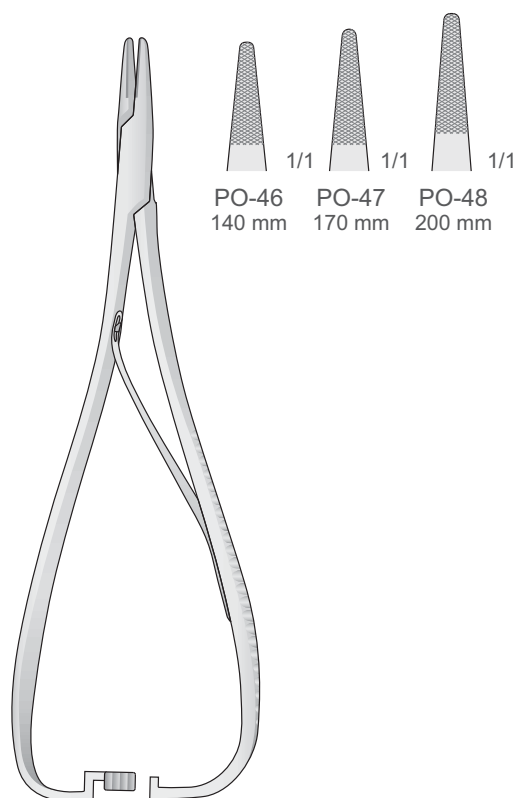

MATHIEU
PO-46/PO-48

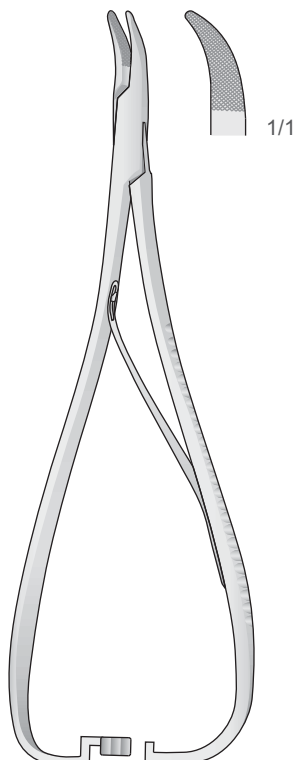

PO-40
140 mm



Nadelhalter
Needle Holders
Port'aghi
Portaagujas
Porte aiguilles

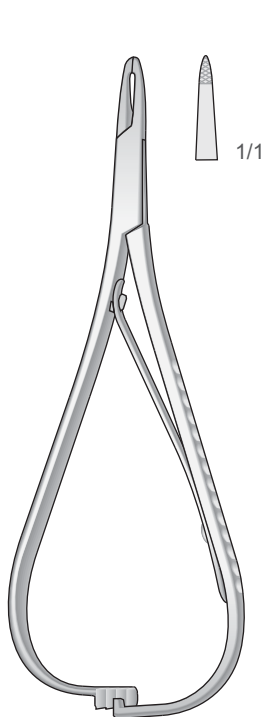

MATHIEU
PO-45
125 mm

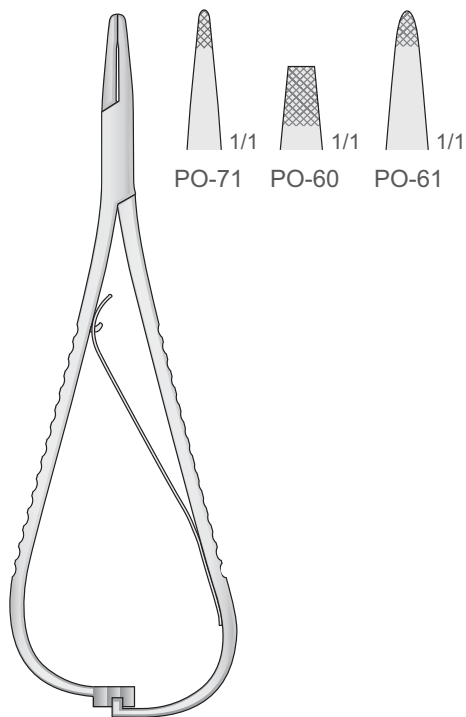

MATHIEU
PO-60/PO-71
140 mm

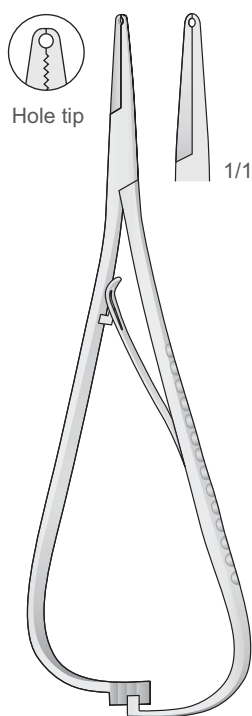

SMAHA
PO-68
140 mm

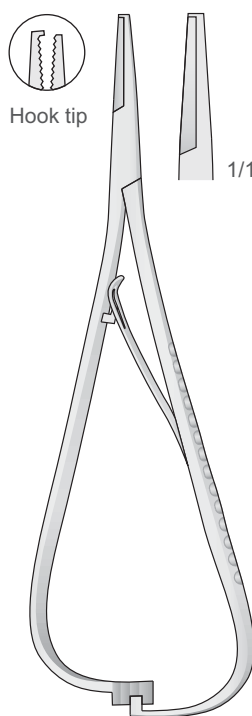

SMAHA
PO-69
140 mm

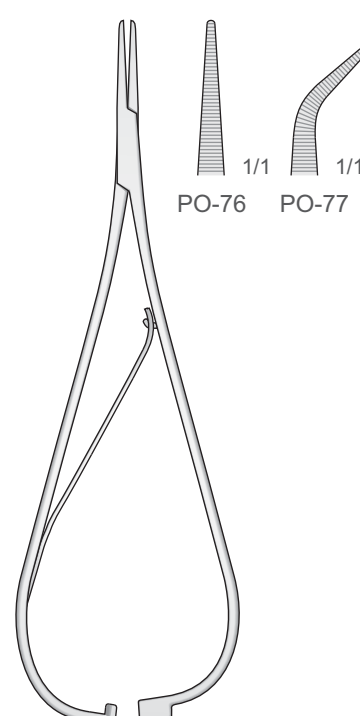

SMAHA
PO-76/PO-77
140 mm

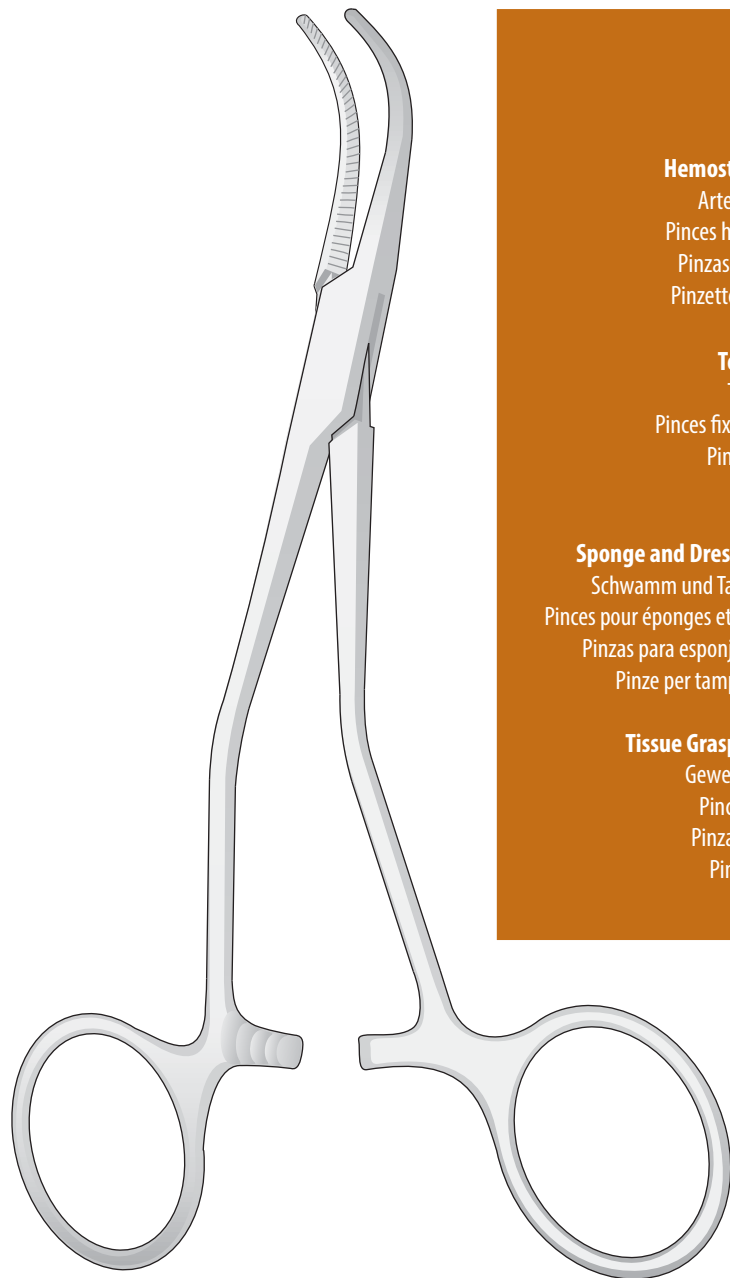

07

Hemostatic Forceps
Arterienklemmen
Pinces hémostatiques
Pinzas hemostáticas
Pinzette emostatiche

Towel Clamps
Tuchklemmen
Pinces fixe-compresses
Pinzas de campo
Fissateli

Sponge and Dressing Forceps
Schwamm und Tamponzangen
Pinces pour éponges et à pansement
Pinzas para esponja y tampones
Pinze per tamponi e spunge

Tissue Grasping Forceps
Gewebebefasszangen
Pinces pour tissus
Pinzas para tejidos
Pinze per tessuti



Tuchklemmen
Towel Clamps
Fissateli
Pinzas de campo
Pincas fixe-compresses

07

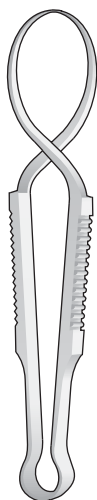

SCHAEDEL
BF-38
85 mm

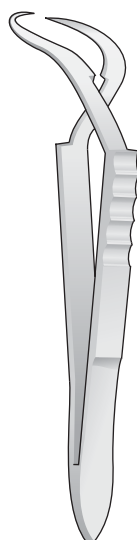

JONES
BF-48
90 mm

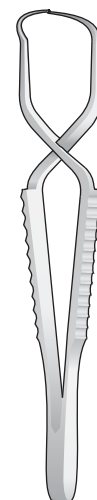

FAURE
BF-40
85 mm

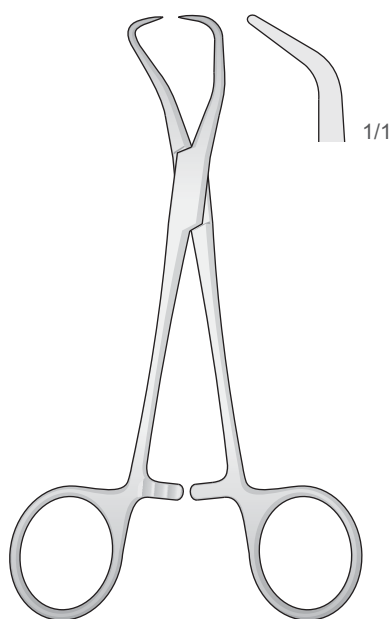

BACKHAUS
BF-42/BF-46

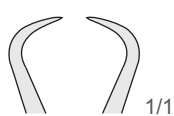

BF-42
90 mm

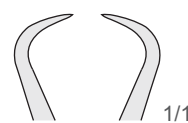

BF-41
100 mm

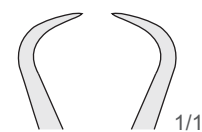

BF-44
110 mm

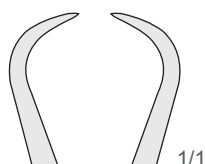

BF-46
130 mm

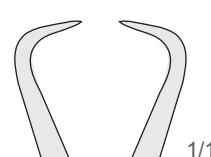

BF-43
135 mm

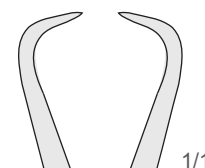

BF-45
140 mm

Für Papiertücher
For paper cloths
Per teli di carta
Para paños
Pour papier

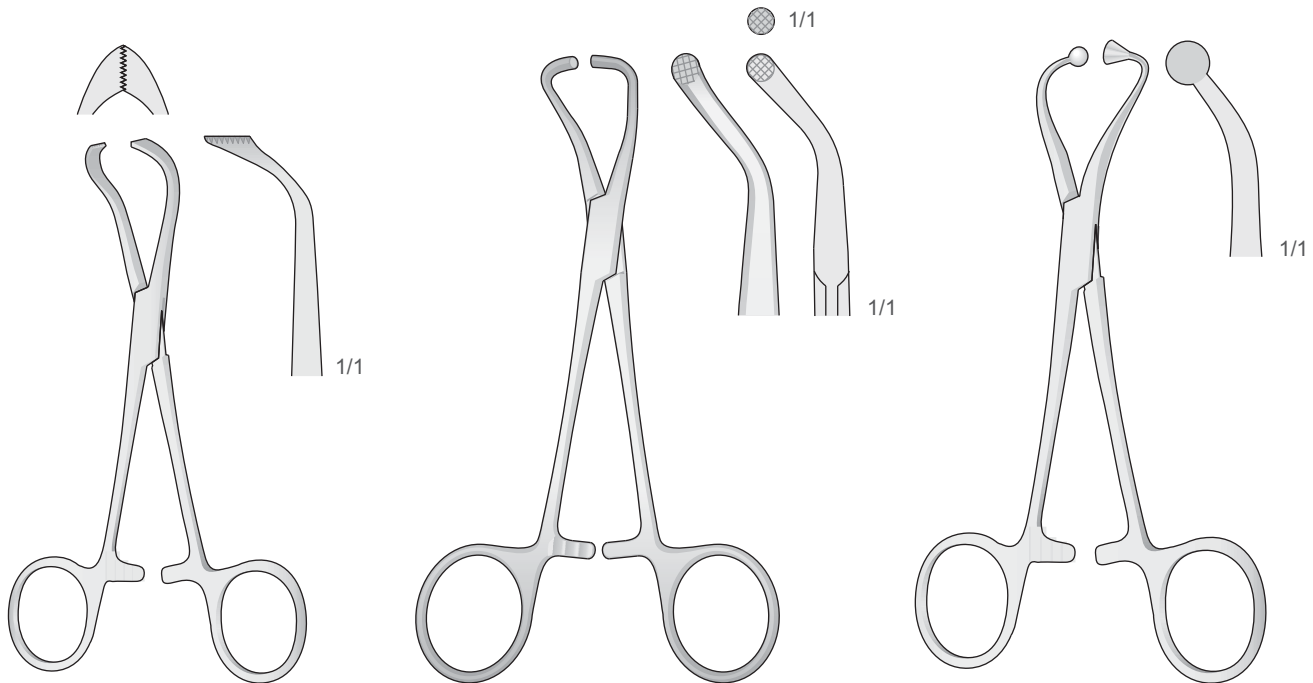

LORNA
BF-50
100 mm

BF-52
130 mm

BF-75
140 mm



Schwamm und Tamponzangen
Sponge and Dressing Forceps
Pinze per tamponi e sponge
Pinzas para esponja y tampones
Pincas pour éponges et à pansement

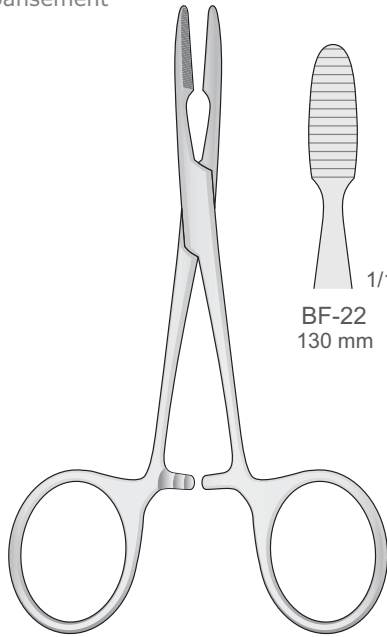

BF-22
130 mm

BF-24
140 mm

PEAN-MURPHY
BF-22/BF-24

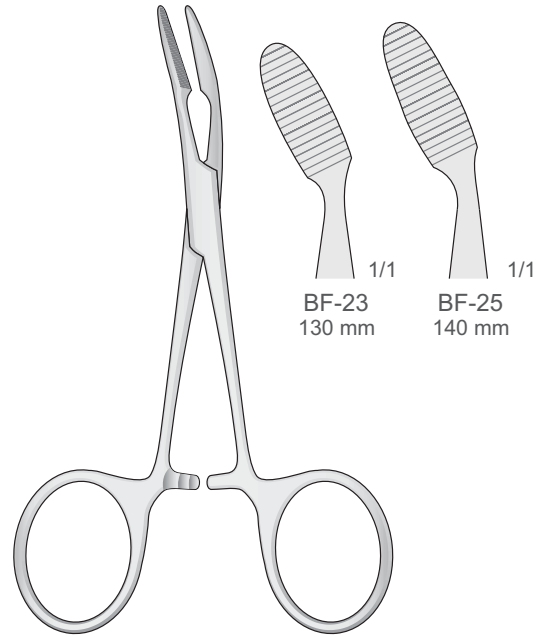

BF-23
130 mm

BF-25
140 mm

PEAN-MURPHY
BF-23/BF-25

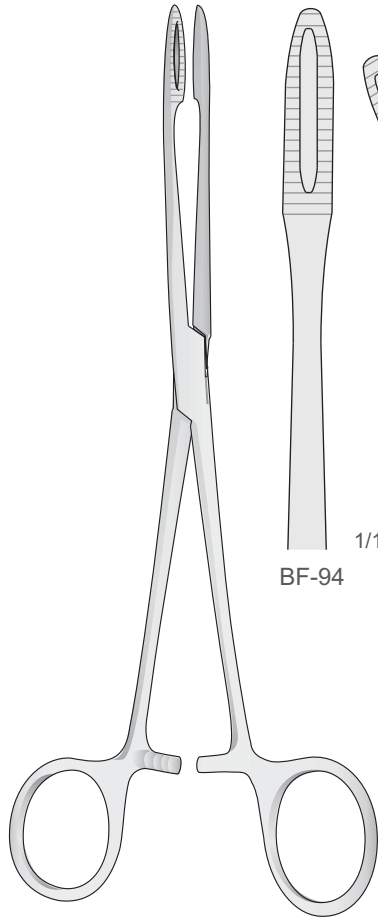

BF-94

BF-95

GROSS
BF-94/BF-95
200 mm

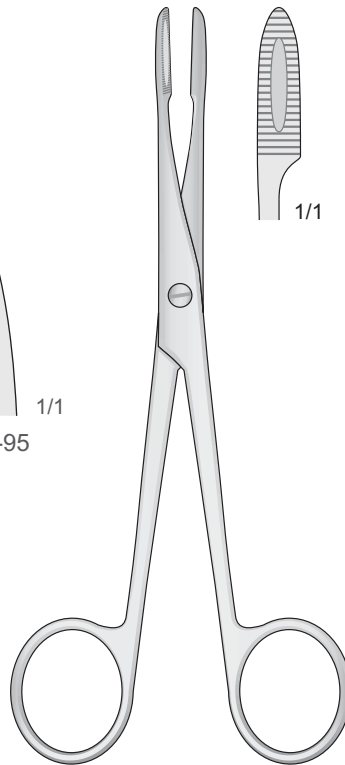

BF-10

BF-12

GROSS
BF-10 130 mm
BF-12 160 mm

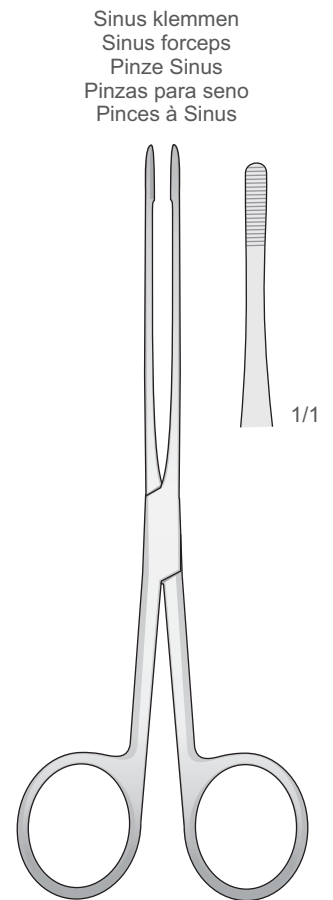

Sinus klemmen
Sinus forceps
Pinze Sinus
Pinzas para seno
Pincas à Sinus

BF-20

LISTER
BF-20
150 mm

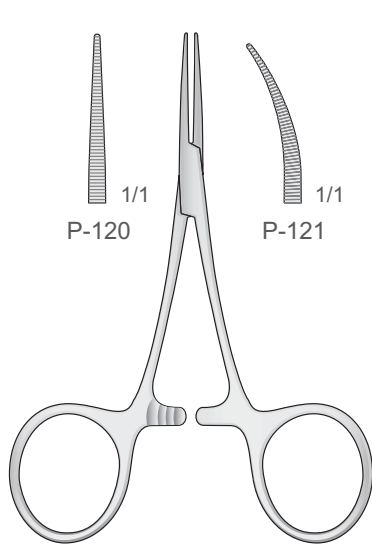

HARTMANN/BABY-MOSQUITO
P-120/P-121
95 mm

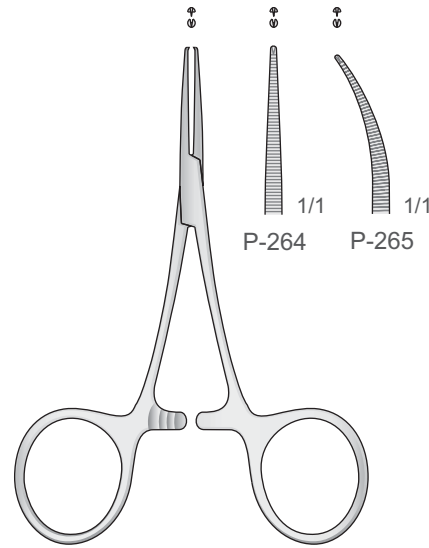

HARTMANN/BABY-MOSQUITO
P-264/P-265
95 mm

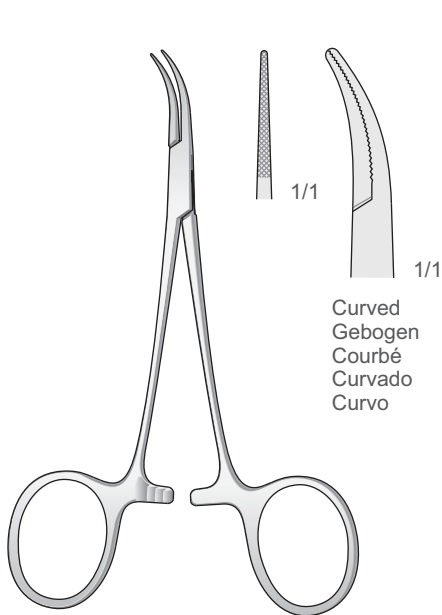

DANDY-MOSQUITO
P-332
120 mm

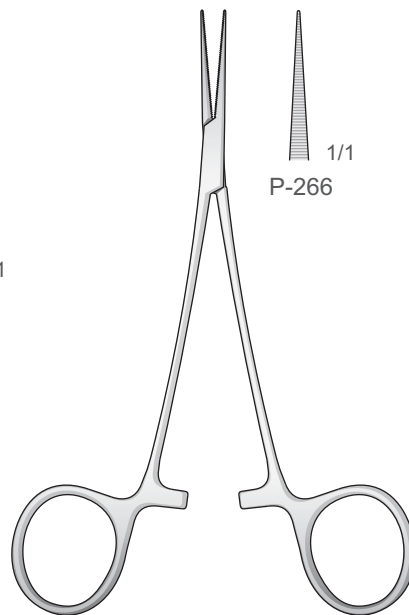

JACOBSON-MICRO
P-266
130 mm

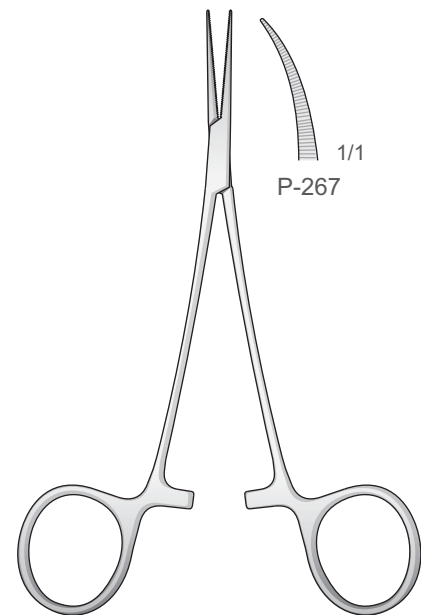

JACOBSON-MICRO
P-267
130 mm



Arterienklemmen
Hemostatic Forceps
Pinze emostatiche
Pinzas hemostáticas
Pinces hémostatiques

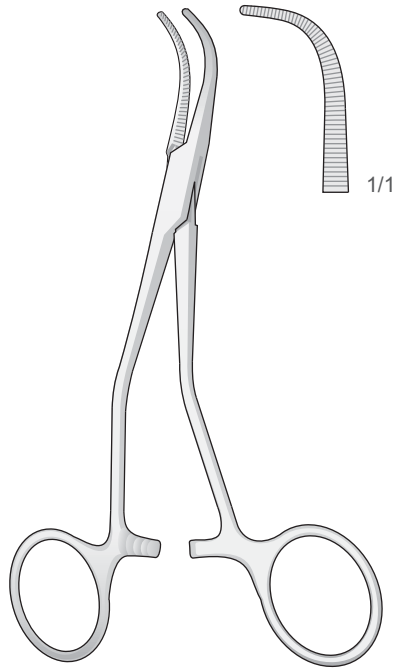

P-15
130 mm

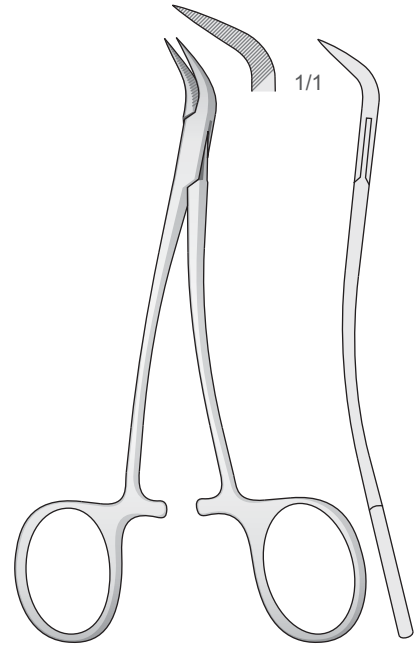

PEET
DR-40
120 mm

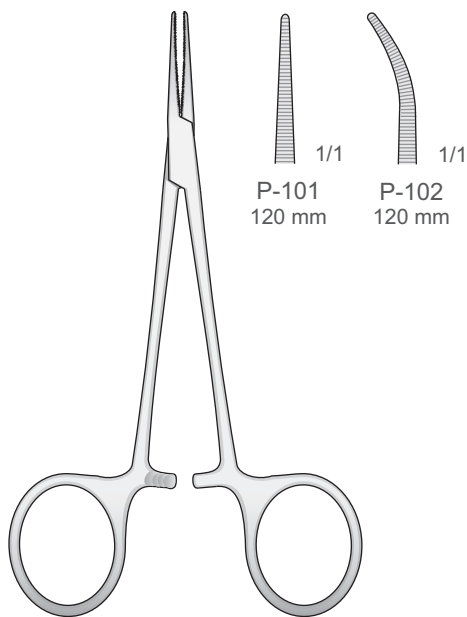

P-101
120 mm

P-102
120 mm

MICRO-HALSTED
P-101/P-102

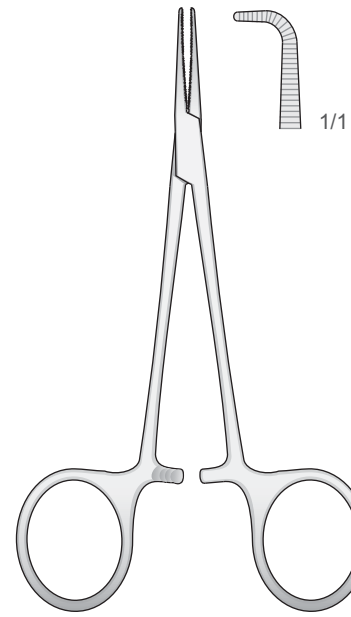

MICRO-HALSTED
P-135
115 mm

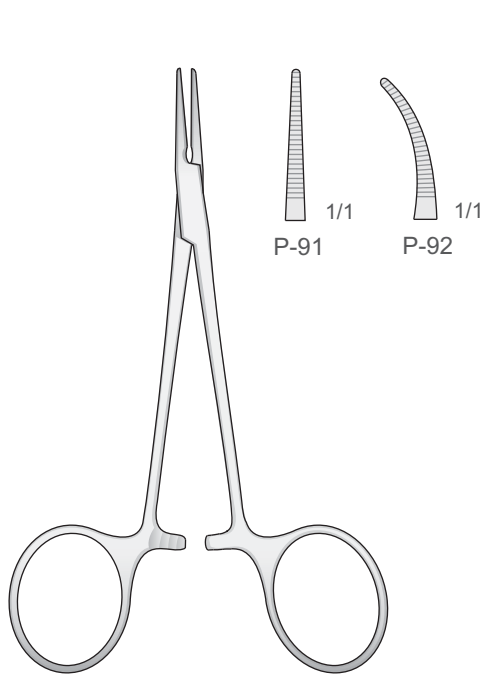

HALSTED
P-91/P-92
125 mm

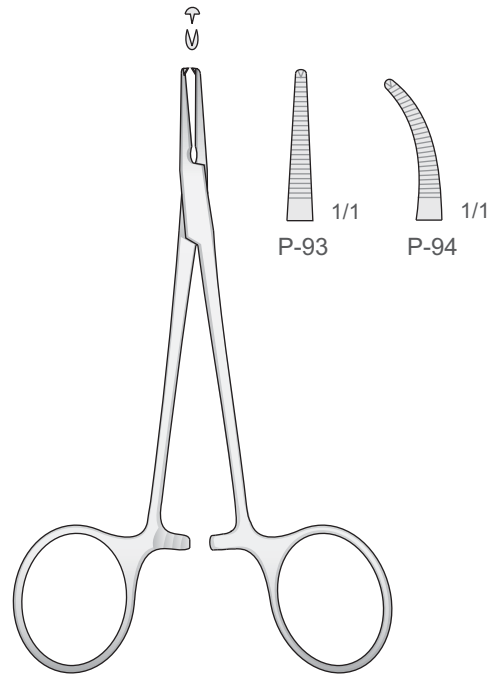

HALSTED
P-93/P-94
125 mm

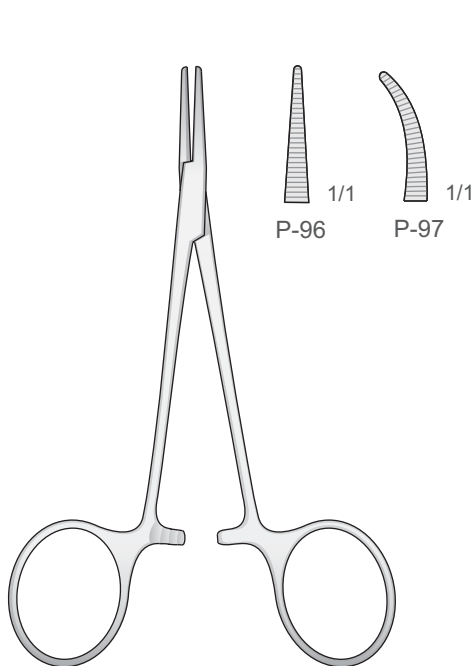

HALSTED-MOSQUITO
P-96/P-97
120 mm

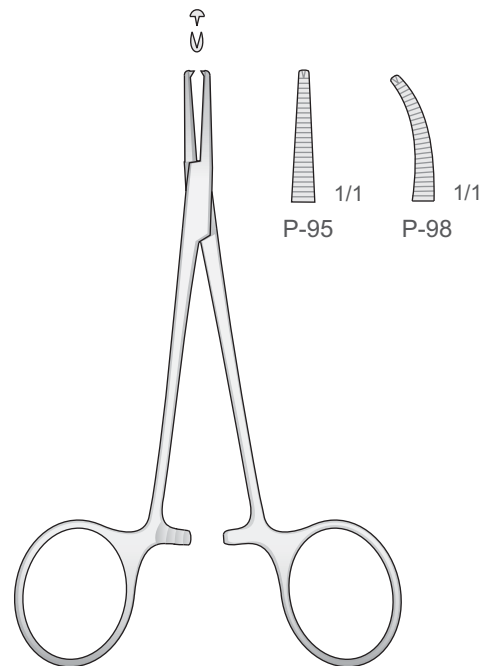

HALSTED-MOSQUITO
P-95/P-98
120 mm



Arterienklemmen
Hemostatic Forceps
Pinze emostatiche
Pinzas hemostáticas
Pincas hémostatiques

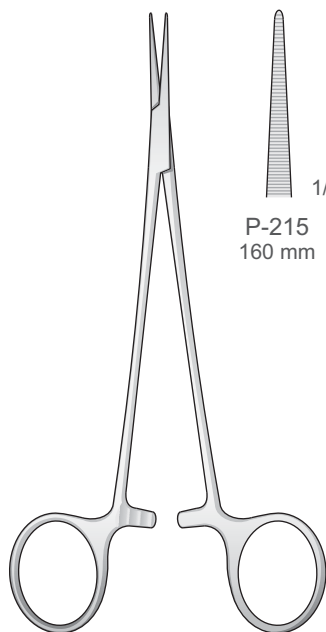

P-215/P-217
160 mm

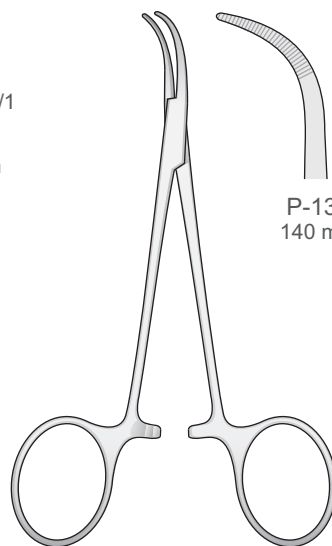
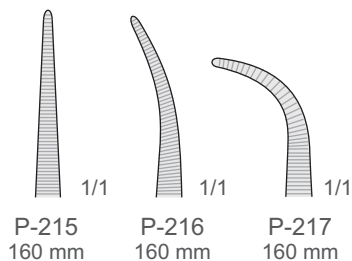

BABY-MIXTER
P-136/P-137

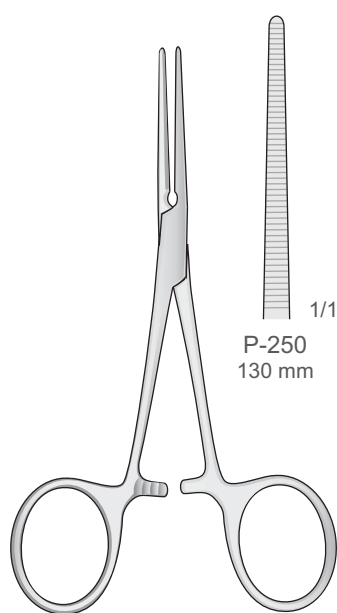
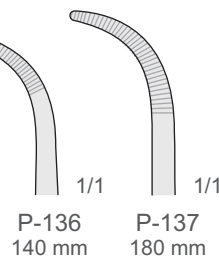

PEAN
P-250/P-253

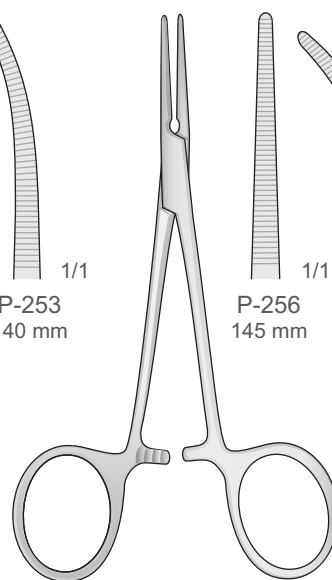
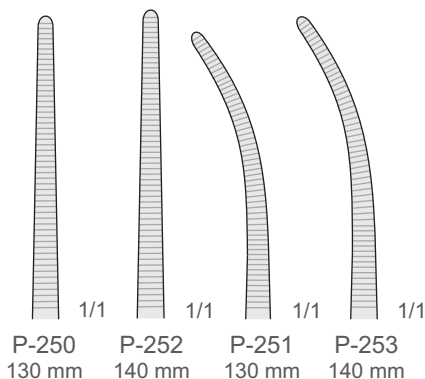

PEAN
P-256/P-257

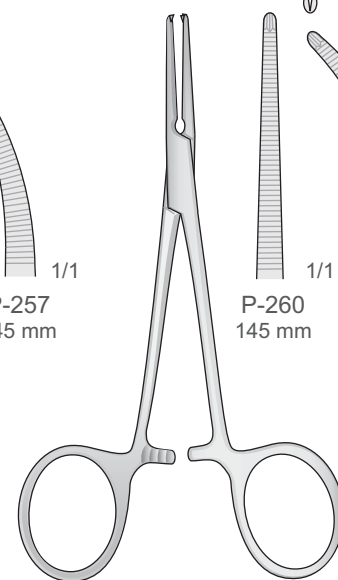
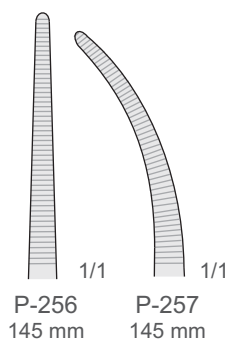

KOCHER
P-260/P-261

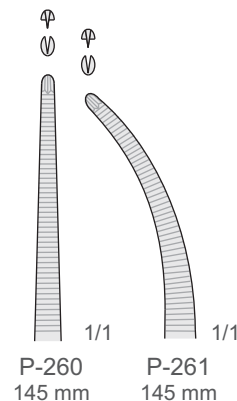

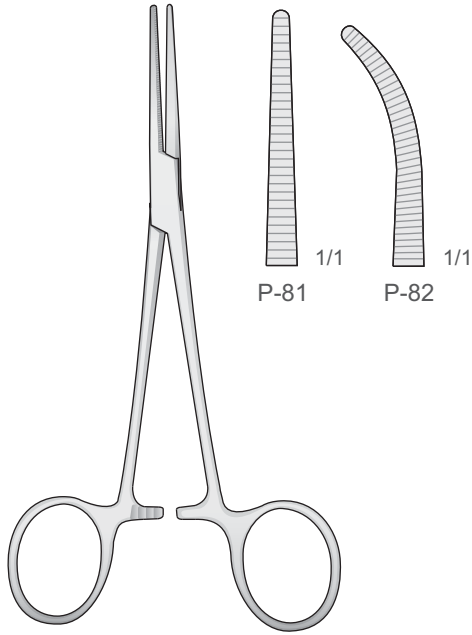

CRILE
P-81/P-82
140 mm

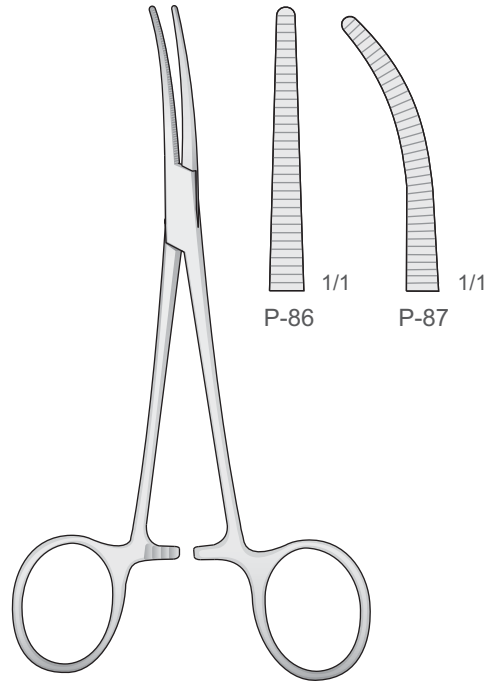

CRILE
P-86/P-87
160 mm

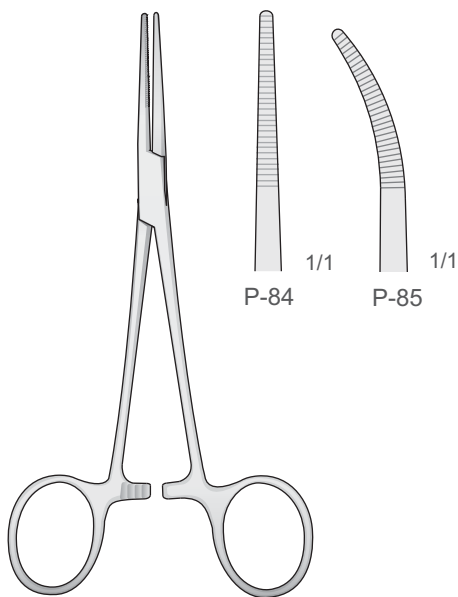

KELLY
P-84/P-85
140 mm

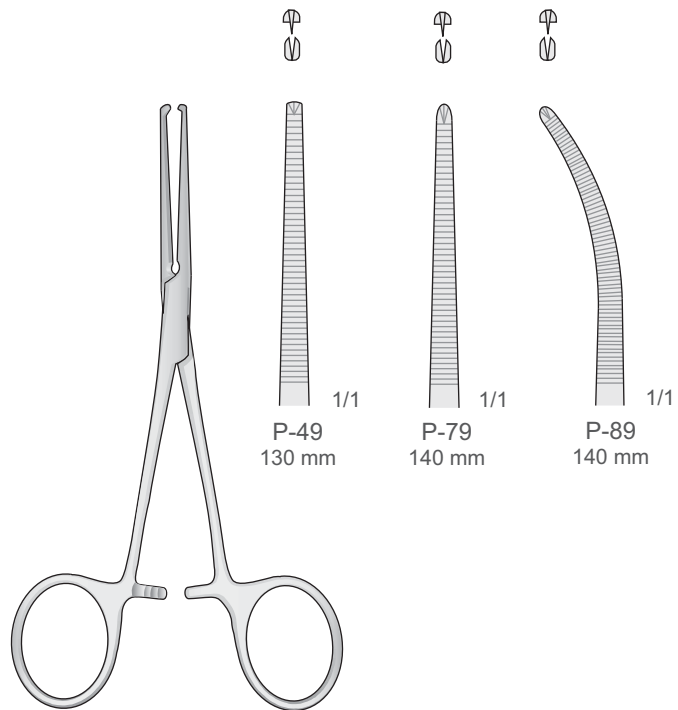

KOCHER
P-49/P-89
140 mm



Arterienklemmen
Hemostatic Forceps
Pinze emostatiche
Pinzas hemostáticas
Pinces hémostatiques

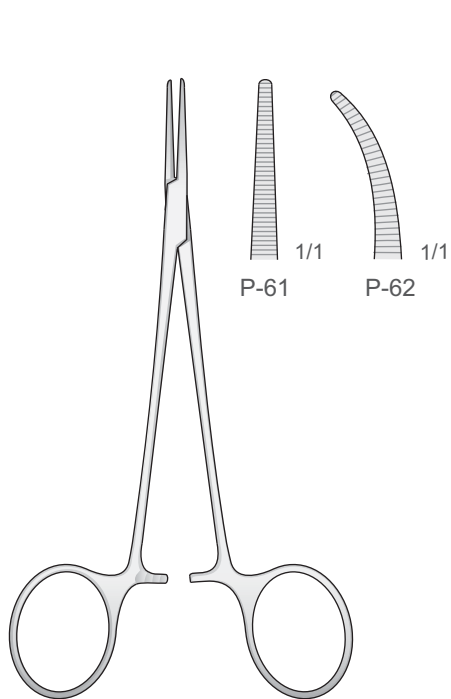

LERICHE
P-61/P-62
150 mm

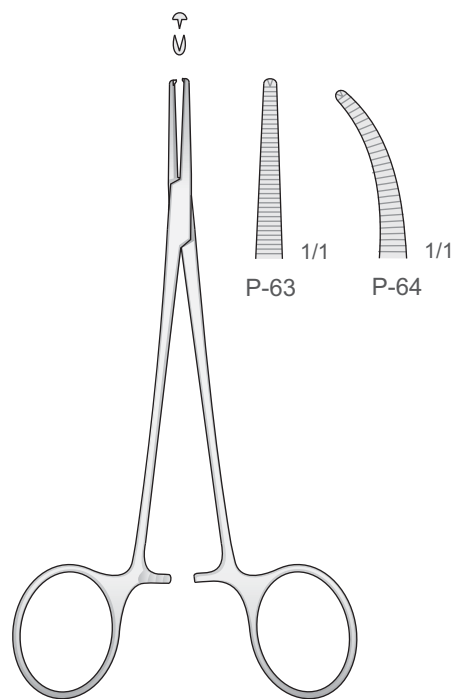

LERICHE
P-63/P-64
150 mm

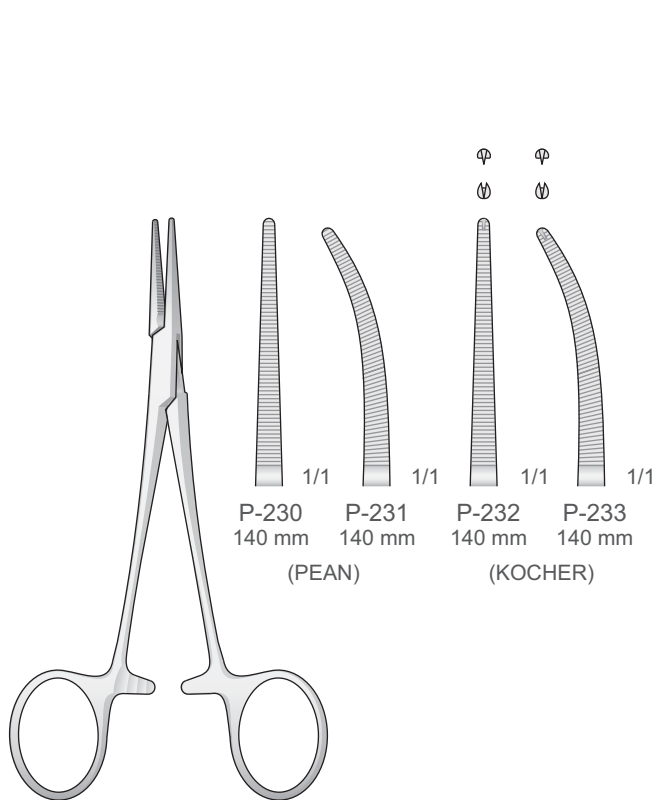

BABY-CRILE
P-230/P-233
140 mm

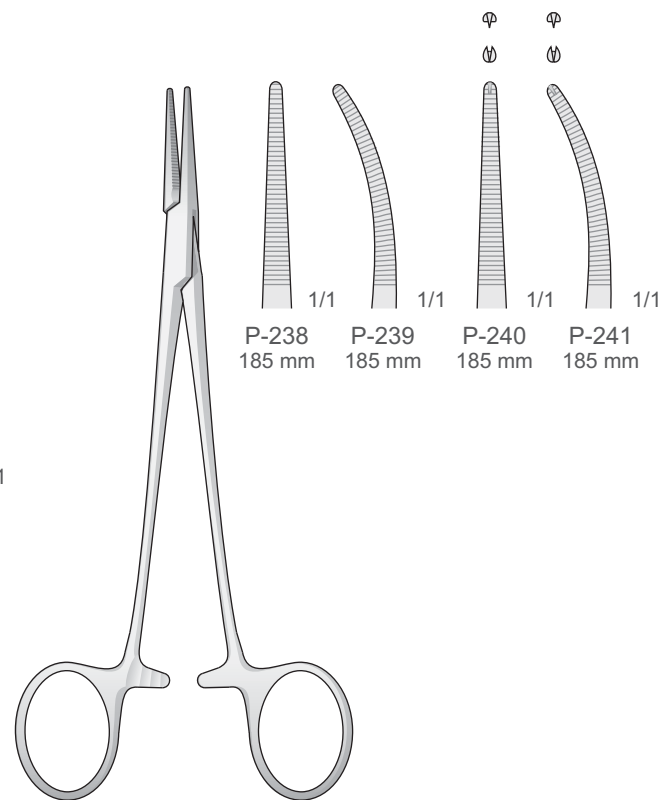

HALSTED
P-238/P-241
185 mm

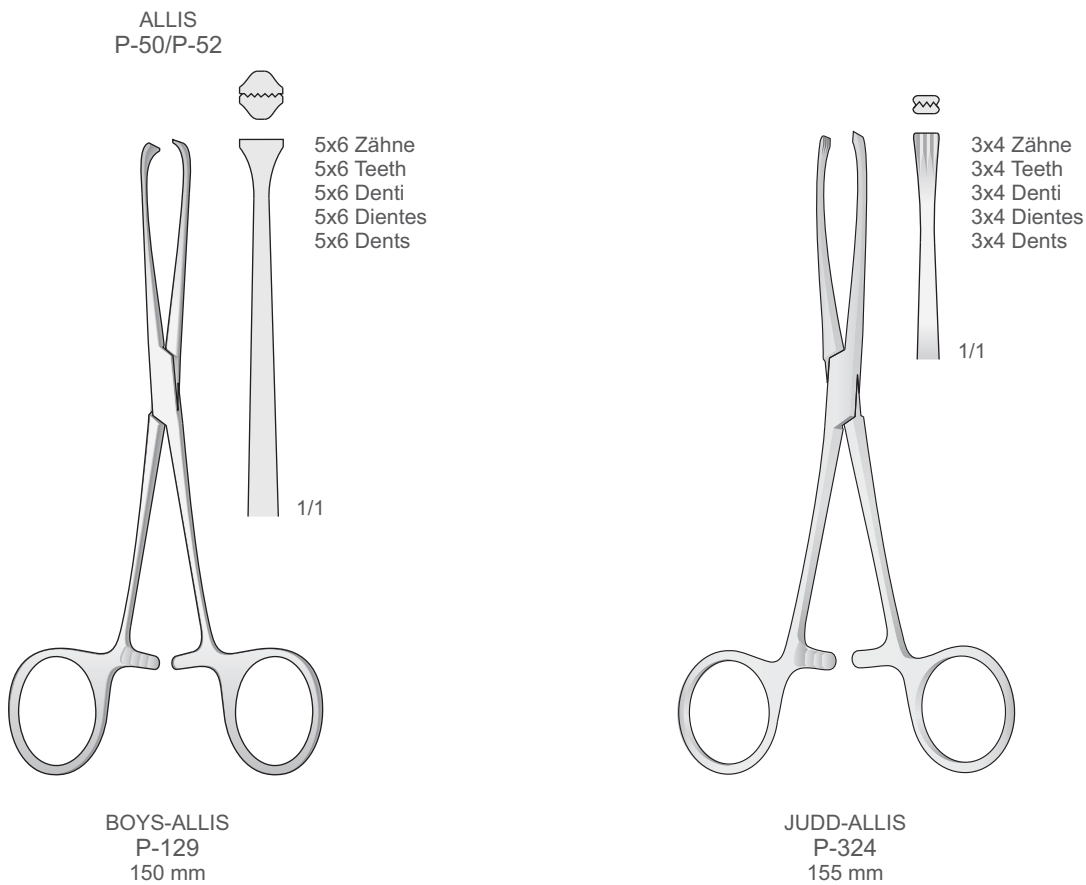
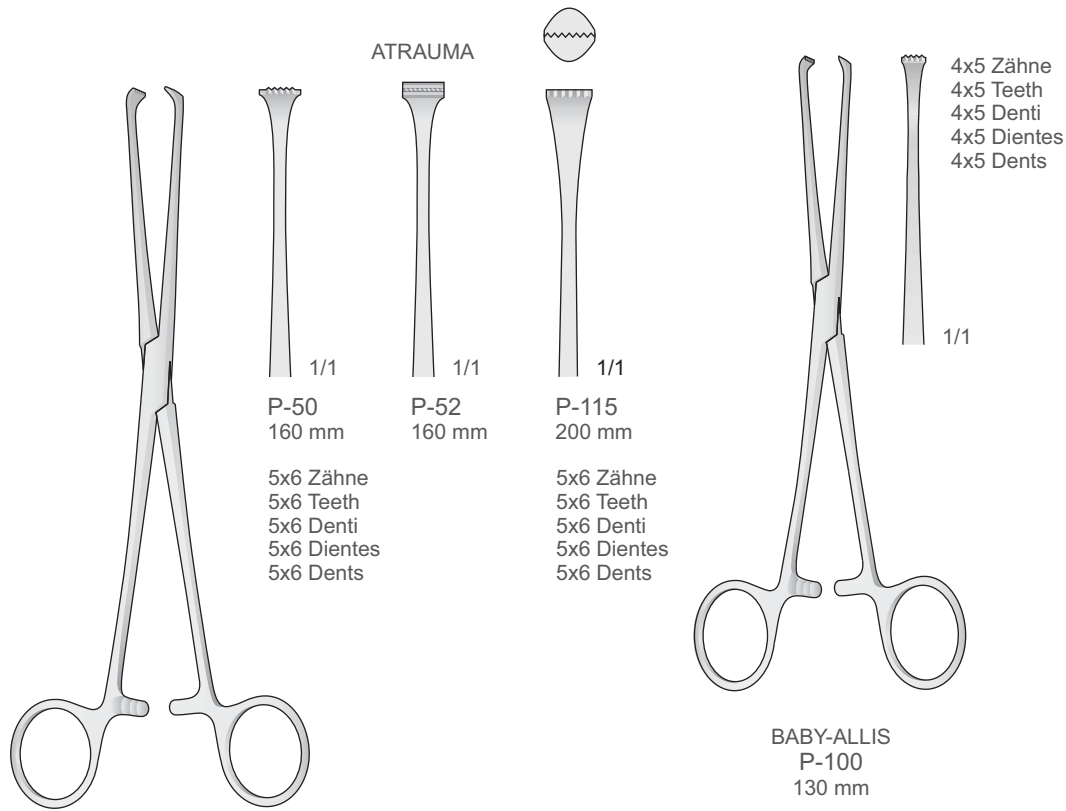



08

Retractors
Retraktoren
Écarteurs
Separadores
Divaricatori

Mouth Gags | Mouth Prop
Mundsperrer
Ouvre-bouche
Abrebocas
Apribocca

Tongue Depressor
Zungendrucker
Abaisse-langue
Bajalengua
Abbassalingua



Wundhaken
Retractors
Divaricatori
Separadores
Écarteurs

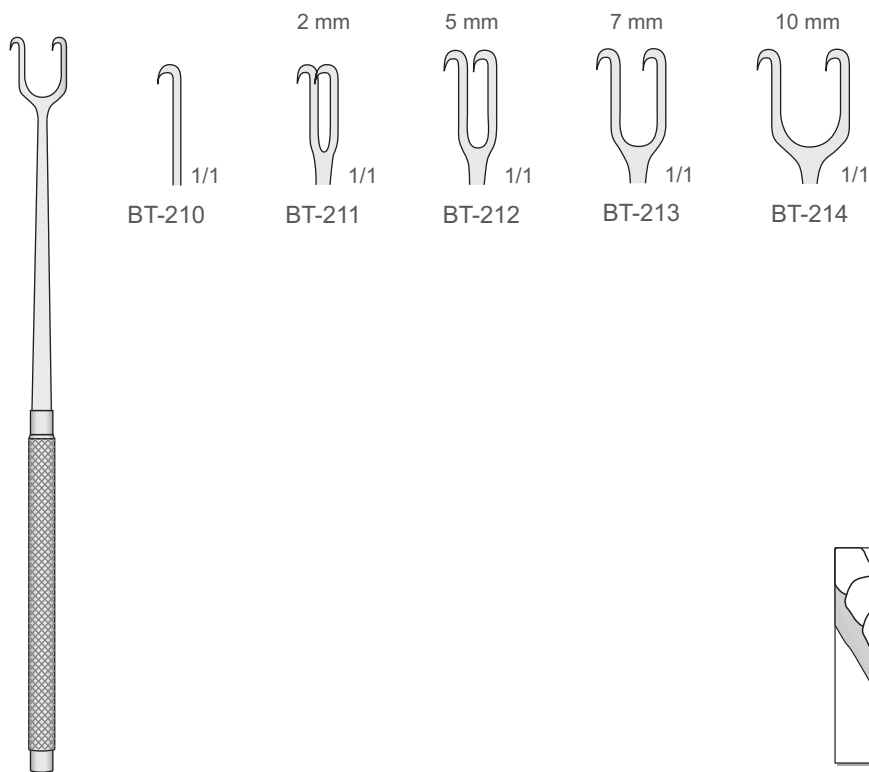

JOSEPH
BT-210/BT-214
160 mm

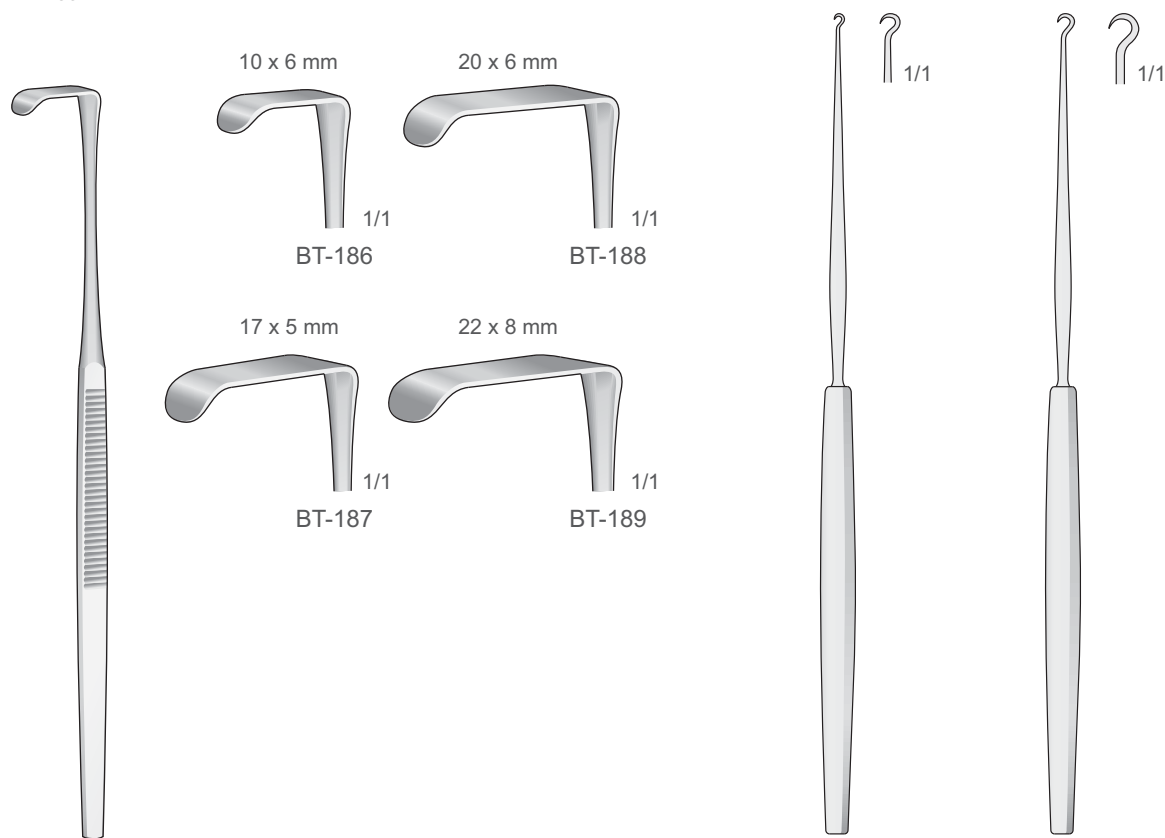

MINI-LANGENBECK
BT-186/BT-189
160 mm

GILLIES
BT-15
180 mm

GILLIES
BT-16
180 mm

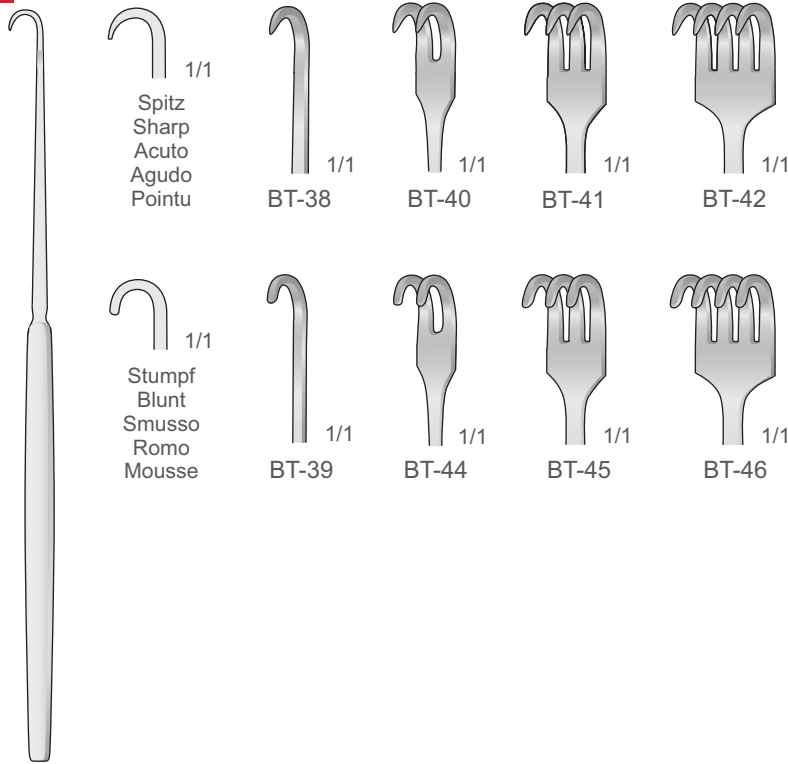

BT-38/BT-46
160 mm

Feine wundhaken flexibel-spitz
Delicate retractors flexible-sharp
Divaricatori delicati flessibili-acuti
Separadores finos flexibles-agudos
Écarteurs fins pointu flexible

Feine wundhaken flexibel-stumpf
Delicate retractors flexible-blunt
Divaricatori delicati flessibili-smussi
Separadores finos flexibles-romos
Écarteurs fins mousse flexible

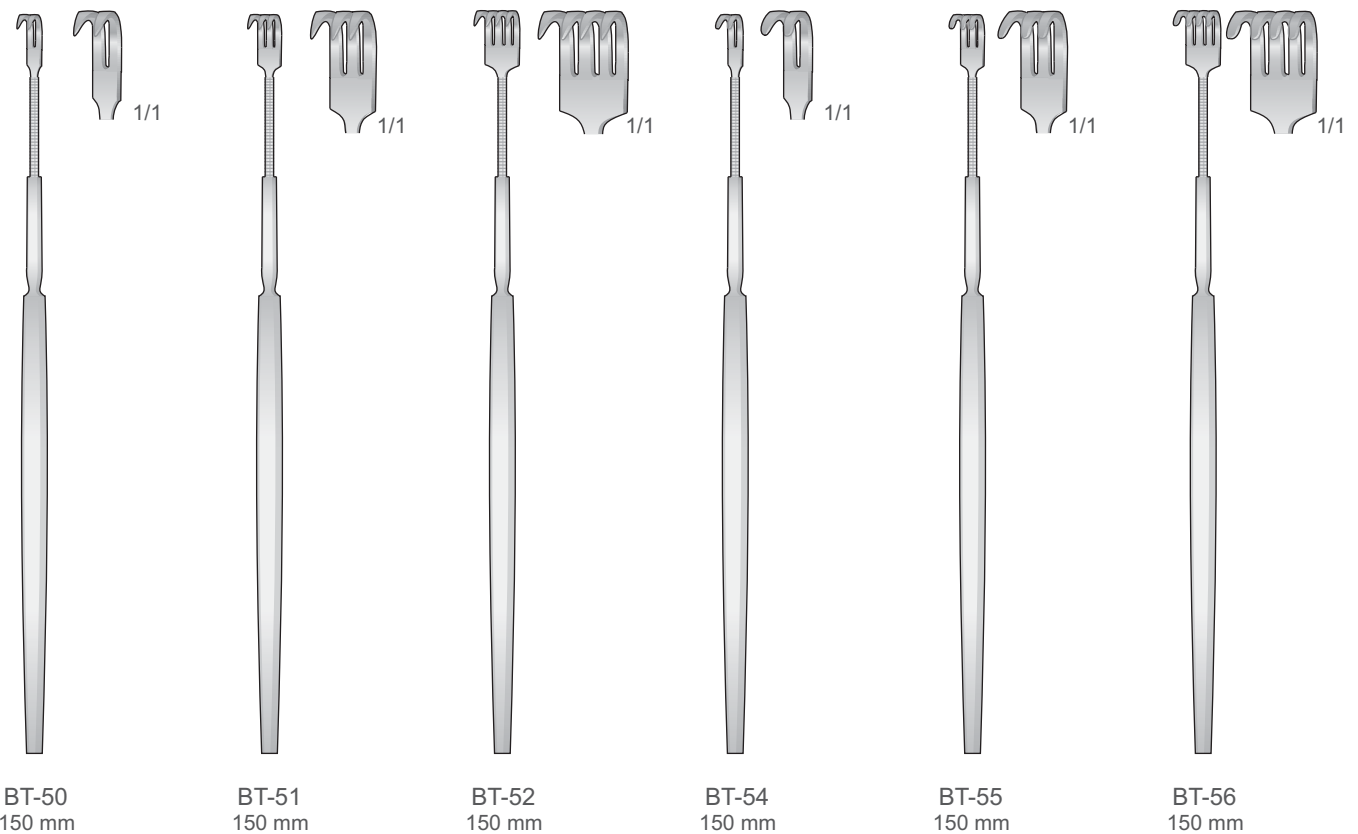

BT-50
150 mm

BT-51
150 mm

BT-52
150 mm

BT-54
150 mm

BT-55
150 mm

BT-56
150 mm



Wundhaken
Retractors
Divaricatori
Separadores
Écarteurs

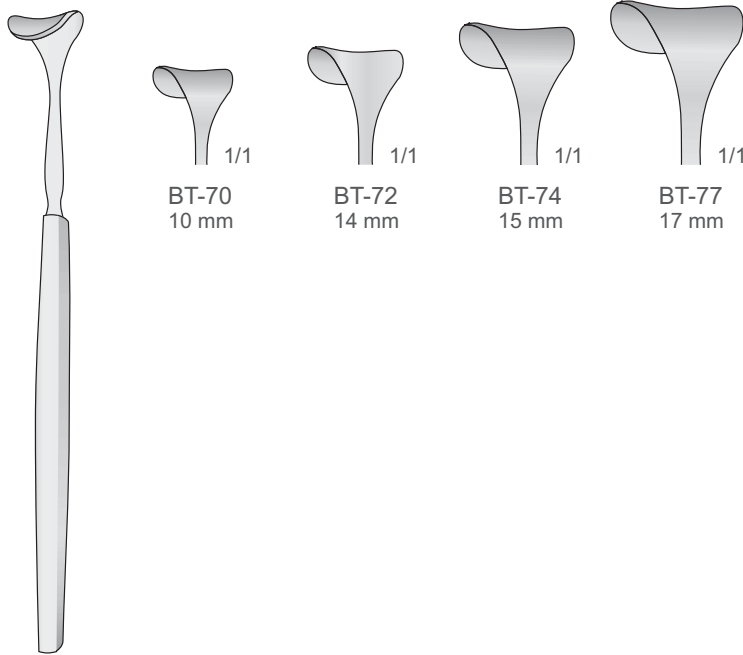

BT-70
10 mm

BT-72
14 mm

BT-74
15 mm

BT-77
17 mm

DESMARES
BT-70/BT-77
140 mm

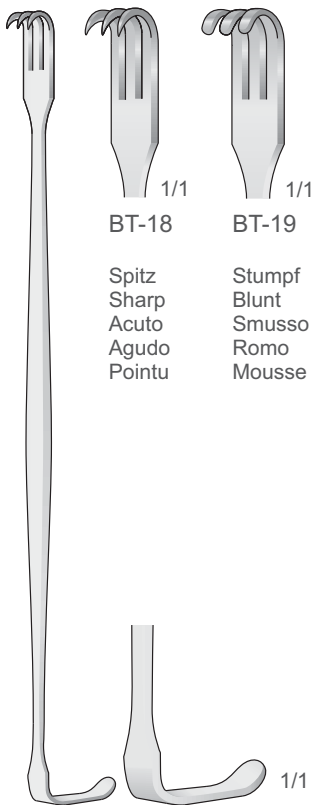

BT-18

BT-19

Spitz
Sharp
Acuto
Agudo
Pointu

Stumpf
Blunt
Smusso
Romo
Mousse

SEÁN-MILLER
BT-18/BT-19
160 mm

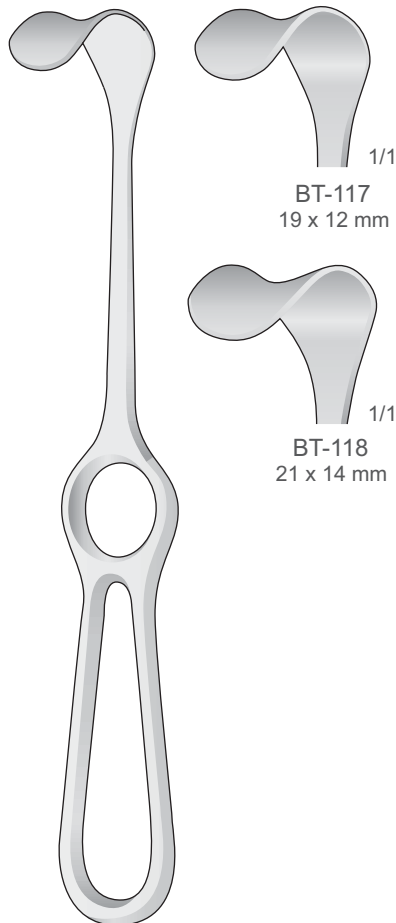

BT-117
19 x 12 mm

BT-118
21 x 14 mm

KOCHER
BT-117/BT-118
205 mm

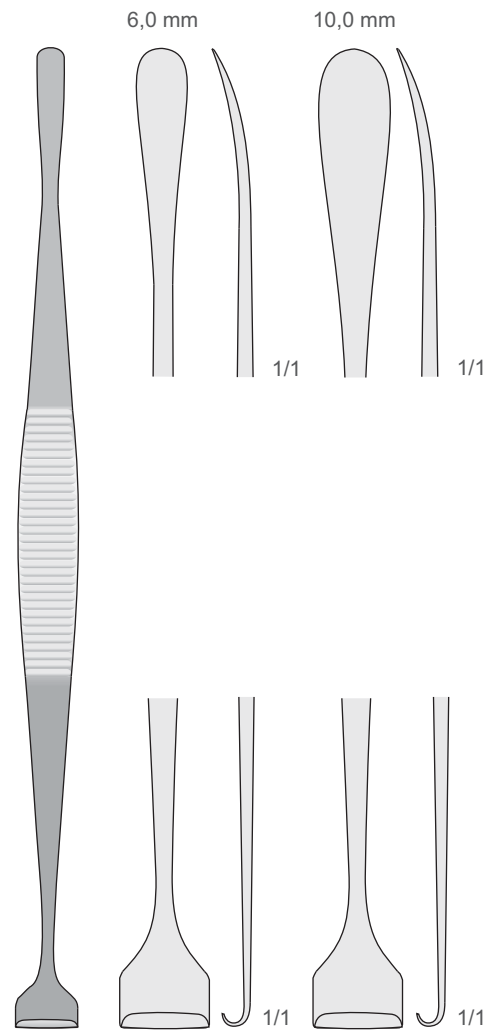

6,0 mm

10,0 mm

12 mm

12 mm

HURD
BT-1/BT-2
220 mm

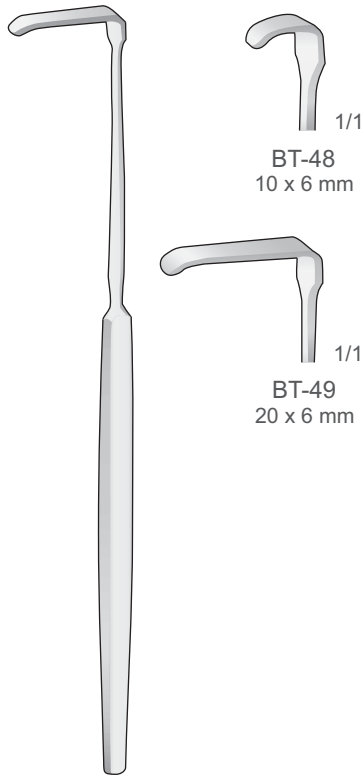

SENN GREEN
BT-48/BT-49
160 mm

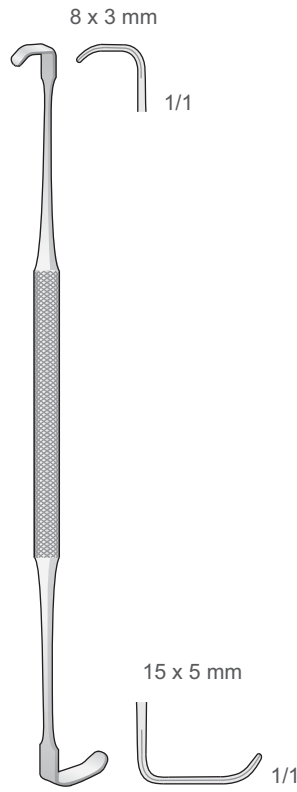

RAGNELL
BT-27
140 mm

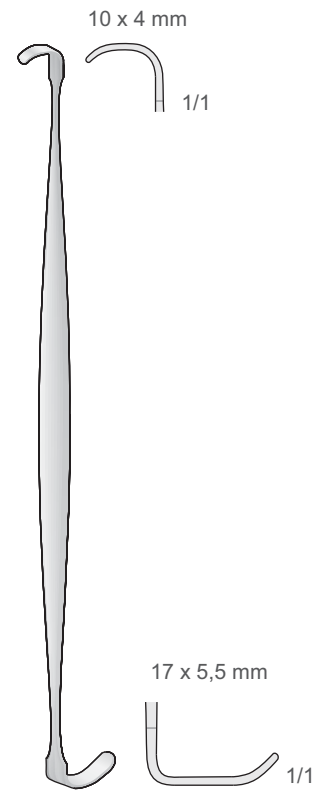

RAGNELL-DAVIS
BT-26
140 mm

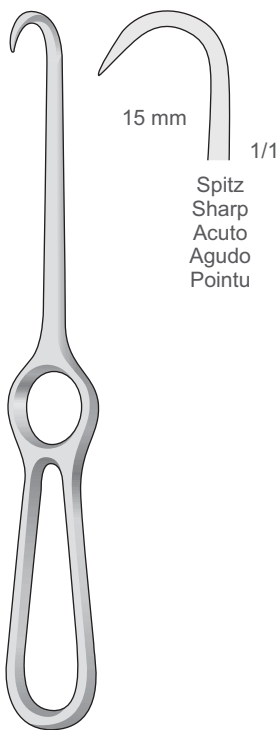

KOCHER
BT-139
205 mm

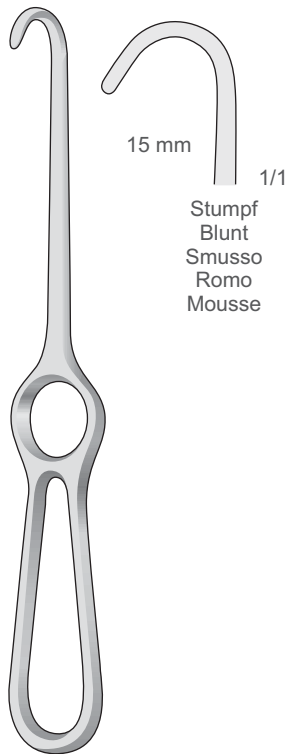

KOCHER
BT-140
220 mm



LAHEY
BT-109
195 mm

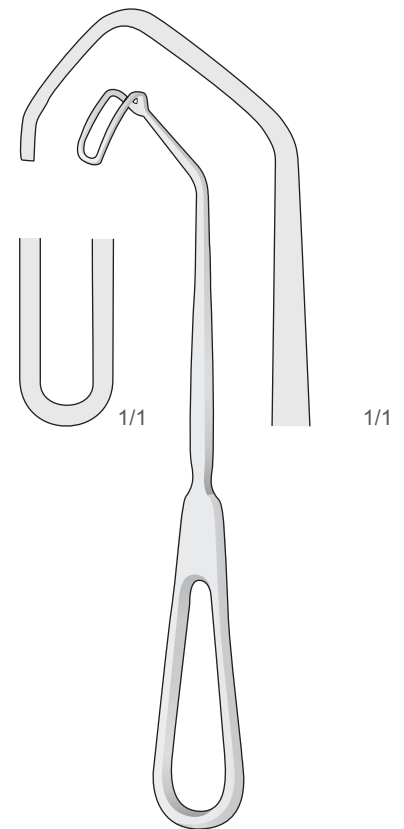

CUSHING
BT-29
200 mm



Wundhaken
Retractors
Divaricatori
Separadores
Écarteurs

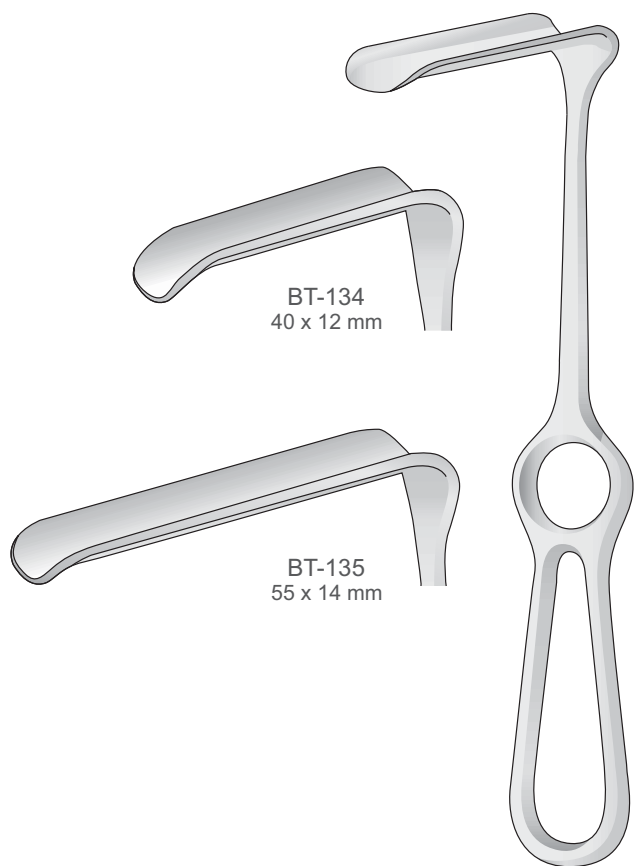
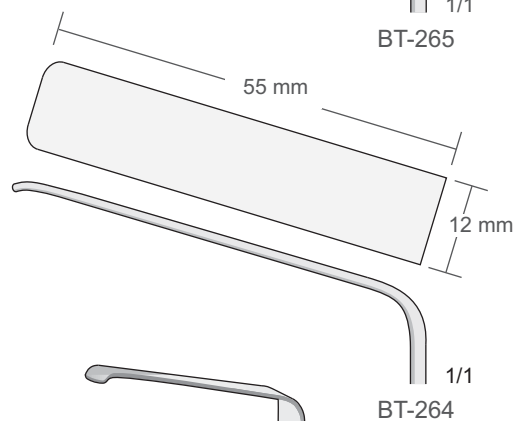
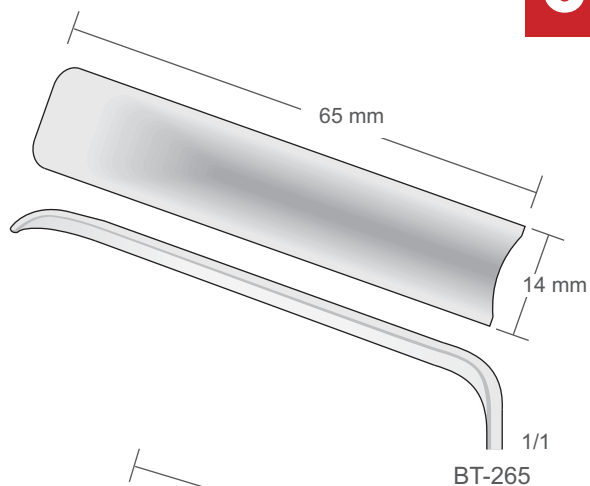

BT-134
40 x 12 mm

BT-135
55 x 14 mm

DOCKHORN
BT-134/BT-135
210 mm

BT-264/BT-265
235 mm

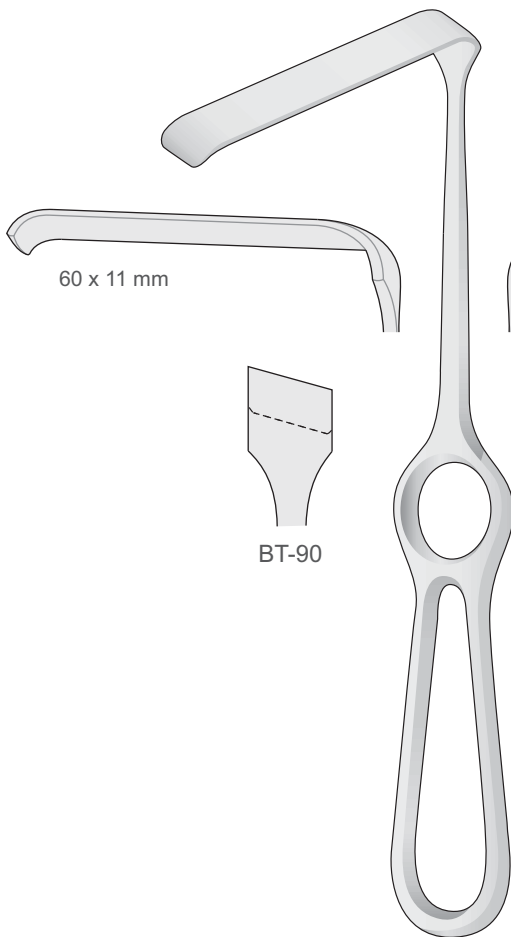

KIRSCH
BT-90/BT-91
210 mm

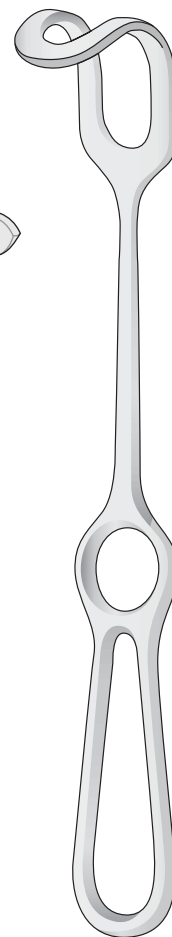
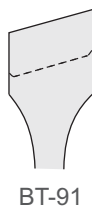
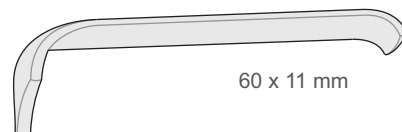

MIDDELDORPF
BT-80/BT-82
225 mm

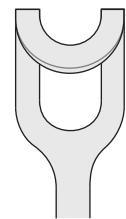

BT-80
15 x 15 mm

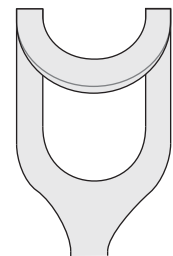

BT-81
20 x 22 mm

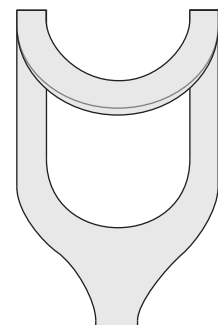

BT-82
28 x 28 mm



Wundhaken
Retractors
Divaricatori
Separadores
Écarteurs

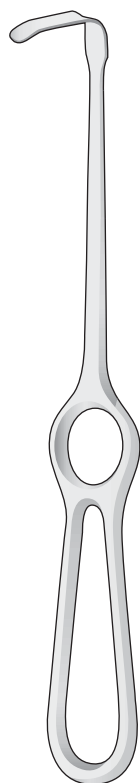

OBWEGESER
BT-152/BT-157
220 mm

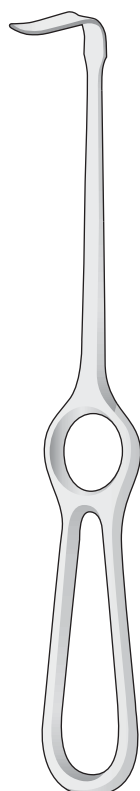

OBWEGESER
BT-92/BT-100
220 mm

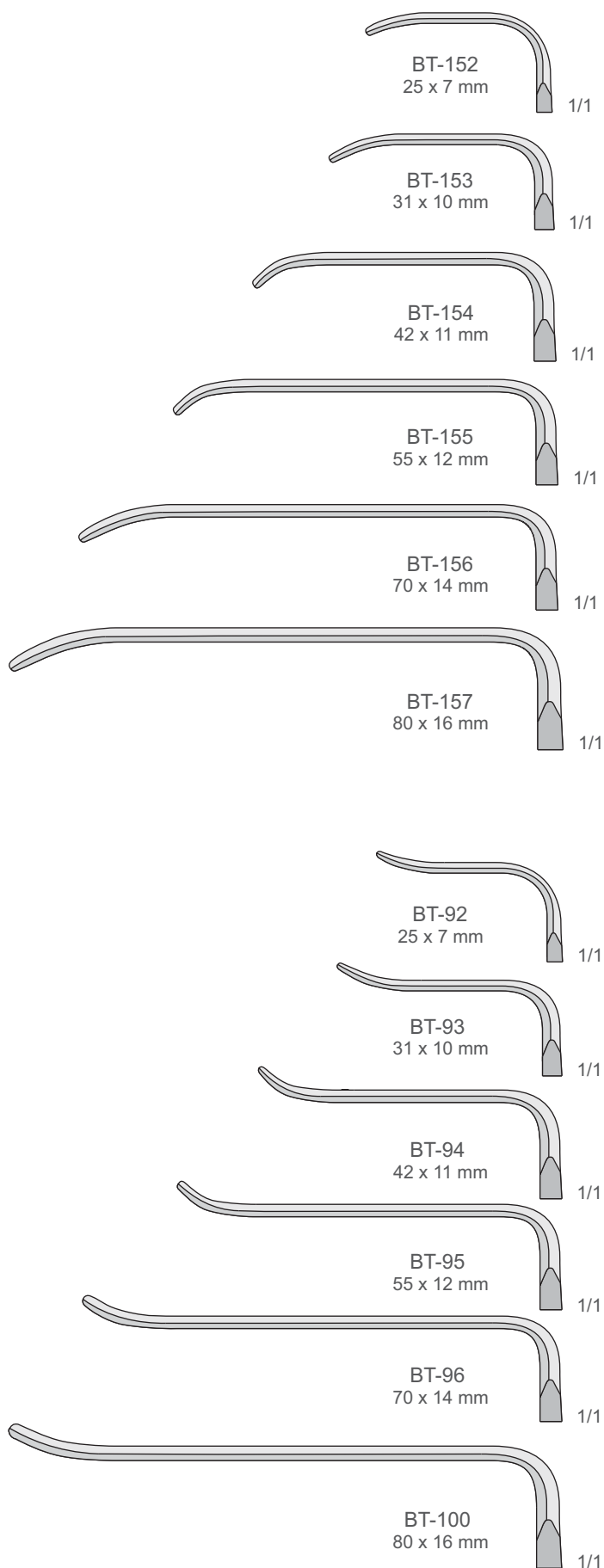

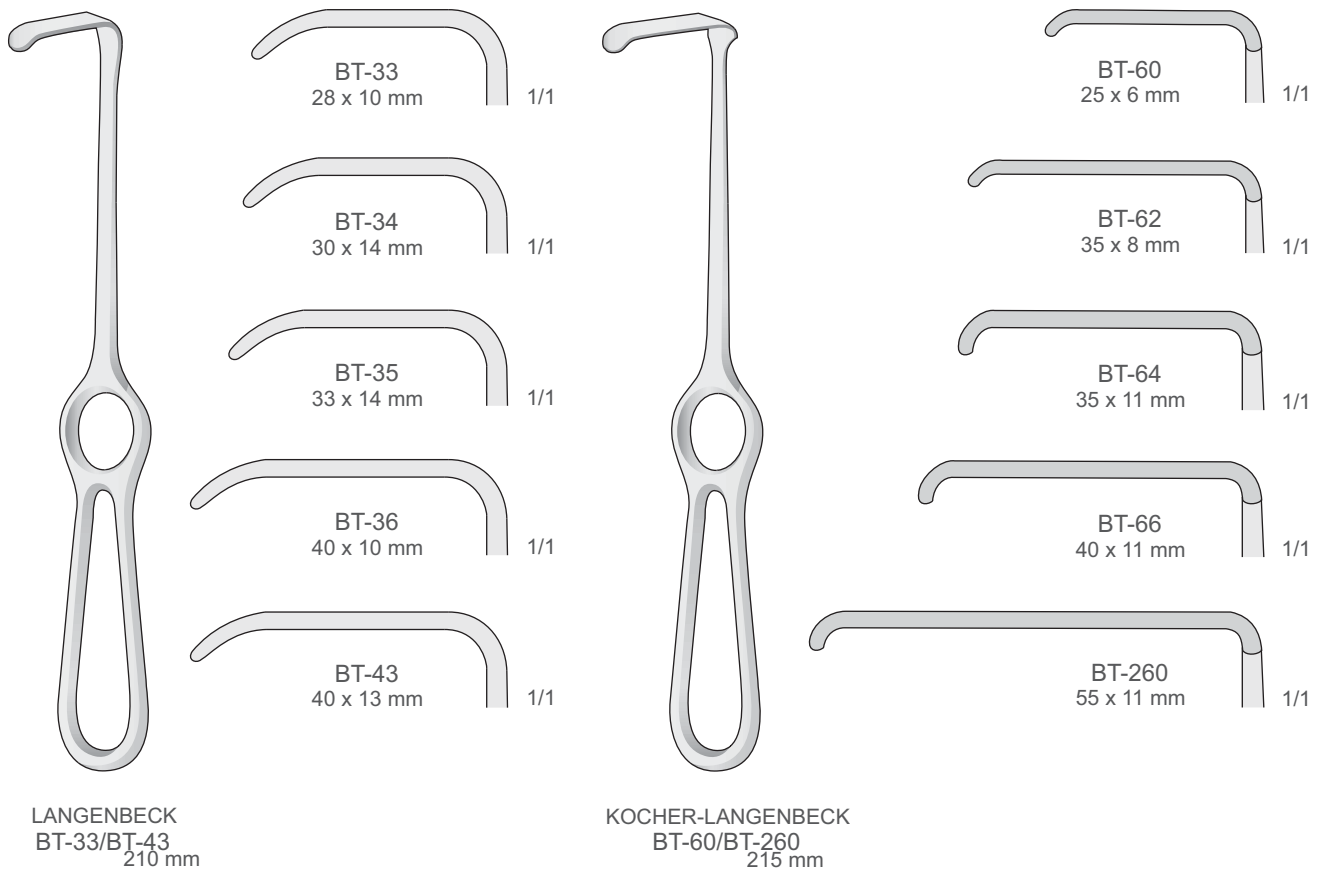
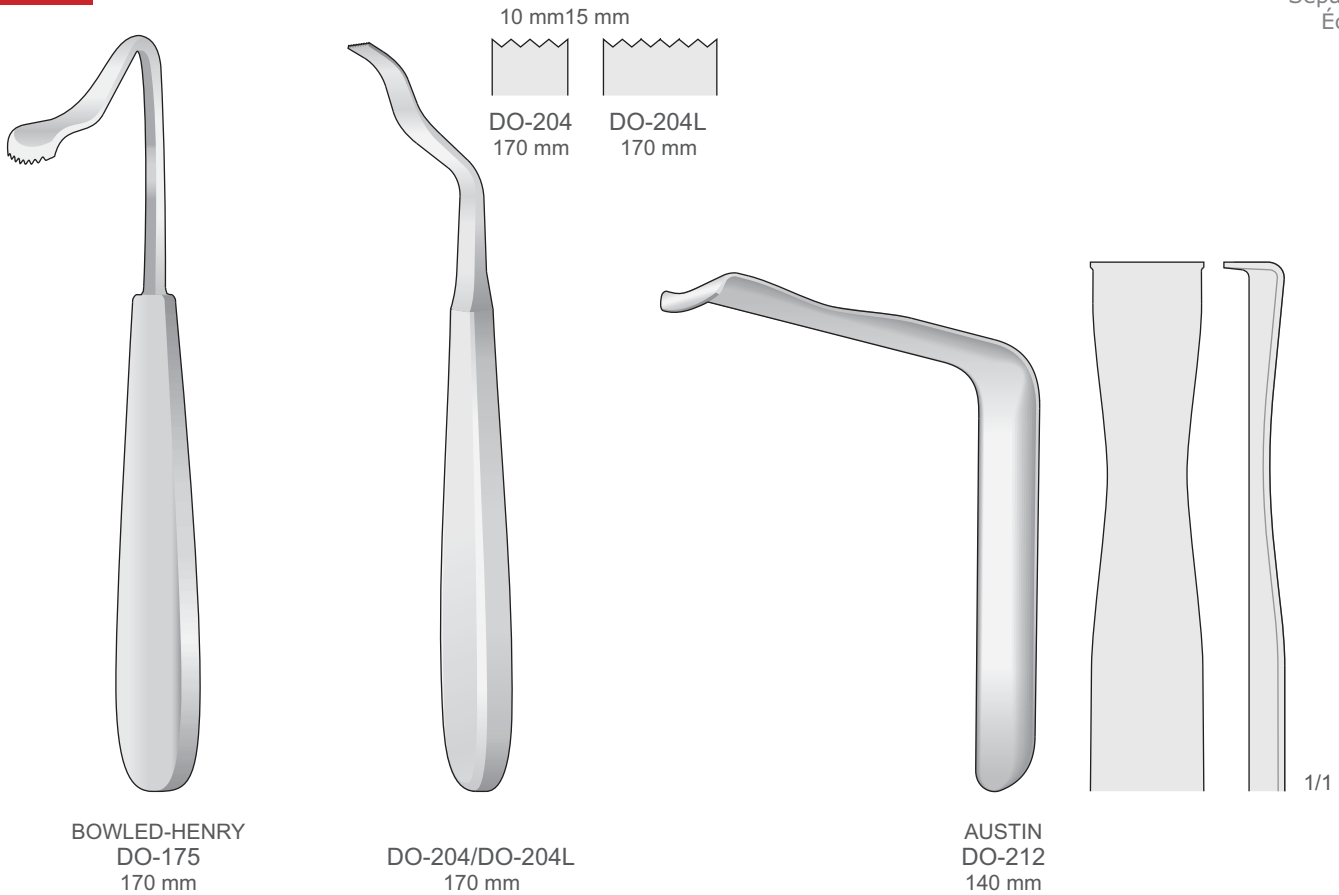



Wundhaken
Retractors
Divaricatori
Separadores
Écarteurs

08

Rostfrei - Stainless Steel
Acciaio - Acero - Acer

Biigsam - Malleable
Malleabili - Maleables
Souples

OM-85
Komplettset mit 3 Spatel
Set complete with 3 spatulas
Set completo con 3 spatole
Set completos con 3 espátulas
Set complete avec 3 spatules
OM-80 + OM-81 + OM-82

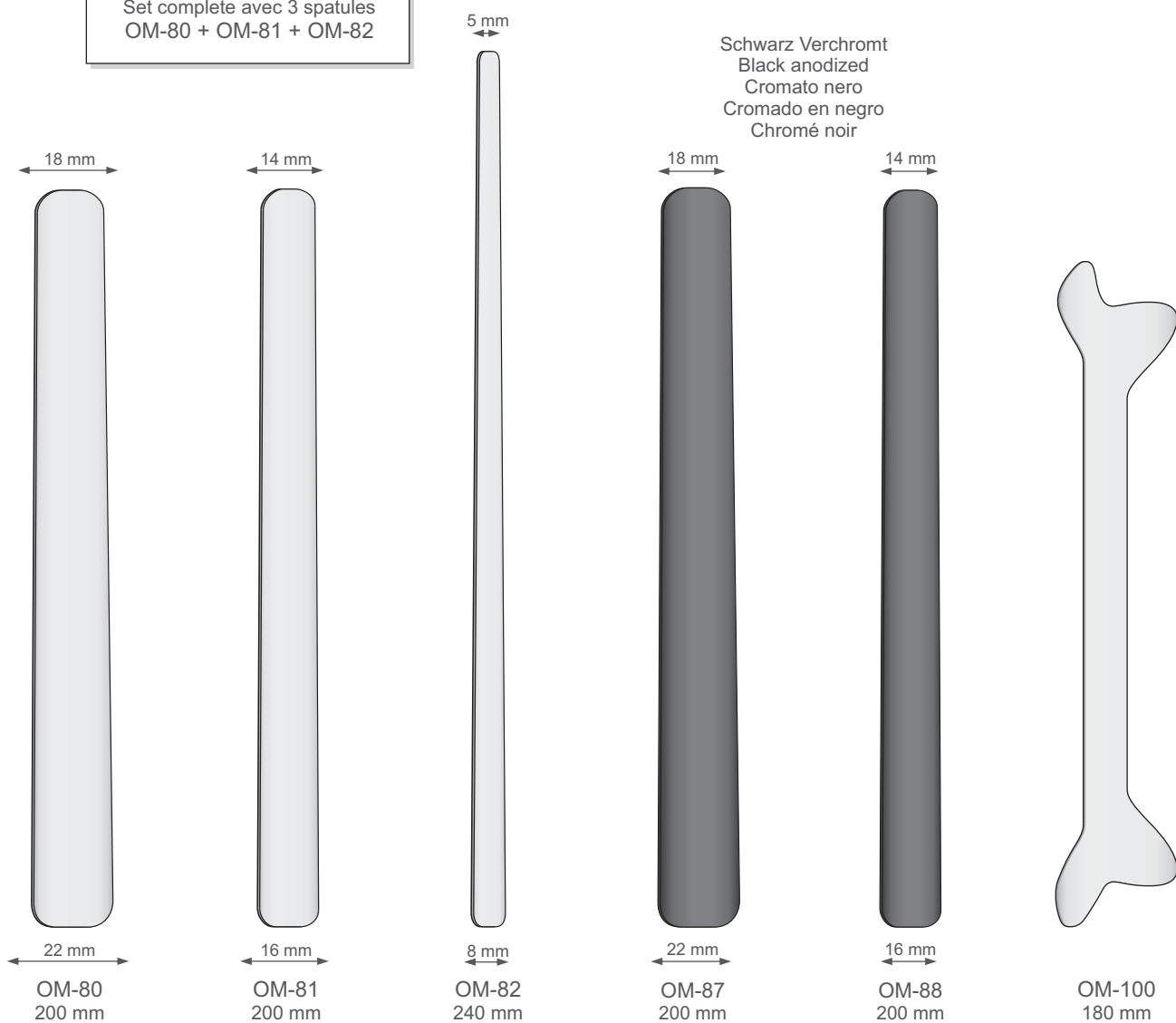

Zungendrucker
Tongue Depressors
Abbassalingua
Bajalengua
Abaisse langue

Kinnhalter
Chin Holder
Divaricatore per mento
Separador para mentón
Écarteur pour menton

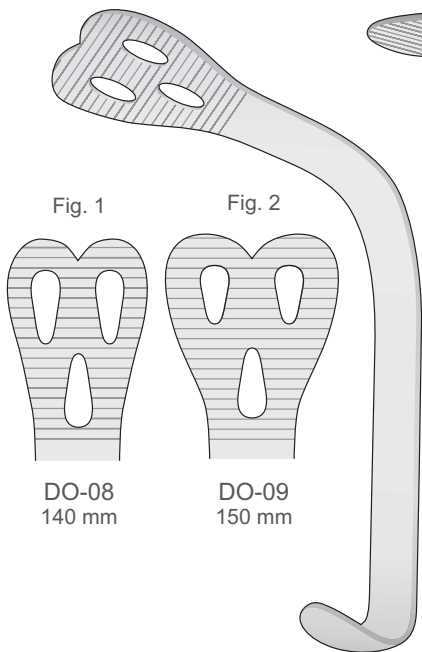
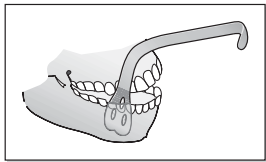

Fig. 1

Fig. 2

DO-08
140 mm

DO-09
150 mm

WIEDER
DO-08/DO-09

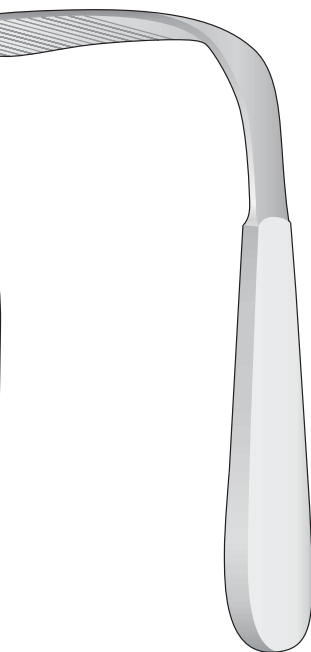

TOBOLD
OM-08
145 mm

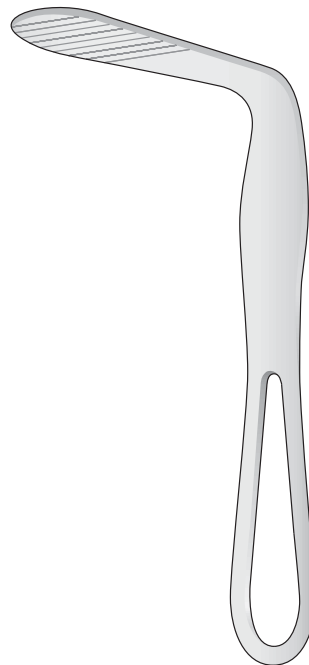

HARTMANN
OM-06
150 mm

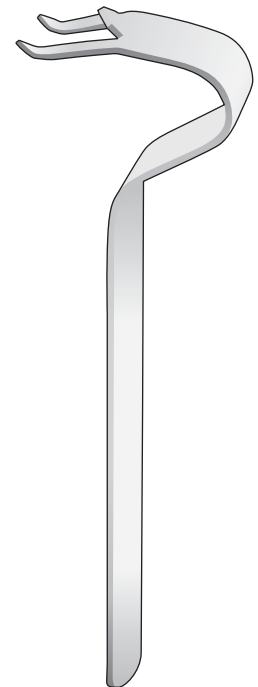

OBWEGESER
DO-40
155 mm



Wundhaken
Retractors
Divaricatori
Separadores
Écarteurs

Ramushaken für Spina Nasalis
Ramus Retractor for nasal spine
Divaricatori per spina nasalis
Separadores para spina nasalis
Écarteurs pour spina nasalis

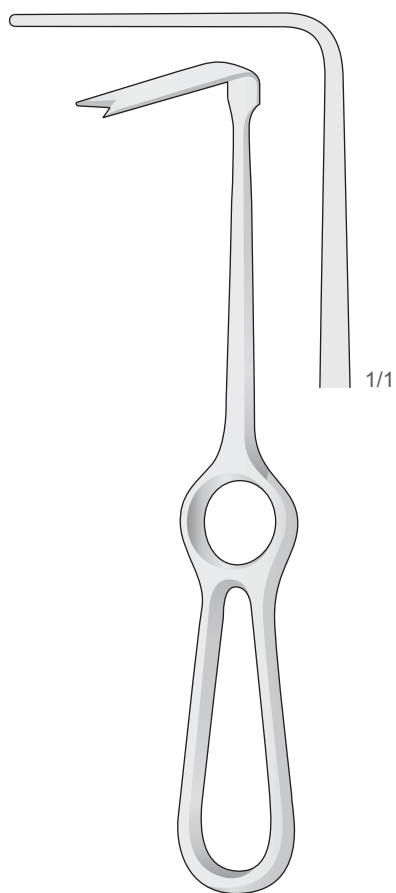
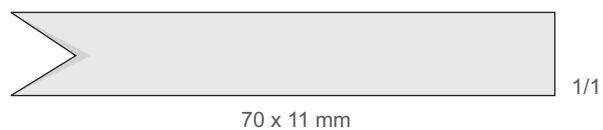
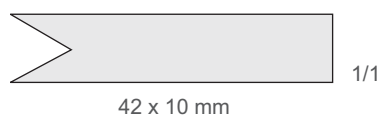

OBWEGESER
BT-67
220 mm

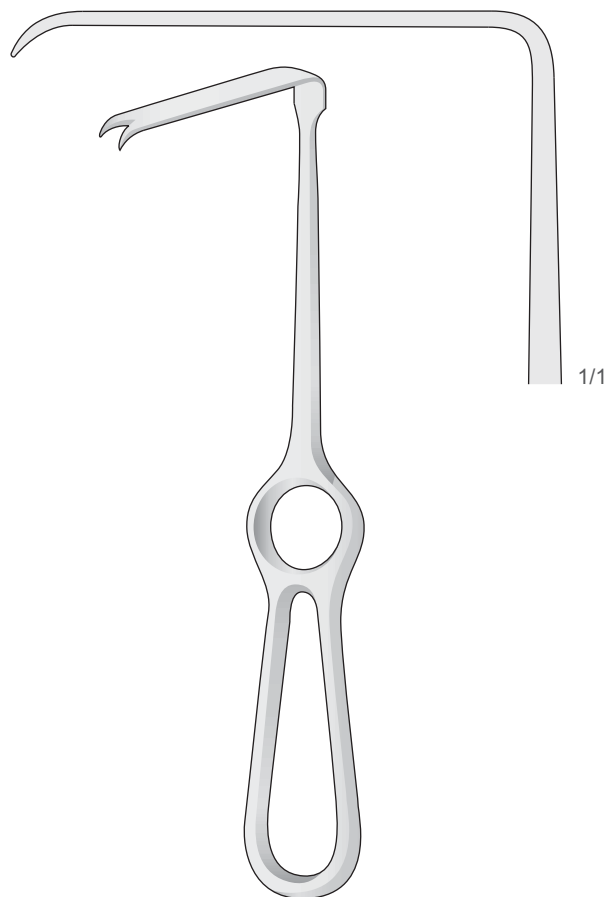

OBWEGESER
BT-68
220 mm



Paar Einsätze aus Silikon für:
Pair of silicone inserts for:
Coppia di inserti in silicone per:
Pareja de inserto de silicone para:
Paire de inserts en silicon pour:

OM-40 - OM-41

Ø 8 mm

Ø 11 mm



OM-40R
30 mm



OM-41R
30 mm

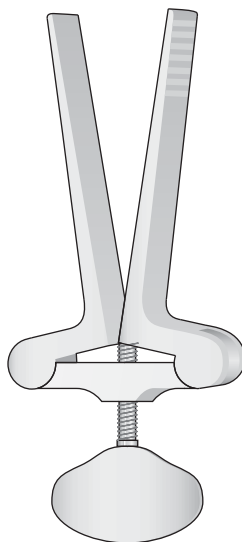

HEISTER
OM-62
135 mm

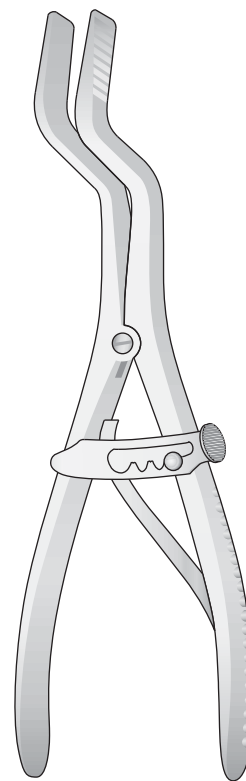

ROSER KÖNIG
OM-60
185 mm

Für Erwachsene - For adults
Per adulti - Para adultos
Pour adultes

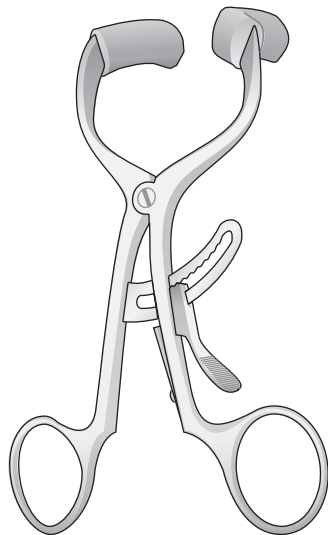

MOLT
DOYEN-JANSEN
OM-41
140 mm

Für Erwachsene - For adults
Per adulti - Para adultos
Pour adultes

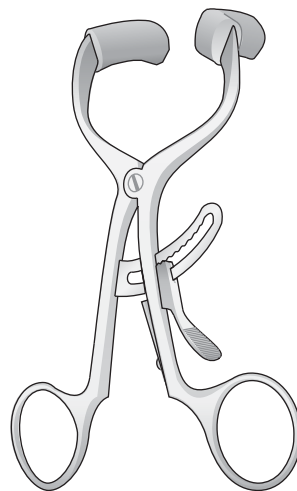

MOLT
DOYEN-COLLIN
OM-40
120 mm

Für kinder
For children
Per bambini
Para niños
Pour enfants

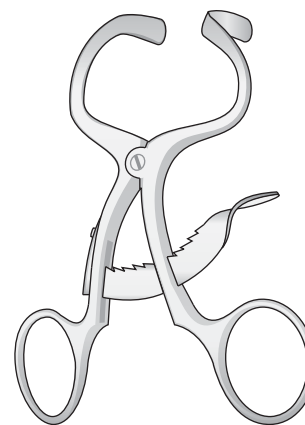

MOLT
OM-42
100 mm



Mundsperrer
Mouth gags
Apribocca
Abrebocas
Écarteur buccal

Abhalter für gesamten Ober-bzw. Unterkiefer
Retractor for complete upper resp. Lower jaws
Retrattore per arcata superiore e inferiore intera
Separadores para quijadas enteras inferiores y superiores
Écarteurs pour machoires complètes inférieures et supérieures

OM-74 Fig. 0 100 x 95 mm
OM-75 Fig. 1 115 x 105 mm
OM-76 Fig. 2 115 x 110 mm
OM-77 Fig. 3 125 x 115 mm

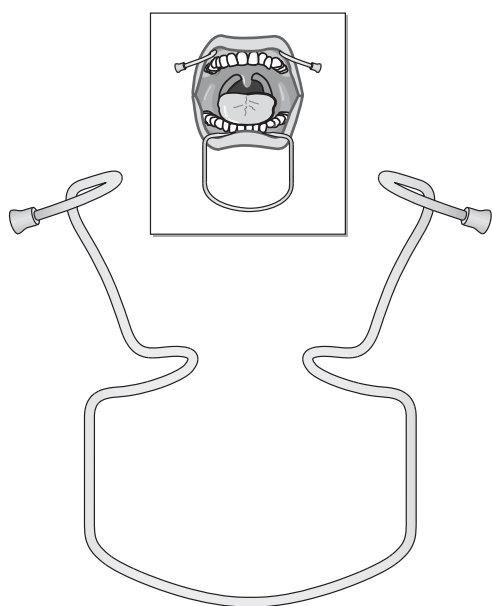

ORINGER
OM-74/OM-77

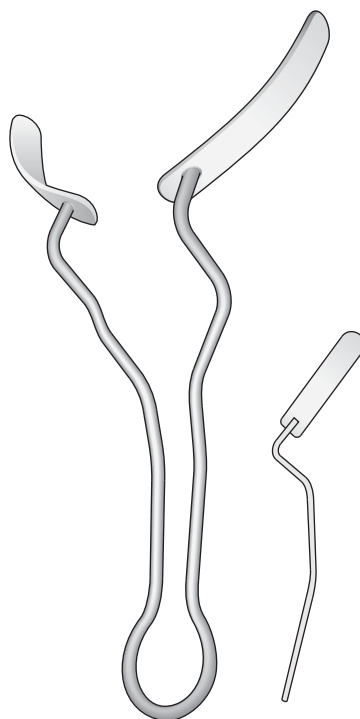

MATY
OM-97
170 mm

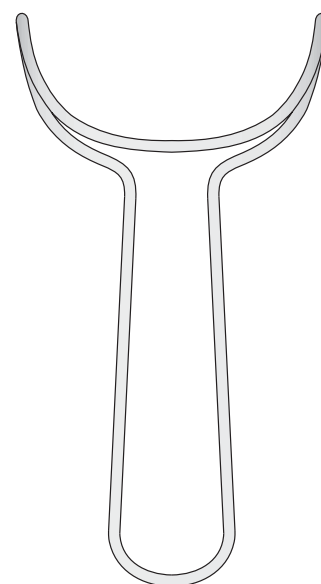

OM-90
150 mm

BT-283
Set completo
Set complete
Kompletset
Set complet
Set completo
BT-284 + BT-285 + BT-286

29 mm
26 mm
22 mm

28 mm
38 mm
44 mm

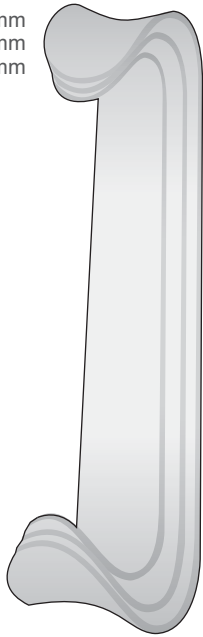

ROUX
BT-283
165 mm



ROUX
BT-284
20x22 mm
25x28 mm

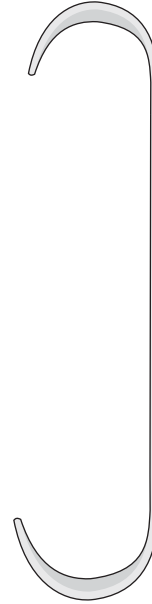

ROUX
BT-285
23x26 mm
29x38 mm



ROUX
BT-286
29x29 mm
34x44 mm

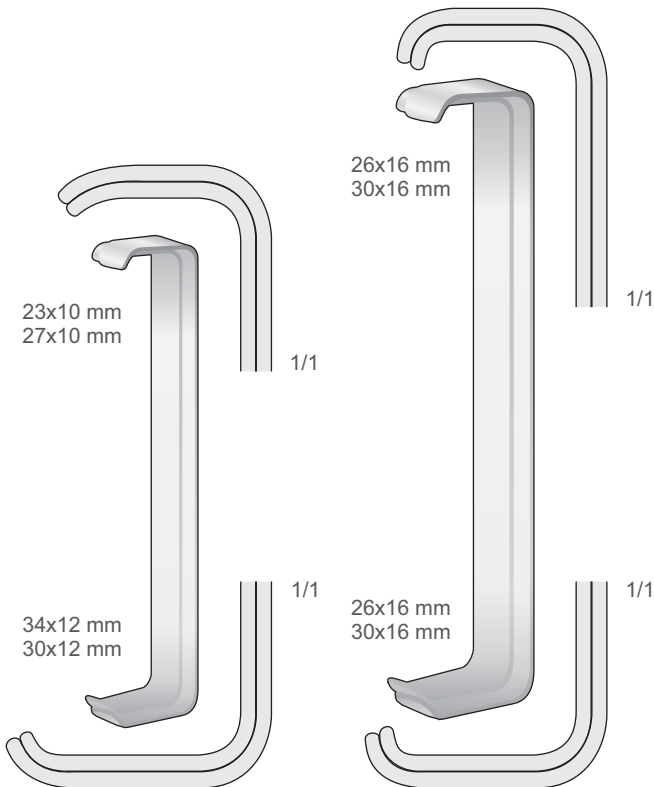

23x10 mm
27x10 mm

26x16 mm
30x16 mm

20x22 mm

23x26 mm

29x29 mm

34x12 mm
30x12 mm

26x16 mm
30x16 mm

25x28 mm

29x38 mm

34x44 mm

FARABEUF
BT-20
120 mm

FARABEUF
BT-25
150 mm

ROUX-MAGNUS
BT-287
150 mm

ROUX-MAGNUS
BT-288
160 mm

ROUX-MAGNUS
BT-289
170 mm



Wangenhalter
Cheek Retractors
Divaricatori per guance
Separador para mejillas
Écarteurs des joues

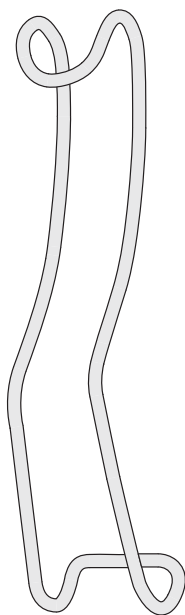

STERNBERG
OM-50
160 mm



STERNBERG
OM-52
160 mm

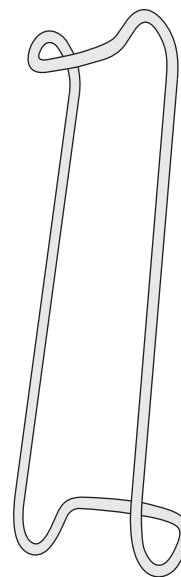

COLUMBIA
OM-67
140 mm

22 mm

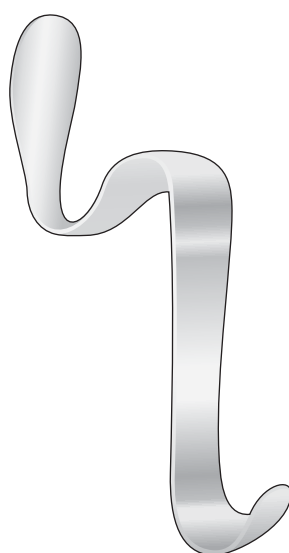

BISHOP
OM-61
130 mm



MINNESOTA
OM-55
140 mm



CAWOOD-MINNESOTA
OM-66
160 mm

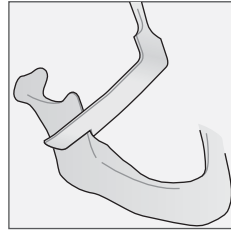

Ramus Retraktoren Recht
Ramus Retractor Right
Retrattore Ramus destro
Separadores Ramus derecho
Écarteur Ramus droites

Ramus Retraktoren Link
Ramus Retractor Left
Retrattore Ramus sinistro
Separadores Ramus izquierdo
Écarteur Ramus gauches

8 mm

10 mm

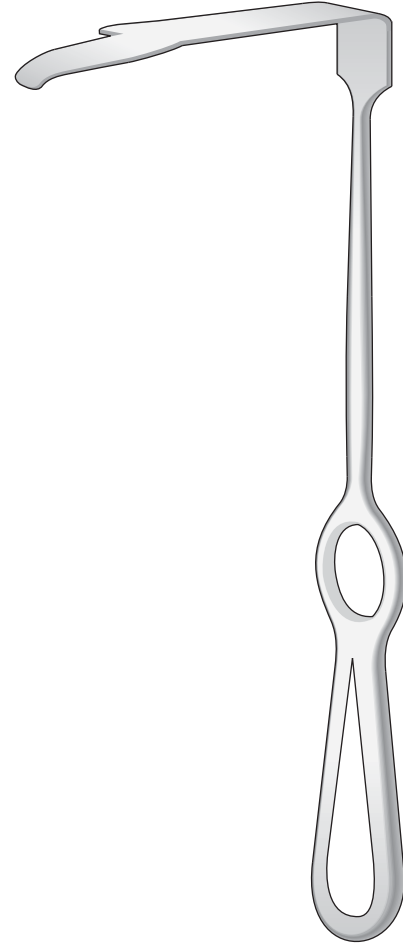
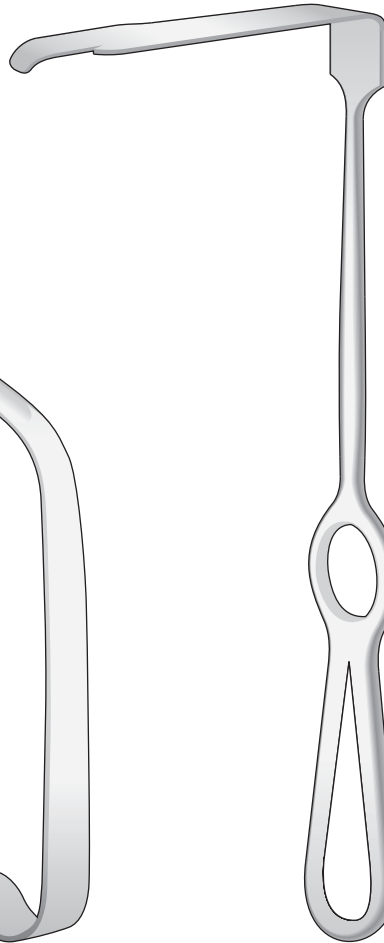
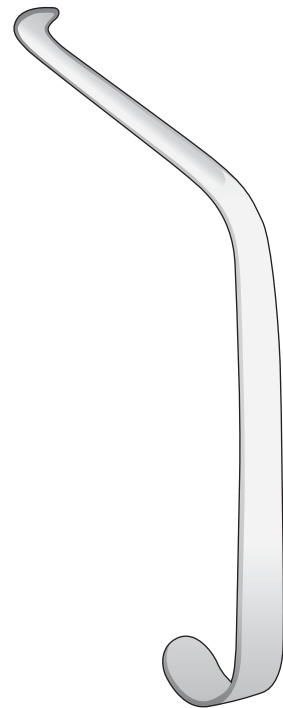
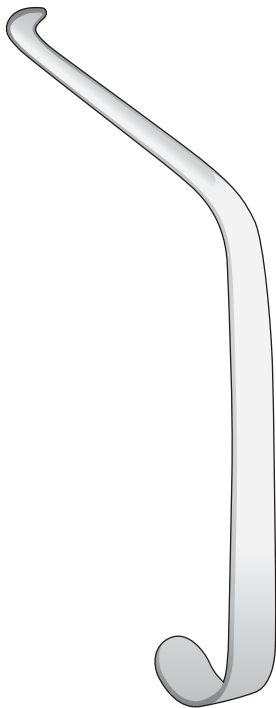

OBWEGESER
DO-41
165 mm

OBWEGESER
DO-142
165 mm

MISCH
BT-158
210 mm

MISCH
BT-159
210 mm



Mundsperrer
Mouth Gags
Apribocca
Abrebocas
Écarteur buccal

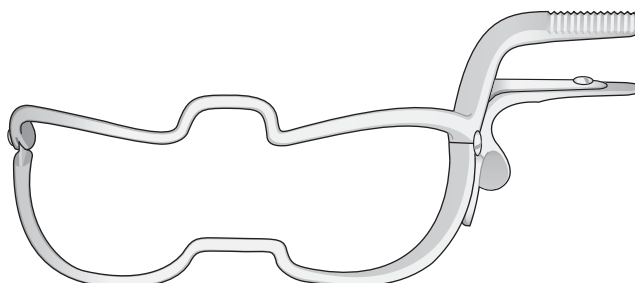

WHITEHEAD-JENNINGS

- OM-136 90 mm
- OM-137 110 mm
- OM-138 130 mm
- OM-139 150 mm

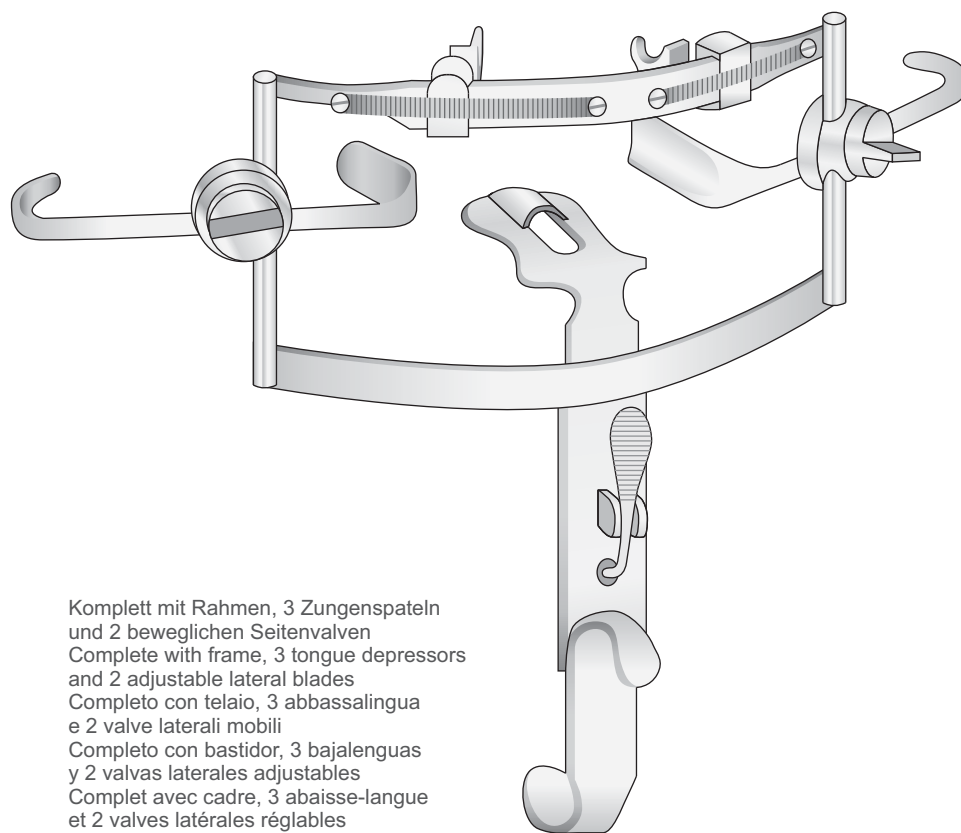

Komplett mit Rahmen, 3 Zungenspateln
und 2 beweglichen Seitenvallen
Complete with frame, 3 tongue depressors
and 2 adjustable lateral blades
Completo con telaio, 3 abbassalingua
e 2 valve laterali mobili
Completo con bastidor, 3 bajalenguas
y 2 valvas laterales ajustables
Complet avec cadre, 3 abaisse-langue
et 2 valves latérales réglables

DINGMANN
OM-110
Set completo

DINGMANN

Zungenspatel
Tongue depressor
Abbassalingua
Bajalengua
Abaisse langue

Fig. 1

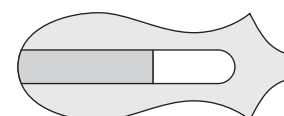

OM-112
65 x 25 mm

Fig. 2

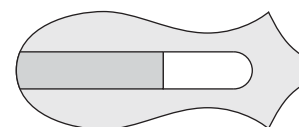

OM-113
70 x 29 mm

Fig. 3

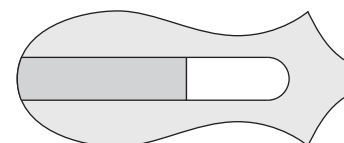

OM-114
80 x 32 mm

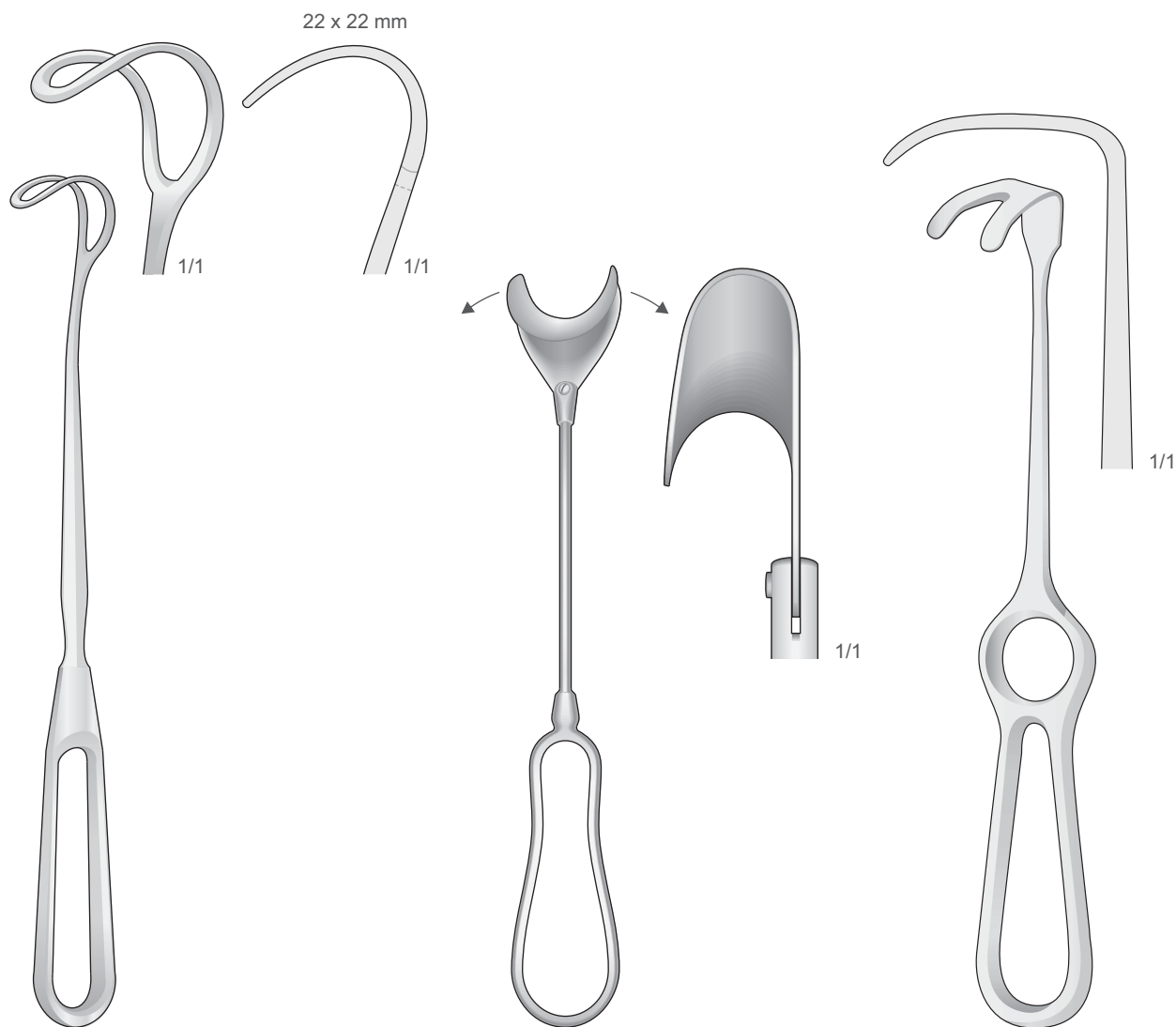

GREENE
BT-131
225 mm

BT-132
200 mm

WASSMUND
BT-69
220 mm



Zungenspatel - Zungenzangen
Tongue Depressors - Tongue Holding Forceps
Abbassalingua - Pinze tiralingua
Bajalenguas - Pinzas tira-lengua
Abaisse langues - Pincés tire-langue

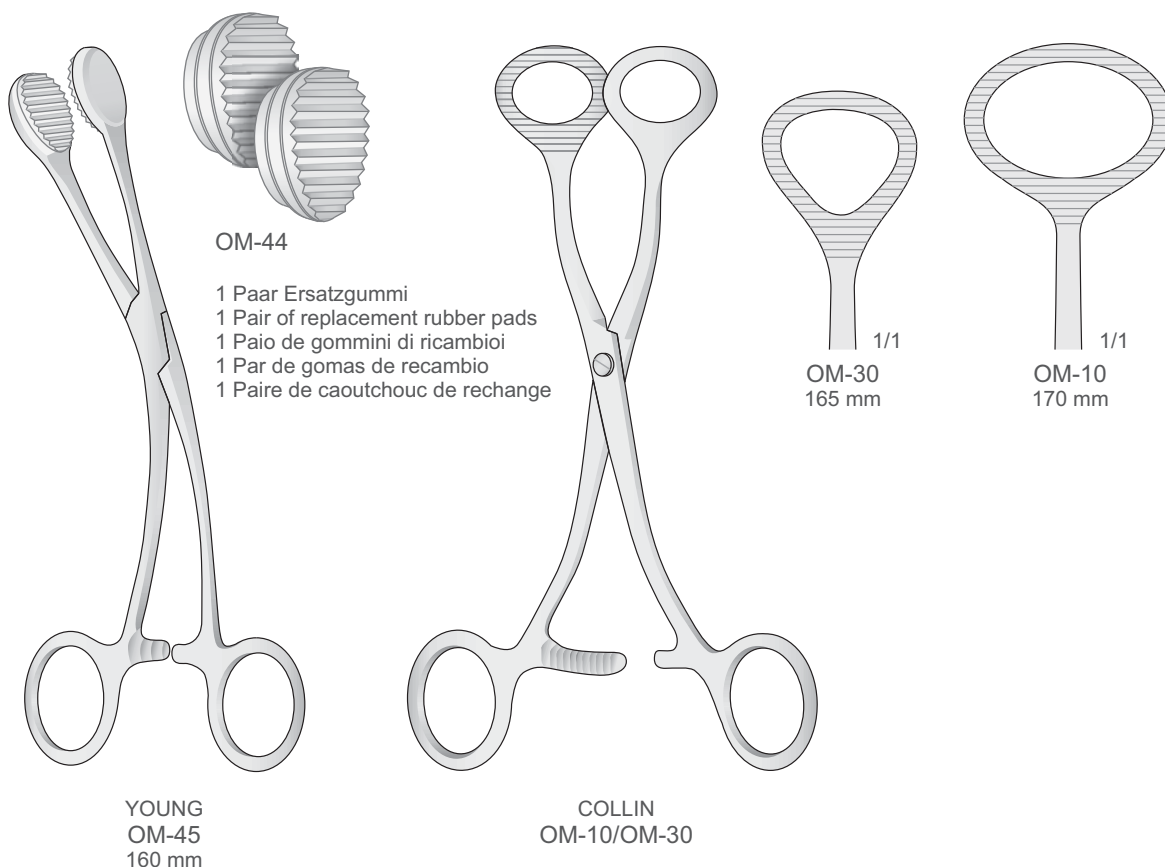
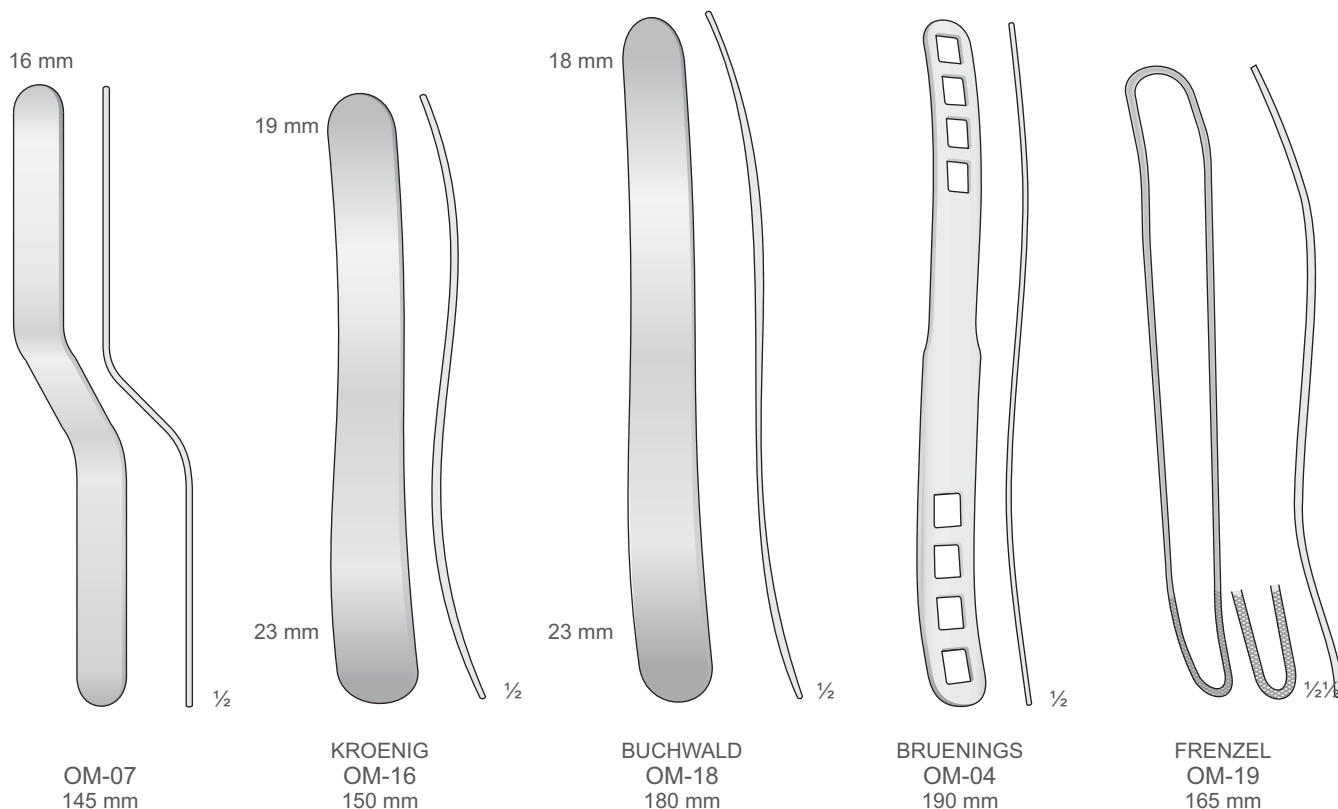



09 |

Implantology
Implantologie
Implantologie
Implantología
Implantologia



Osteotome
Osteotomes
Osteotomi
Osteótomos
Ostéotomes

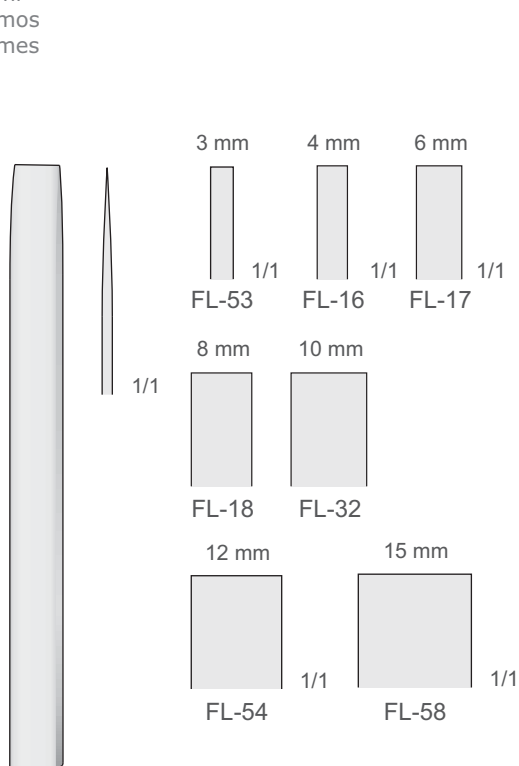

MINI-LAMBOTTE
FL-16/FL-58
125 mm

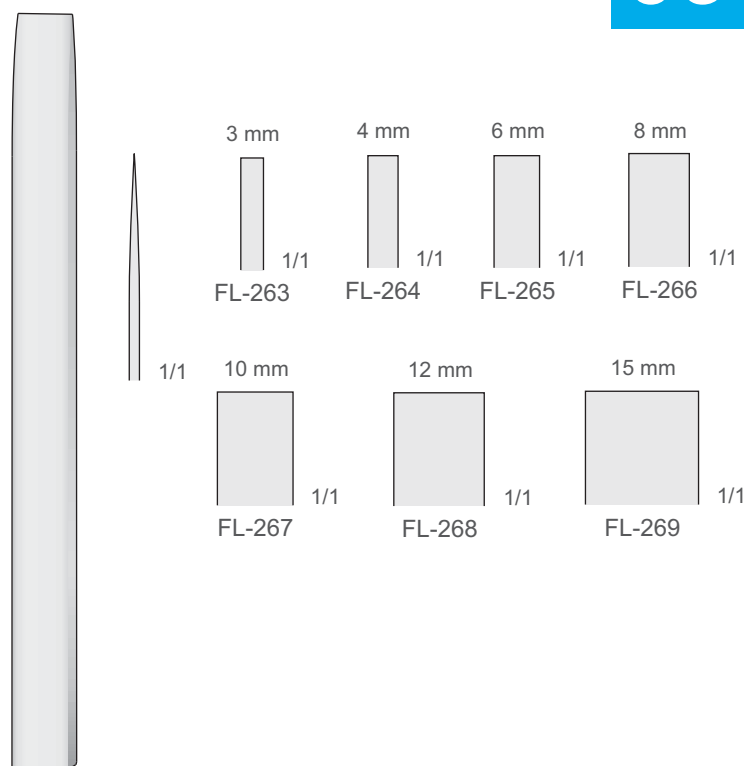

MINI-LAMBOTTE
FL-263/FL-269
170 mm

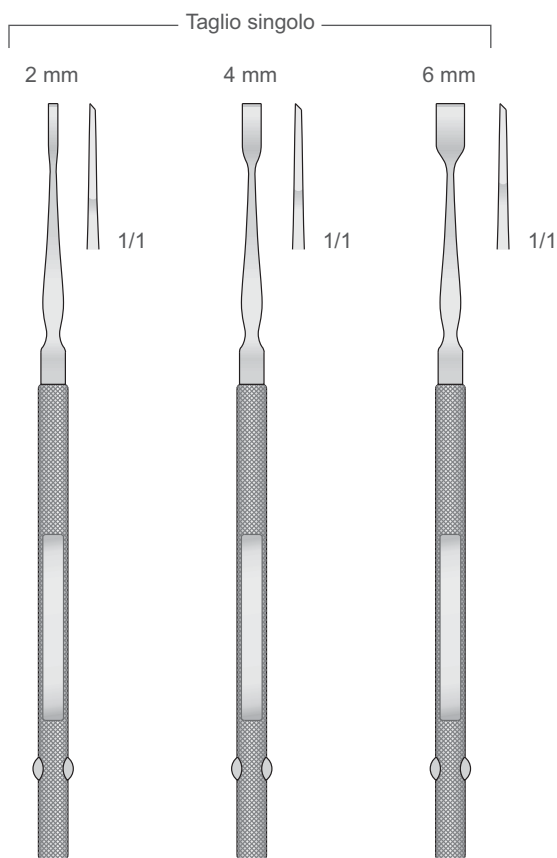

FREER
TG-10
160 mm

FREER
TG-11
160 mm

FREER
TG-12
160 mm

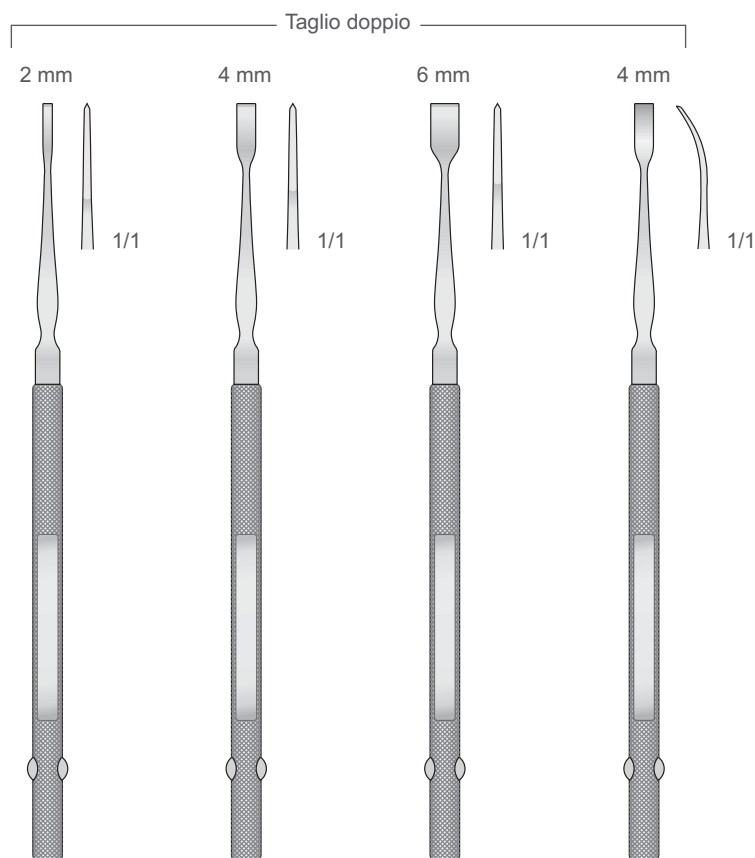

FREER
TG-20
160 mm

FREER
TG-21
160 mm

FREER
TG-22
160 mm

FREER
TG-23
160 mm

Osteotome - Meißel
Osteotomes - Gouges
Osteotomi - Sgorbie
Osteótomos - Gubias
Ostéotomes - Gouges

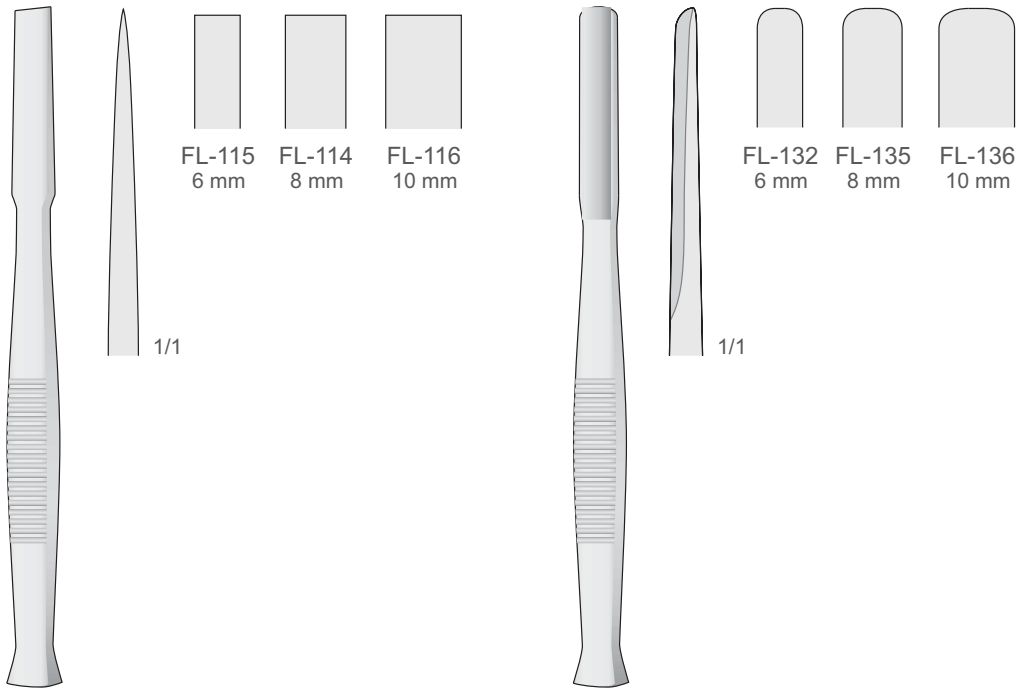

FL-114/FL-116
140 mm

FL-132/FL-136
140 mm

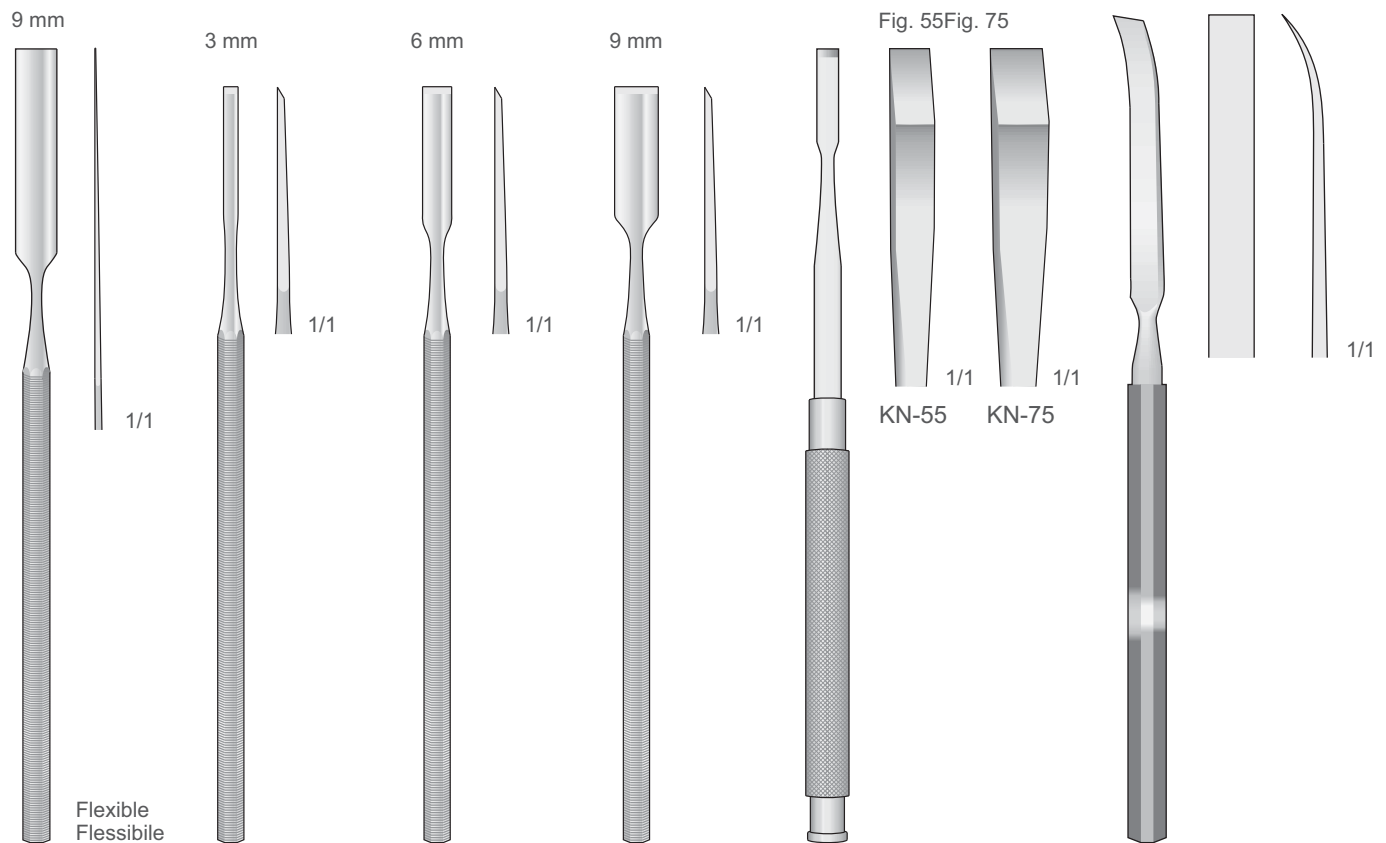

TG-15
170 mm

TG-30
155 mm

TG-31
155 mm

TG-32
155 mm

KRAMER-NEVINS
KN-55/KN-75
175 mm

DO-196
180 mm



Osteotome - Hohlmeissel
Osteotomes - Gouges
Osteotomi - Scalpelli
Osteótomos - Cinceles
Ostéotomes - Scalpel

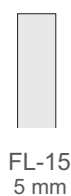
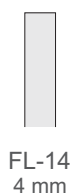
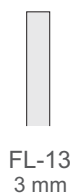
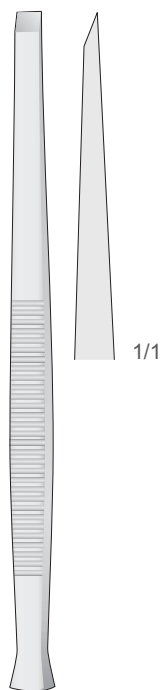

PARTSCH
FL-13/FL-15
140 mm

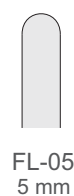
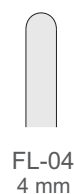
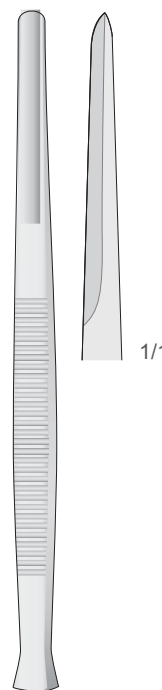

PARTSCH
FL-03/FL-05
140 mm

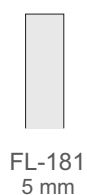
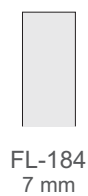
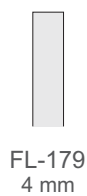
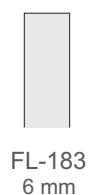
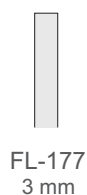
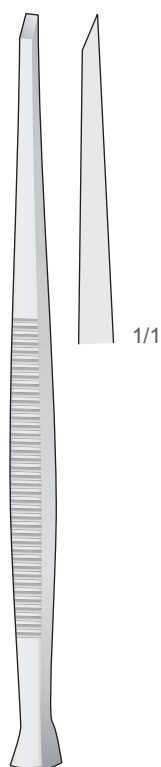

PARTSCH
FL-177/FL-184
170 mm

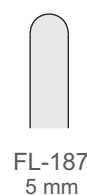
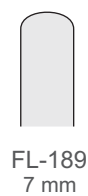
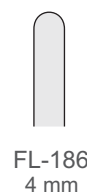
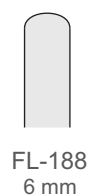
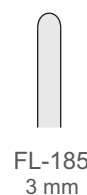
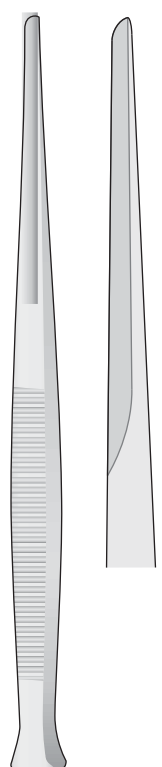

PARTSCH
FL-185/FL-189
170 mm

Osteotome - Meissel
Osteotomes - Chisels
Osteotomi - Scalpelli
Osteótomos - Cinceles
Ostéotomes - Burins

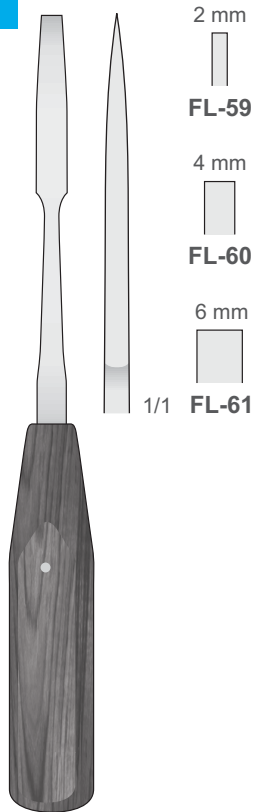

MINI-LEXER
FL-59/FL-61
200 mm

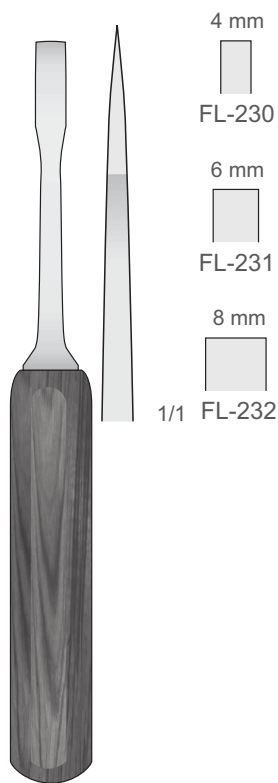

MINI-LEXER
FL-230/FL-232
180 mm

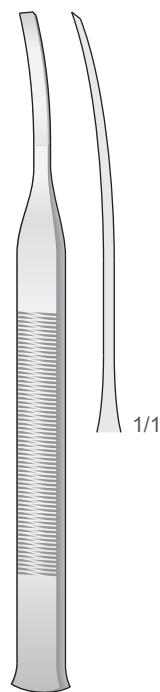

TESSIER
FL-411 5 mm
FL-412 7 mm
160 mm

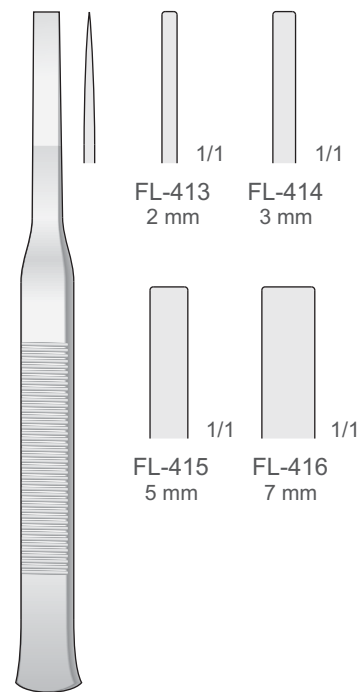

TESSIER
FL-413/FL-416
160 mm

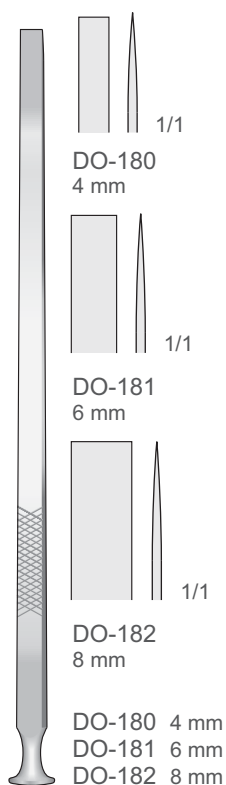

EPKER
DO-180/DO-182
180 mm

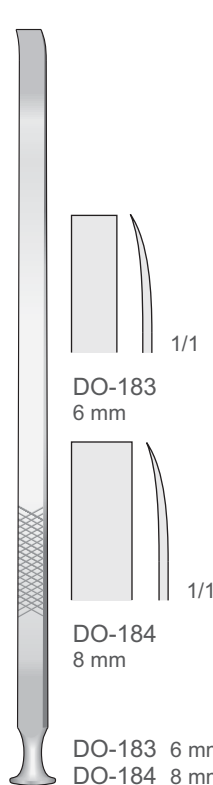

EPKER
DO-183/DO-184
180 mm

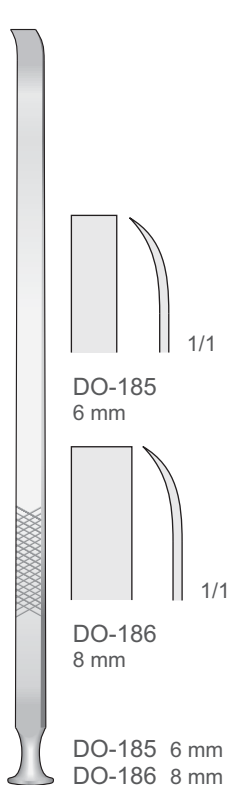

EPKER
DO-185/DO-186
180 mm

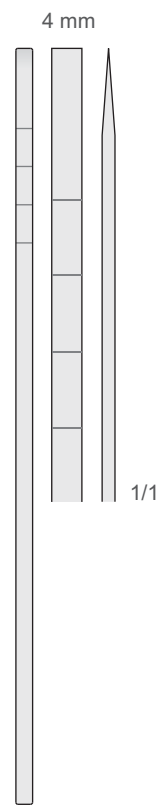

COTTLE
DO-140
180 mm

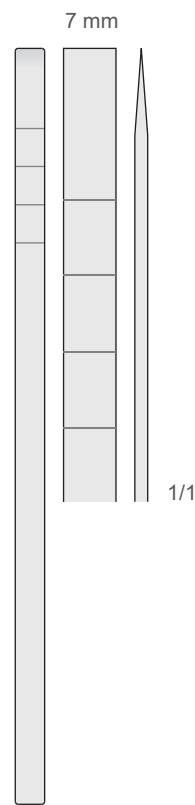

COTTLE
DO-141
180 mm

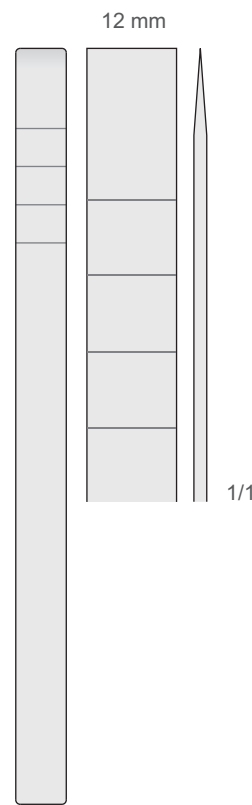

COTTLE
DO-143
180 mm



Chirurgische Hämmer
Surgical mallets
Martelli chirurgici
Martillos quirúrgicos
Maillets chirurgicaux

Ø 20 mm - 140 g



FL-01
165 mm

Ø 25 mm - 300 g

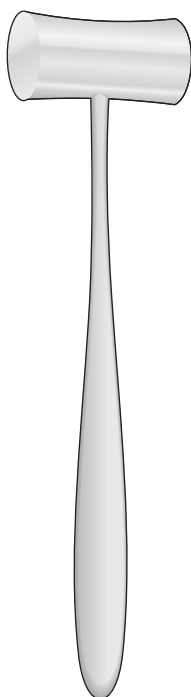

LUCAE
FL-10M
190 mm

Ø 27 mm - 135 g

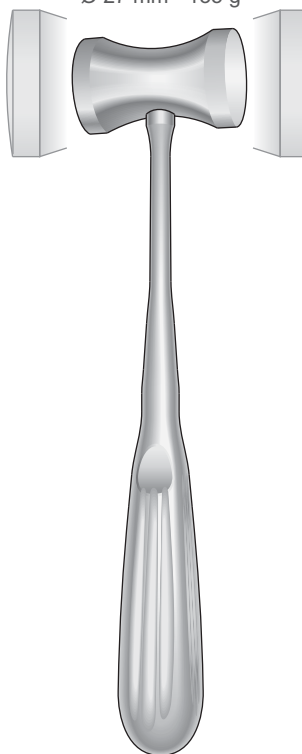

HAJEK
FL-128
200 mm

Ø 30 mm - 240 g

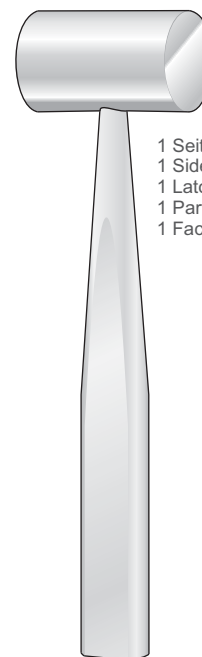

COTTLE
FL-104
185 mm

1 Seite flach - 1 Seite convex
1 Side flat - 1 Side convex
1 Lato piatto - 1 Lato convesso
1 Parte plana - 1 Parte convexe
1 Face plate - 1 Face convexe

Ø 20 mm - 160 g

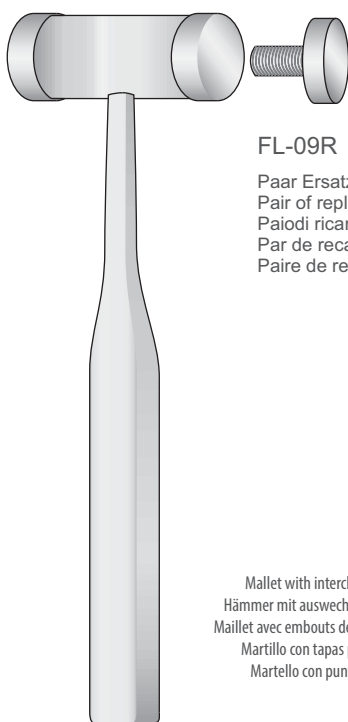

MEAD
FL-09
190 mm

FL-09R

Paar Ersatzbacken
Pair of replacement
Paiodi ricambio
Par de recambio
Paire de rechange

Mallet with interchangeable plastic disks
Hämmer mit auswechselbaren Kunststoffbacken
Maillet avec embouts de plastique interchangeable
Martillo con tapas plásticas reemplazables
Martello con punte di ricambi in teflon

Ø 25 mm - 200 g

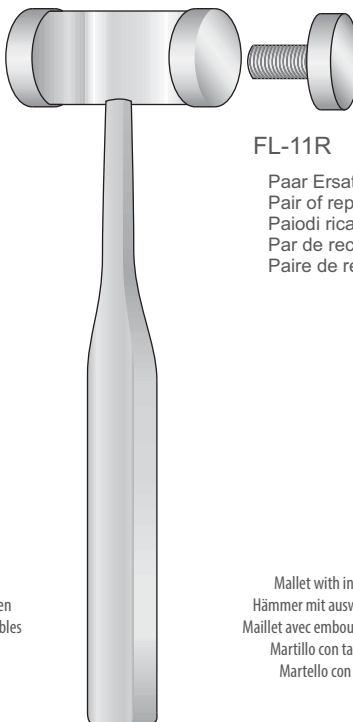

MEAD
FL-11
200 mm

FL-11R

Paar Ersatzbacken
Pair of replacement
Paiodi ricambio
Par de recambio
Paire de rechange

Mallet with interchangeable plastic disks
Hämmer mit auswechselbaren Kunststoffbacken
Maillet avec embouts de plastique interchangeable
Martillo con tapas plásticas reemplazables
Martello con punte di ricambi in teflon

Ø 26 mm - 320 g

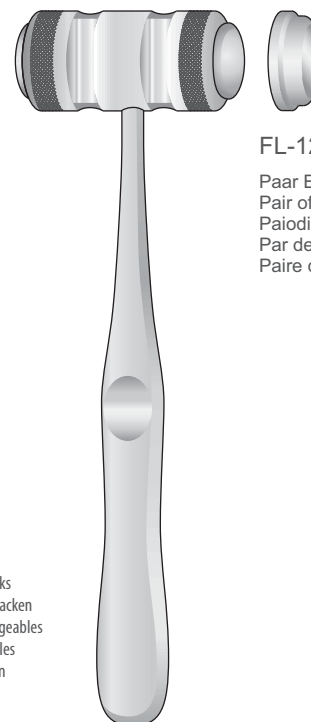

MEAD
FL-12
190 mm

FL-12R

Paar Ersatzbacken
Pair of replacement
Paiodi ricambio
Par de recambio
Paire de rechange

Sinus Lift Retraktoren - Sinus Lift Retractors
Divaricatori per Sinus Lift - Separadores para Sinus Lift
Écarteurs pour Sinus Lift

17 mm

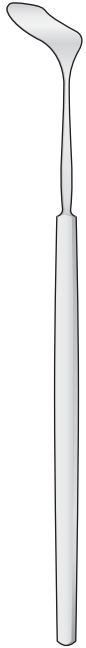

SAUTTER
NK-249
145 mm

11 mm

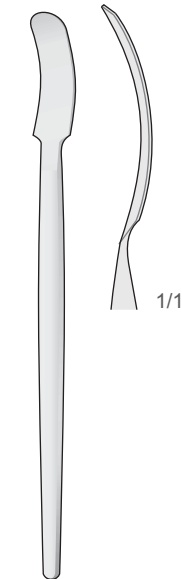

NK-105
125 mm

9 mm

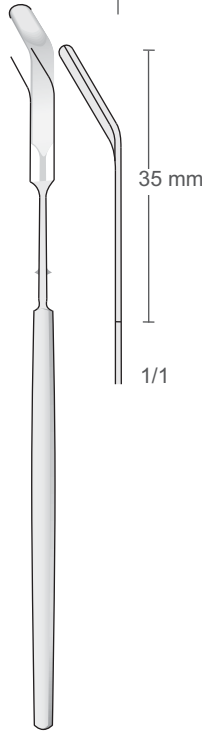

MODELL GIESSEN
NK-251
160 mm

35 mm

1/1



1/1

Dissektor
Dissector
Dissettore
Separatore
di tessuti
Separadores
Dissecteur

ES-13
135 mm

4.5 mm

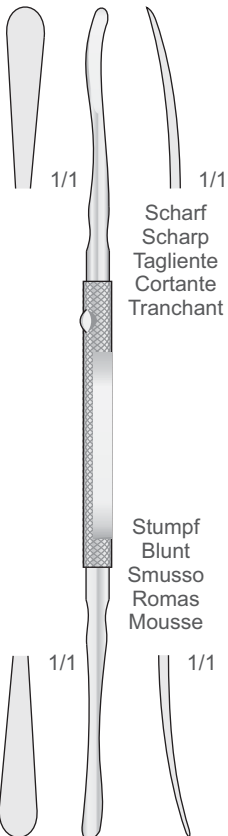

FREER
180 mm

Scharf
Sharp
Tagliente
Tranchant
Cortante

Stumpf
Blunt
Smusso
Romas
Mousse

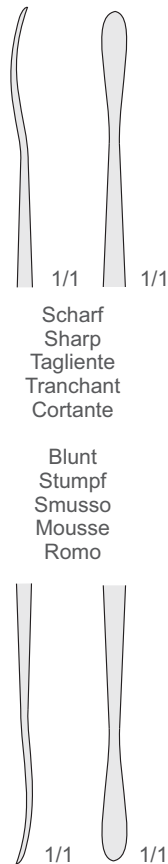

FREER
FR-16
185 mm

Scharf
Sharp
Tagliente
Tranchant
Cortante

Blunt
Stumpf
Smusso
Mousse
Romo

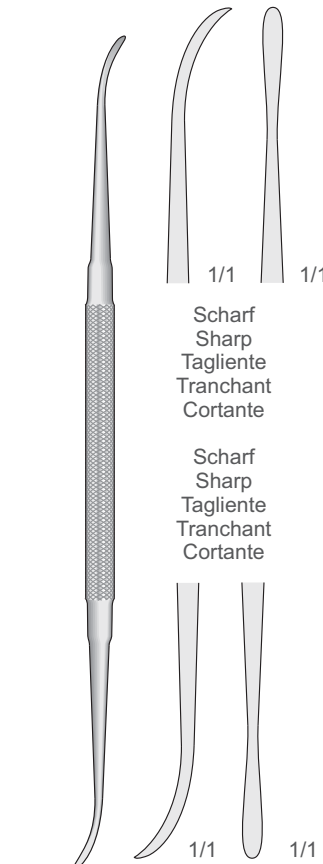

FREER-YASARGIL
FR-17
185 mm

Scharf
Sharp
Tagliente
Tranchant
Cortante

Scharf
Sharp
Tagliente
Tranchant
Cortante

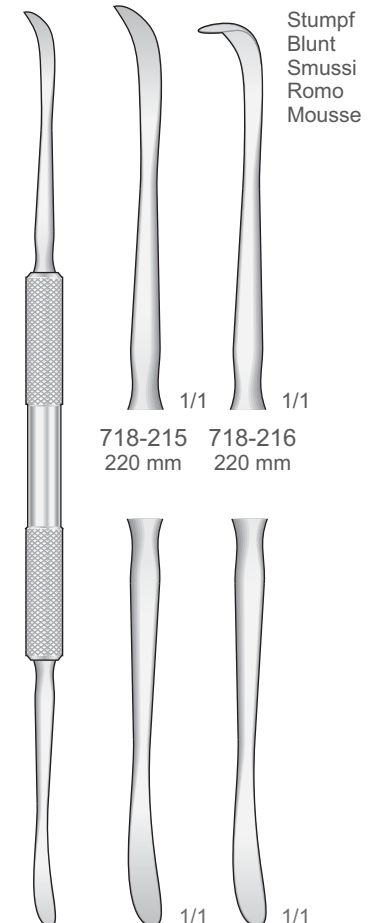

OBWEGESER-FREER
718-215/718-216
220 mm

718-215
220 mm

718-216
220 mm

Stumpf
Blunt
Smussi
Romo
Mousse



Trepanbohrer
Trepines
Trepine
Trépanos
Trépan

Combination Trocar-Trephine Instruments

Bestehend aus einem Trokar, einer gezahnten Trepine und einem Kolben zur Entnahme von Knochentransplantaten aus Tibia und Beckenkamm mittels eines geschlossenen Verfahrens

Consisting of trocar, a toothed trephine and a plunger for taking tibial and iliac bone grafts through a closed technique

Composto di un trequarti, una camicia dentata ed un pistone per il prelievo degli innesti ossei dalla tibia e dalla cresta iliaca tramite una tecnica chirurgica intracutanea

Compuesto por un trócar, un trépano dentado y un émbolo para obtener injertos óseos tibiales e iliacos mediante una técnica cerrada

Composé d'un trocart, d'une tréphine dentée et d'un piston pour le prélèvement de greffes osseuses de la tibia ou de la crête iliaque par une technique fermée

FK-100

Komplettsset mit 4 Teilen
Set complete with 4 pieces
Set completo di 4 pezzi
Set completo con 4 piezas
Set complet avec 4 pièces

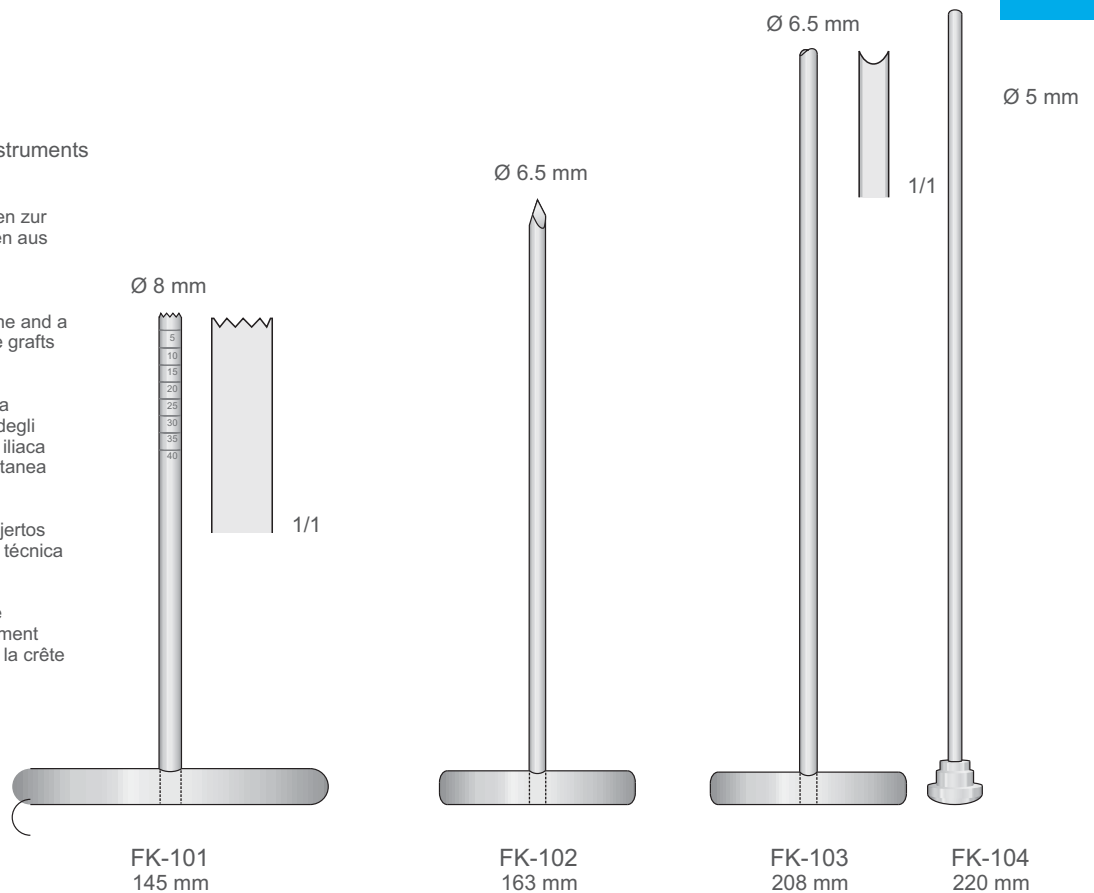

FK-101
145 mm

FK-102
163 mm

FK-103
208 mm

FK-104
220 mm

FK-105

Komplettsset mit 4 Teilen
Set complete with 4 pieces
Set completo di 4 pezzi
Set completo con 4 piezas
Set complet avec 4 pièces

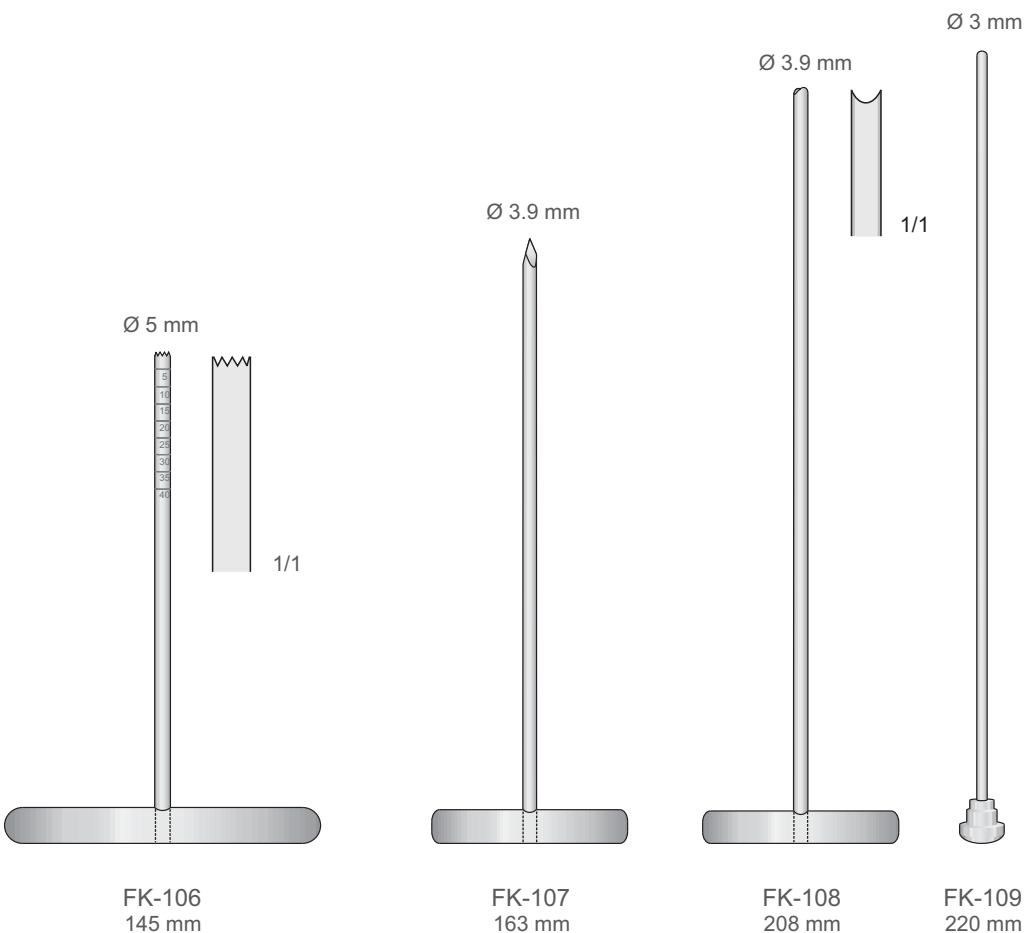

FK-106
145 mm

FK-107
163 mm

FK-108
208 mm

FK-109
220 mm

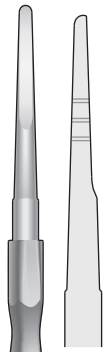

MIR-30
130 mm

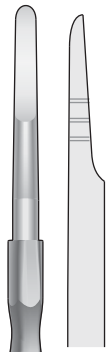

MIR-31
130 mm

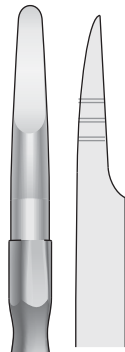

MIR-32
130 mm

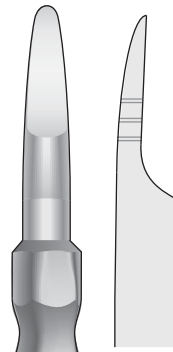

MIR-33
130 mm

BONE EXPANDERS
Distraktoren für Knochenleiste
Distracteurs de crête osseuse
Expansores de cresta ósea
Distrattori per cresta ossea

TUNNELING INSTRUMENTS

Tunnelierinstrumente | Instruments pour tunnellation | Instrumentos para tunelización | Strumenti per tunneling

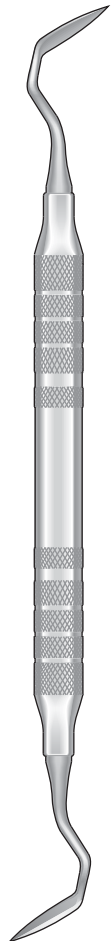

UST-1/2ML

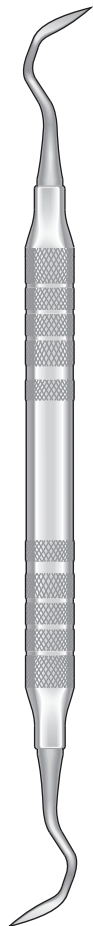

UST-1/2MS

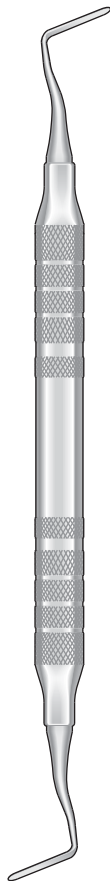

UST-KPA

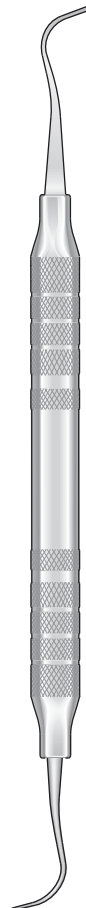

USS-YG7/8



UST-MP



UST-MPA



Osteotome
Osteotomes
Osteotomi
Osteótomos
Ostéotomes

FL-400
IMPLANT SINUS LIFT OSTEOTOMES SET
FL-391 + FL-392 + FL-393 + FL-394 + FL-395 + FL-396 + FL-397 + FL-398 + FL-399
(1 + 2 + 3 + 4 + 5 + 6 + 7 + 8 + 9)
+ BS-60 (Stainless Steel Container)

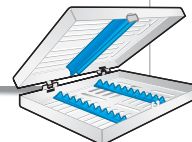

FL-400M
COMPLETE IMPLANT SINUS LIFT OSTEOTOMES SET
FL-389 + FL-390 + FL-391 + FL-392 + FL-393 + FL-394 + FL-395 + FL-396 + FL-397 + FL-398 + FL-399
(00 + 0 + 1 + 2 + 3 + 4 + 5 + 6 + 7 + 8 + 9)
+ BS-60 (Stainless Steel Container)

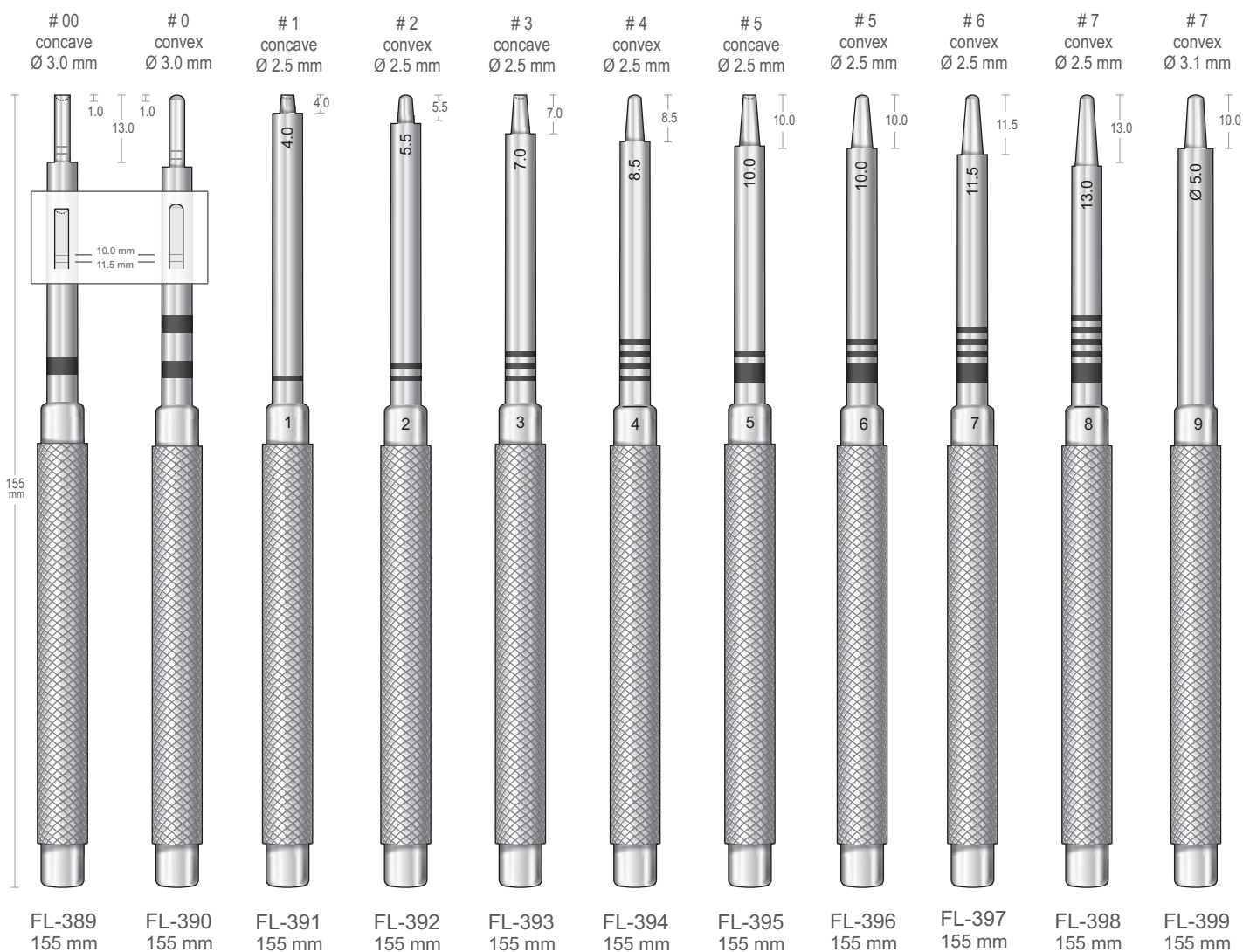
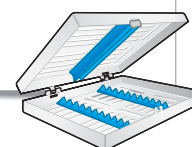

# 1	Diam.
0	Ø 1.60
7.5	Ø 1.80
10	Ø 2.00
13.5	Ø 2.40
15.5	Ø 3.60

# 2	Diam.
0	Ø 1.90
7.5	Ø 2.20
10	Ø 2.35
13.5	Ø 3.30
15.5	Ø 3.40
23.5	Ø 4.50

# 3	Diam.
0	Ø 2.80
7.5	Ø 3.20
10.5	Ø 3.35
13.5	Ø 3.60
21	Ø 4.40

# 4	Diam.
0	Ø 3.10
7.5	Ø 3.70
10.5	Ø 3.90
15.5	Ø 4.30

# 5	Diam.
0	Ø 3.90
10	Ø 5.00
13	Ø 5.20
20.5	Ø 6.30

# 6	Diam.
0	Ø 5.50
10	Ø 6.20
13	Ø 6.30

1
Ø 1.6 mm



FL-120
155 mm

2
Ø 1.9 mm



FL-121
155 mm

3
Ø 2.8 mm



FL-122
155 mm

4
Ø 3.10 mm



FL-123
155 mm

5
Ø 3.90 mm



FL-124
155 mm

6
Ø 5.50 mm



FL-125
155 mm



Osteotome
Osteotomes
Osteotomi
Osteótomos
Ostéotomes

# 1 Diam.	# 2 Diam.	# 3 Diam.	# 4 Diam.	# 5 Diam.
0 Ø 1.50	0 Ø 2.10	0 Ø 2.60	0 Ø 3.00	0 Ø 3.50
5 Ø 1.90	5 Ø 2.60	5 Ø 3.00	5 Ø 3.50	5 Ø 3.90
8 Ø 2.20	8 Ø 2.80	8 Ø 3.30	8 Ø 3.80	8 Ø 4.20
10 Ø 2.40	10 Ø 3.00	10 Ø 3.50	10 Ø 4.00	10 Ø 4.40
12 Ø 2.60	12 Ø 3.20	12 Ø 3.70	12 Ø 4.20	12 Ø 4.60
14 Ø 2.80	14 Ø 3.40	14 Ø 3.90	14 Ø 4.40	14 Ø 4.80

Straight
Gerade
Droit
Recto
Diritto

Bone Pusher

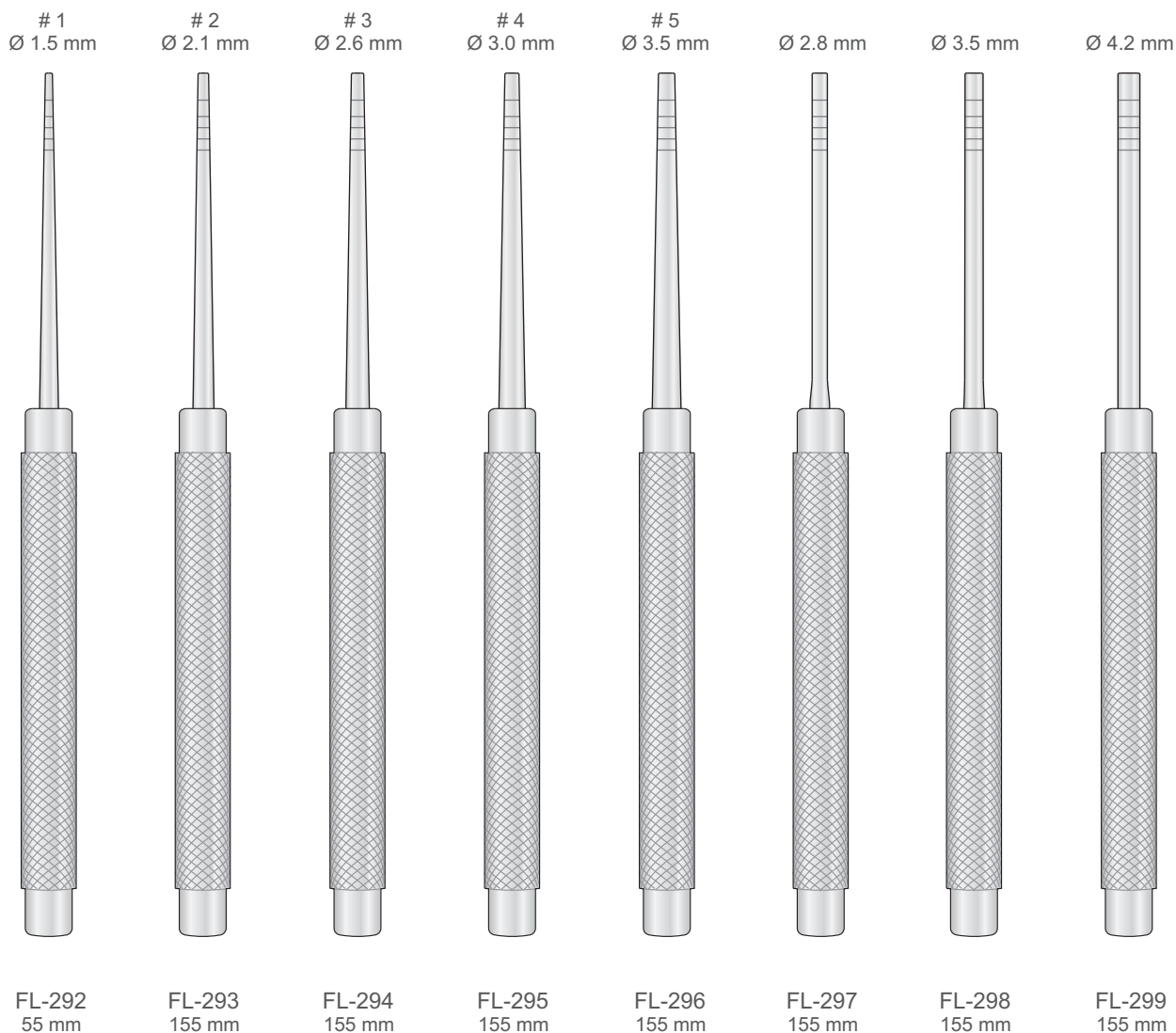

Meißeln Graduiert
Graduated Chisels
Scalpelli graduati
Cinceles graduados
Burins gradués

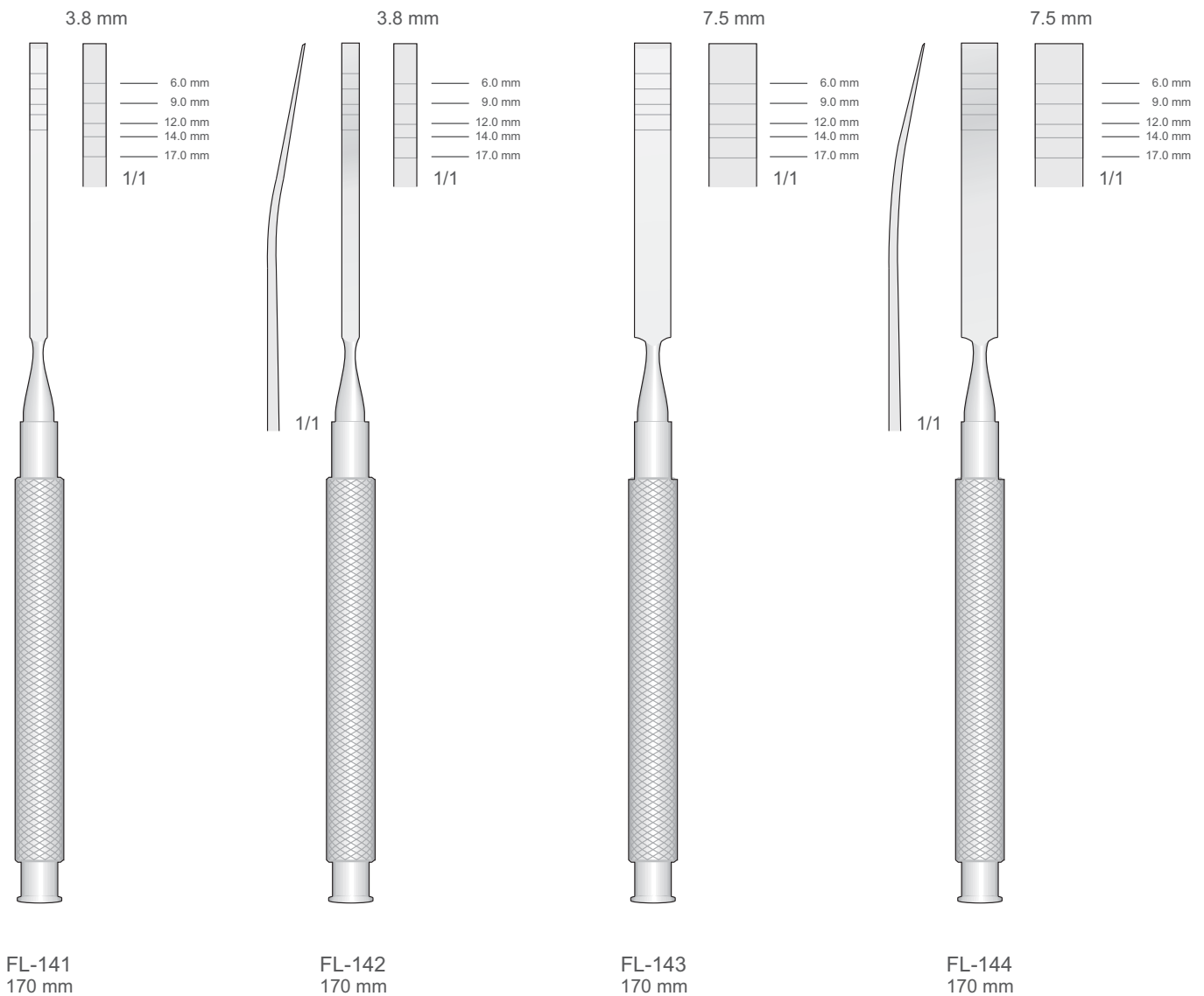



Osteotome
Osteotomes
Osteotomi
Osteótomos
Ostéotomes

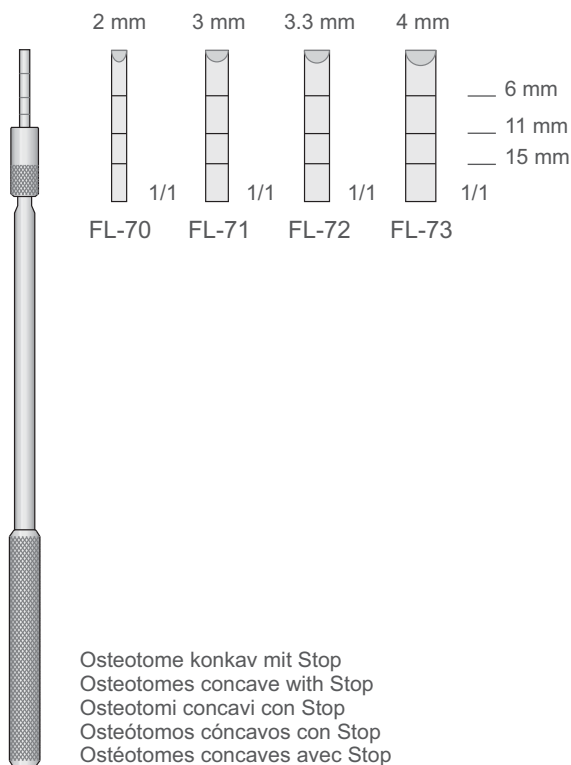

FL-70/FL-73
165 mm

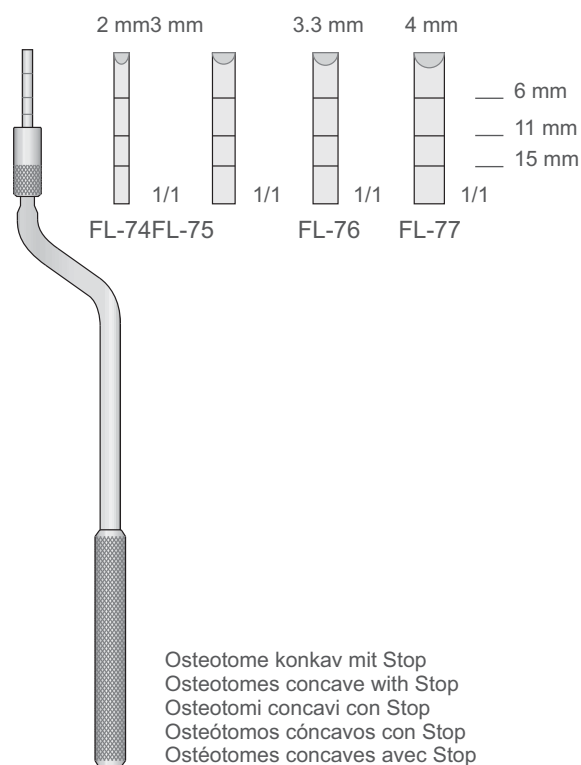

FL-74/FL-77
165 mm

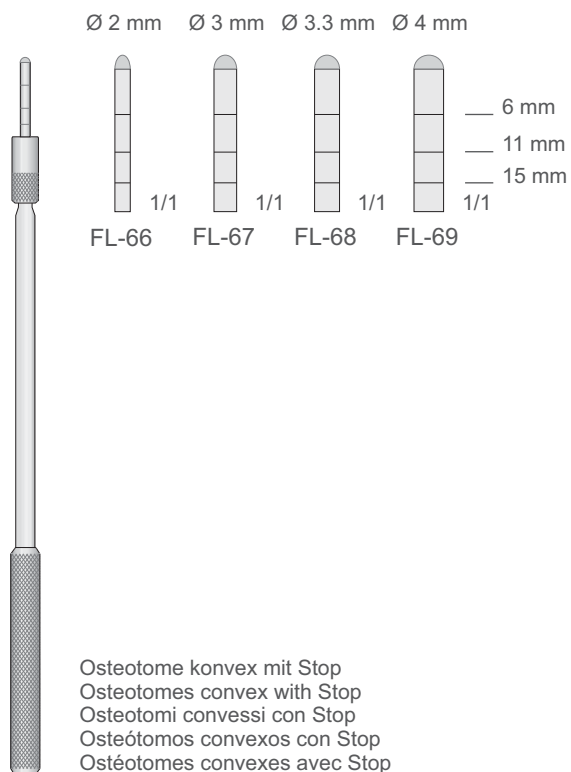

FL-66/FL-69
165 mm

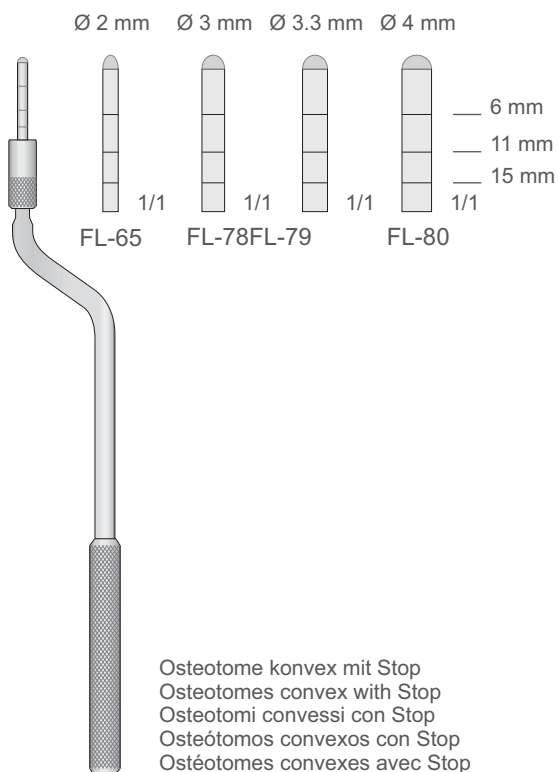

FL-65/FL-80
160 mm

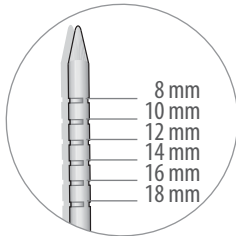

Dilatator
Dilator
Dilatatori
Dilatador
Dilatateur

A-Form

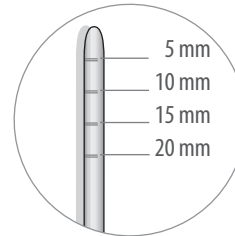

Spreader
Spreader
Expansori
Expansor
Expandeur

D-Form
Convex Tip

Ø 2 mm



FL-25
145 mm

Ø 3 mm



FL-26
145 mm

Ø 3.3 mm



FL-27
145 mm

Ø 4 mm



FL-28
145 mm

Ø 3 mm



FL-37
145 mm

Ø 4 mm



FL-38
145 mm

Ø 5 mm



FL-39
145 mm



Trepanbohrer
Trepines
Trepine
Trépanos
Trépan

<p>For Tissue Für Gewebe Pour tissu Para tejido Per tessuto</p>	<p>Nicht Gezahnt Non Serrated No dentellato No dentado Non dentelé</p>	<p>For Bone Für Knochen Pour os Para hueso Per osso</p>	<p>Gezahnt Serrated Dentellato Dentado Dentelé</p>
---------------------------------------------------------------------------------	----------------------------------------------------------------------------------------	-------------------------------------------------------------------------	--------------------------------------------------------------------

Ø mm	GA-63	GA-64	GA-65	GA-66
Int.	2.5	4.0	4.5	5.5
Ext.	3.0	4.5	5.0	6.0

Ø mm	GA-33	GA-34	GA-35	GA-36	GA-37
Int.	2.5	4.0	4.5	5.5	6.5
Ext.	3.0	4.5	5.0	6.0	7.0

Hautstanzen
Tissue Punches
Mucotomi Punches
Bisturi circular para tejido
Bistouri circulaire pour tissue

KEYES
FL-150/FL-153
100 mm

KEYES
FL-155/FL-159
90 mm

Implant Graduierung
Implant depth gauge with ball end
Sonda per controllare la profondità del sito
Sonda para controlar la profundidad

GA-60
100 mm

Knochenschale
Bone Well
Bacinella per osso
Cubeta para hueso
Cuvette à os



Rostfrei
Stainless Steel
Acciaio inossidabile
Acero inoxidable
Acier Inoxydable

SS-65
35 mm

Absaugkanülen für Knochen. mit Filter
Suction tube for bone. with filter
Cannule d'aspiration con trattenuta osso. con filtro
Cánulas aspiradoras para hueso. con filtro
Canule d'aspiration pour os avec filtre

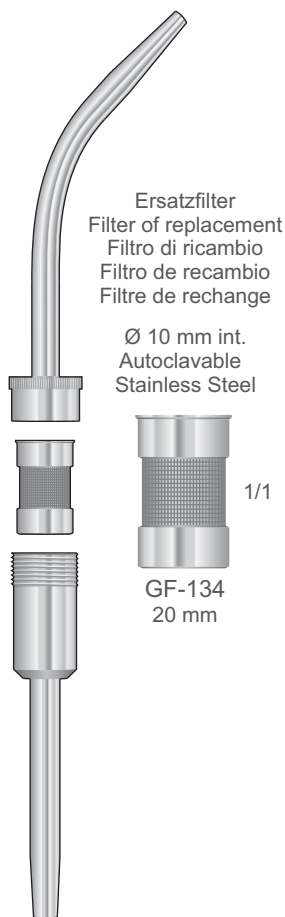

Ersatzfilter
Filter of replacement
Filtro di ricambio
Filtro de recambio
Filtre de rechange

Ø 10 mm int.
Autoclavable
Stainless Steel

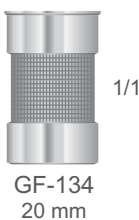

1/1

GF-133
180 mm

Membranplatzierungsinstrumente
Membrane Placement Instruments
Strumenti per posizionare membrana
Instrumentos para colocar membranas
Instruments pour application de membrane

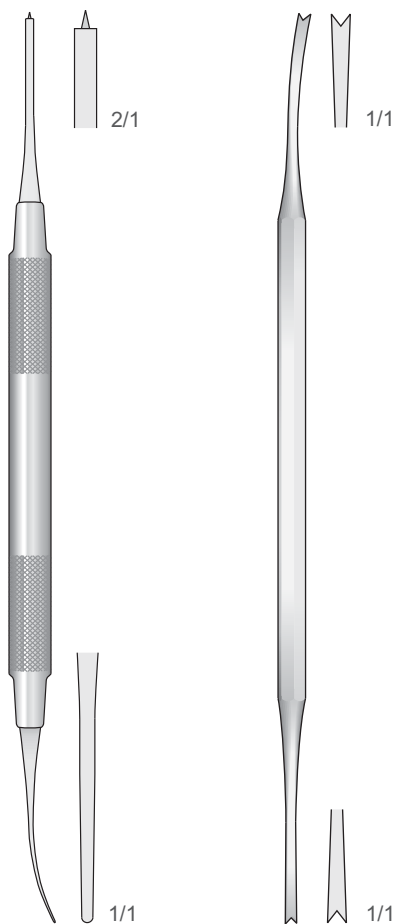

MPI-1
185 mm

LUNIATSCHEK
PF-6
170 mm

Aufbring Instrument für Knochenmaterial
Applicator for bone material
Aplicatore per materiale osseo
Cucharillas para material osseo
Applicateur pour matière osseuse

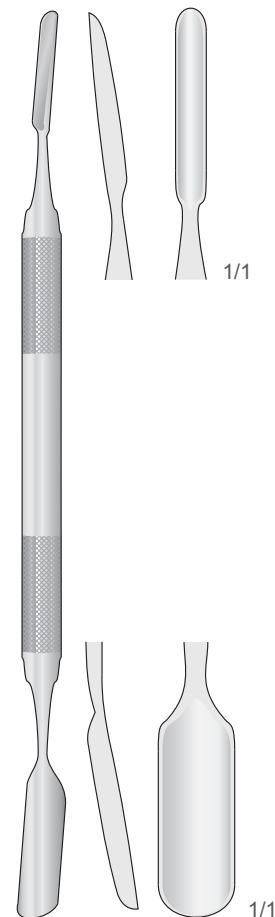

IM-15
180 mm



Knochenmühlen - und spritzen
Bone Mills and Syringes
Macina e siringhe per osso
Molinos y jeringas para hueso
Moulins et seringues à os



GA-18
Lower
Titanium



GA-17
Upper
Titanium



GA-19
Handle
with screw

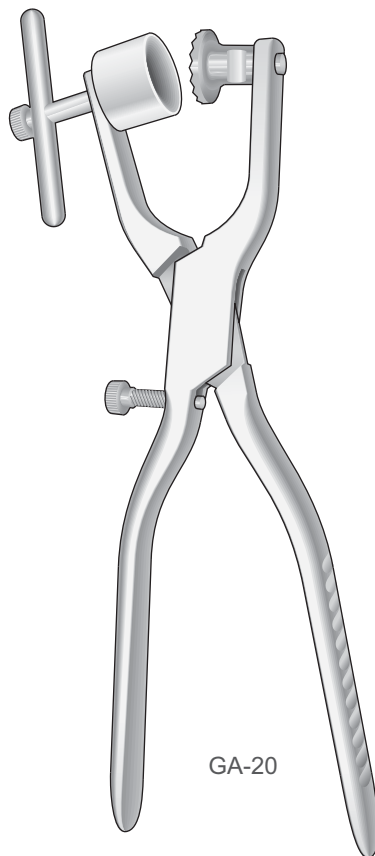

GA-20

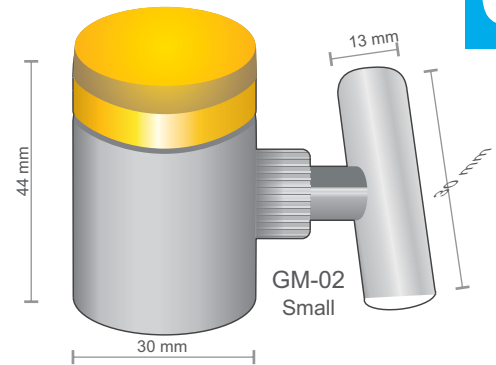

GM-02
Small

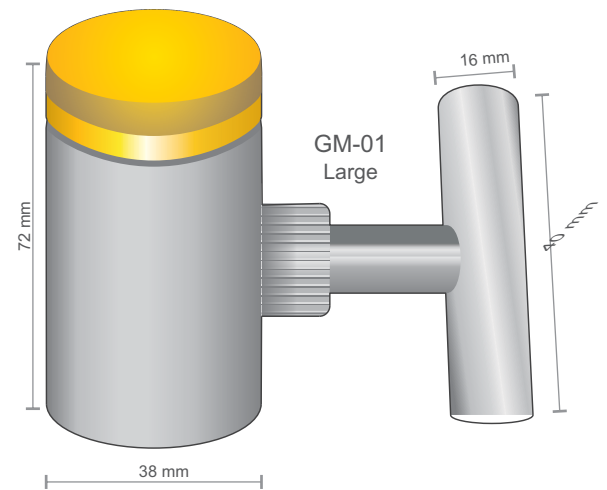

GM-01
Large

Ø int. 2.5 mm
Ø ext. 3.5 mm

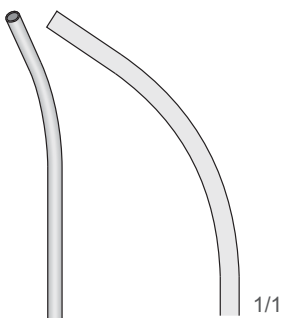

SS-60M
160 mm

Ø int. 3.5 mm
Ø ext. 4.5 mm

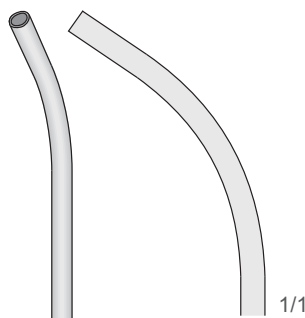

SS-61M
160 mm

Ø int. 4.4 mm
Ø ext. 5.5 mm

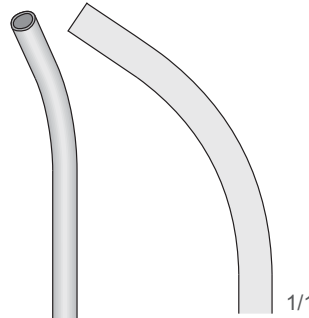

SS-62M
160 mm

Ø int. 6 mm
Ø ext. 7 mm

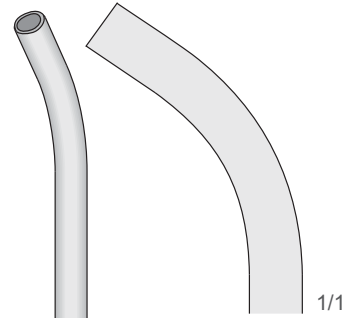

SS-64M
160 mm

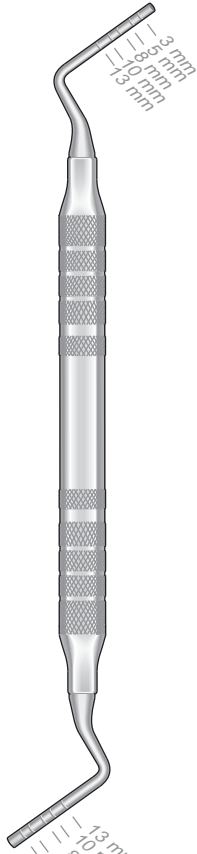

Non Serrated Tips				Serrated Tips			
USB-P1	○	Ø 1.8	○	Ø 2.8	USB-P1Z	●	Ø 1.8 Ø 2.8
USB-P2	○	Ø 3.2	○	Ø 3.8	USB-P2Z	●	Ø 3.2 Ø 3.8
USB-P3	○	Ø 4.2	○	Ø 4.8	USB-P3Z	●	Ø 4.2 Ø 4.8
USB-P4	○	Ø 5.0	○	Ø 5.5	USB-P4Z	●	Ø 5.0 Ø 5.5

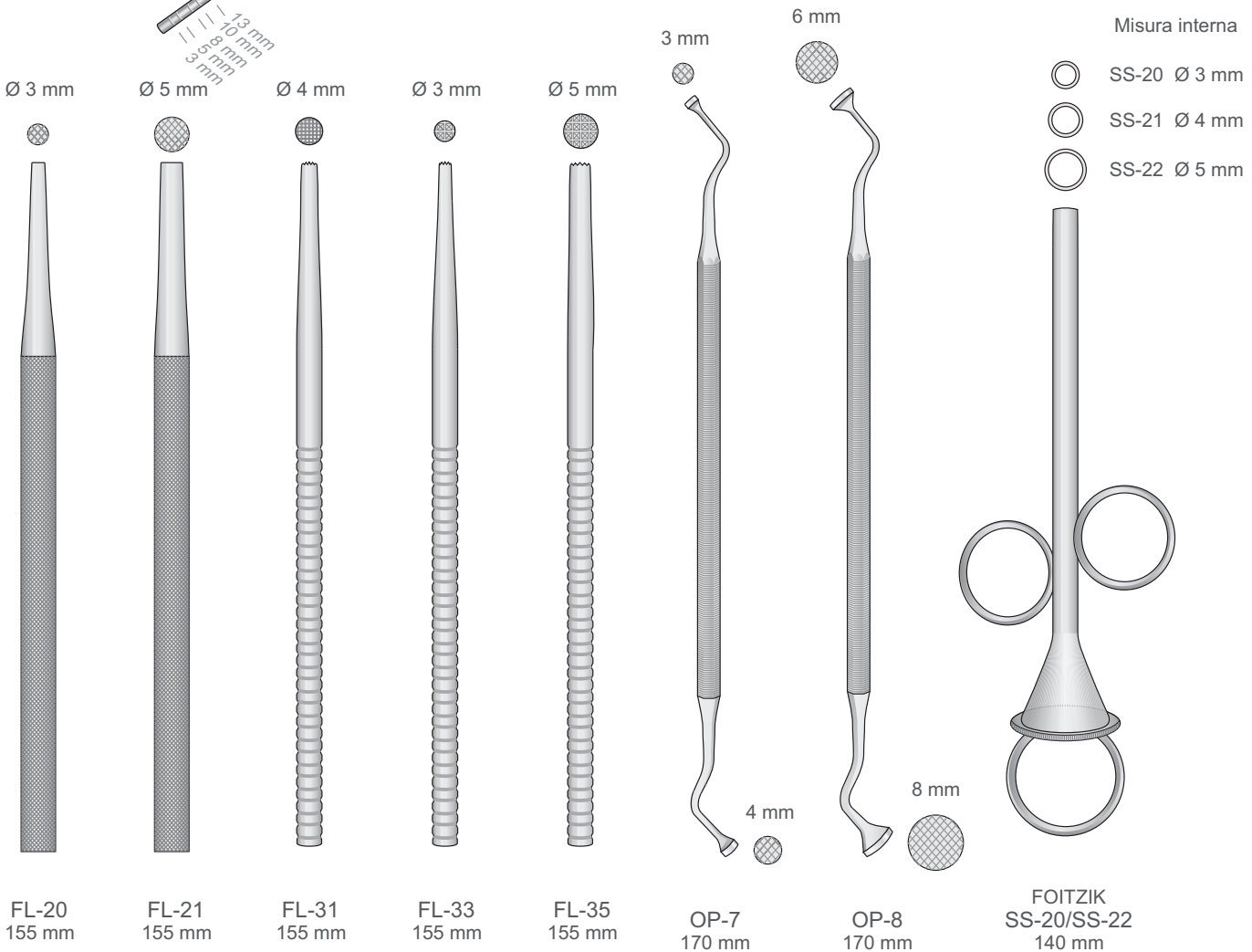



Knochenschaber. Rostfrei Stahl
Bone-Grafter. Stainless Steel
Grattini per osso. Inox
Raspador de hueso. Acero inoxidable
Racleur d'os. Acier inoxydable

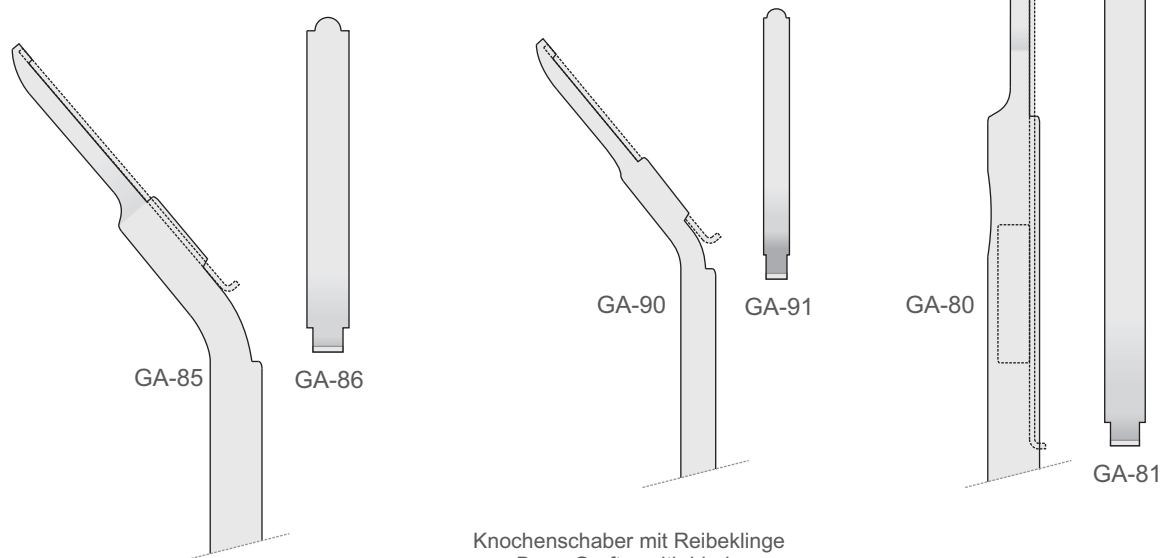

Knochenschaber mit Reibeklinge
Bone-Grafter with blade
Grattino con lama
Raspador de hueso con hoja
Racleur d'os avec lame

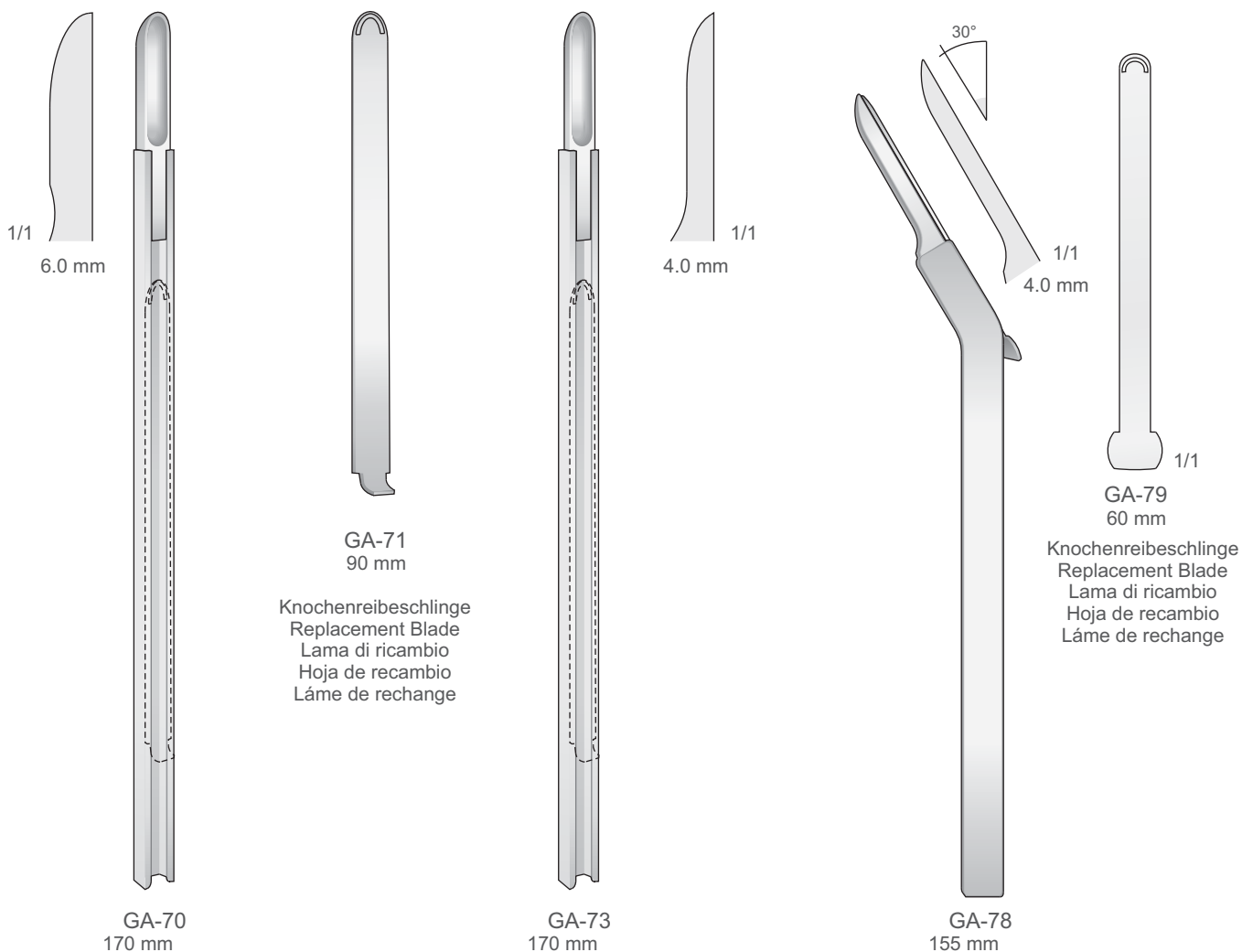

Meßbereich: 0 - 20 mm
Measuring range: 0 - 20 mm
Campo di misura: 0 - 20 mm
Alcance de medición: 0 - 20 mm
Etendue de mesure: 0 - 20 mm

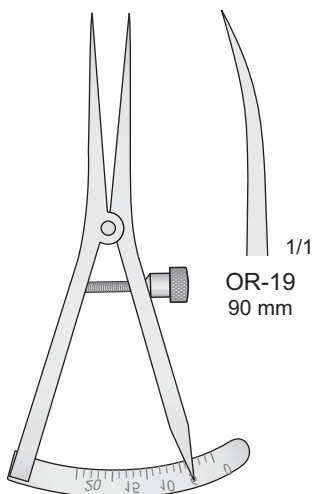

OR-19
CASTROVIEJO
90 mm

Meßbereich: 0 - 80 mm
Measuring range: 0 - 80 mm
Campo di misura: 0 - 80 mm
Alcance de medición: 0 - 80 mm
Etendue de mesure: 0 - 80 mm

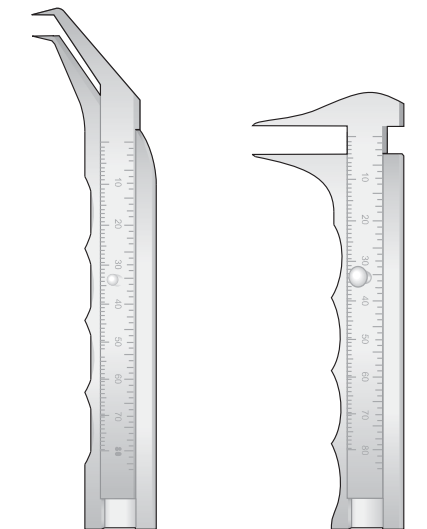

OR-40
125 mm

OR-45
95 mm

0 - 40 mm
Meßbereich / Measuring range / Campo di misura
Alcance de medición / Etendue de mesure

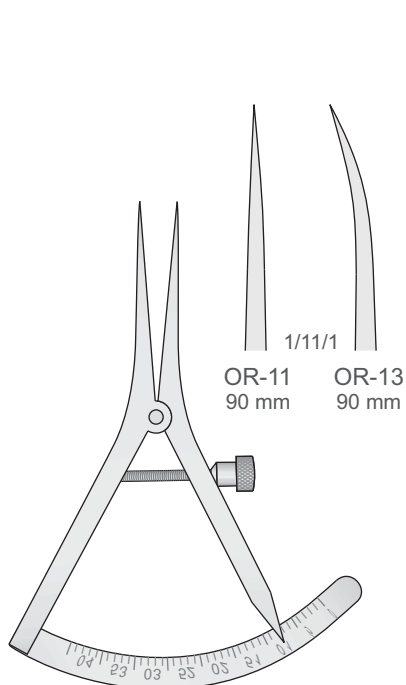

CASTROVIEJO
OR-11/OR-13
90 mm

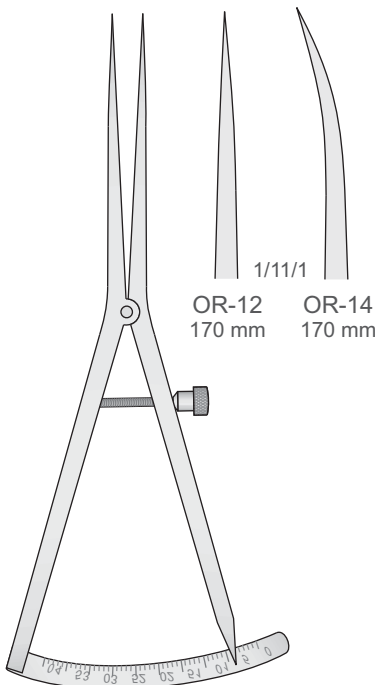

CASTROVIEJO
OR-12/OR-14
170 mm

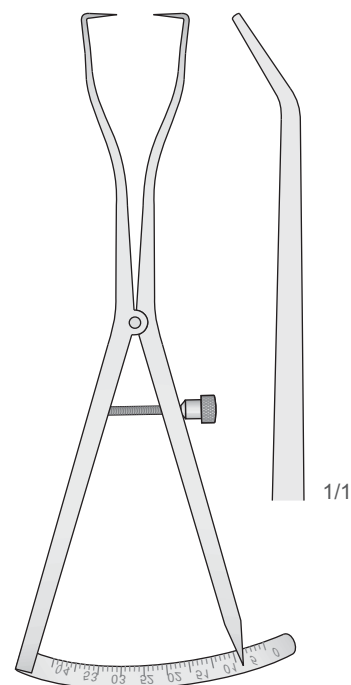

CASTROVIEJO
OR-18
170 mm



Osteometer
Osteometer
Osteometro
Osteometro
Osteometro
Osteometer

TRIDIMENSIONAL IMPLANTOLOGY CALIPER

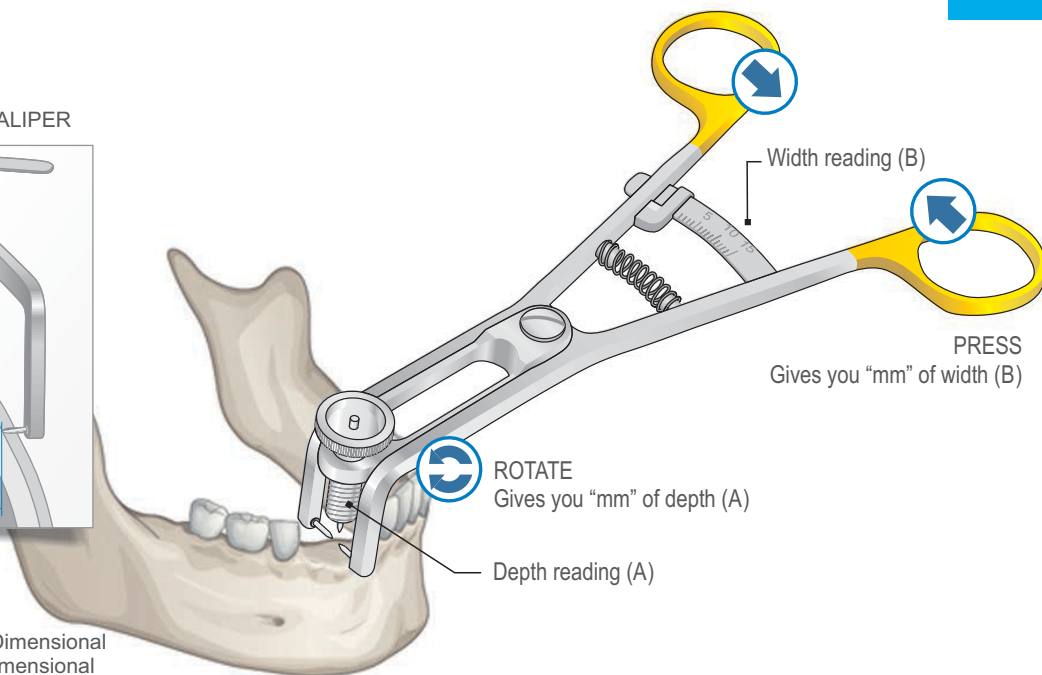
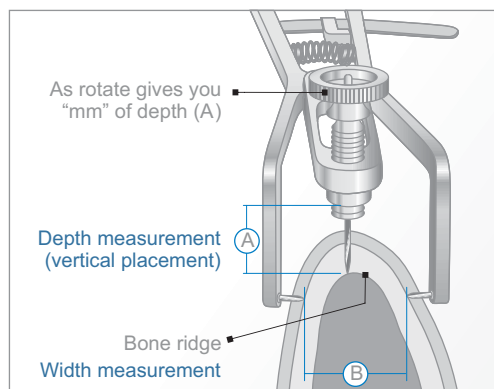

DB-300

Schieblehre für Implantologie
Implantology Calliper
Calibro per Implantologie
Calibre para Implantologia
Calibre pour Implantologie

Trei-Dimensional
Tridimensional
Tridimensionale
Tridimensional
Tridimensionnel

BONE BLOCK CLAMP
Bone Holding Clamps
Knochenhalteklammern
Daviers à os
Pinzas de sujeción para hueso
Pinze per fissare l'osso

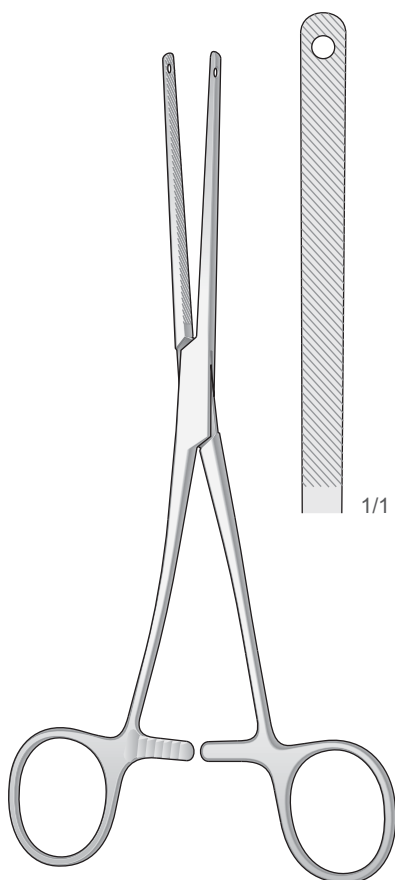

P-340
220 mm

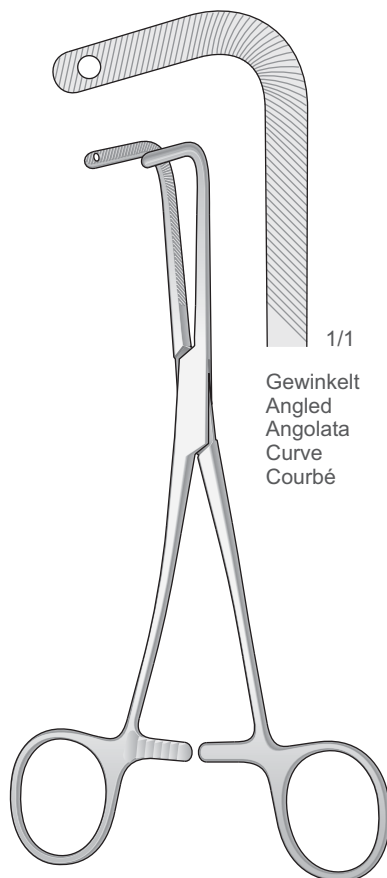

P-341
200 mm

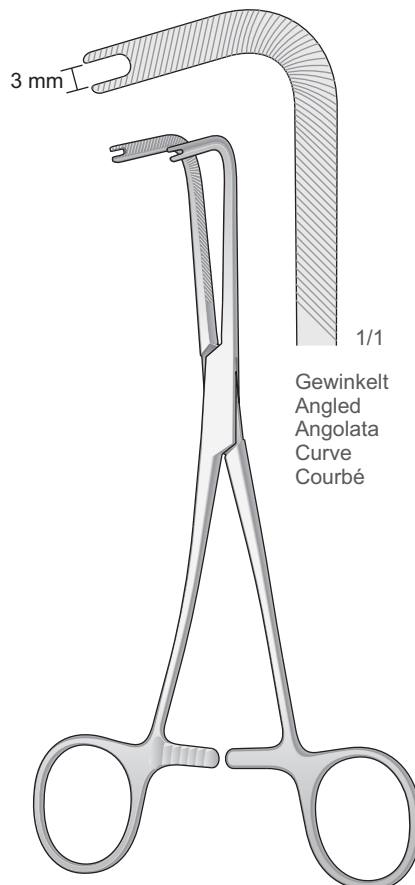

P-342
200 mm

Retraktoren - Knochenhaltezeuge
Retractors - Bone Holding Forceps
Divaricatori - Pinza per fissare l'osso
Separadores - Pinzas para sujeción para hueso
Écarteurs - Daviers à os

Tibia Wundspreizer
Tibial and Iliac Retractor
Divaricatore per tibia e cresta iliaca
Separadores tibiales e iliacos
Écarteur pour tibia e crête iliaque

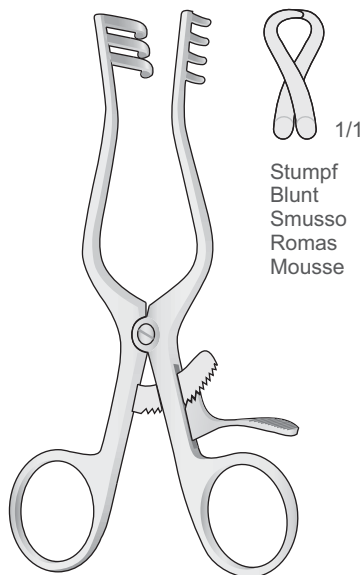

WEITLANER
BV-23
165 mm

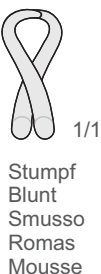

Stumpf
Blunt
Smusso
Romas
Mousse

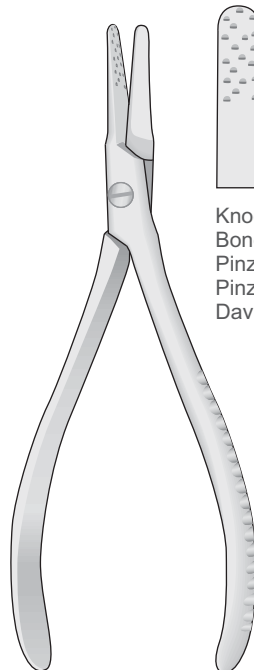

RADOLF
FO-159
135 mm

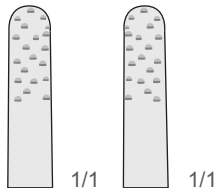

Knochenhaltezeuge
Bone Holding Forceps
Pinza per fissare l'osso
Pinzas de sujeción para hueso
Daviers à os

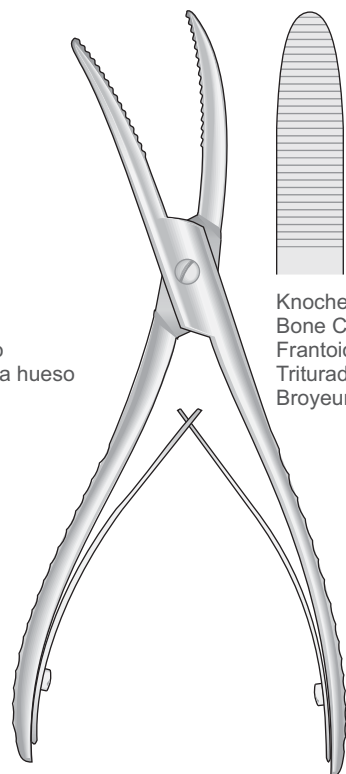

WOLFF
LX-113
180 mm

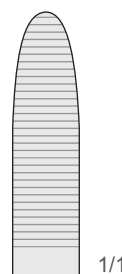

Knochen-Quetsche
Bone Crusher
Frantoio per osso
Triturador óseo
Broyeur d'os

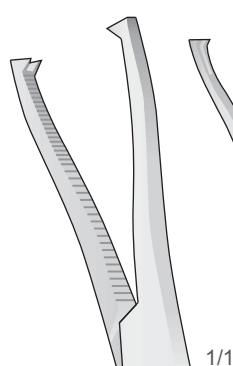

DINGMANN
FO-130

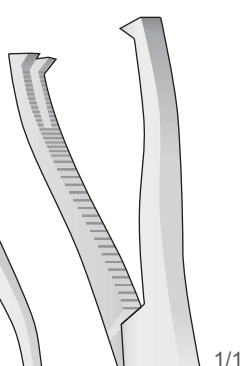

DINGMANN
Mod. Fenestrated Jaw
FO-131

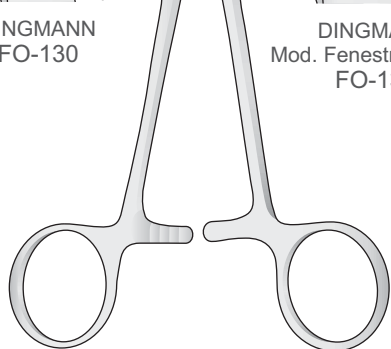

DINGMANN
FO-130/FO-131
190 mm

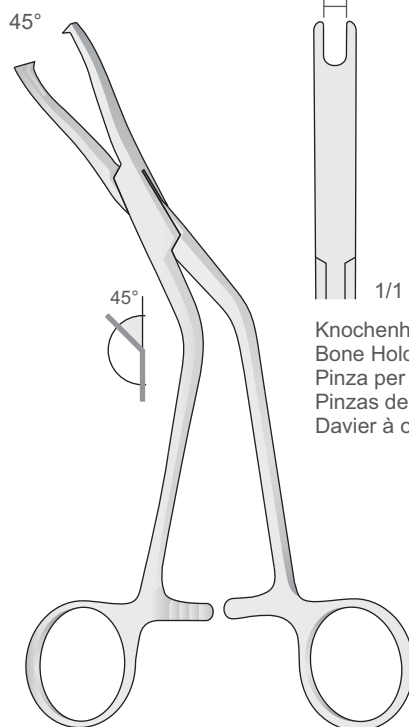

DINGMANN - Mod. Fenestrated Jaw
FO-131S
190 mm

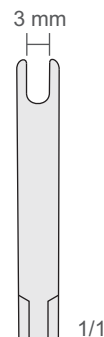

Knochenhaltezeuge
Bone Holding Forceps
Pinza per fissare l'osso
Pinzas de sujeción para hueso
Daviers à os

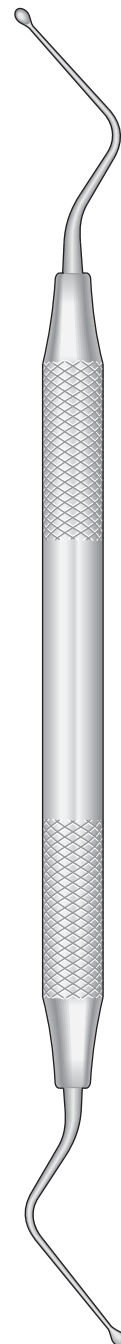

10

Periosteals (Raspatories)

Raspatorien
Rugines périostiques
Periostótomos (Legras)
Scollaperiosteí (Periostotomi)

Curettes

Küretten
Curettes
Curetas
Curettes

Bone files

Knochenfeilen
Limes à os
Limas para hueso
Lime per osso

Tissue Nippers

Gewebezängchen
Pincés coupante pour tissu
Pinzas para cortar tejidos
Tronchesi per gengive e tessuto

Bone Rongeurs

Hohlmeißelzangen
Pincés gouges
Pinzas gubias
Pinze ossivore

Bone Cutting Forceps

Knochensplitterzangen
Pincés coupantes à os
Pinzas cortantes para huesos
Pinze ossivore



Raspatorien
Periosteals (Raspatories)
Scollaperiostei (Periostotomi)
Periostótomos (Legras)
Rugines périostiques

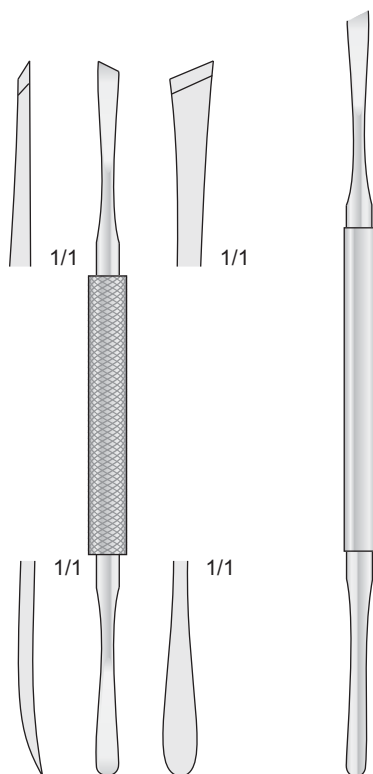

MEAD
165 mm

WEST
185 mm

**PERIOSTEAL
ELEVATORS**

**PERIOSTEAL
RASPATORIES**

Scharf - Sharp - Taglienti - Cortante - Tranchant

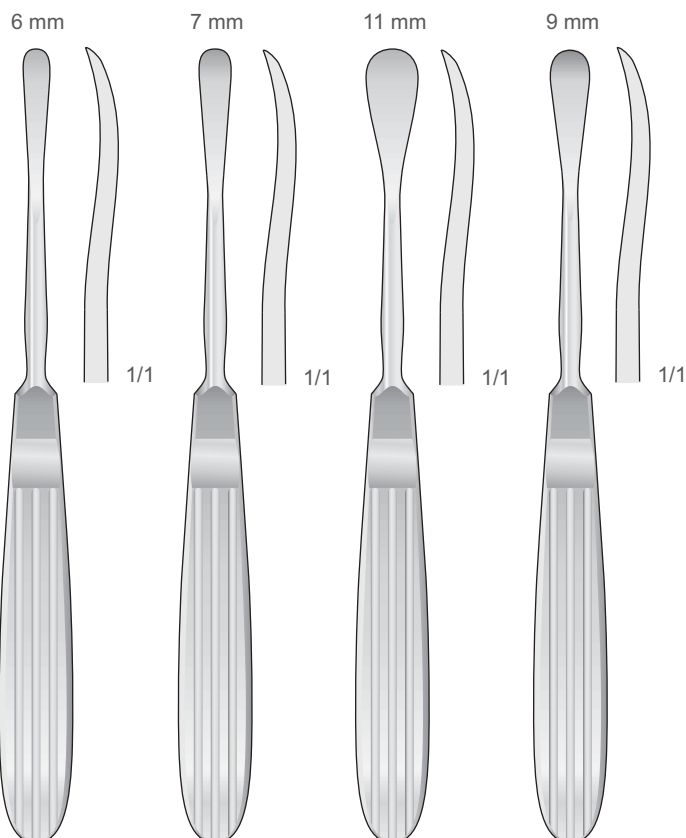

OBWEGESER
DO-59
175 mm

OBWEGESER
DO-63
175 mm

OBWEGESER
DO-65
175 mm

OBWEGESER
DO-67
175 mm

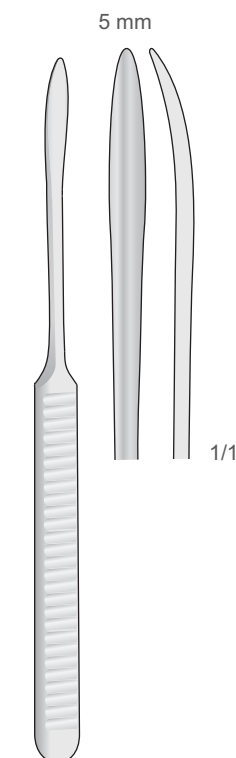

WILLIGER
WG-10
165 mm

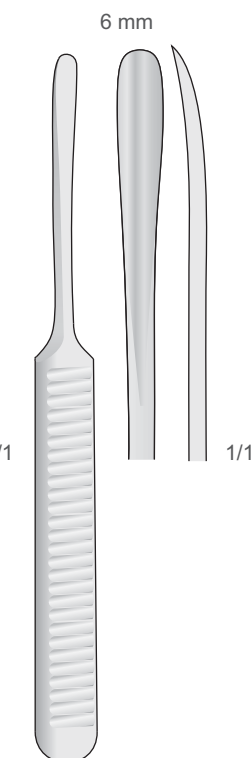

WILLIGER
WG-12
160 mm

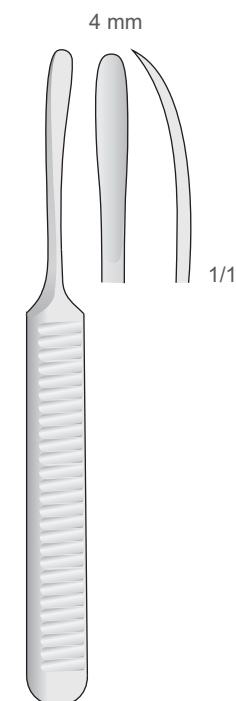

WILLIGER
WG-14
140 mm

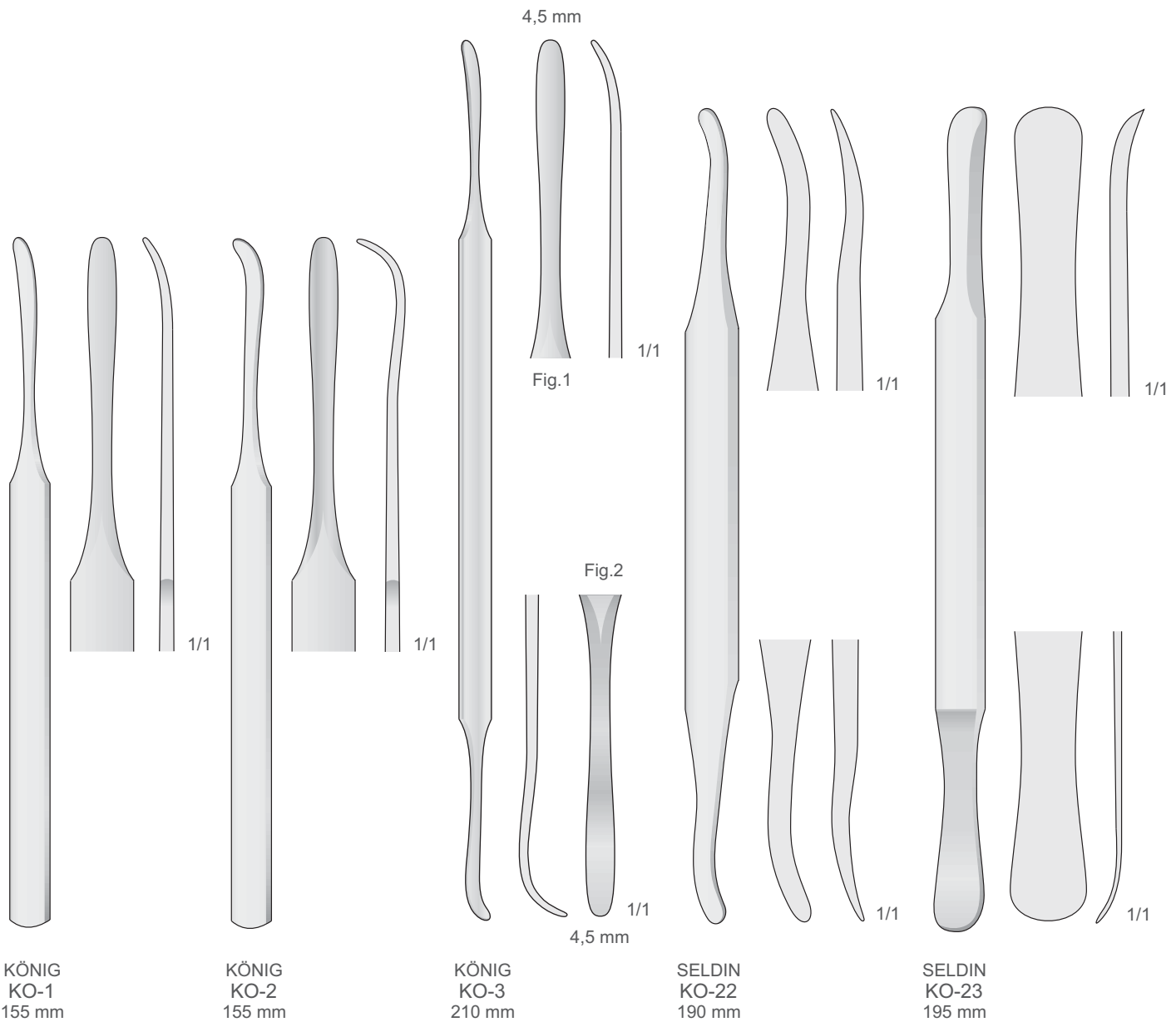



Raspatorien - Elevatorien
Raspatories - Elevators
Periostotomi - Elevatori
Legras - Elevadores
Rugines - Elevateurs

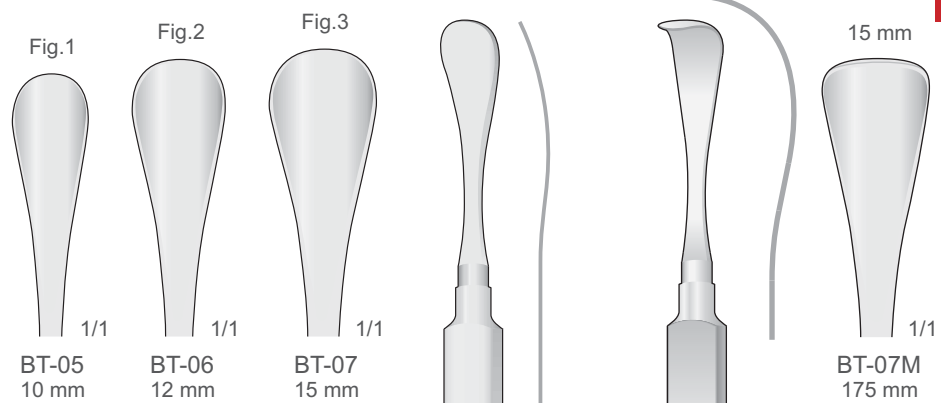

Halbscharf
Semi-Scharp
Semitagliante
Semicortante
Semitranchant

HENAHAN
BT-05/BT-07
175 mm

HENAHAN
BT-07M
175 mm

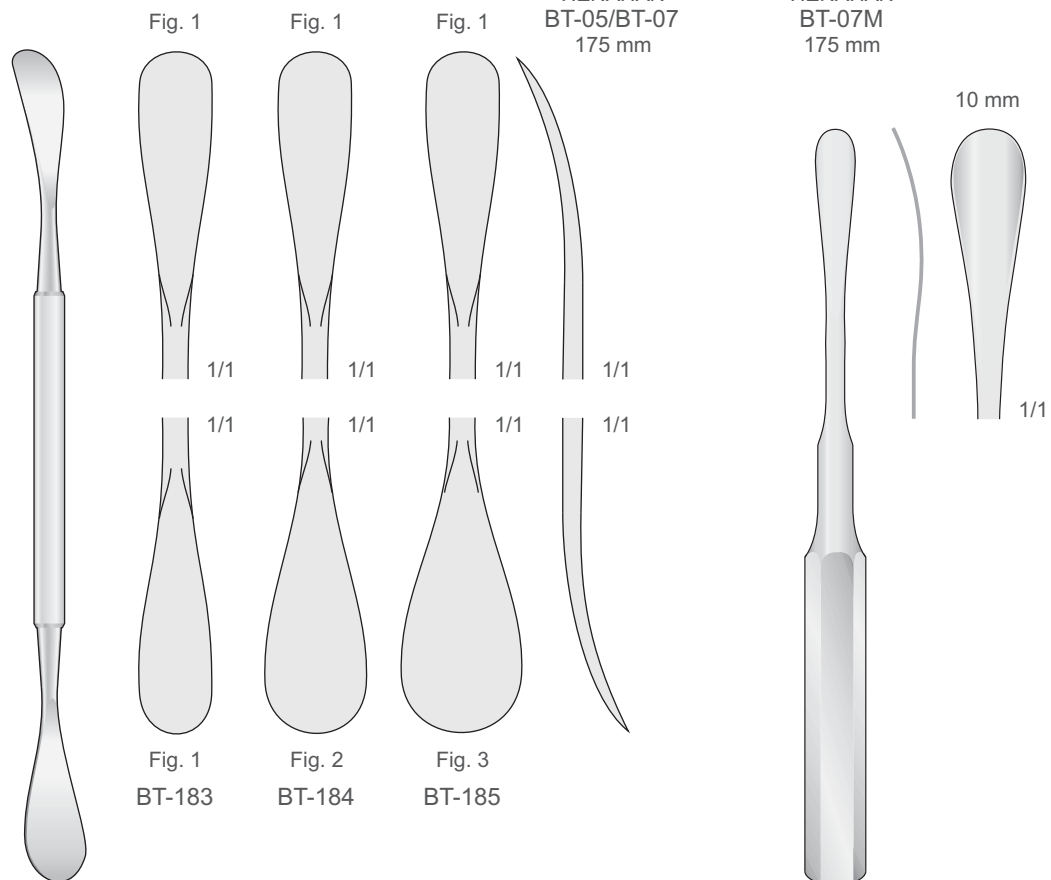

HENAHAN
BT-183/BT-185
200 mm

MOLT
MO-15
160 mm

Fig. 12S

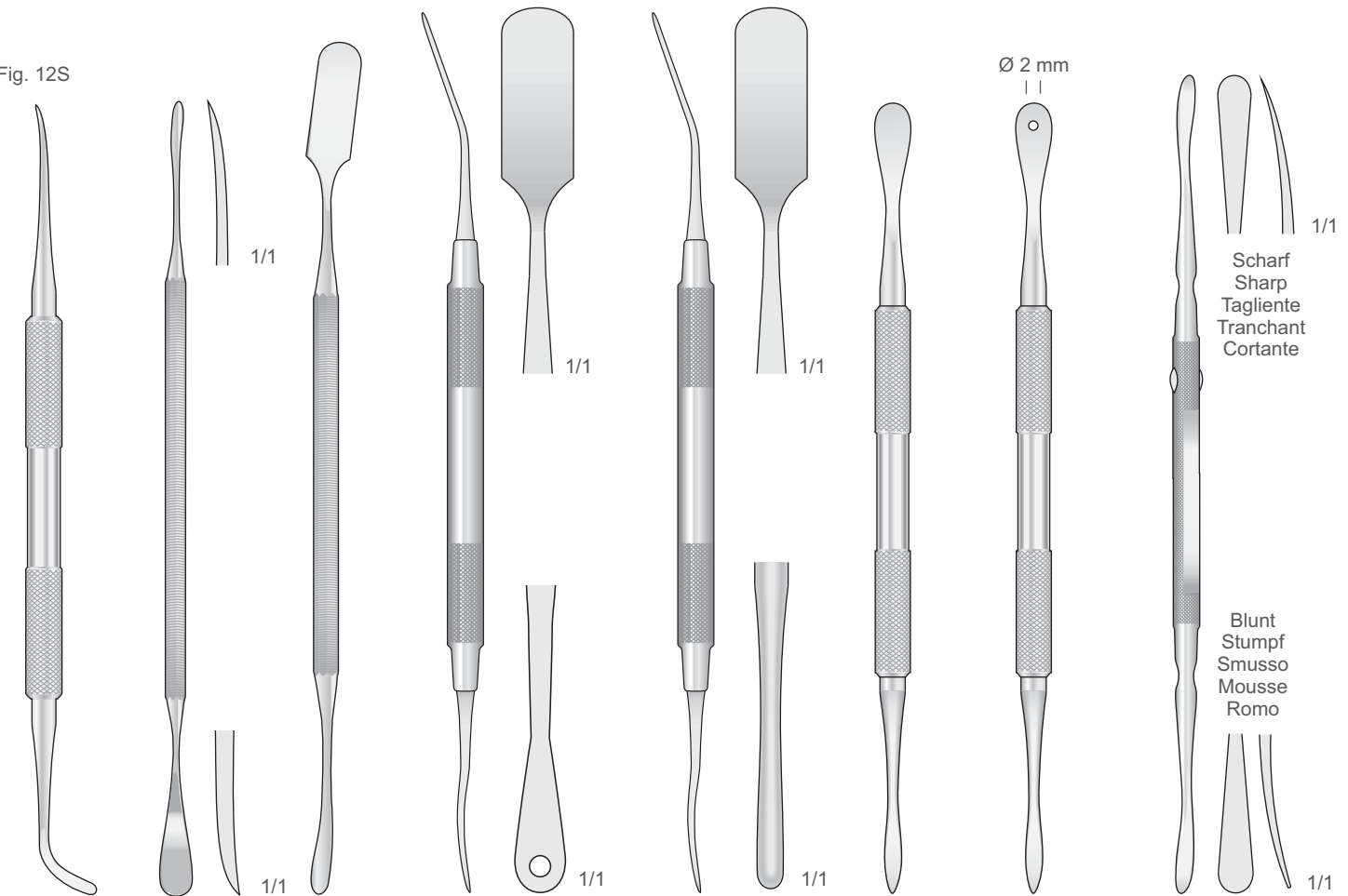

BENNETT
KO-58
175 mm

MOLT-9
175 mm

PR-3
190 mm

PRICHARD
PR-3A
180 mm

PRICHARD
718-PR3
175 mm

MOLT
718-M9
170 mm

MOLT
MO-9A
170 mm

FREER
180 mm

Scharf
Sharp
Tagliente
Tranchant
Cortante

Blunt
Stumpf
Smusso
Mousse
Romo



Raspatorien - Elevatorien
Raspatories - Elevators
Periostotomi - Elevatori
Legras - Elevadores
Rugines - Elevateurs

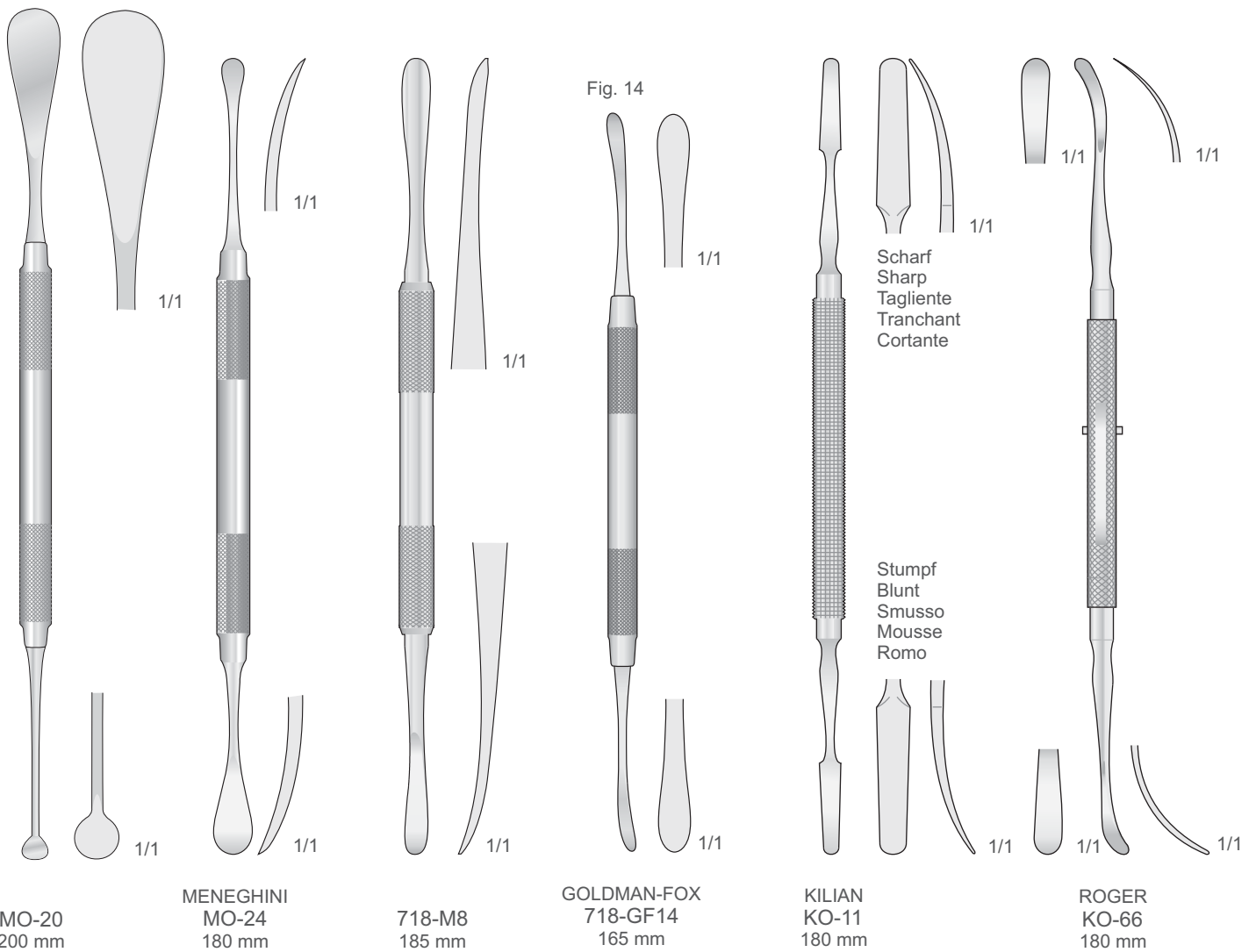

Raspatorien - Elevatorien
Raspatories - Elevators
Periostotomi - Elevatori
Legras - Elevadores
Rugines - Elevateurs

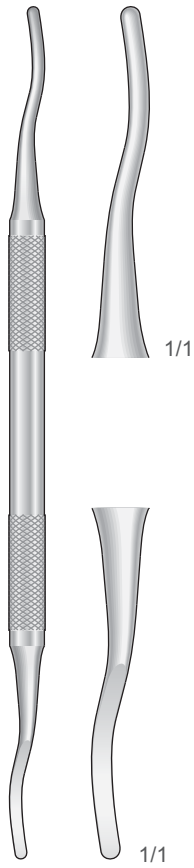

HOPKINS
718-191
185 mm

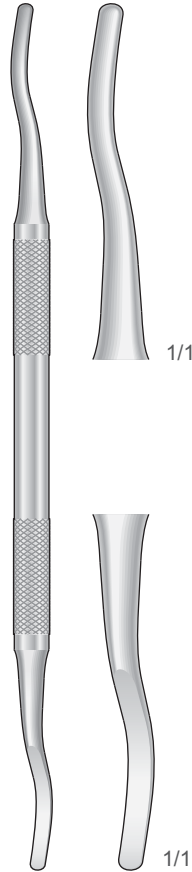

HOPKINS
718-192
185 mm

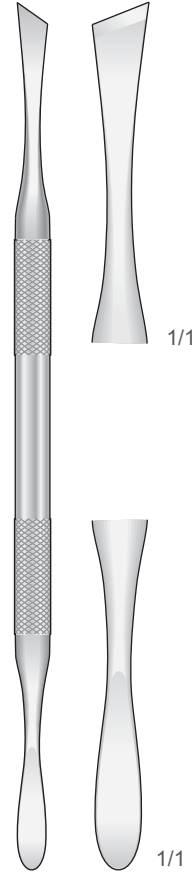

MEAD
718-223
185 mm

Instrumente für Sinuslift / Sinus Lift Instruments / Strumenti per rialzo del seno
Instrumentos para elevación de seno maxilar / Instruments d'élevation sinusienne

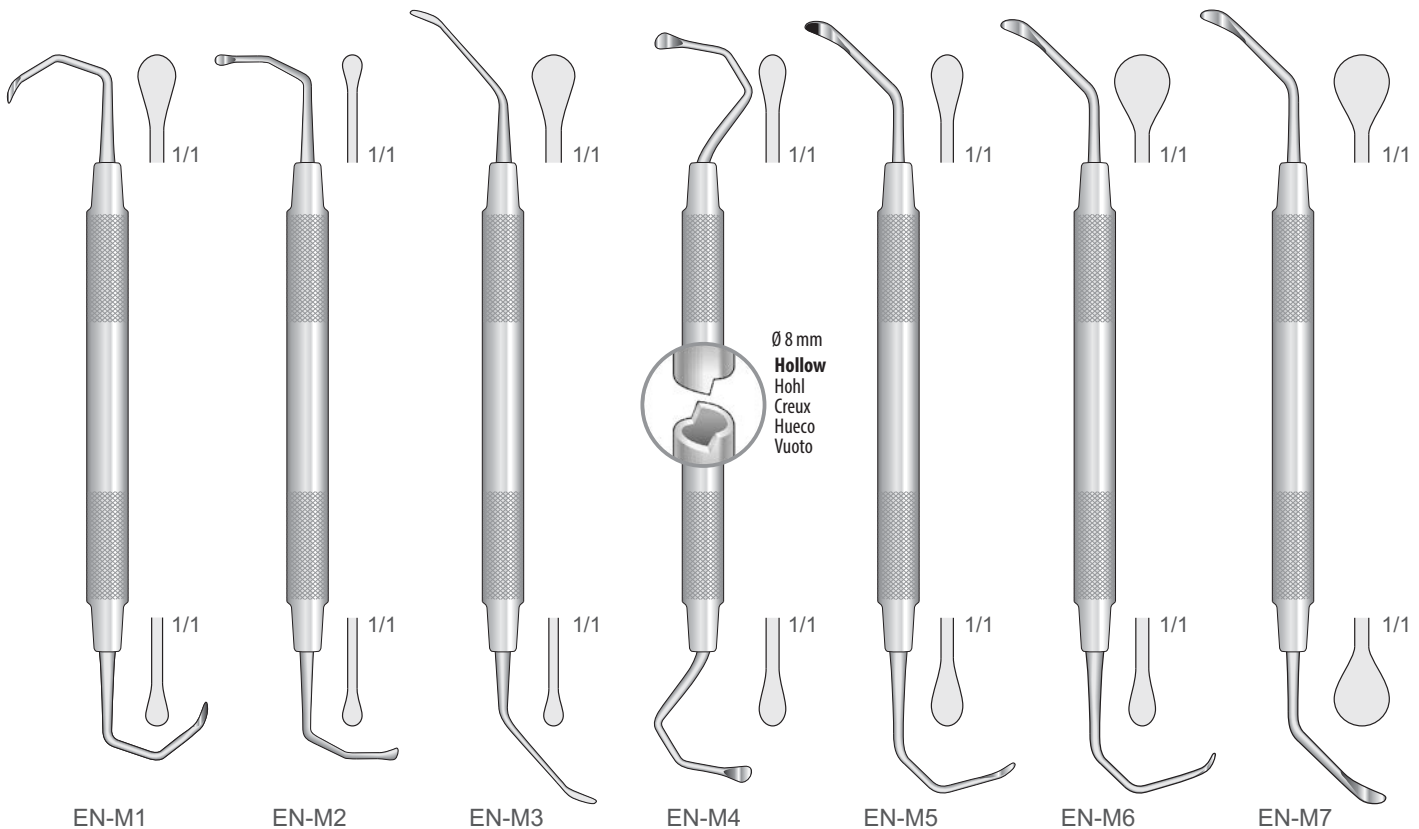

EN-M1

EN-M2

EN-M3

EN-M4

EN-M5

EN-M6

EN-M7



Raspatorien - Elevatorien
Raspatories - Elevators
Periostotomi - Elevatori
Legras - Elevadores
Rugines - Elevateurs

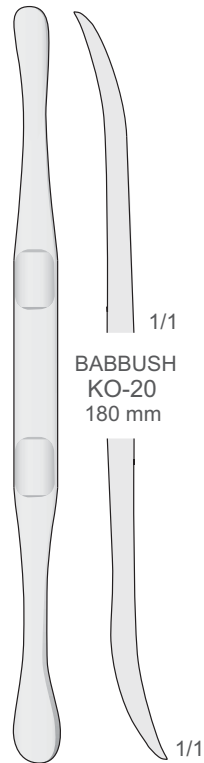

BABBUSH
KO-20
180 mm

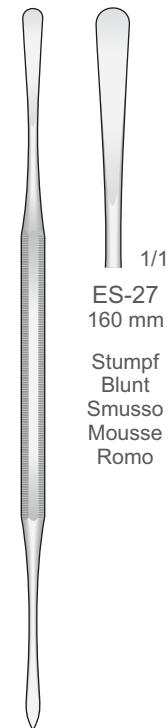

ES-27
160 mm
Stumpf
Blunt
Smusso
Mousse
Romo

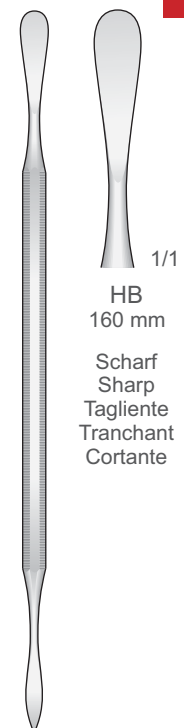

HB
160 mm
Scharf
Sharp
Tagliente
Tranchant
Cortante

Instrumente für Sinuslift
Sinus Lift Instruments
Strumenti per rialzo del seno
Instrumentos para elevación de seno maxilar
Instruments d'élevation sinusienne

Fig. 24G

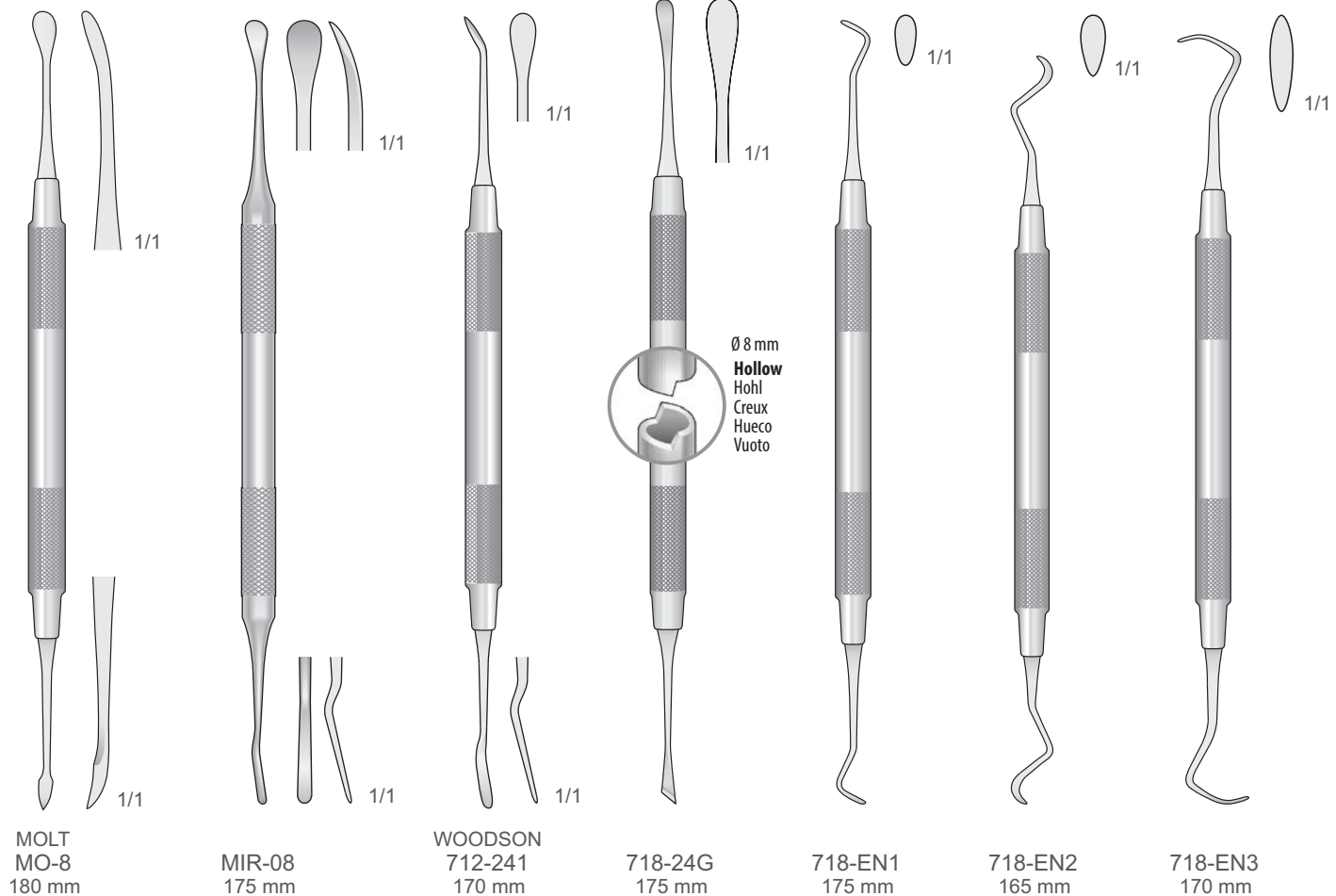

MOLT
MO-8
180 mm

MIR-08
175 mm

WOODSON
712-241
170 mm

718-24G
175 mm

718-EN1
175 mm

718-EN2
165 mm

718-EN3
170 mm

Raspatorien - Elevatorien
Raspatories - Elevators
Periostotomi - Elevatori
Legras - Elevadores
Rugines - Elevateurs

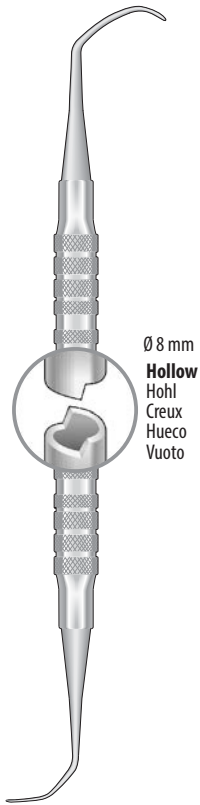

Ø 8 mm
Hollow
Hohl
Creux
Hueco
Vuoto

TASO-1

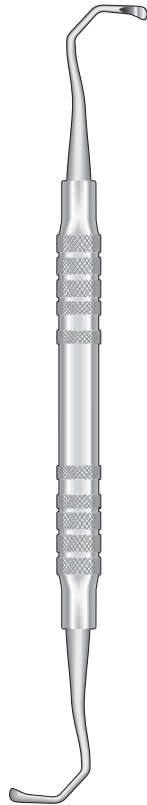

TASO-2



TASO-3

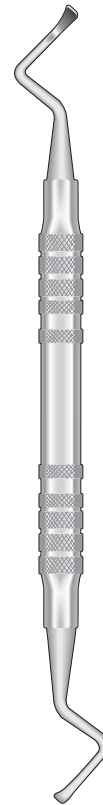

TASO-4

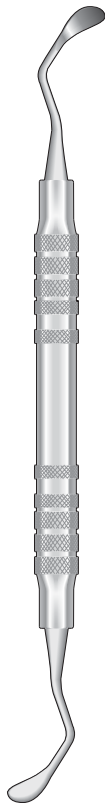

TASO-5



TASO-6

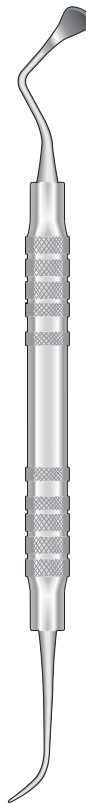

TASO-7



Ø 8 mm
Hollow
Hohl
Creux
Hueco
Vuoto

TASO-8



Raspatorien
Raspatories
Periostotomi
Legras
Rugines

Curettes
Küretten
Curettes
Curetas
Curettes

Instrumente für Sinuslift
Sinus Lift Instruments
Strumenti per rialzo del seno
Instrumentos para elevación de seno maxilar
Instruments d'élévation sinusienne

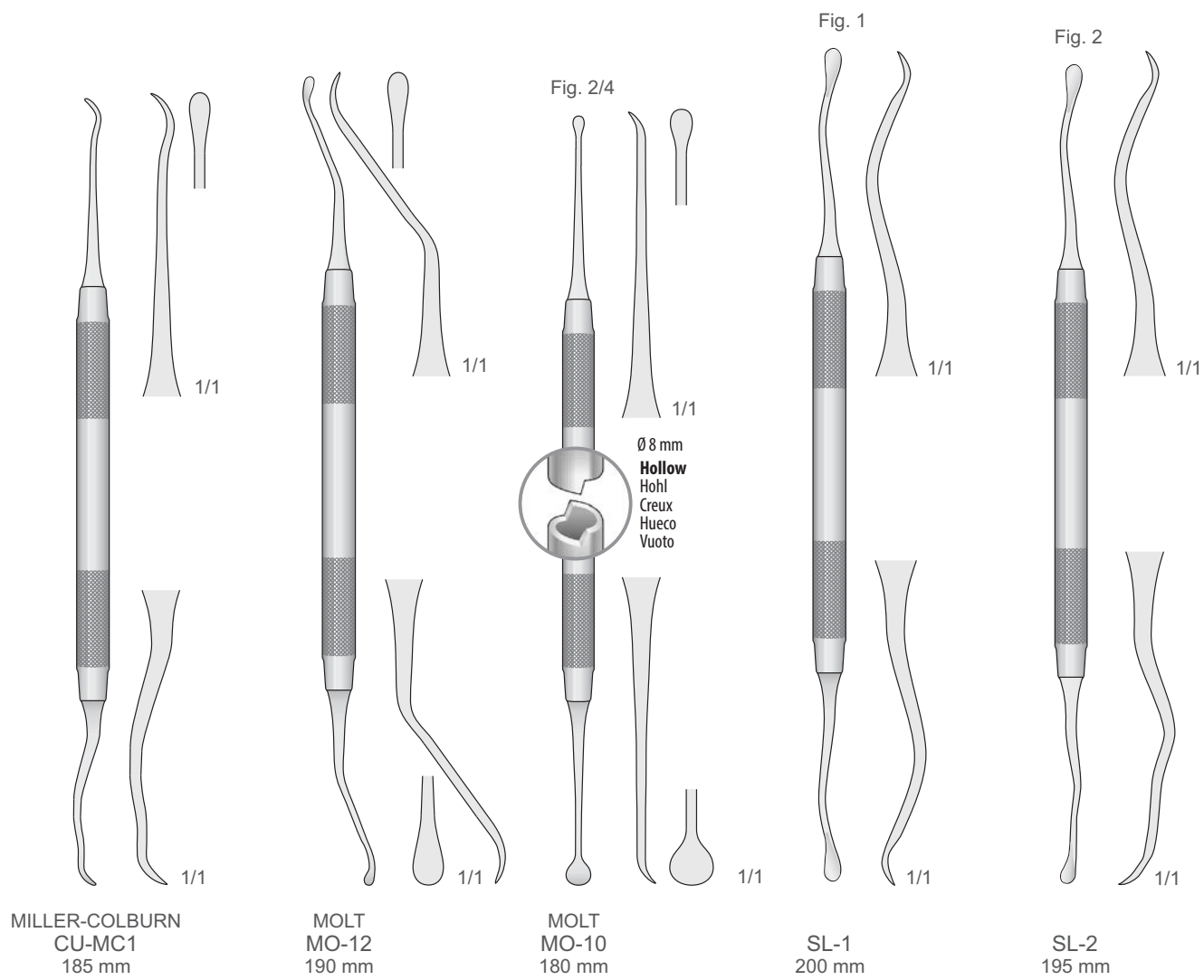

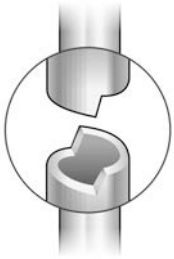

Runder Hohlgriff 8 mm
Hollow Round Handle 8 mm
Manico tondo vuoto 8 mm
Mango hueco 8 mm
Manche rond vide 8 mm

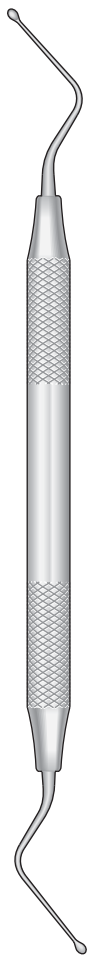

HEMINGWAY
720-101/720-104
180 mm

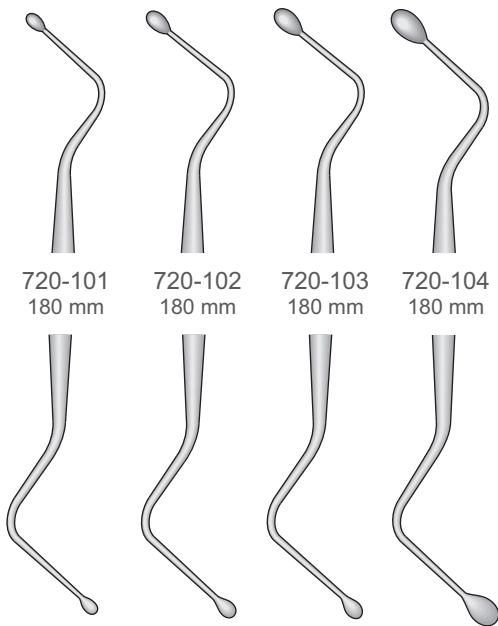

720-101 180 mm
720-102 180 mm
720-103 180 mm
720-104 180 mm

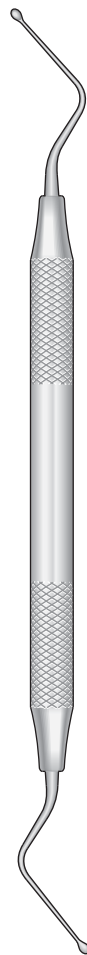

LUCAS
720-85/720-88
180 mm

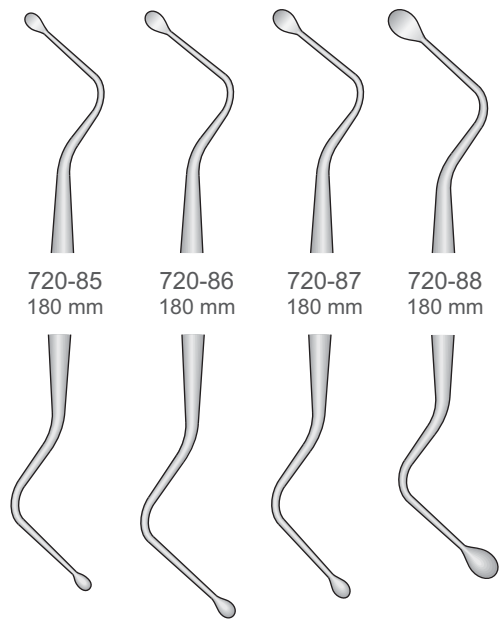

720-85 180 mm
720-86 180 mm
720-87 180 mm
720-88 180 mm



Küretten
Curettes
Curettes
Curetas
Curettes

10

Wundhachen Mandibular
Mandibular Nerve Diplace
Per spostamento
nervo mandibolare
Para nero mandibular

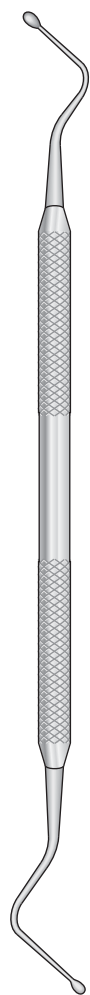

HEMINGWAY
C-1
170 mm

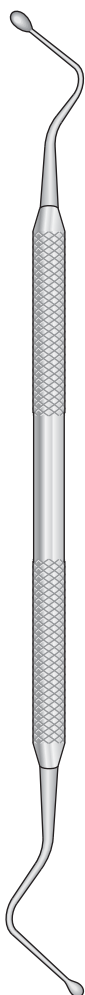

HEMINGWAY
C-2
170 mm

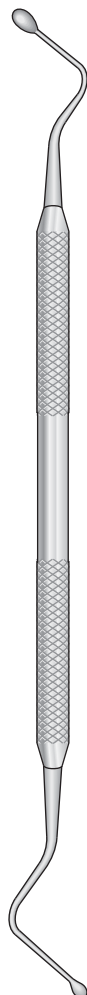

HEMINGWAY
C-3
170 mm

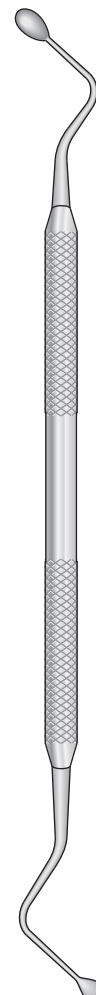

HEMINGWAY
C-4
170 mm

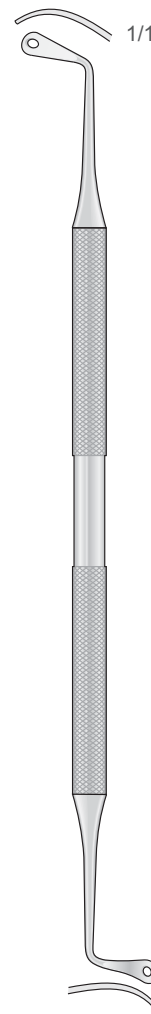

SL-21
165 mm

10

Küretten
Curettes
Curettes
Curetas
Curettes

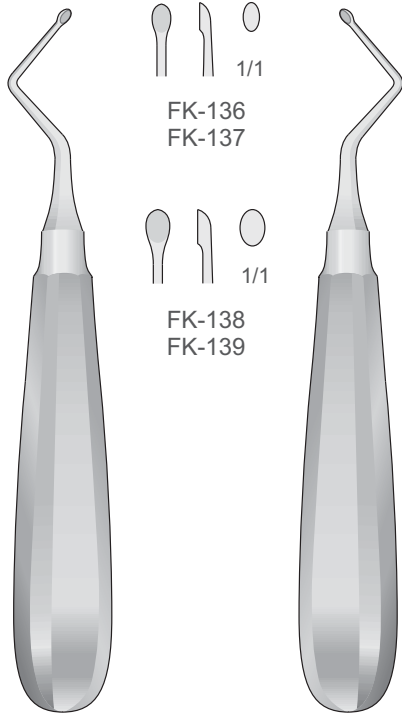

FK-136
FK-137

FK-138
FK-139

KERPEL
FK-136
FK-138
145 mm

KERPEL
FK-137
FK-139
145 mm



DL-50
155 mm



DL-51
150 mm



DL-52
150 mm

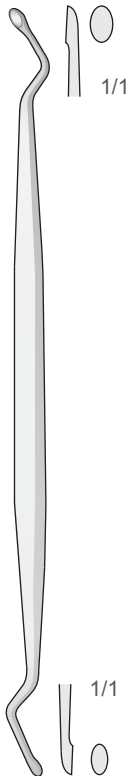

FK-83
160 mm

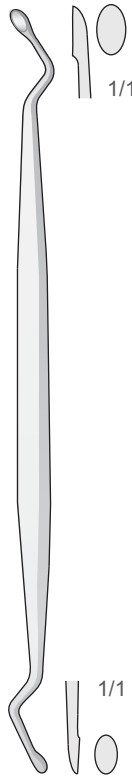

JANSEN
FK-84
160 mm

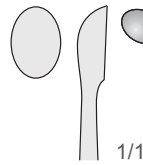

UFFENORDE
FK-188
170 mm

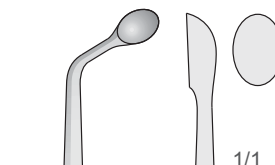

UFFENORDE
FK-189
170 mm

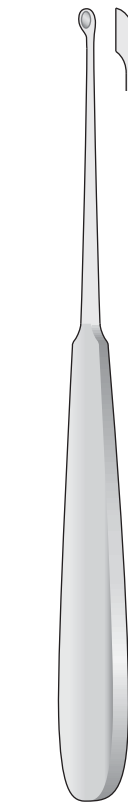
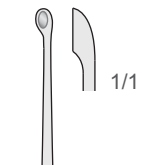

WILLIGER
FK-197/FK-198
170 mm

Fig. 00
3,4 mm



1/1
FK-197

Fig. 1
5,2 mm



1/1
FK-198



Küretten
Curettes
Curettes
Curetas
Curettes

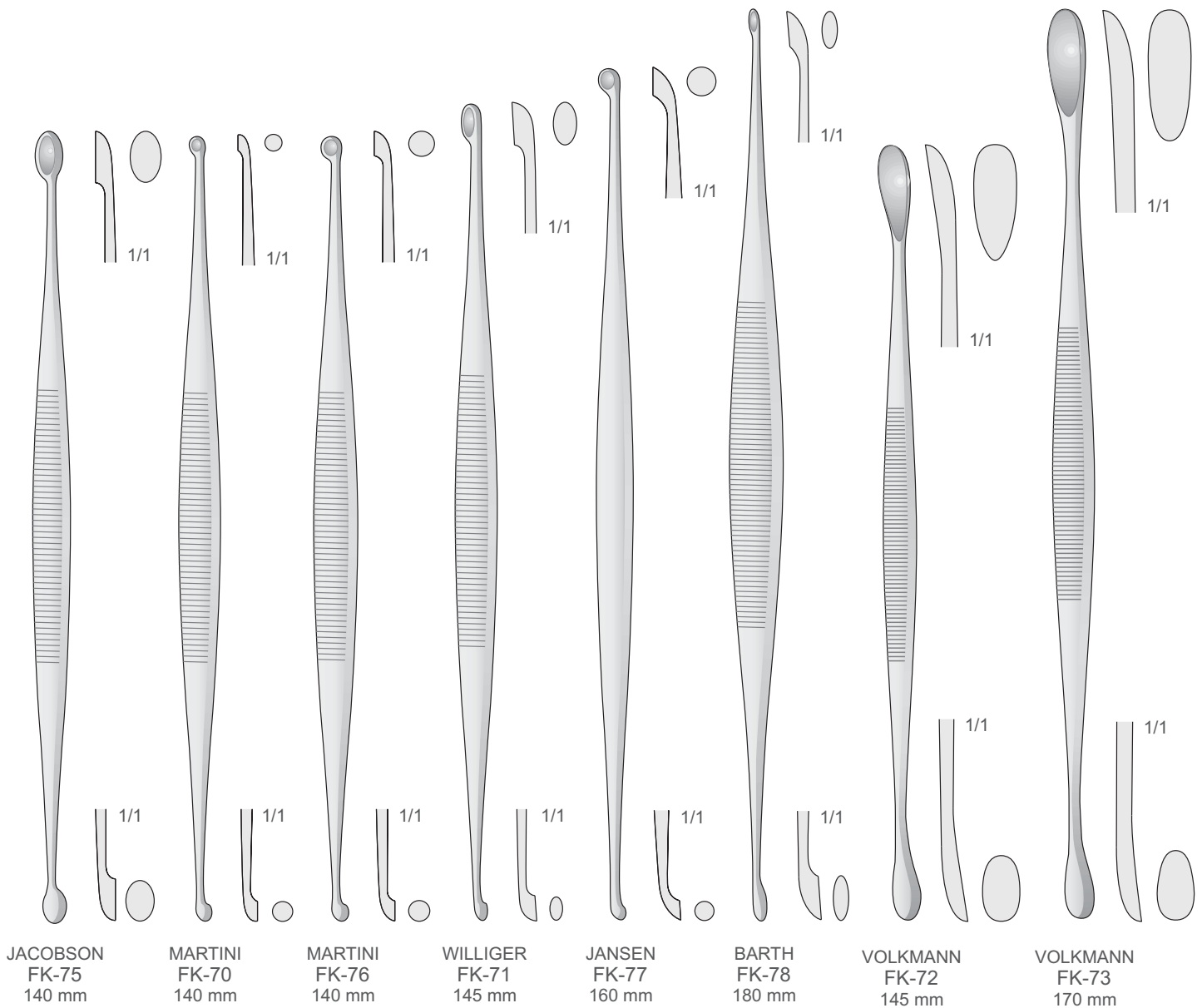

10

Küretten
Curettes
Curettes
Curettes
Curettes

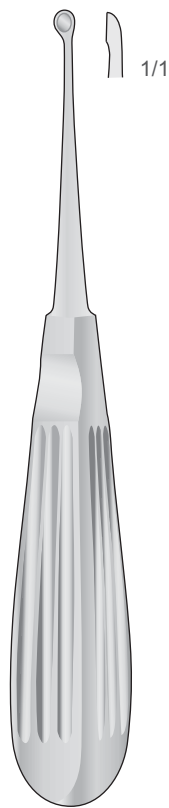

Fig.0000
2,8 mm
1/1
FK-60

Fig.000
3,6 mm
1/1
FK-61

Fig.00
4,4 mm
1/1
FK-62

,Fig.0
5,2 mm
1/1
FK-63

Fig.1
6,8 mm
1/1
FK-64

Fig.2
8,5 mm
1/1
FK-65

Fig.3
10 mm
1/1
FK-66

Fig.4
11,5 mm
1/1
FK-67

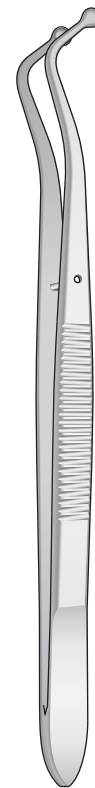

VOLKMANN
FK-60/FK-67
170 mm

COLLEGE CURETTE
MIR-10
160 mm

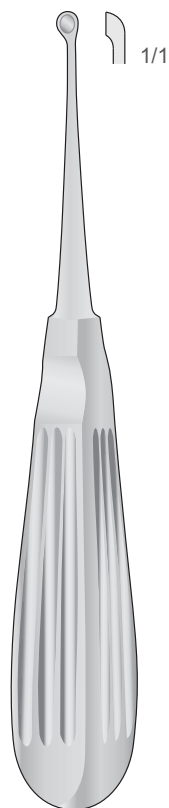

3 mm
1/1
FK-110

4 mm
1/1
FK-111

5 mm
1/1
FK-112

6 mm
1/1
FK-113

8 mm
1/1
FK-114

10 mm
1/1
FK-115

12 mm
1/1
FK-116

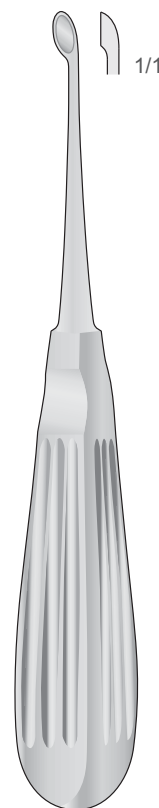

2,5 mm
1/1
FK-120

3,4 mm
1/1
FK-121

4,2 mm
1/1
FK-122

5,2 mm
1/1
FK-123

6,3 mm
1/1
FK-124

7,4 mm
1/1
FK-125

8 mm
1/1
FK-126

BRUNS
FK-110/FK-116
165 mm

SCHEDE
FK-120/FK-126
170 mm



Chirurgische Küretten
Surgical Curettes
Curette chirurgique
Curetas quirúrgicas
Curettes chirurgicales

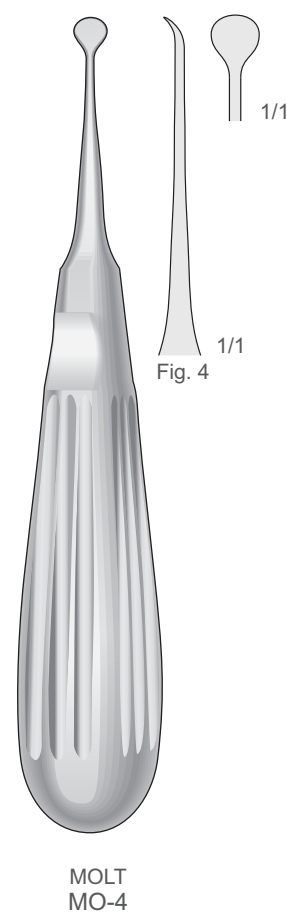
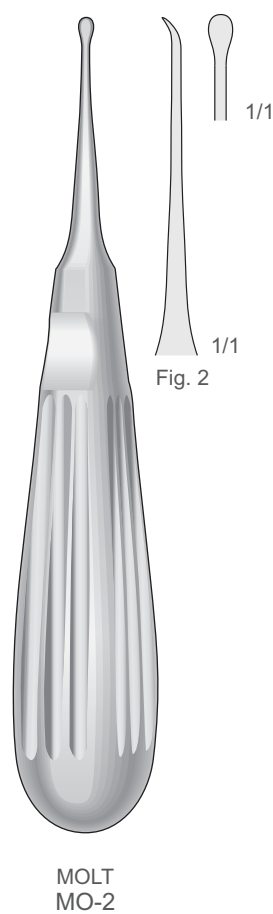
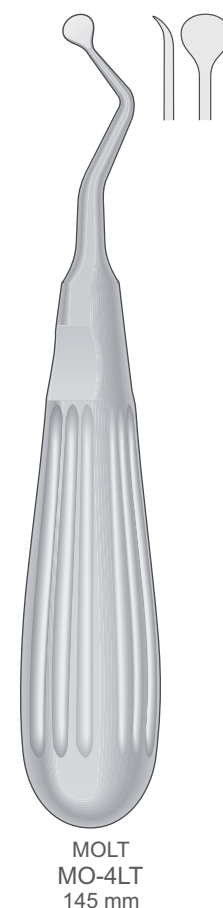
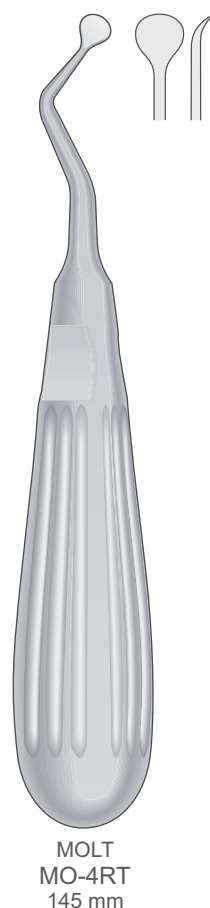
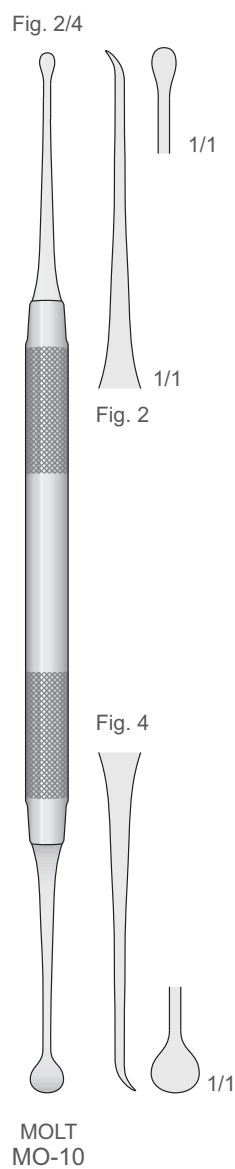
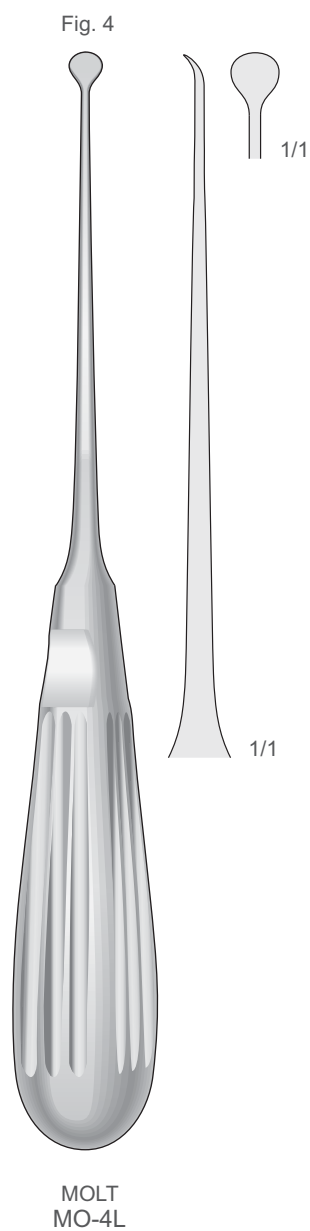
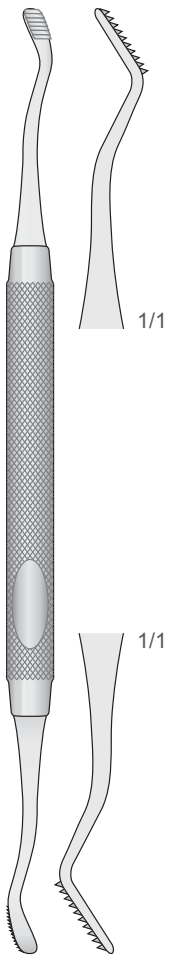
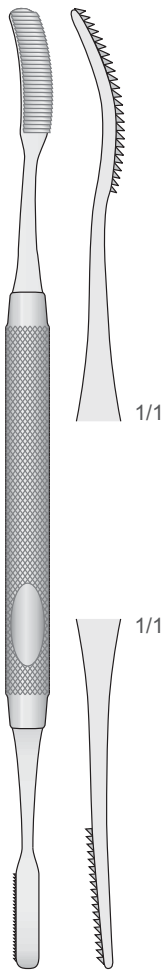

Fig. 67



HOWARD
DO-1
180 mm

Fig. 45



MILLER
DO-2
185 mm

Fig. 52

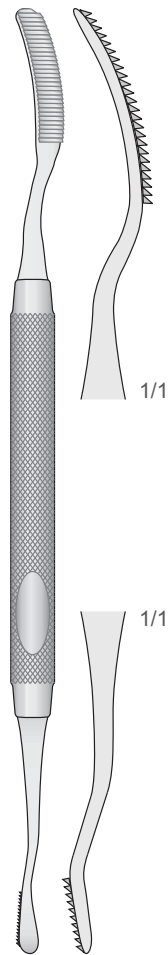

MILLER
DO-3
180 mm

Fig. 12

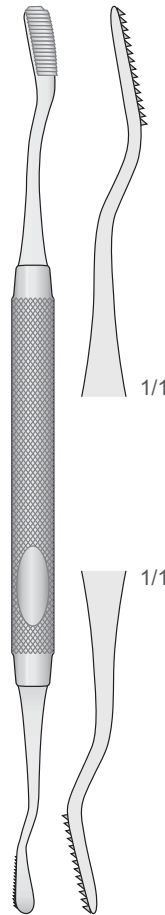

HOWARD
DO-4
170 mm

Fig. 12A

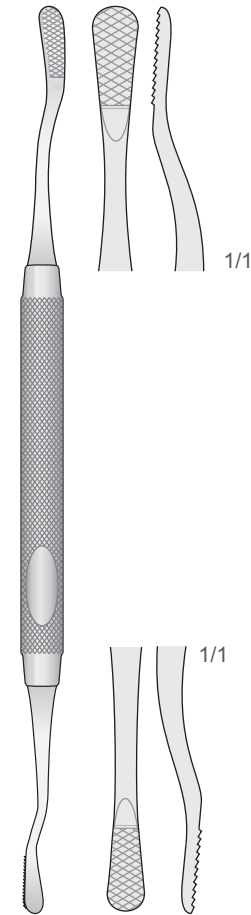

MILLER
DO-4C
170 mm

Fig. 64

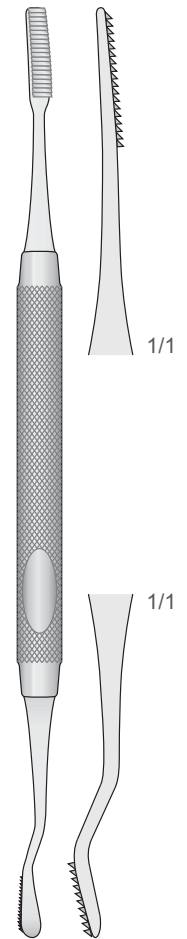

MILLER
DO-5
175 mm



Knochenfeilen
Bone Files
Lime per osso
Limas para hueso
Limes à os

Runder Hohlgriff 8 mm
Hollow Round Handle 8 mm
Manico tondo vuoto 8 mm
Mango hueco 8 mm
Manche rond vide 8 mm

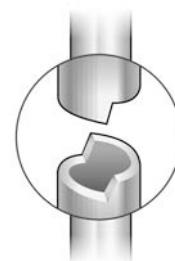

Parodontal Feilen
Periodontal Files
Lime parodontali
Limas parodontales
Limes parodontales

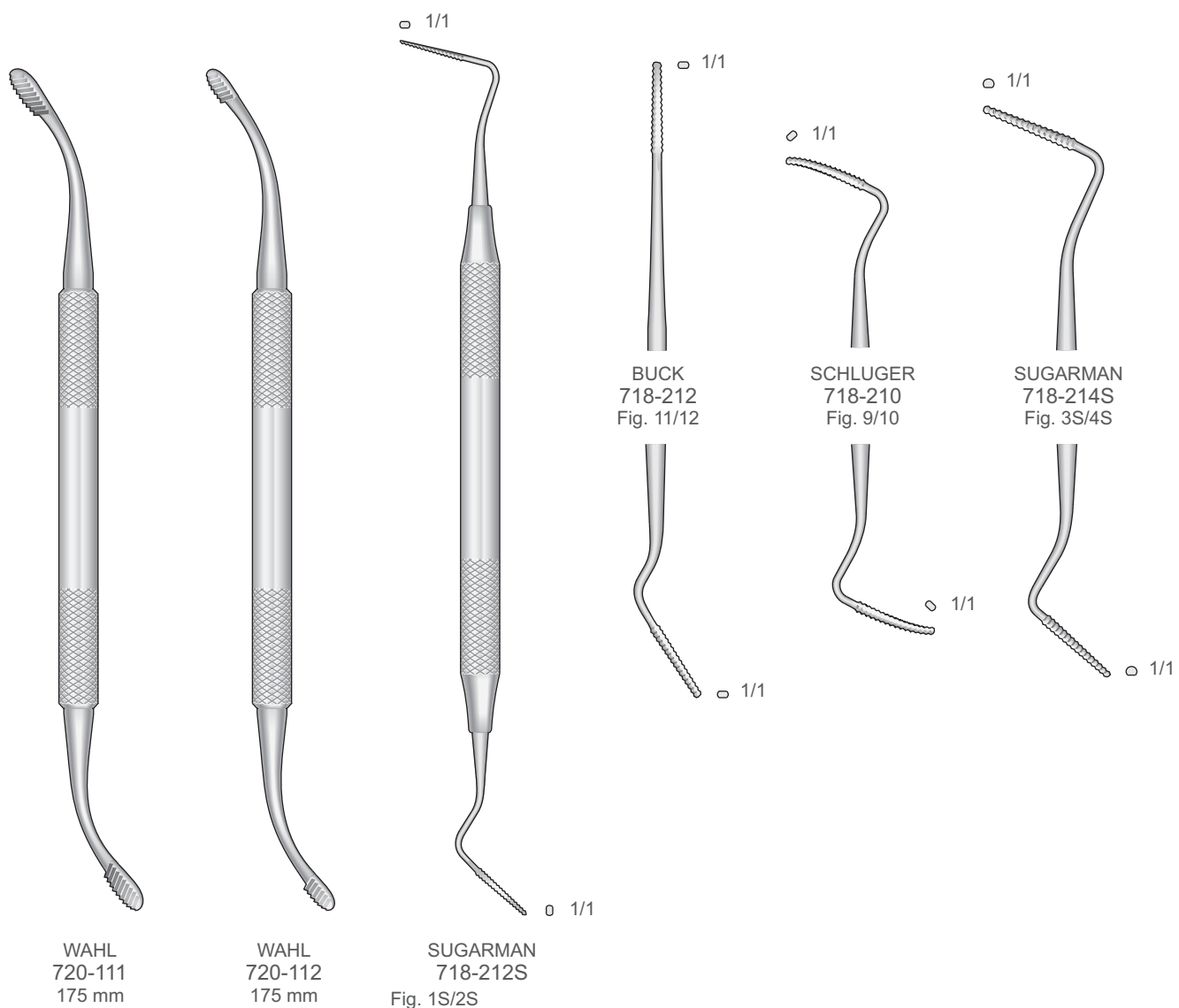

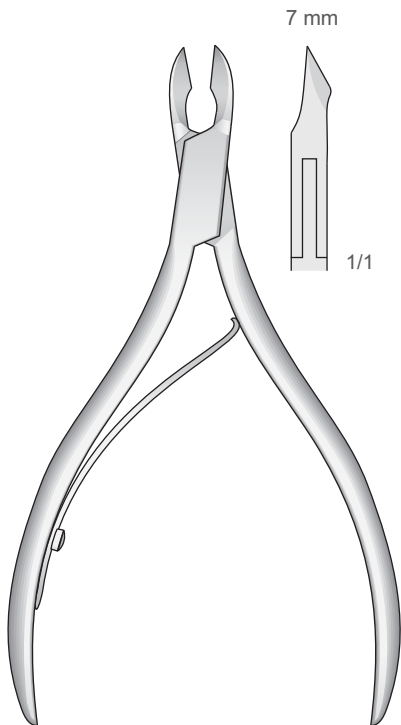

CHOEN
LX-60
105 mm

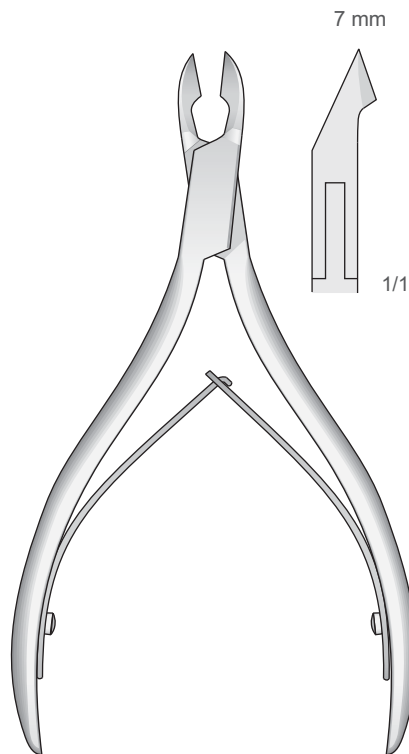

ILIC
LX-50
115 mm

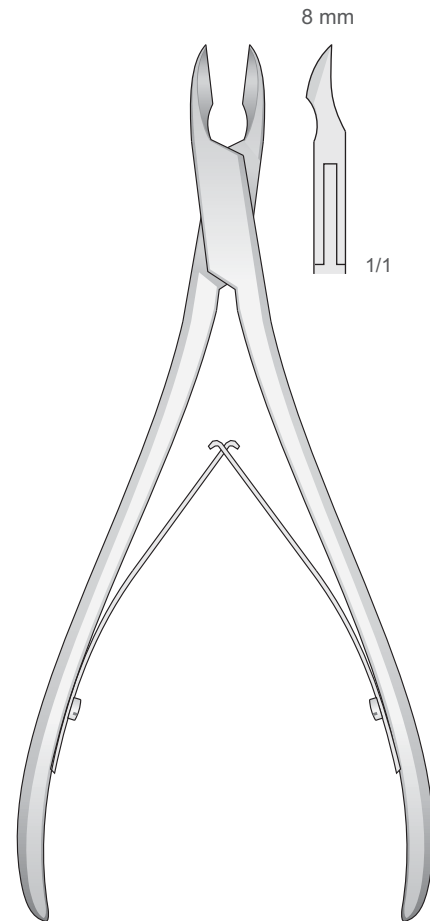

LX-52
140 mm



Hohlmeißelzangen
Bone rongeurs
Pinze ossivore
Pinzas gubias
Pincas gouges

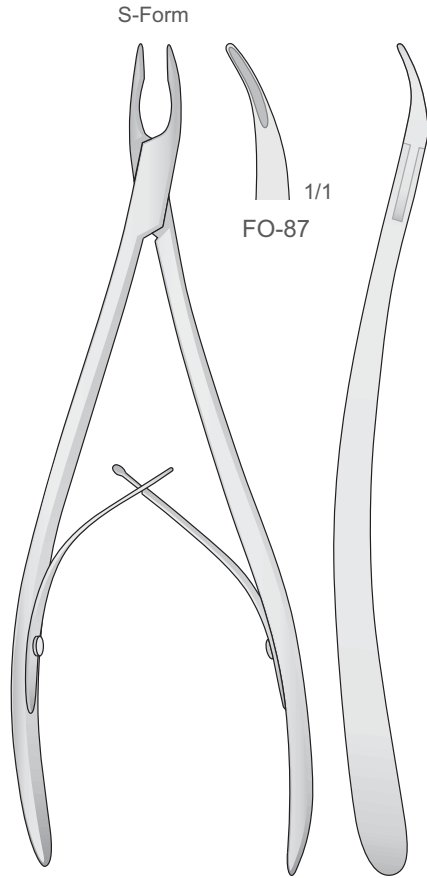

S-Form

FO-87



FO-88 FO-89

STELLBRINK
FO-87
190 mm

STELLBRINK
FO-88/FO-89
170 mm

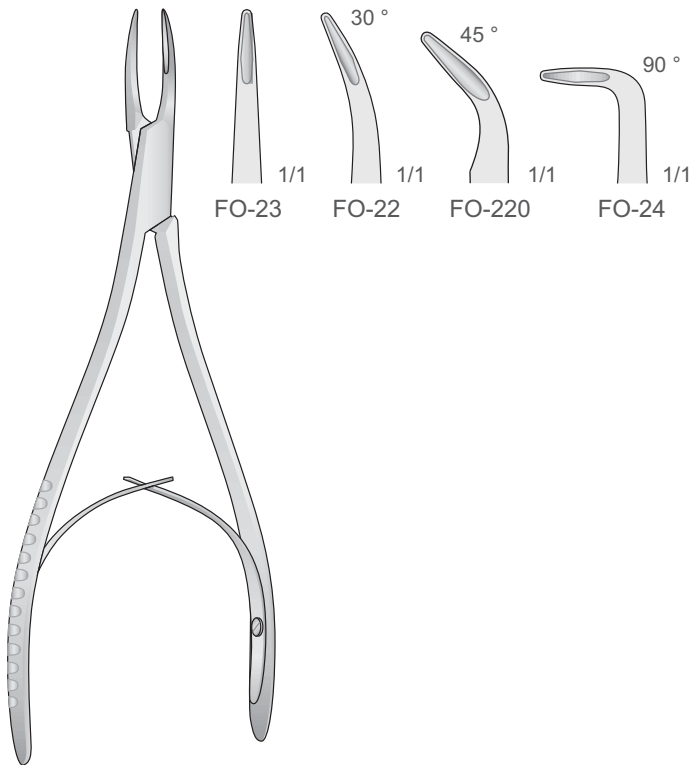

FO-23 FO-22 FO-220 FO-24

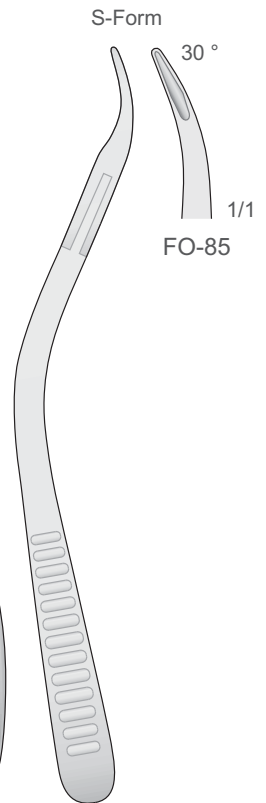

FO-85

MINI-FRIEDMANN
FO-22/FO-220
150 mm

MINI-FRIEDMANN
FO-85
145 mm

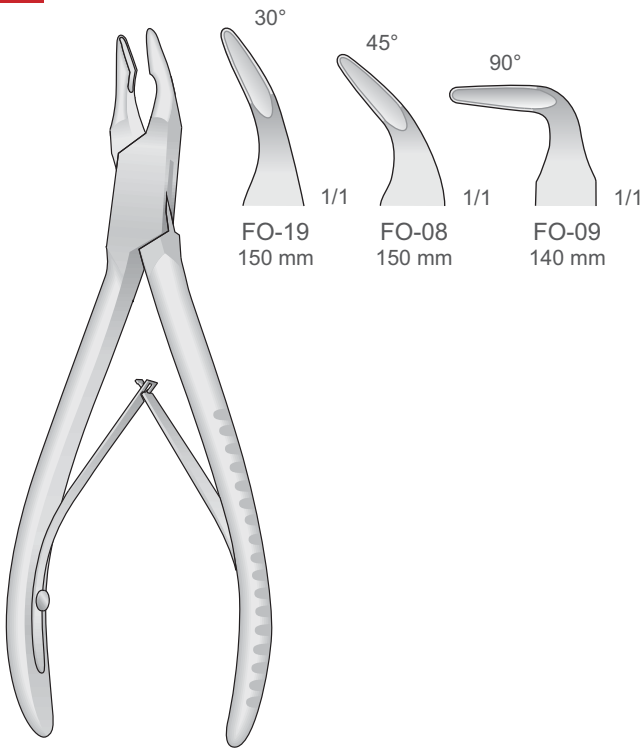

BLUMENTHAL
FO-08/FO-19

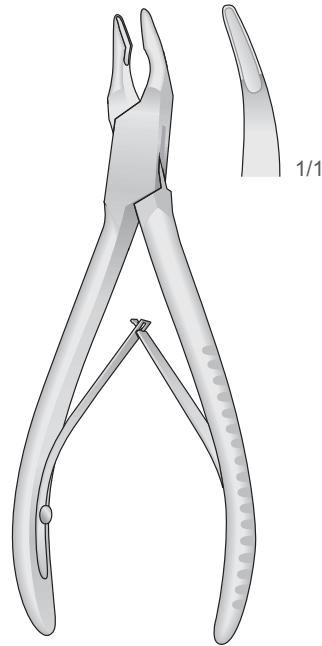

MINI FRIEDMAN
FO-15
120 mm

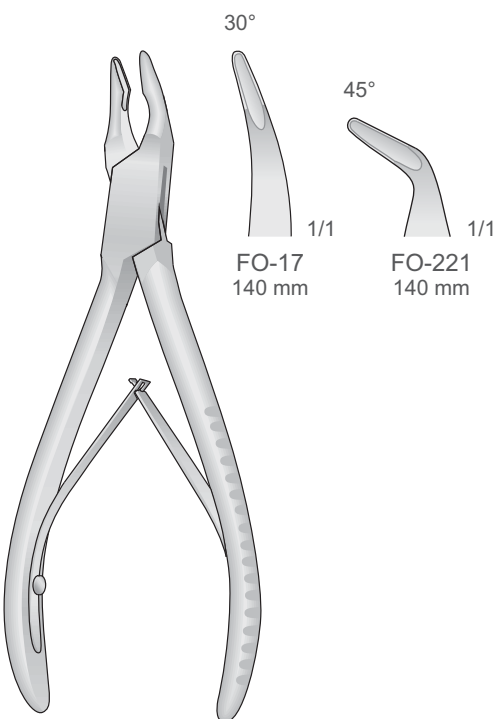

FRIEDMANN
FO-17/FO-221
140 mm

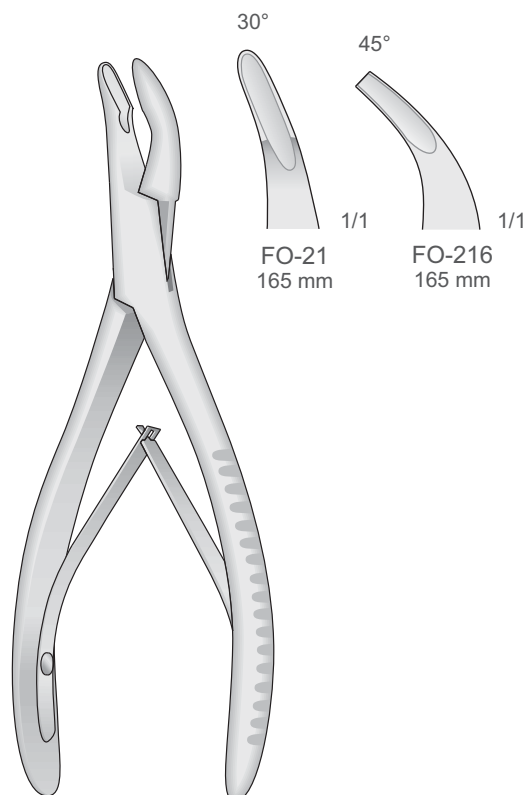

MEAD
FO-21/FO-216
165 mm



Hohlmeißelzangen
Bone rongeurs
Pinze ossivore
Pinzas gubias
Pincas gouges

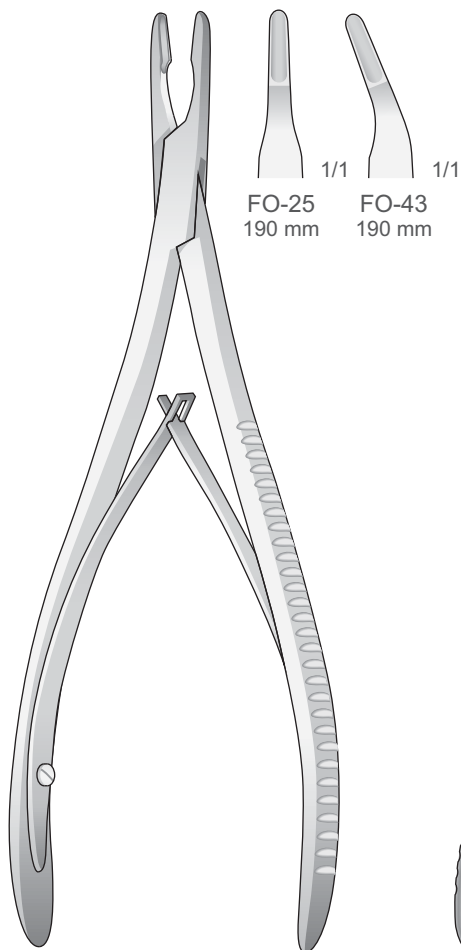

LEMPERT
FO-25/FO-43
190 mm

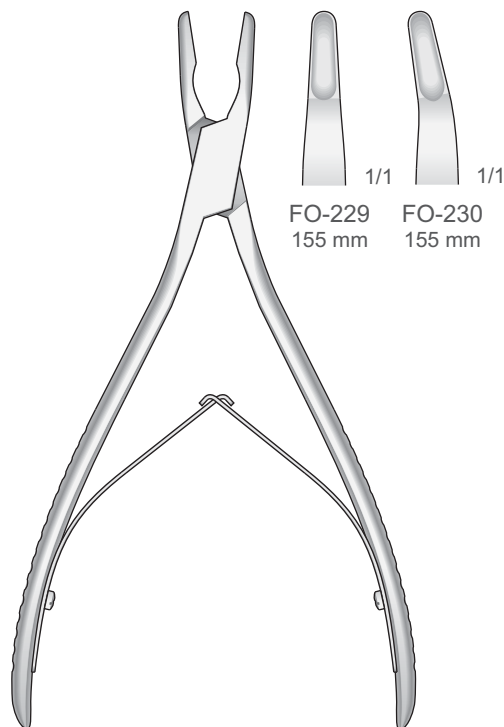

LEMPERT
FO-229/FO-230
155 mm

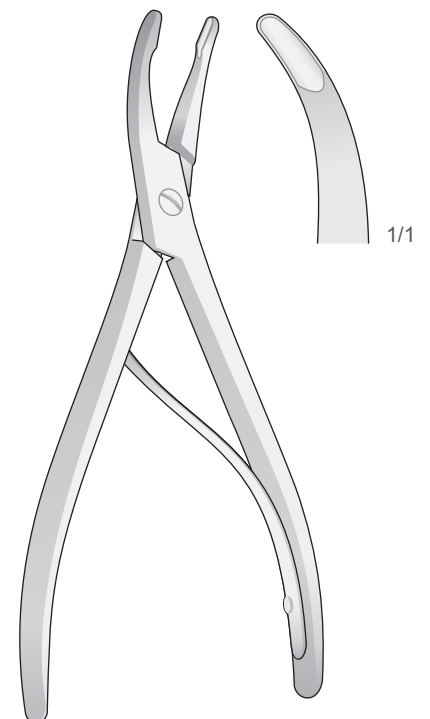

LUER
FO-18
155 mm

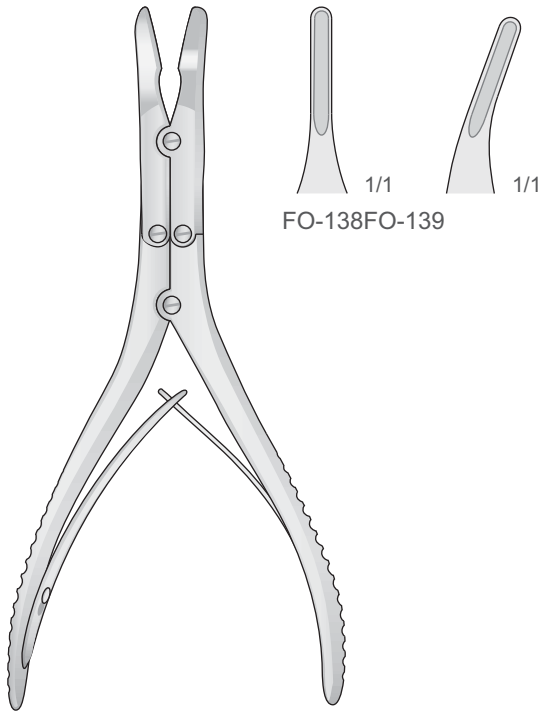

RUSKIN
FO-138/FO-139
150 mm

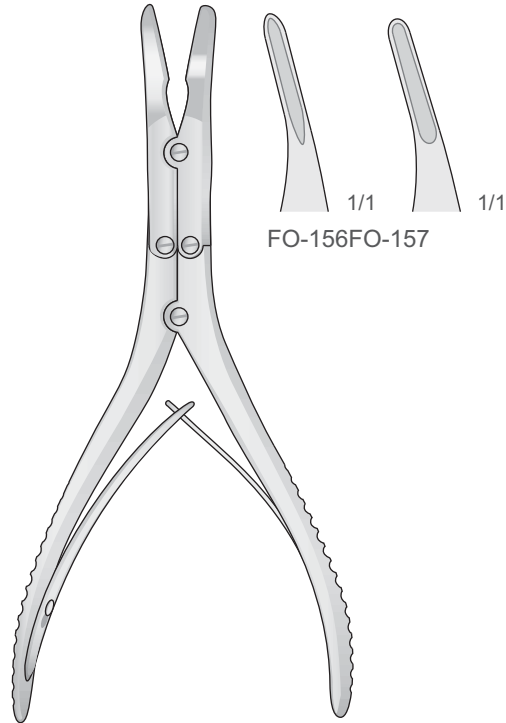

KLEINERT-KUTZ
FO-156/FO-157
155 mm

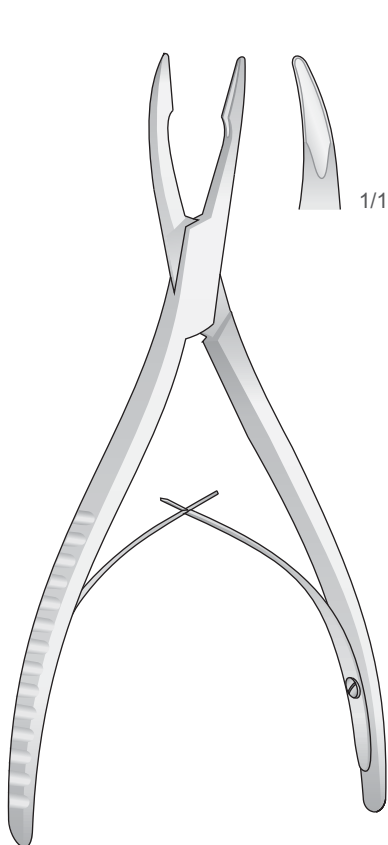

FRIEDMANN
FO-16
160 mm

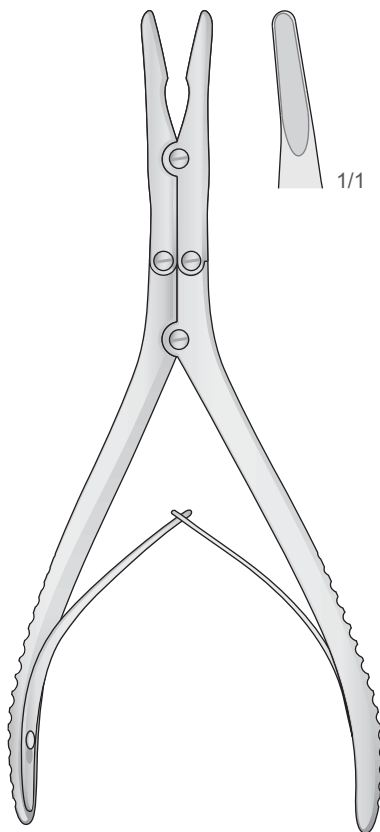

BEYER
FO-20
180 mm

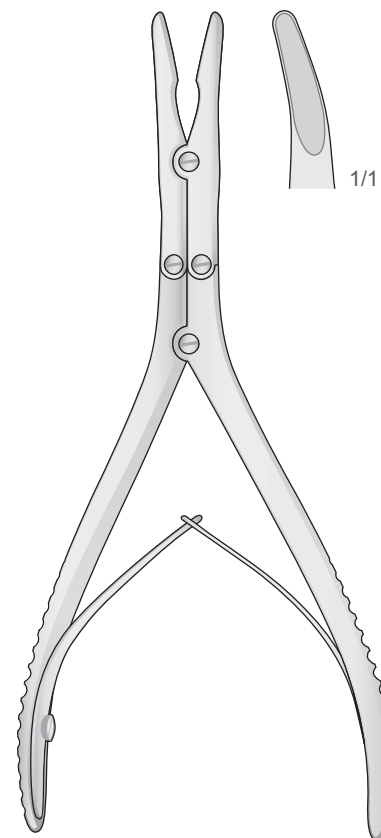

ZAUFAL-JANSEN
FO-34
180 mm



Hohlmeißelzangen
Bone rongeurs
Pinze ossivore
Pinzas gubias
Pincas gouges

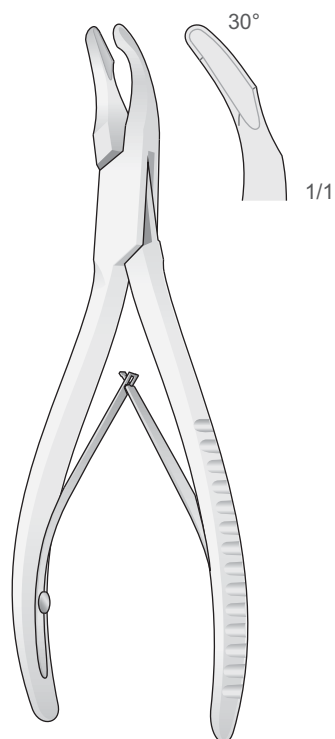

CLEVELAND
FO-231 140 mm
FO-232 170 mm

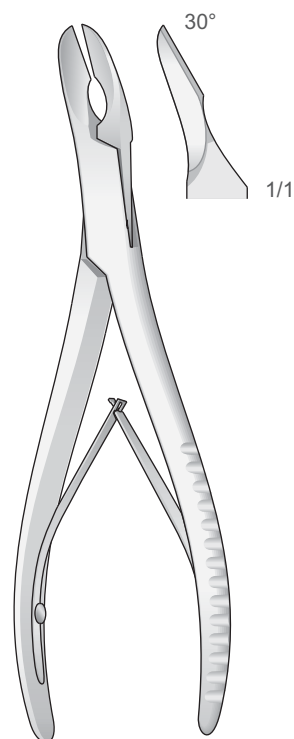

CLEVELAND
FO-233 150 mm
FO-234 170 mm

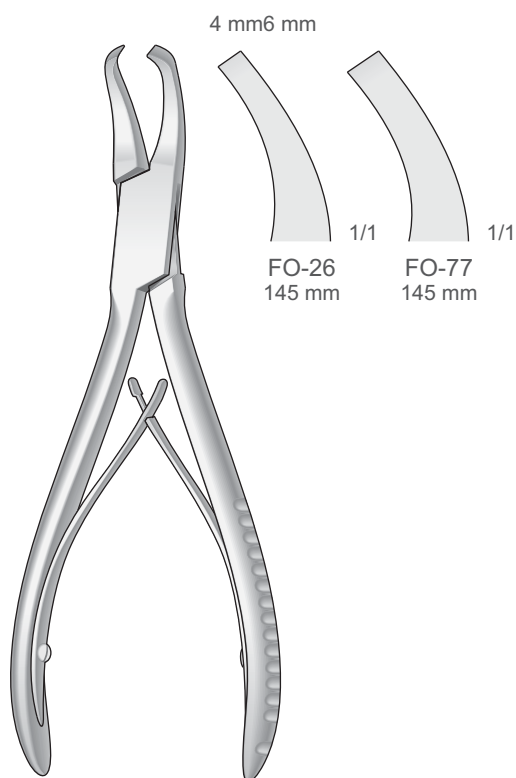

GARDNER
FO-26/FO-77
145 mm

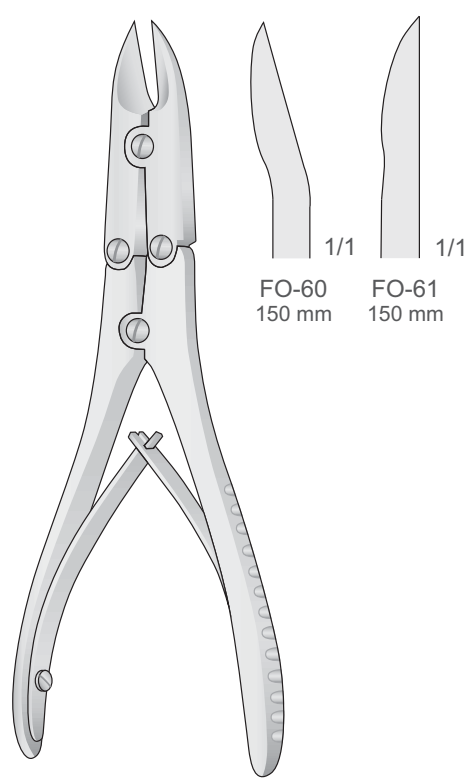

BÖHLER
FO-60/FO-61
150 mm

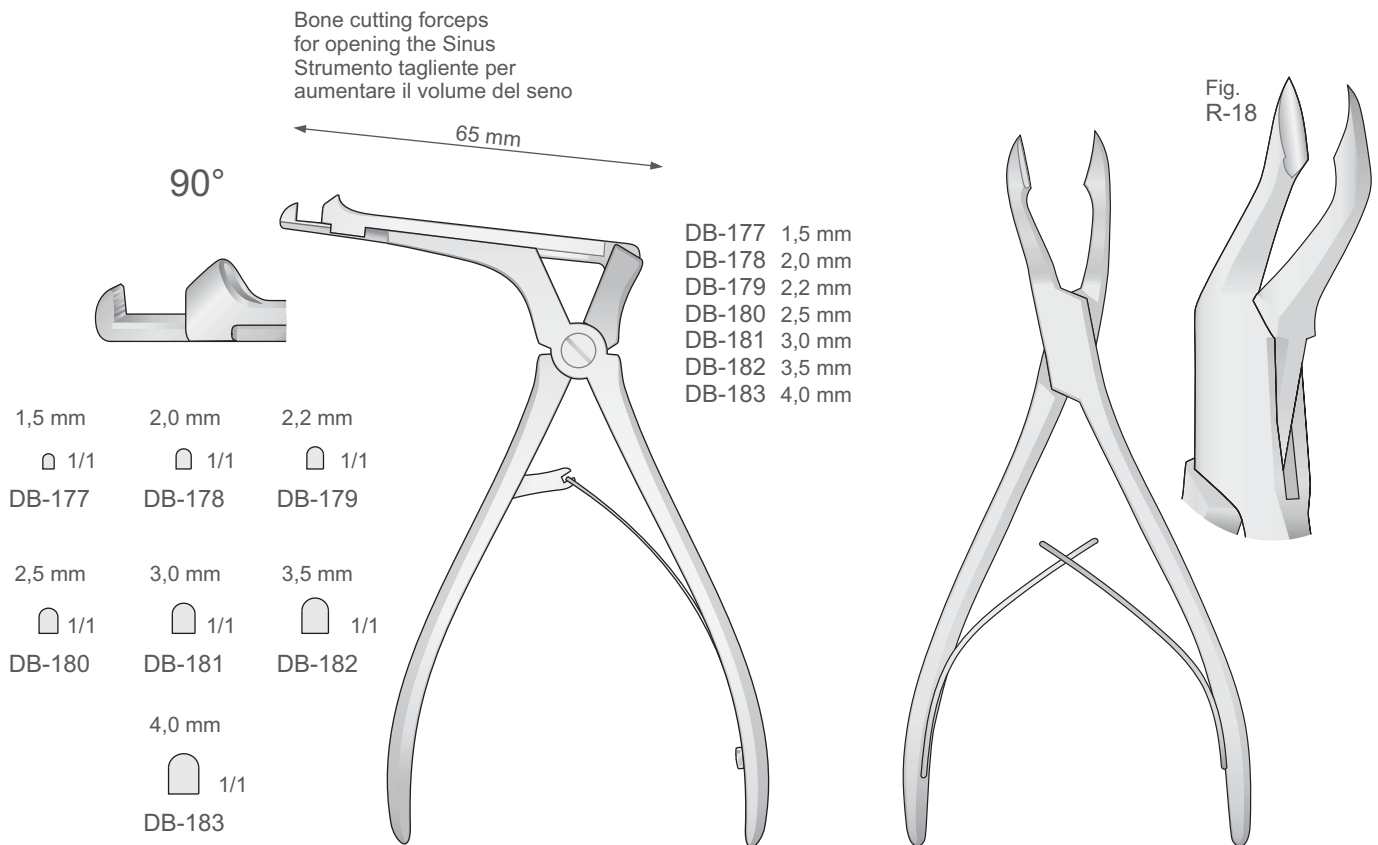
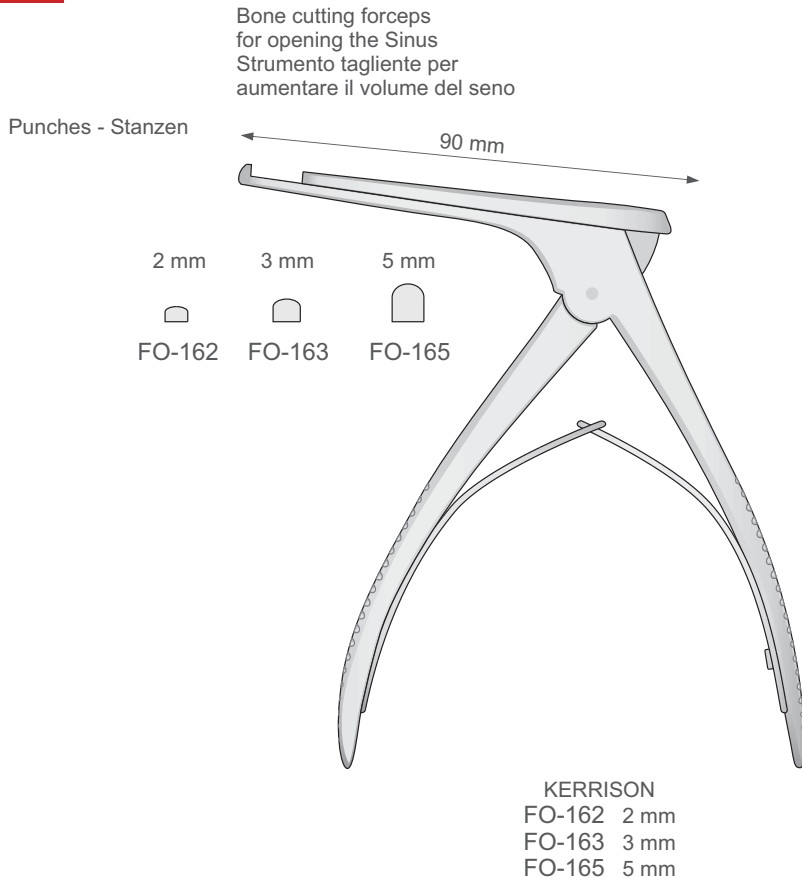

CITELLI
DB-177/DB-183

FO-33
175 mm



11

Periodontology
Parodontologie
Parodontie
Periodoncia
Parodontologia

Diagnosis
Diagnose
Diagnostic
Diagnóstico
Diagnosi

Dental Restoration
Restaurative Zahnheilkunde
Odontologie conservatrice
Odontología conservadora
Odontoiatria conservativa



Zahnsonden
Explorers - Sickle Probes
Esploratori - Sonde falce
Sondas exploradoras
Sondes exploratrices

11

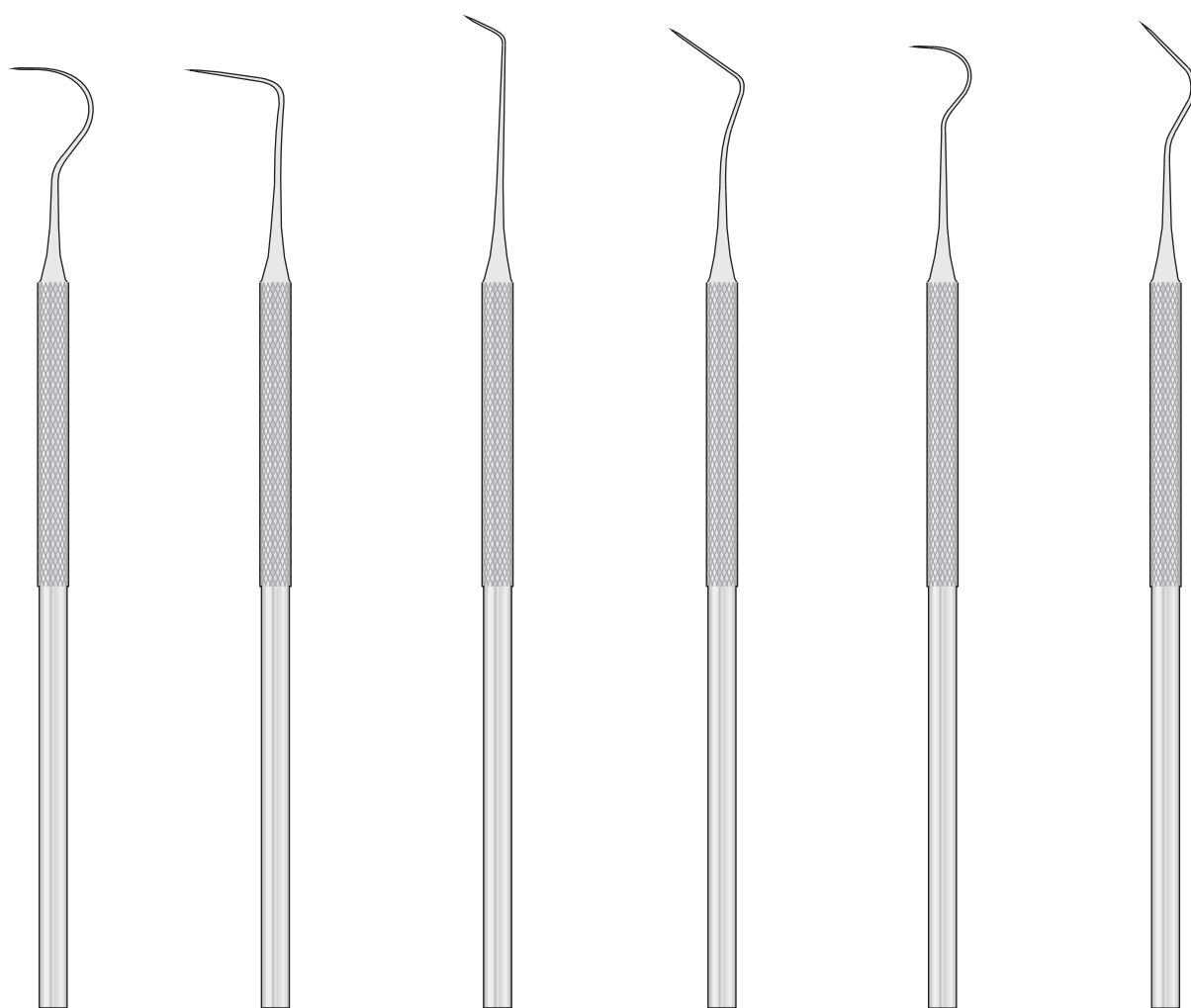

SO-1
Fig. 23

SO-2
Fig. 11

SO-3
Fig. 6

SO-4
Fig. 9

SO-5
Fig. 2

SO-6
Fig. 10



SO-7
Fig. 12



SO-8
Fig. 6A



SO-9
Fig. 8A

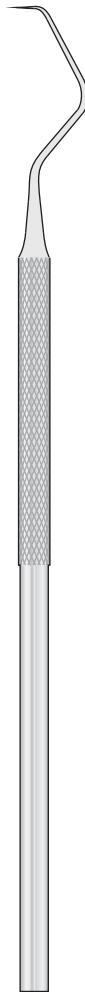

SO-10
Fig. 17A



SO-11
Fig. 3A



SO-12
Fig. 3



Parodontometer
Periodontal Probes
Sonde parodontali
Sondas parodontales
Sondes parodontales

Do not sterilizing with ultra sound - Not Metal brushes
Non sterilizzare in ultrasuoni - No spazzola metallica

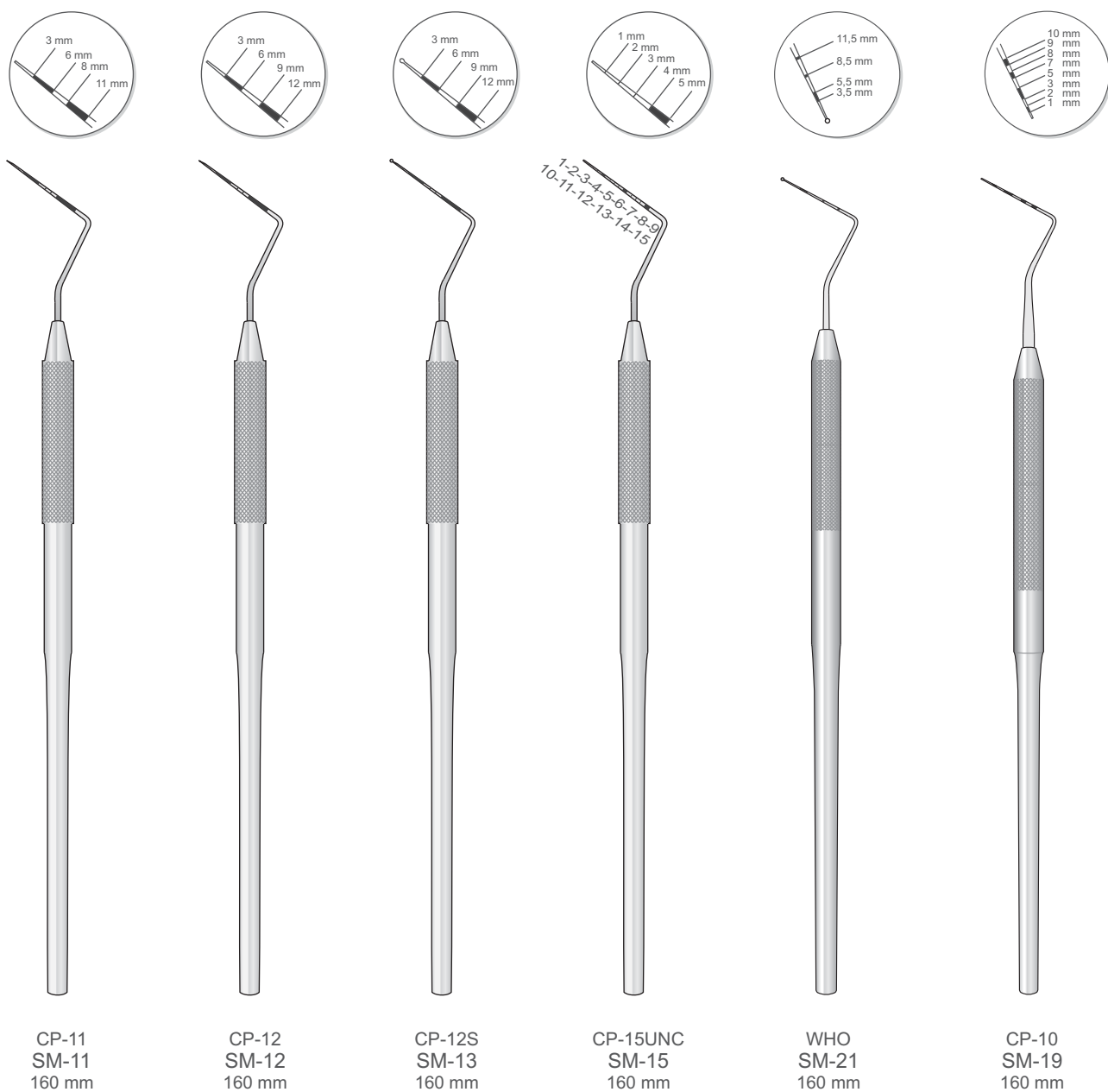

Double-ended Explorer
Doppelendiger Zahnsonden
Sonde exploratrice double
Sonda exploradora doble
Sonda falce doppia



11/12 ODU
SO-20
165 mm

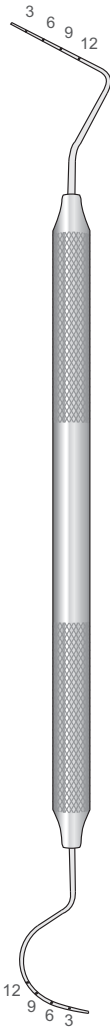

UT3/4 CATTONI
SM-20
165 mm



2QN NABERS
SM-22
175 mm

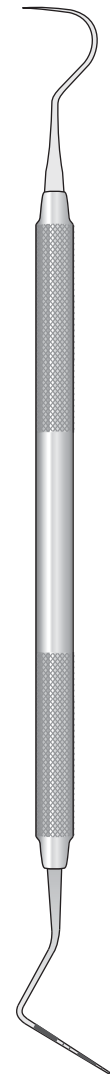
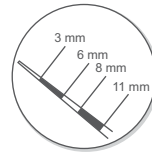

23 CP-11
EX-11

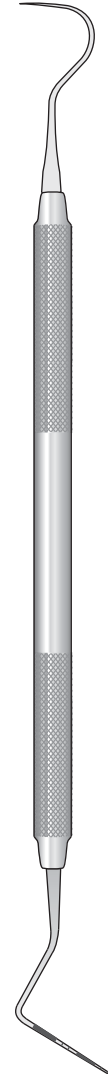
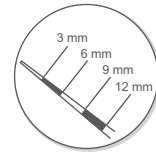

23 CP-12
EX-12



Parodontometer
Periodontal Probes
Sonde parodontali
Sondas parodontales
Sondes parodontales

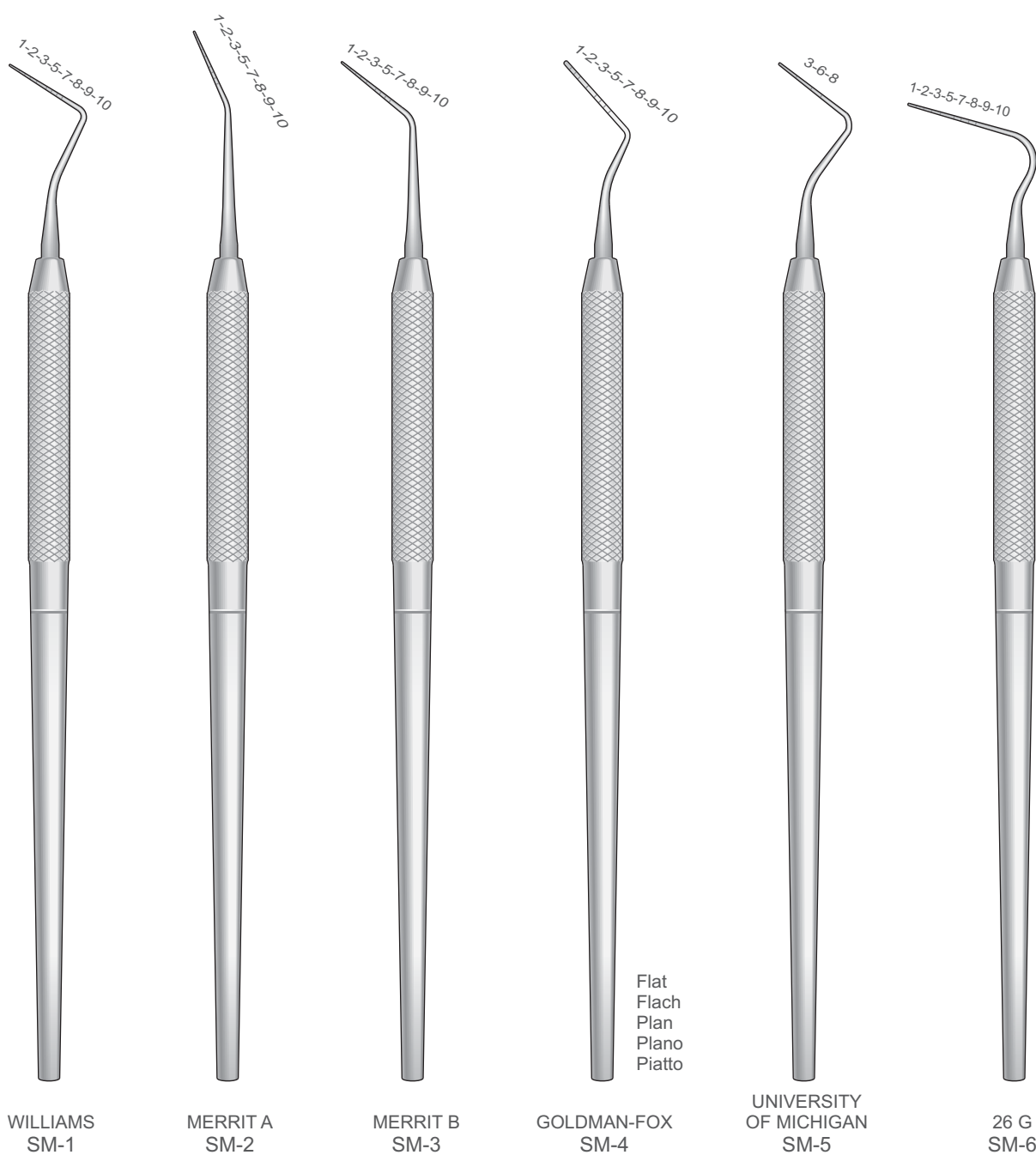

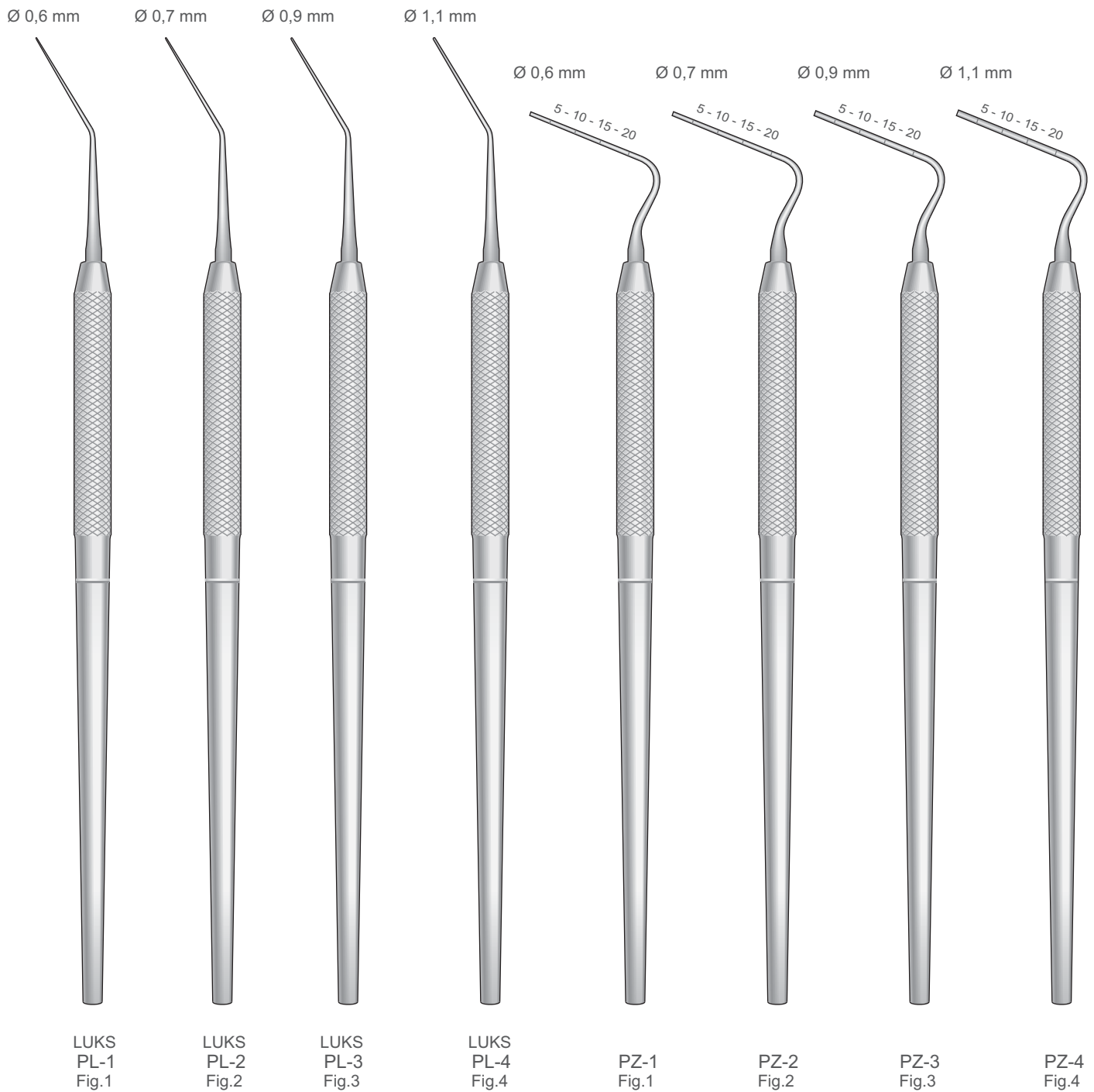



Spreaders

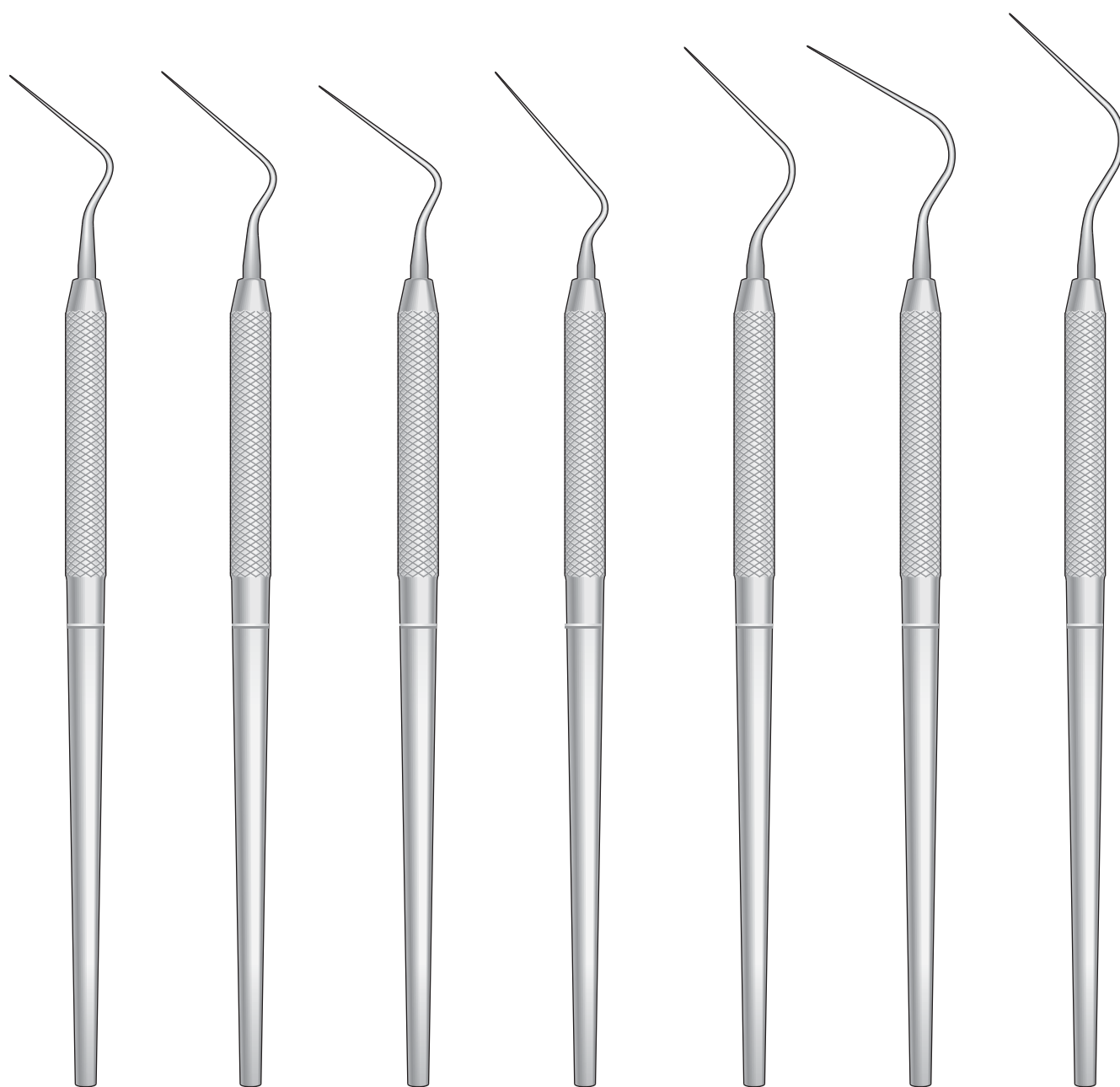

SP-1
Fig.1S

SP-2
Fig.2S

SP-3
Fig.D11

SP-4
Fig.MA57

SP-5
Fig.0

SP-6
Fig.00

SP-7
Fig.3

Tamponstopfer
Gauze Packers
Porta tamponi
Portatampones
Porte tampons

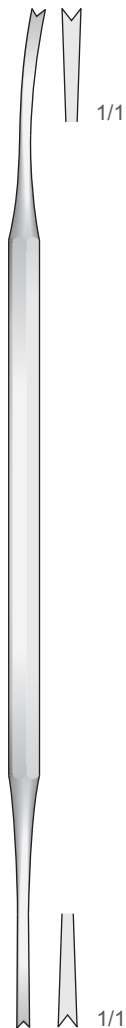

LUNIATSCHEK
PF-6
170 mm



UNIVERSAL
PF-40
140 mm

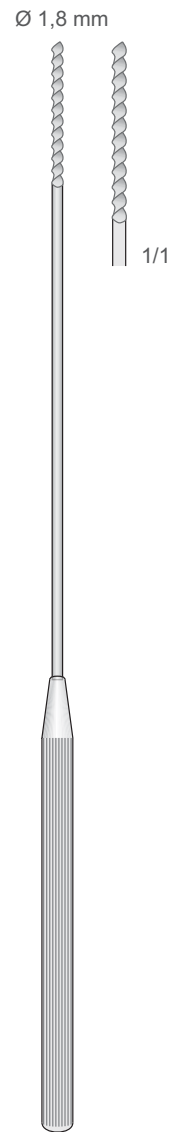

UNIVERSAL
PF-41
180 mm



Mundspiegel und Griffe
Mirrors and handles
Specchietti e manici
Espejos y mangos
Miroirs et manches

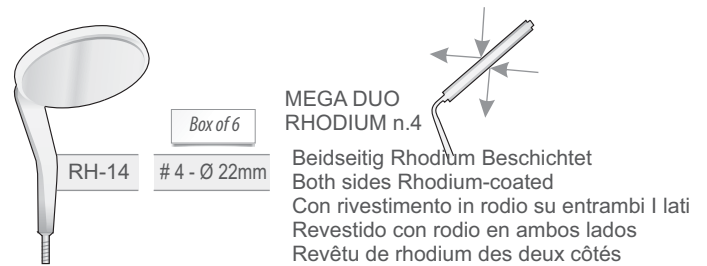
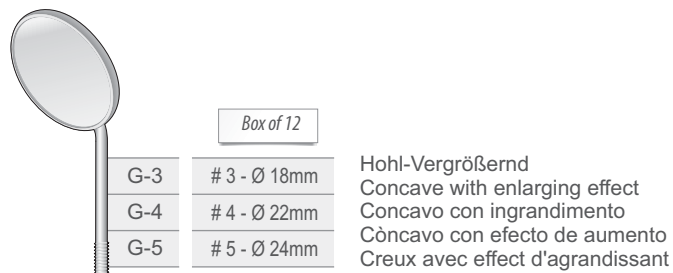
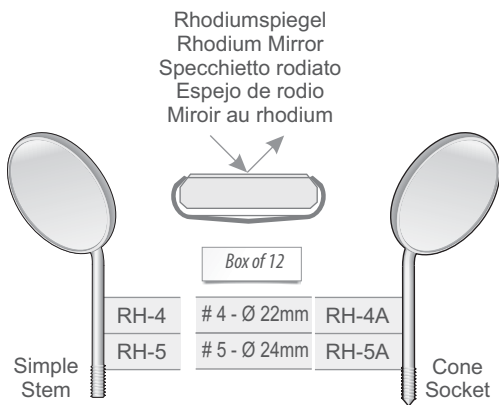
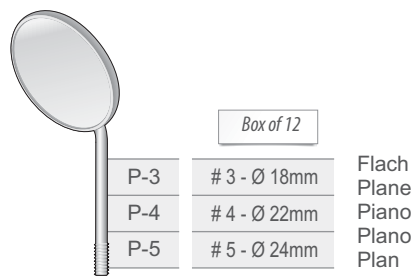

Massiv - Solid
Pieno - Sólido - Solide

Hohl - Hollow
Vuoto - Hueco - Creux

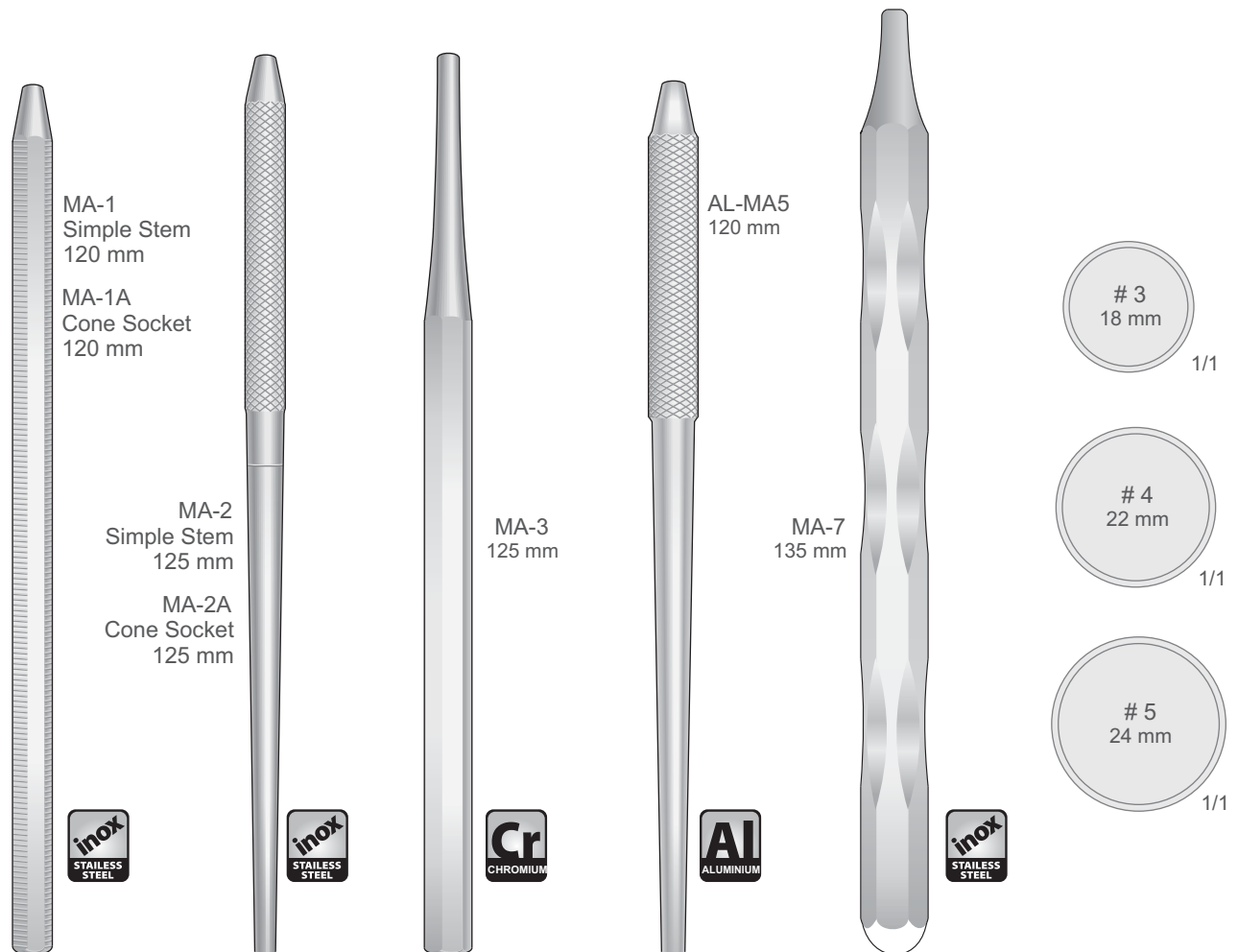

Spiegeldurchmesser - Diameter of mirrors
Diametro dello specchio - Diamètre des miroirs
Diámetro de los espejos

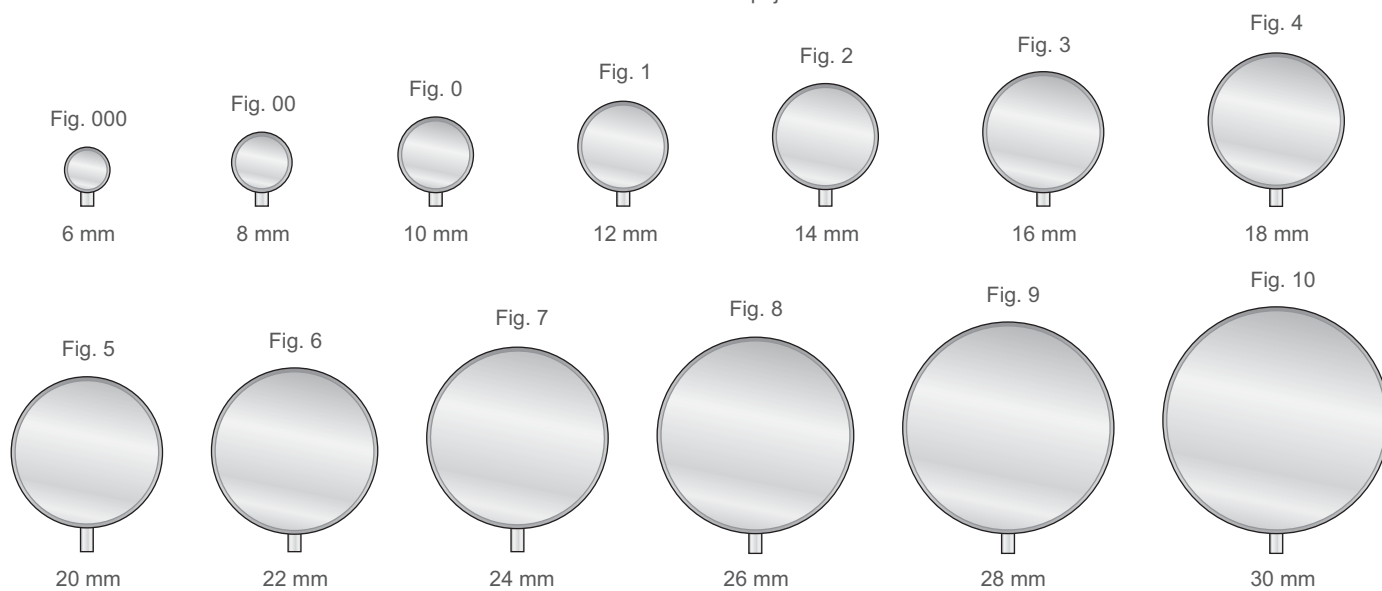

Inox

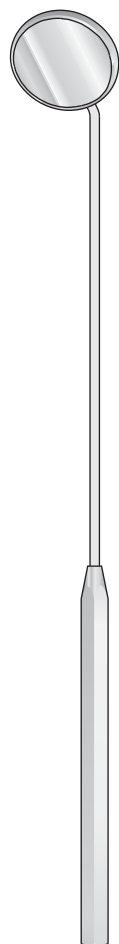

Kehlkopfspiegel mit
Sechskantgriff
Laryngeal mirrors
with hexagonal handle
Specchietto laringeo
con manico esagonale
Espejo laringeo
con mango hexagonal
Miroirs laryngiens
avec manche hexagonal

- G-8 Fig. 00
- G-10 Fig. 0
- G-12 Fig. 1
- G-14 Fig. 2
- G-16 Fig. 3
- G-18 Fig. 4
- G-20 Fig. 5
- G-22 Fig. 6
- G-24 Fig. 7
- G-26 Fig. 8
- G-28 Fig. 9
- G-30 Fig. 10

G-8/G-30
180 mm

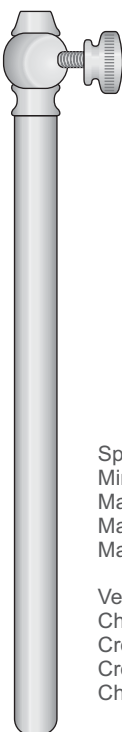

Spiegelgriff
Mirrors handle
Manico per specchietti
Mango para espejos
Manche à miroir

Verchromt
Chromium
Cromato
Cromado
Chromé

MA-6
120 mm

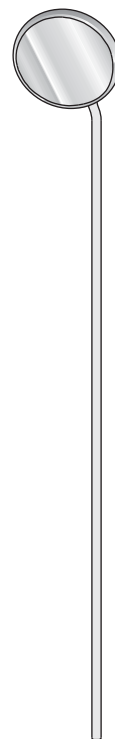

Kehlkopfspiegel
Laryngeal mirrors
Specchietto laringeo
Espejos laringeos
Miroirs laryngiens

- P-000 Fig. 000
- P-00 Fig. 00
- P-0 Fig. 0
- P-01 Fig. 1
- P-02 Fig. 2
- P-03 Fig. 3
- P-04 Fig. 4
- P-05 Fig. 5
- P-06 Fig. 6

P-000/P-06
120 mm



Dental-Spritzen
Dental Syringes
Siringhe dentali
Jeringas dentales
Seringues dentaires

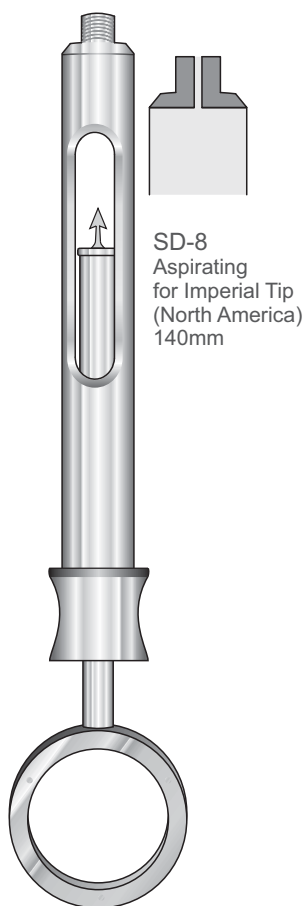

SD-8
Aspirating
for Imperial Tip
(North America)
140mm

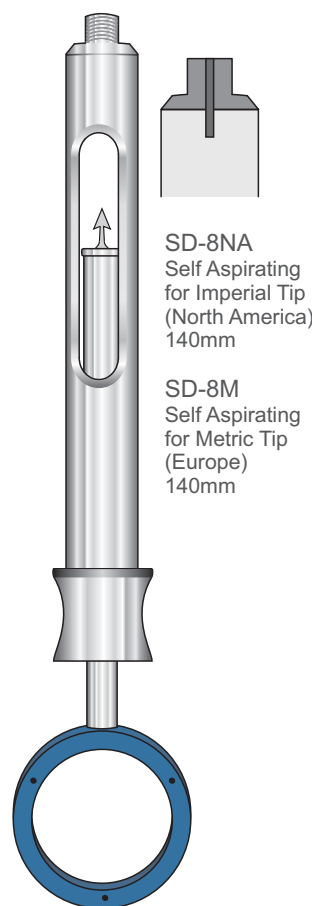

SD-8NA
Self Aspirating
for Imperial Tip
(North America)
140mm

SD-8M
Self Aspirating
for Metric Tip
(Europe)
140mm

Spritzen zur lokalen Interligamentär-Anästhesie
Syringes for Intraligamental anaesthesia
Siringa per anestesia intraligamentare
Jeringa intraligamentaria para anestesia
Seringues pour anesthésies intraligamentaires

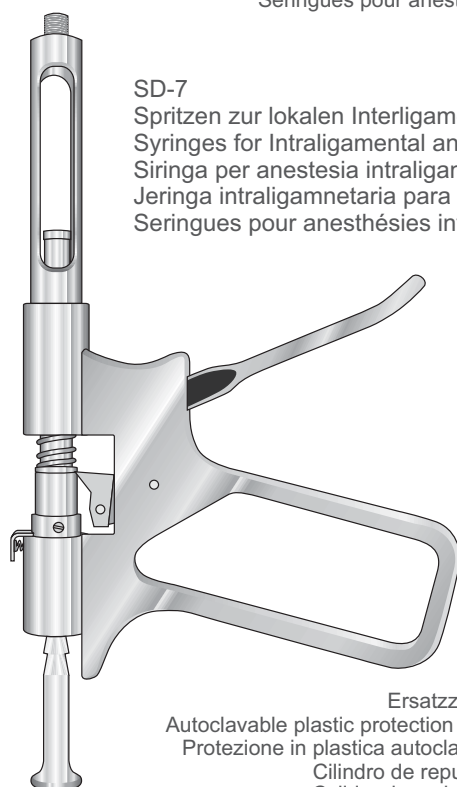

SD-7
Spritzen zur lokalen Interligamentär-Anästhesie
Syringes for Intraligamental anaesthesia
Siringa per anestesia intraligamentare
Jeringa intraligamentaria para anestesia
Seringues pour anesthésies intraligamentaires

SD-7R
Ersatzzylinder für SD-7
Autoclavable plastic protection sleeve for SD-7
Protezione in plastica autoclavabile per SD-7
Cilindro de repuesto para SD-7
Cylindre de rechange pour SD-7

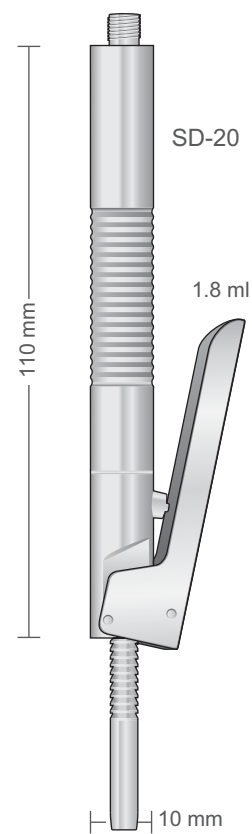

SD-20

1.8 ml

110 mm

10 mm

Zylinder-Ampullen Spritzen
Cartridge Syringes
Siringhe per tubofiale
Jeringas de ampollas
Seringues d'ampoules

Aufsatz
Spare cap only
Adattatore solo
Adaptador suelto
Embout seul

Aufsatz
Spare cap only
Adattatore solo
Adaptador suelto
Embout seul

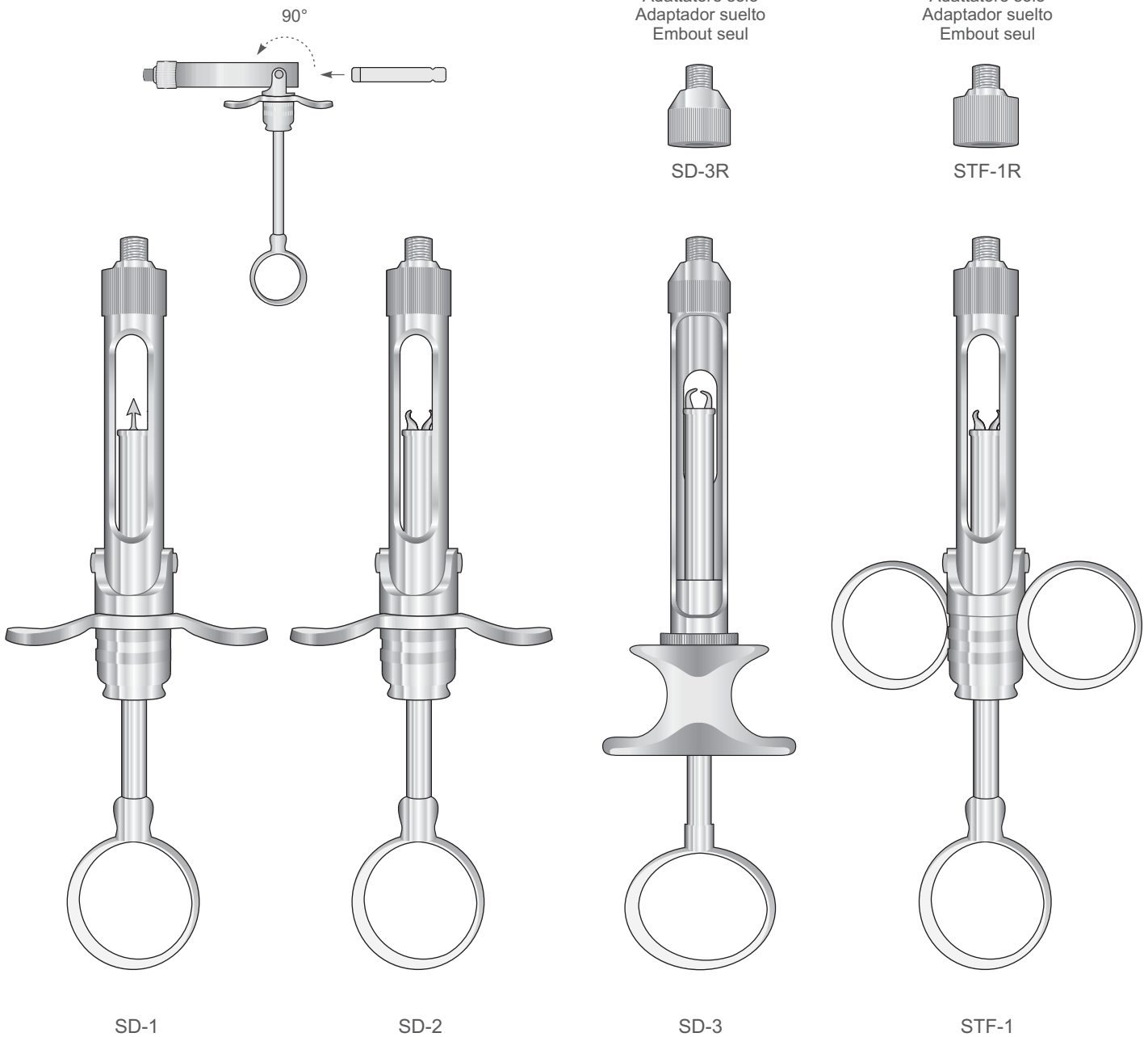



Küretten
Curettes
Curette
Curetas
Curettes



GRACEY
CU-1/2



GRACEY
CU-3/4



GRACEY
CU-5/6



GRACEY
CU-7/8



GRACEY
CU-9/10



GRACEY
CU-11/12



GRACEY
CU-13/14

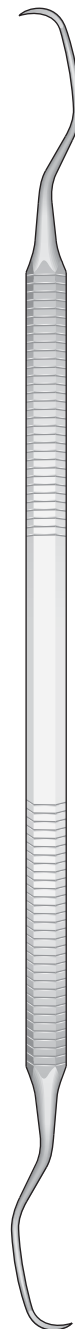

LANGER Fig.1/2
COL-1/2



LANGER Fig.3/4
COL-3/4



COLUMBIA
COL-2RL



COLUMBIA
COL-4RL



COLUMBIA
COL-13/14



Hollow
Hohl
Creux
Hueco
Vuoto



USG-1/2ET
Gracey
Curette 1/2ET



USG-3/4ET
Gracey
Curette 3/4ET



USG-5/6ET
Gracey
Curette 5/6ET



USG-7/8ET
Gracey
Curette 7/8ET



USG-9/10ET
Gracey
Curette 9/10ET



USG-11/12ET
Gracey
Curette 11/12ET



USG-13/14ET
Gracey
Curette 13/14ET



USG-15/16ET
Gracey
Curette 15/16ET

Scalers and Curettes Extra Thin
Balanced and ergonomic for great tactile working ability.
Extra light hollow handle for optimum comfort (feather weight / round Ø 9 mm).
Maintains long sharp edges.



Scaler und Küretten
Scalers and Curettes
Scaler e Curette
Raspadores y Curetas
Détartreurs et Curettes



USG-1/2
Gracey
Curette 1/2



USG-3/4
Gracey
Curette 3/4



USG-5/6
Gracey
Curette 5/6



USG-7/8
Gracey
Curette 7/8



USG-9/10
Gracey
Curette 9/10



USG-11/12
Gracey
Curette 11/12



USG-13/14
Gracey
Curette 13/14



USG-1/2S
Gracey
Curette 1/2S



USG-3/4S
Gracey
Curette 3/4S



USG-5/6S
Gracey
Curette 5/6S

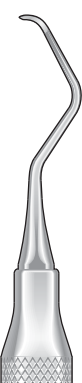

USG-7/8S
Gracey
Curette 7/8S



USG-9/10S
Gracey
Curette 9/10S



USG-11/12S
Gracey
Curette 11/12S



USG-13/14S
Gracey
Curette 13/14S

Scalers and Curettes

Balanced and ergonomic for great tactile working ability.

Extra light hollow handle for optimum comfort (feather weight / round Ø 9 mm).

Maintains long sharp edges.



Hollow
Hohl
Creux
Hueco
Vuoto



Ø 9 mm



USG-1/2L
Gracey
Curette 1/2L



USG-3/4L
Gracey
Curette 3/4L



USG-5/6L
Gracey
Curette 5/6L



USG-7/8L
Gracey
Curette 7/8L



USG-9/10L
Gracey
Curette 9/10L



USG-11/12L
Gracey
Curette 11/12L



USG-13/14L
Gracey
Curette 13/14L



USG-15/16
Gracey
Curette 15/16



USG-17/18S
Gracey
Curette 17/18S



USS-KRA1
Kramer
Curette 1



USS-KRA3
Kramer
Curette 3



USG-KN1/26
Kramer-Nevins
Chisels 1/2



USS-MC11/12
McCall
Scaler 11/12



USS-MC13/14
McCall
Curette 13/14



USS-MC13/14S
McCall
Curette 13S/14S



USS-MC17/18S
McCall
Curette 17S/18S



USC-2RL
Columbia
Curette 2RL



USC-4RL
Columbia
Curette 4RL



USC-13/14
Columbia
Curette 13/14



USS-5/6LAN
Langer
Curette 5/6



Scaler und Küretten
Scalers and Curettes
Scaler e Curette
Raspadores y Curetas
Détartreurs et Curettes



Hollow
Hohl
Creux
Hueco
Vuoto



Ø 9 mm



USS-NV0
Scaler
Nv0



USS-NV11/12
Scaler
NV11/12



USS-NV13/14
Scaler
NV13/14



USS-T2/3
Taylor
Scaler 2/3



USS-204S
Scaler
204S



USS-H6/7
Towner
Scaler
H6/H7



USS-15/33
Towner
Scaler
U15/J33



USS-5/33
Towner
Scaler
H5/J33



USS-15/30
Towner
Scaler
U15/J30



USS-J14/15
Jaquette
Scaler
J14/15



Scalers and Curettes
Balanced and ergonomic for great tactile working ability.
Extra light hollow handle for optimum comfort (feather weight / round Ø 9 mm).
Maintains long sharp edges.



Ø 8 mm

Hollow
Hohl
Creux
Hueco
Vuoto



Designed for removing calculus on implants surfaces.
Gold coloured handle with a titanium coating for easy identification purposes
so they won't be mixed up with standard stainless instruments.



T-USG-1/2
Gracey
Curette 1/2

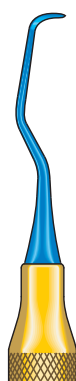

T-USG-5/6
Gracey
Curette 5/6



T-USG-7/8
Gracey
Curette 7/8

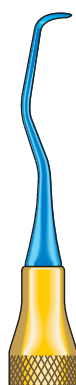

T-USG-11/12
Gracey
Curette 11/12



T-USG-13/14
Gracey
Curette 13/14

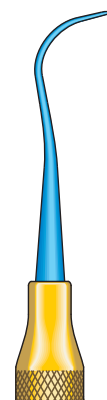

T-USS-YG7/8
Younger-Good
Curette YG 7/8



T-USS-B5/6
Barnhart
Curette 5/6

Titanium Scalers and Curettes
Balanced and ergonomic for great tactile working ability.
Extra light hollow handle for optimum comfort (feather weight / round Ø 9 mm).
Maintains long sharp edges.

⚠ Use a dedicated sharpening stone for Titanium Scalers & Curettes. / Do not sterilize with non titanium instruments.



Küretten - Feilen
Curettes - Files
Curette - Lime
Curetasc - Lima
Curettes - Limes

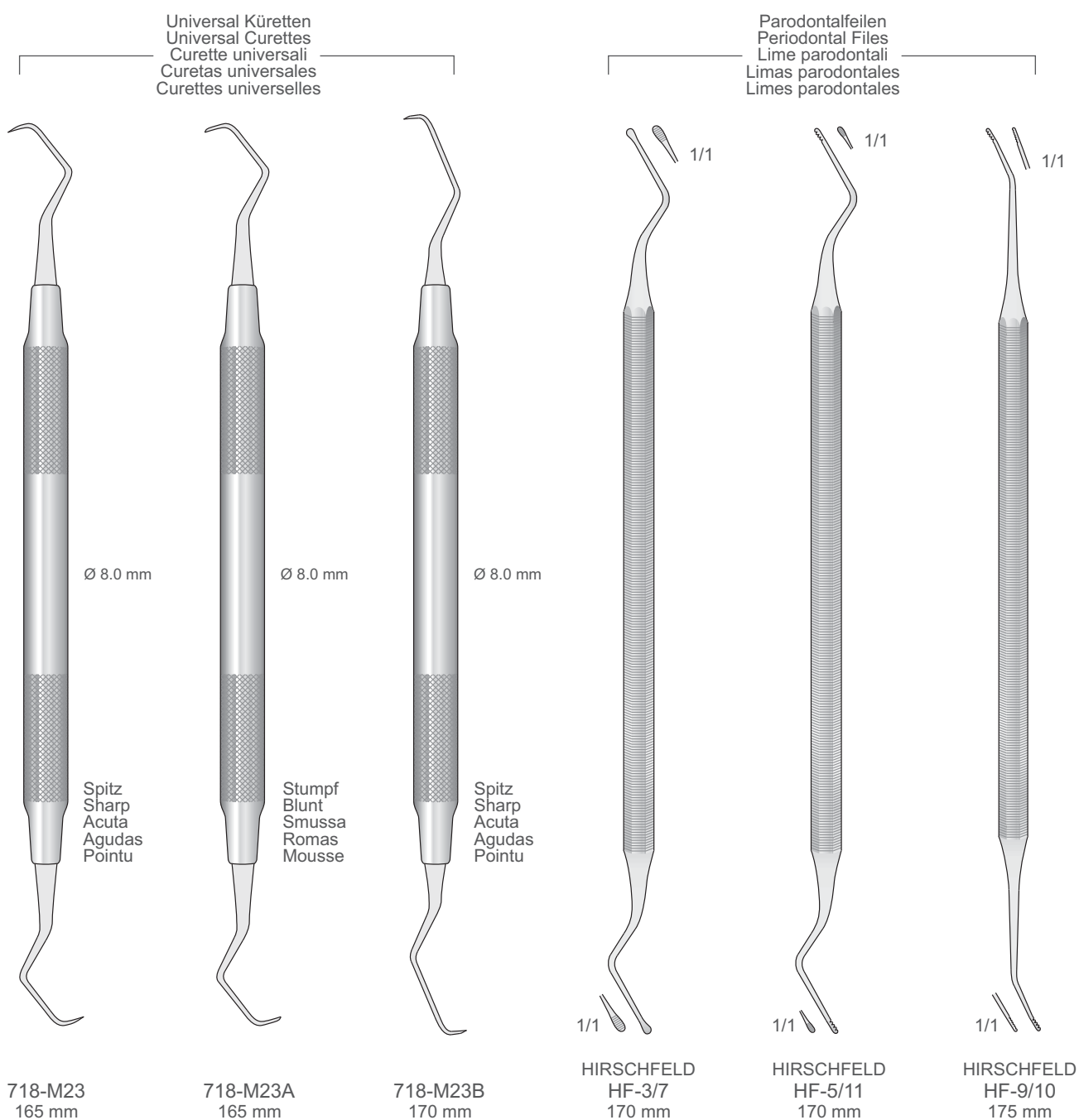

Scalers

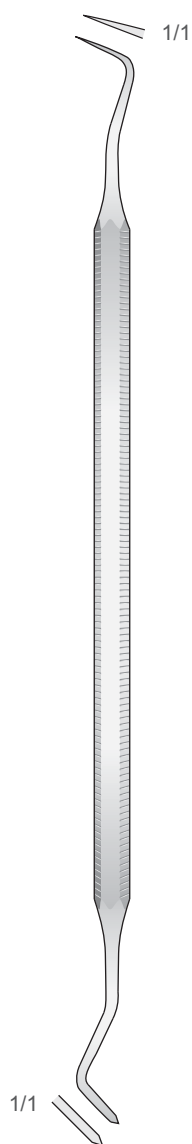

LANGE
PF-9
160 mm

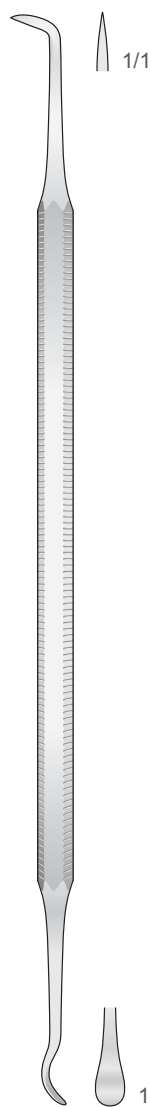

MITCHEL
AT-12
170 mm



AT-1



AT-2R



AT-2L



AT-6



Amalgampistole für retrograde
Amalgam gun for retrograde
Siringhe portamalgame retrogradi
Portaamalgama para retrógradas
Porte-amalgame pour rétrogrades

Nach oben Gebogen - Curved up
Curva in avanti - Curvas hacia arriba
Courbes vers le haut
Ø 0,9 mm

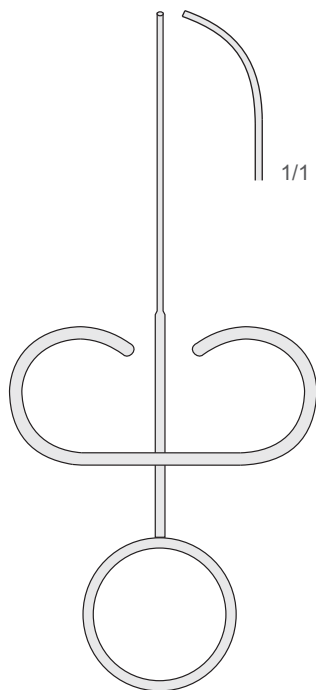

SS-51
130 mm

Seitwärts Gebogen - Curved to side
Curva sul lato - Curvas laterales
Courbes latérales
Ø 0,9 mm

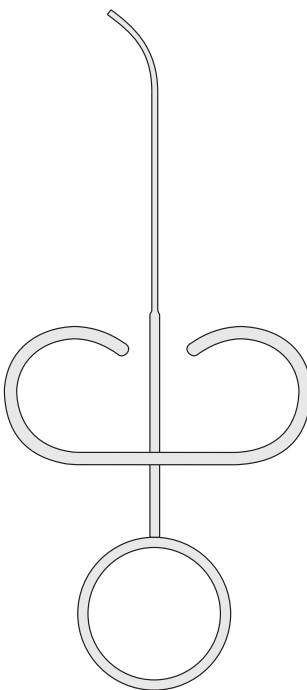

SS-55
130 mm

Gerade - Straight
Diritta - Rectas
Droites
Ø 1,2 mm

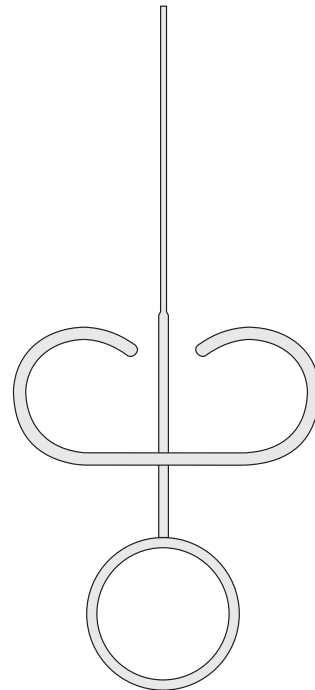

SS-54
130 mm

Seitwärts Gebogen - Curved to side
Curva sul lato - Curvas laterales
Courbes latérales
Ø 1,2 mm

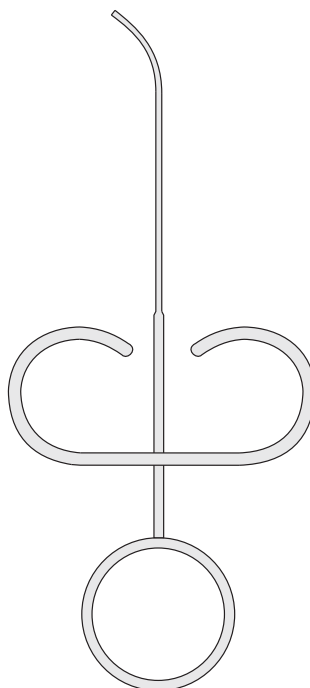

SS-56
130 mm

Nach oben Gebogen - Curved up
Curva in avanti - Curva hacia arriba
Courbes vers le haut
Ø 1,2 mm

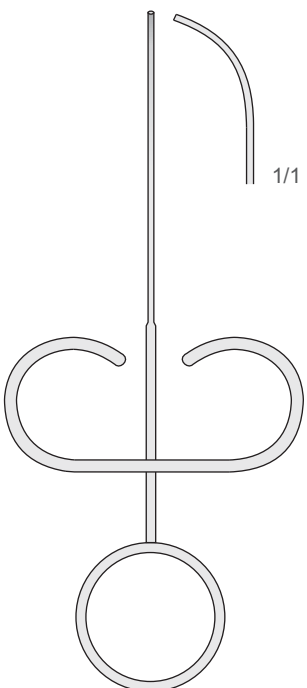

SS-58
130 mm

Seitwärts Gebogen - Curved to side
Curva sul lato - Curvas laterales
Courbes latérales
Ø 1,8 mm

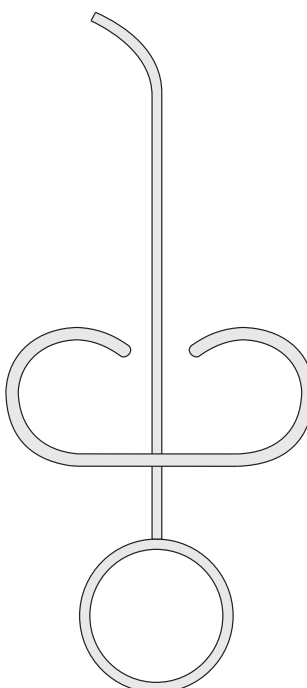

SS-50
130 mm

Nach oben Gebogen - Curved up
Curva in avanti - Curvas hacia arriba
Courbes vers le haut
Ø 1,8 mm

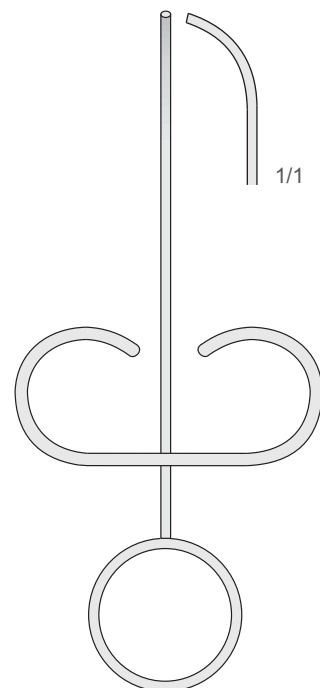

SS-52
130 mm

Amalgambecher
Amalgam Well
Mortajo per amalgama
Vaso para amalgama
Gobelet pour amalgame



SS-65
Ø 35 mm
h. 35 mm

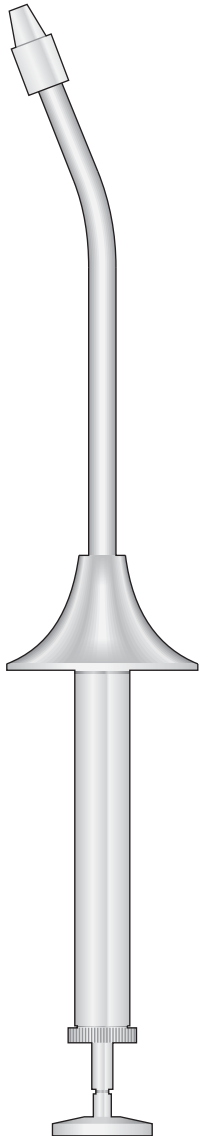

SS-15

Aus Metall
Metal tip
In metallo
De metal
En métal

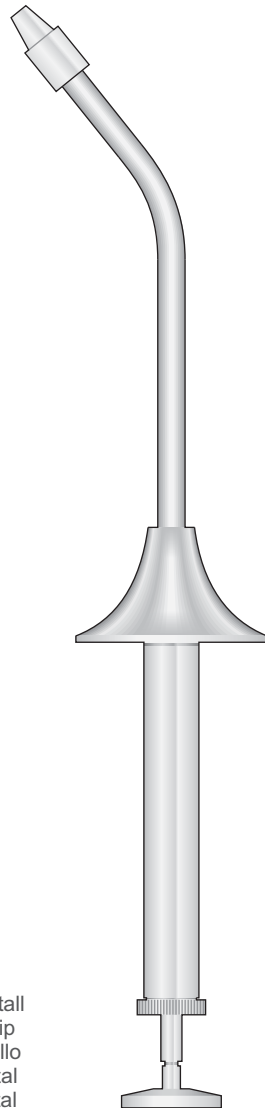

SS-16

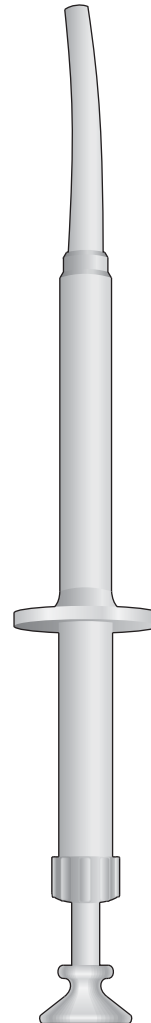

SS-41
170 mm

Autoclavable
Aus Kunststoff
Plastic tip
In plastica
De plàstico
En plastique

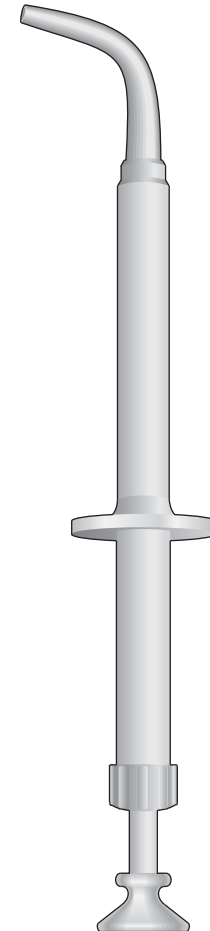

SS-42
160 mm



Kompositinstrumente
Composite Instruments
Strumenti per composito
Instrumentos para composites
Instruments pour composites



Fig. Fe1



FELT
OT-1

Fig. Fe2



FELT
OT-2

Fig. Fe3



FELT
OT-3

Fig. Fe4



FELT
OT-4

Fig. Fe5



FELT
OT-5

Fig. Fe6



FELT
OT-6

Fig. Go1



GOLDSTEIN
OT-7

Fig. Go2



GOLDSTEIN
OT-8

Fig. Go3



GOLDSTEIN
OT-9

Fig. Go4



GOLDSTEIN
OT-10

Ti
TITANIUM
Titanium-coated
Titan-beschichtet
Recouvrement en Titane
Recubrimiento de Titanio
Ricoperto in Titanio

Fig. CP1
1,5 mm

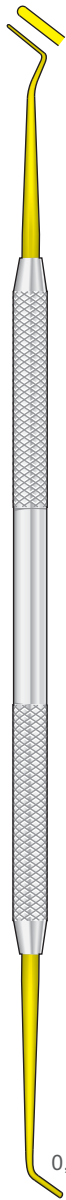

OT-11

Fig. CP2
2,0 mm



OT-12

Fig. CP3
2,0 mm



OT-13

Fig. CP4
2,5 mm



OT-14

Fig. CP5



OT-15

Fig. CP6



OT-16

0,7 mm

1,0 mm

2,0 mm

2,5 mm



Kompositinstrumente
Composite Instruments
Strumenti per composito
Instrumentos para composites
Instruments pour composites

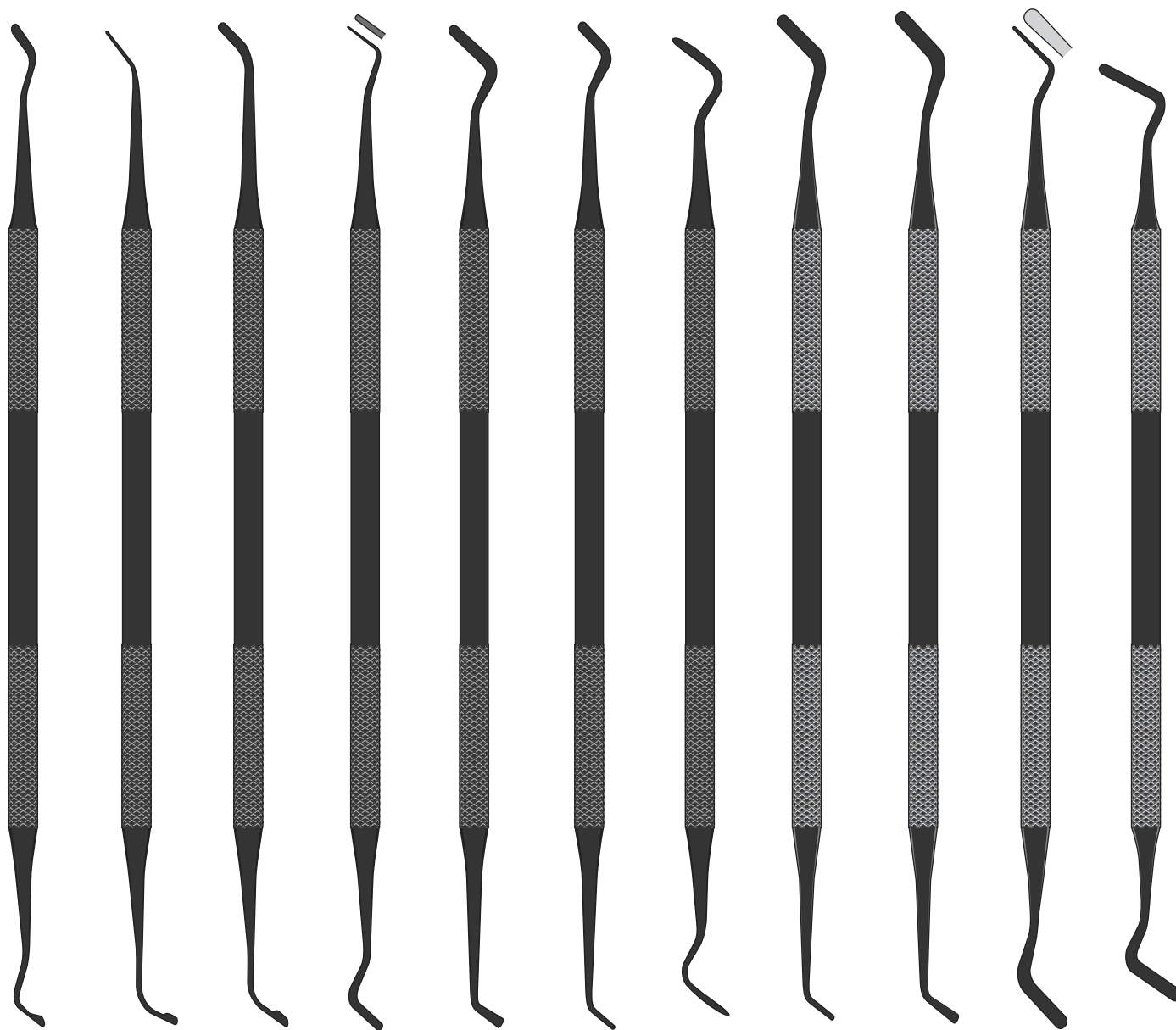

FELT
FE-1

FELT
FE-2

FELT
FE-3

FELT
FE-4

FELT
FE-5

FELT
FE-6

FELT
FE-4/5

GOLDSTEIN
GO-1

GOLDSTEIN
GO-2

GOLDSTEIN
GO-3

GOLDSTEIN
GO-4

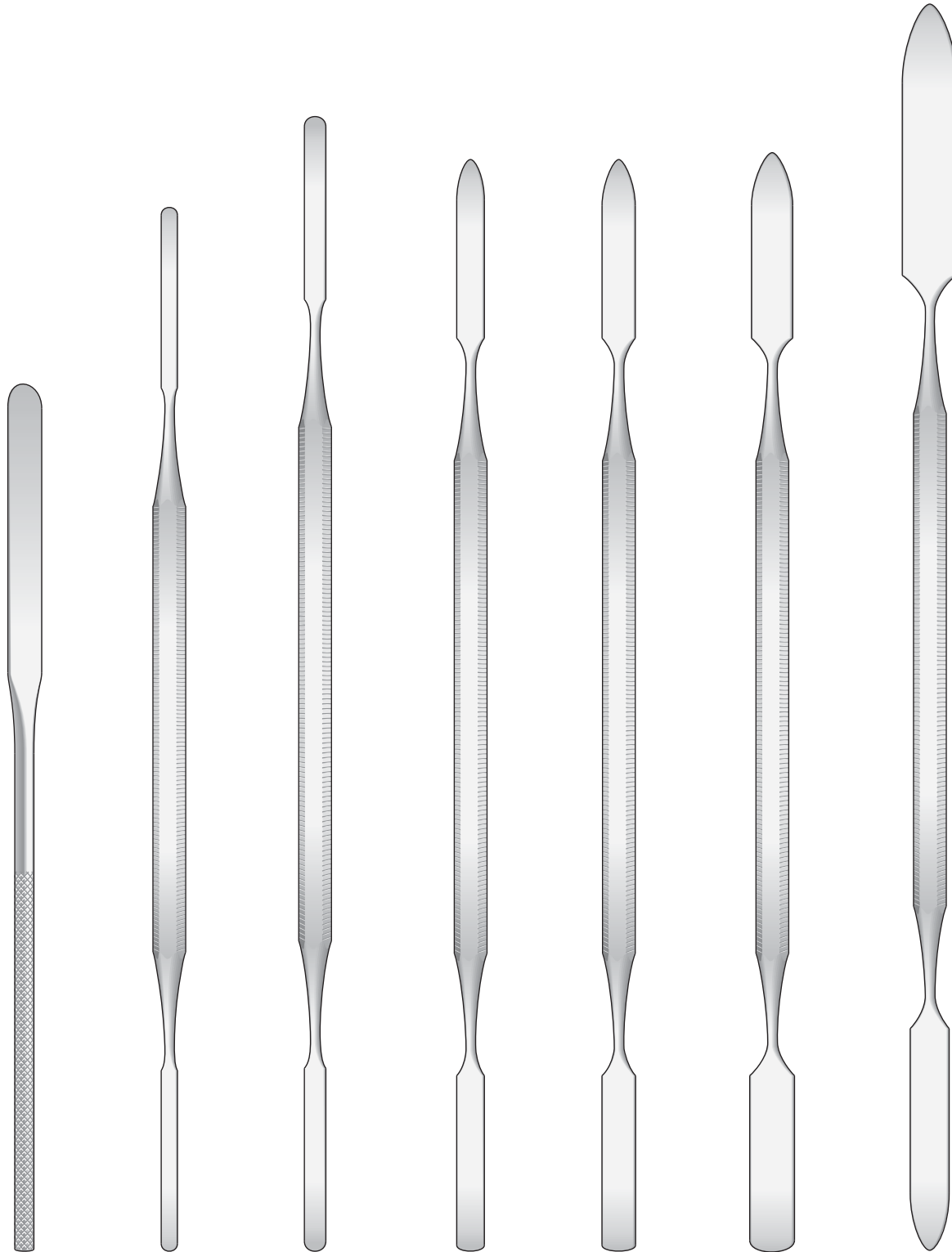

SR
140 mm

S-00
180 mm

S-0
185 mm

S-1
180 mm

S-2
180 mm

S-3
180 mm

S-4
200 mm



Füllungsinstrumente
Filling Instruments
Strumenti per otturazione
Instrumentos para obturación
Instruments pour obturation

Heidemann-Spateln
Heidemann Spatulas
Spatole Heidemann
Espátulas Heidemann
Spatules Heidemann

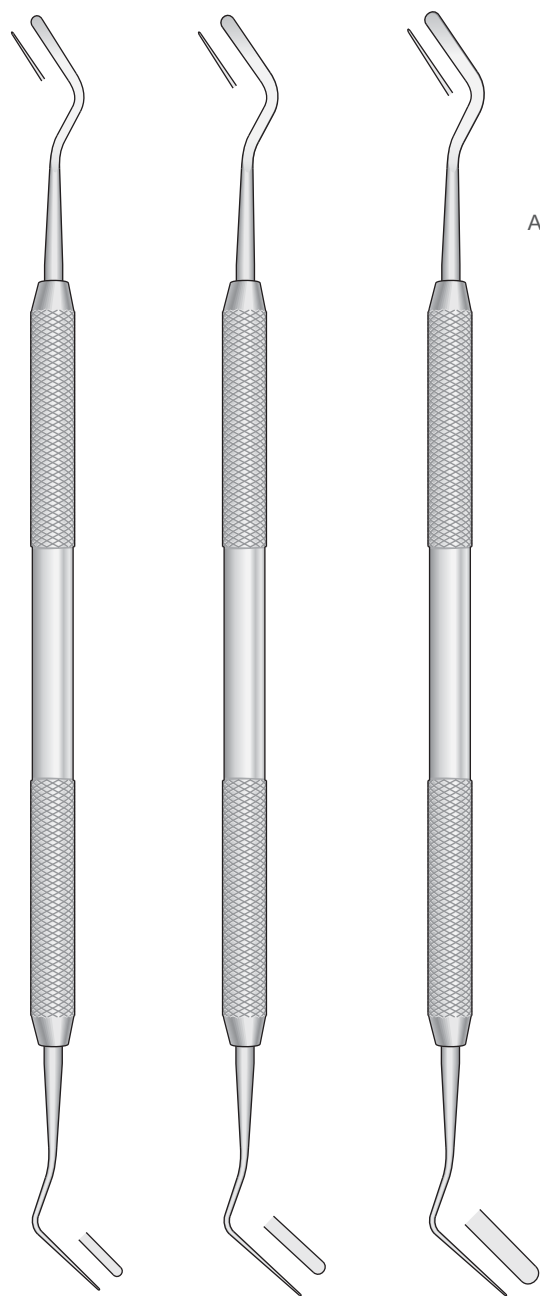

H-1
Fig. 1

H-2
Fig. 2

H-3
Fig. 3

Dycal Applikator
Placement Instrument
Aplicatore per sottofondo
Aplicadores de fondo
de cavidades
Applicateur de fond
de cavité



A-1
125 mm

Amalgam Instrumente
Amalgam Carvers
Strumenti per modellare l'amalgama
Instrumentos para modelar las obturaciones
Instruments à modeler l'amalgame

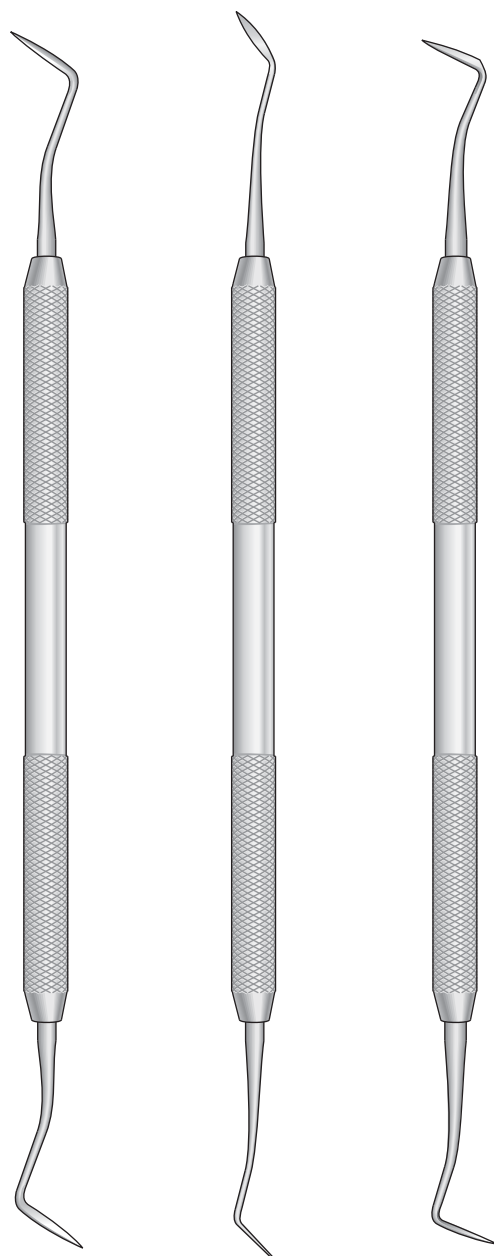

R-1
HOLLENBACH
1 - 165 mm

R-2
HOLLENBACH
1/2 - 165 mm

R-3
HOLLENBACH
3 - 165 mm

Instrument für Drahrückzug
Instrument for retractor wire
Strumento per filo retrattore
Instrumento para hilo separador
Instruments pour fil séparateur

Cleoids - Discoids

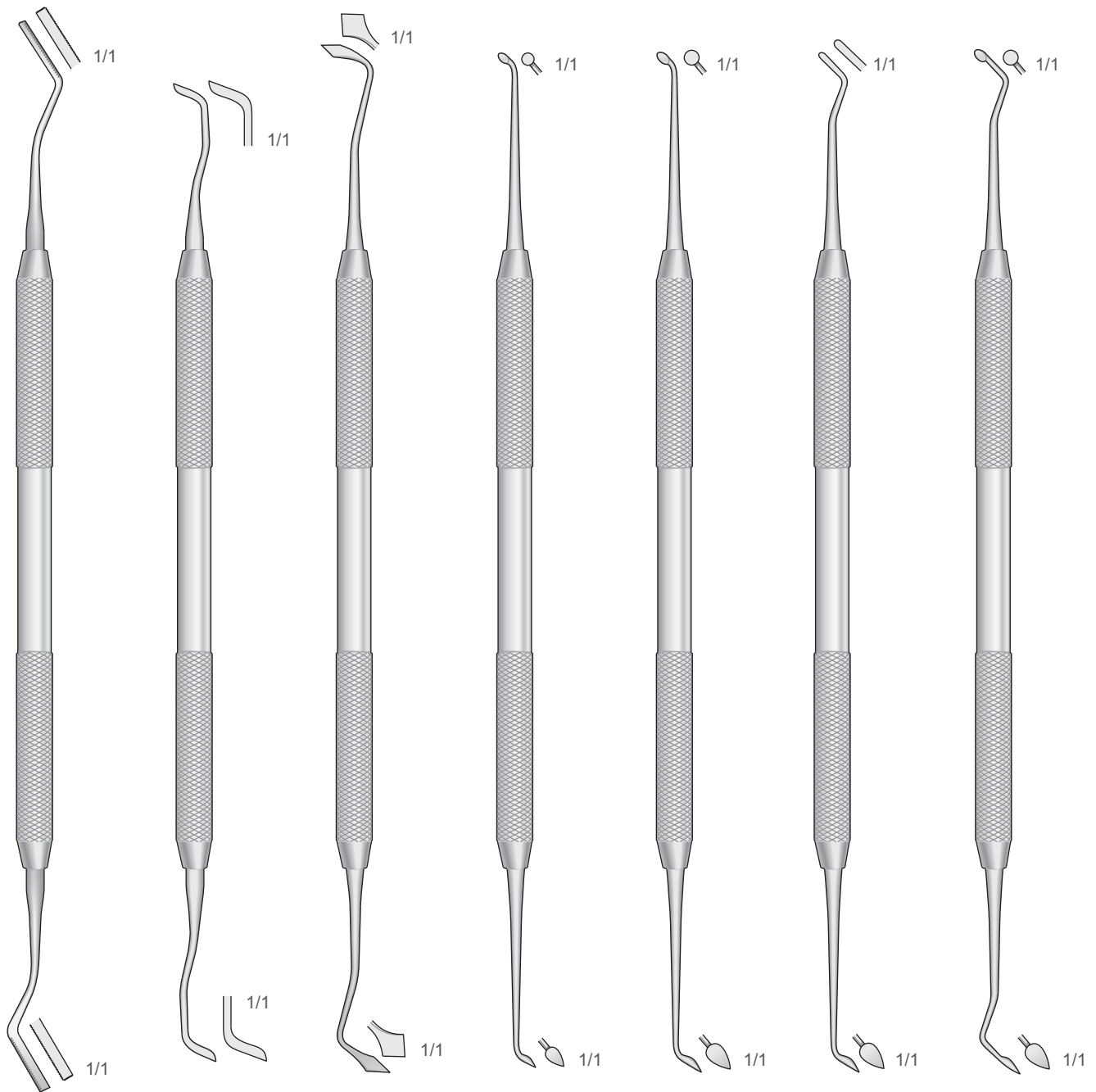

CV-11

USC-2
USC

F-2/3
FRAHM

CD-1
Fig. 1/2

CD-2
Fig. 4/5

CD-3
Fig. W.A.C.D.

CD-4
Fig. 3/6



Füllungsinstrumente
Filling Instruments
Strumenti per otturazione
Instrumentos para obturación
Instruments pour obturation

11

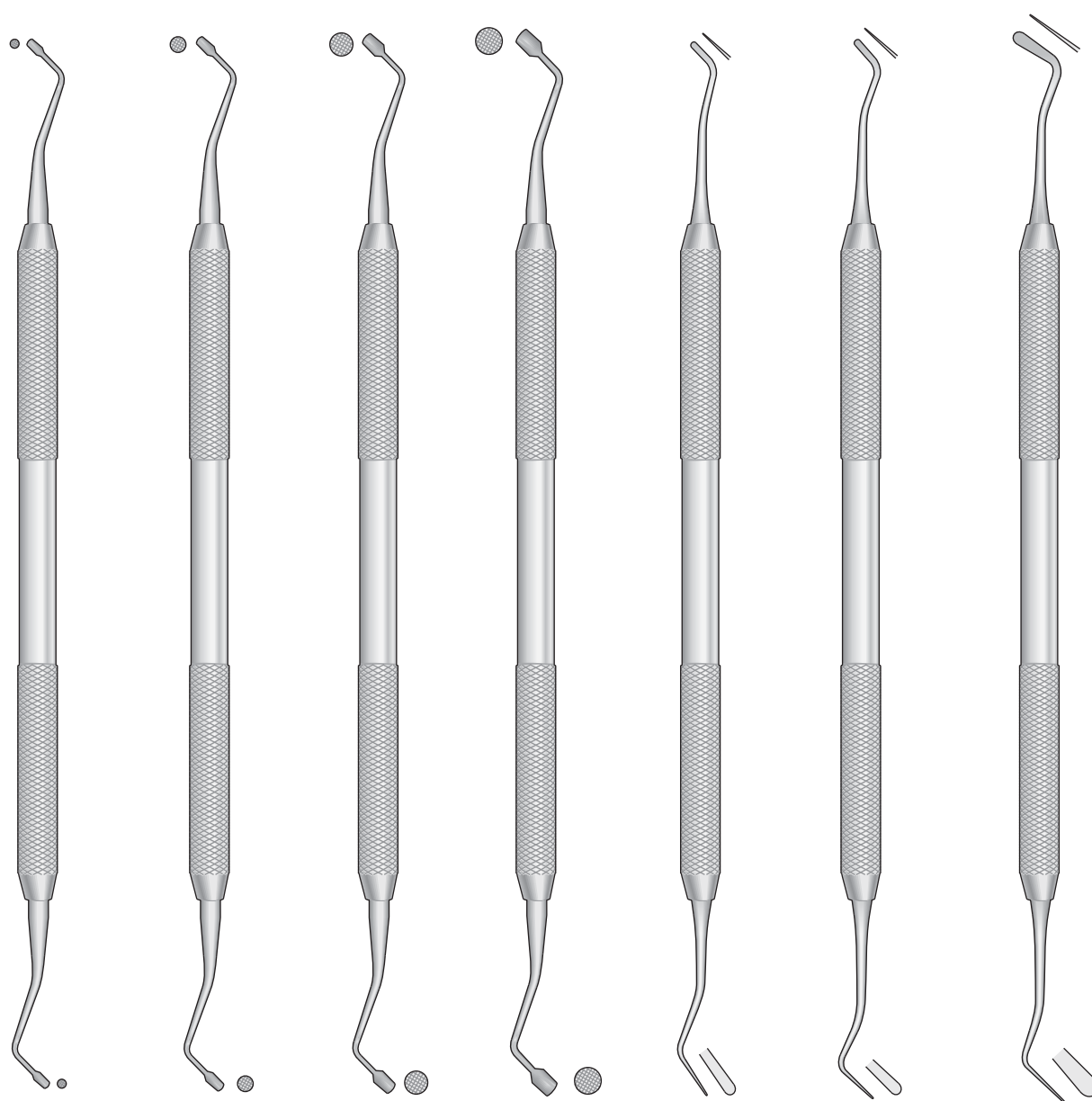

O-1

O-2

O-3

O-4

OK-1

OK-2

OK-3

Gerieft
Serrated
Zigrinati
Estrizados
Striée

Glatt
Smooth
Lisci
Lisos
Lissée

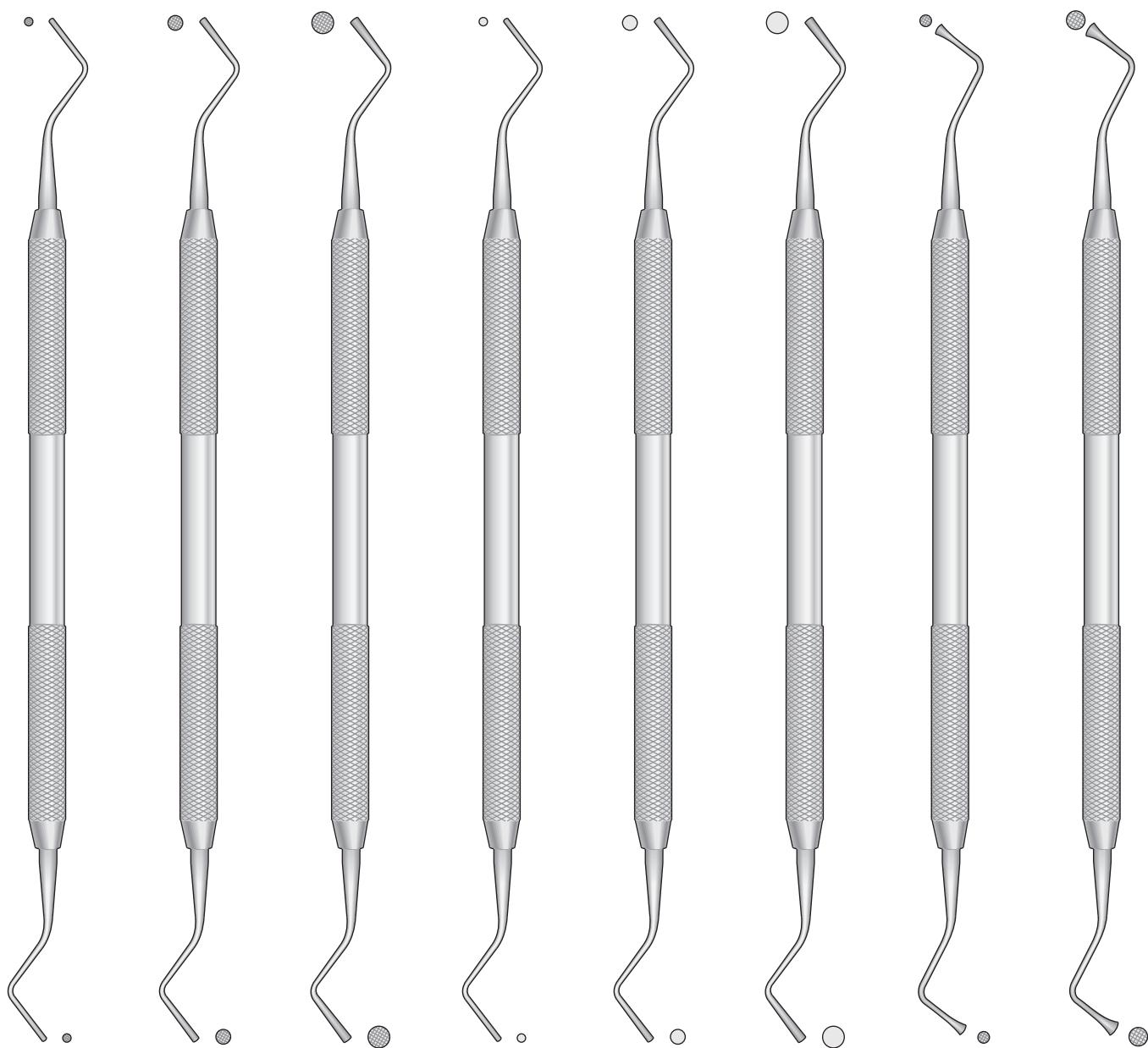

OZ-1
Fig.1

OZ-2
Fig.2

OZ-3
Fig.3

OL-1
Fig.1L

OL-2
Fig.2L

OL-3
Fig.3L

WARD
OC-1

WARD
OC-2



Füllungsinstrumente
Filling Instruments
Strumenti per otturazione
Instrumentos para obturación
Instruments pour obturation

11

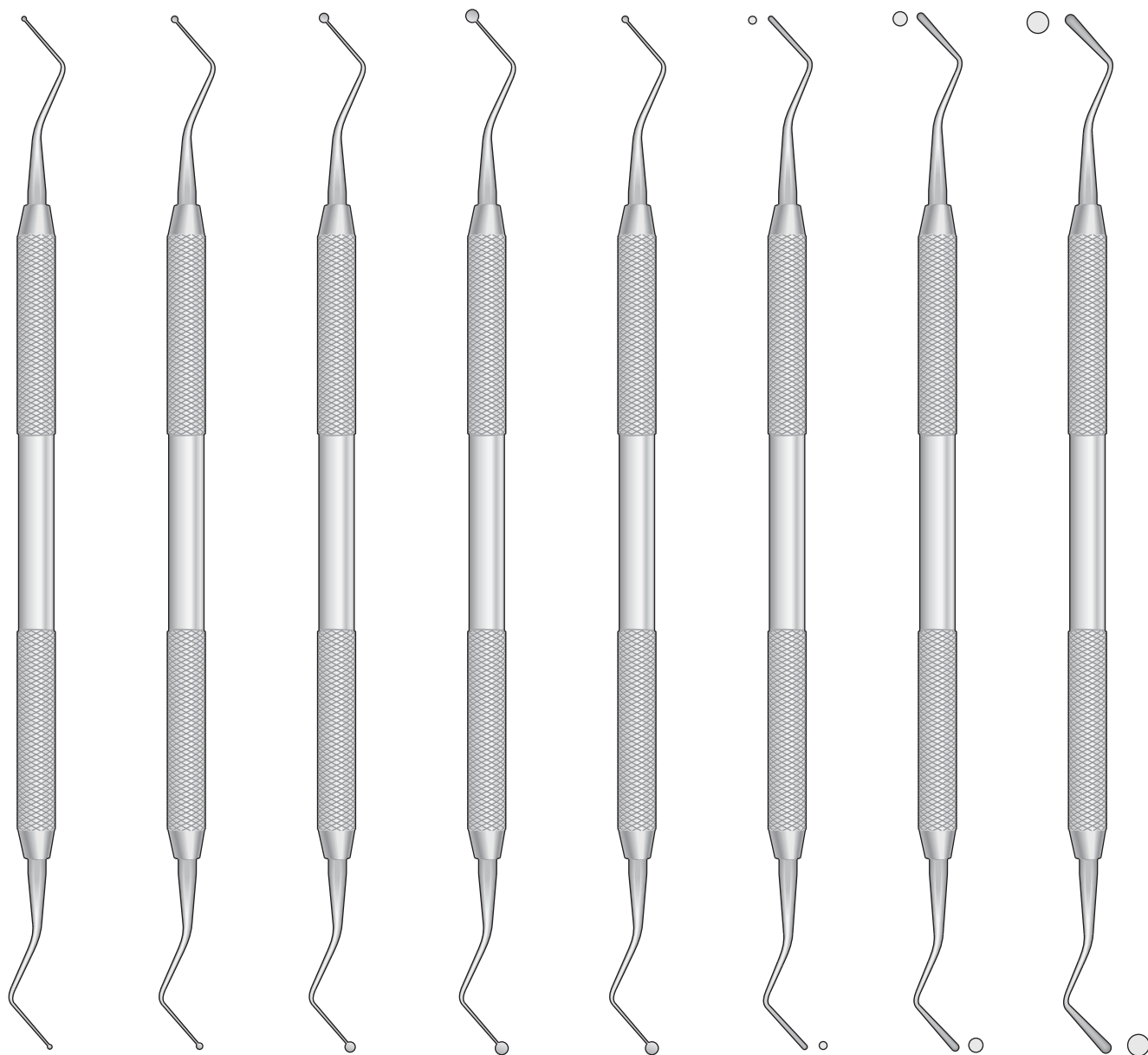

OP-1
Fig.1

OP-2
Fig.2

OP-3
Fig.3

OP-4
Fig.4

OP-5
Fig.5

OA-1
Fig.1

OA-2
Fig.2

OA-3
Fig.3

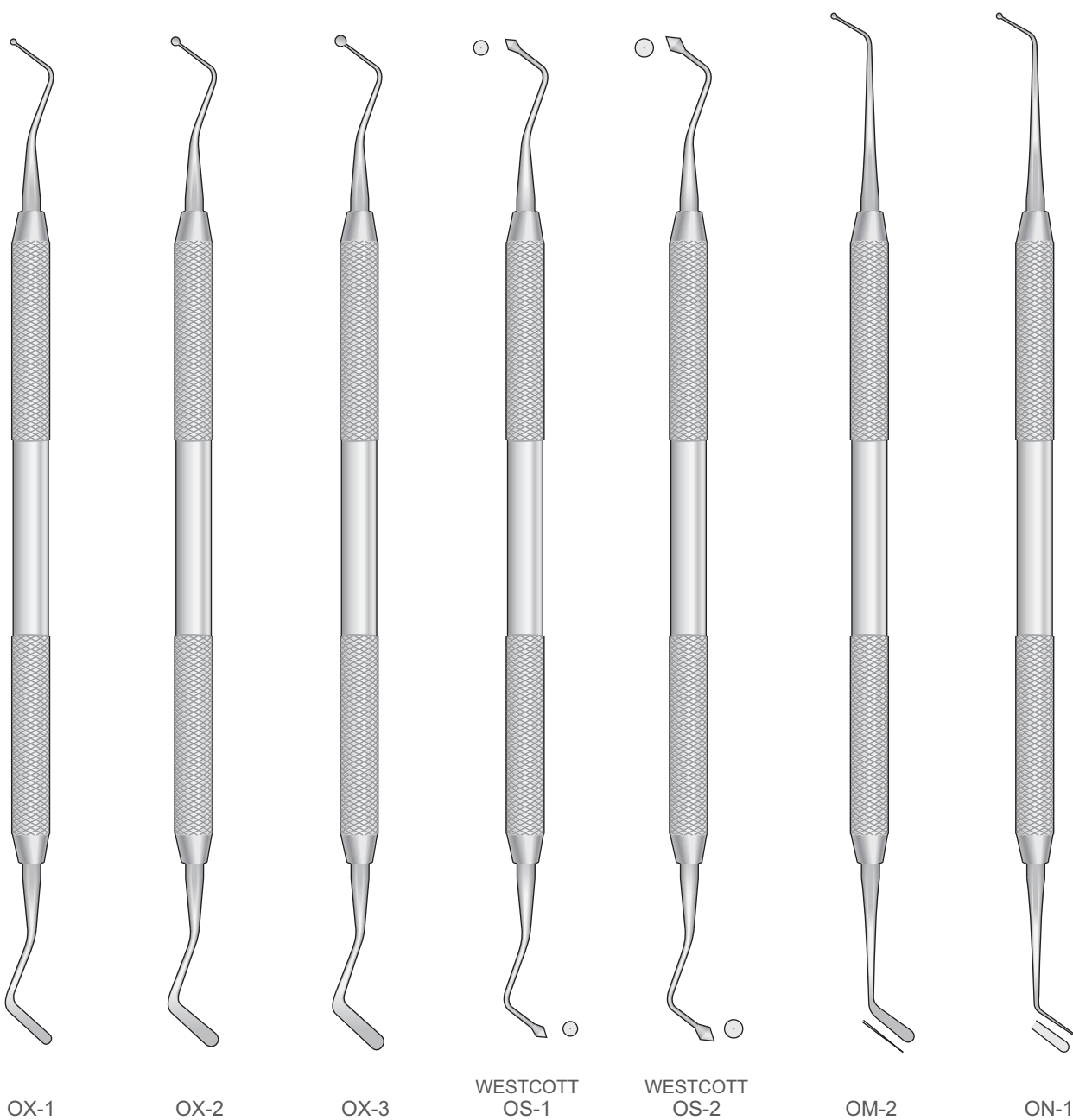



Füllungsinstrumente
Filling Instruments
Strumenti per otturazione
Instrumentos para obturación
Instruments pour obturation



WHITE
B-3
n°28

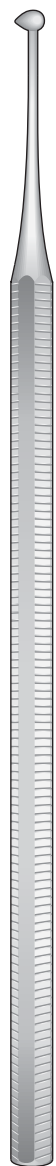

WHITE
B-4
n°29

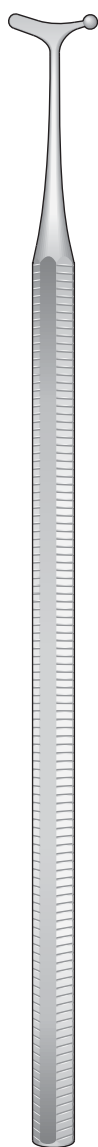

WHITE
B-32
n°32

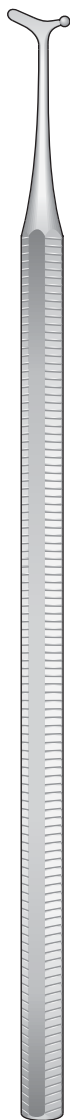

WHITE
B-33
n°33

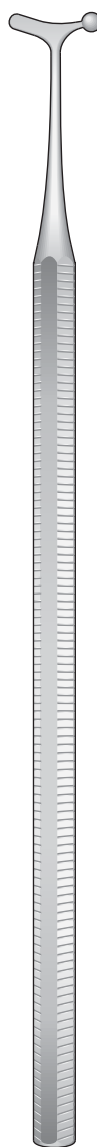

WHITE
B-34
n°34



WHITE
B-28/29
Doppio

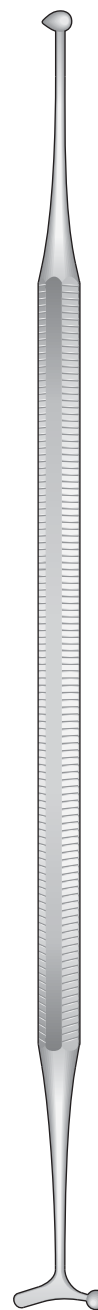

WHITE
B-31/32
Doppio

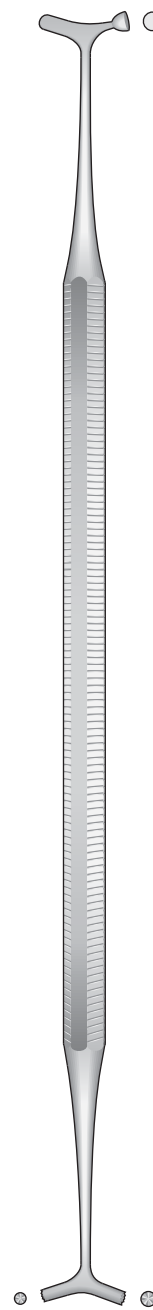

BENNET
B-35
170 mm

MARKLEY PLUGGERS
Amalgam Instrumente
Amalgam Instruments
Strumenti per amalgama
Instrumentos para amalgama
Instruments à amalgame

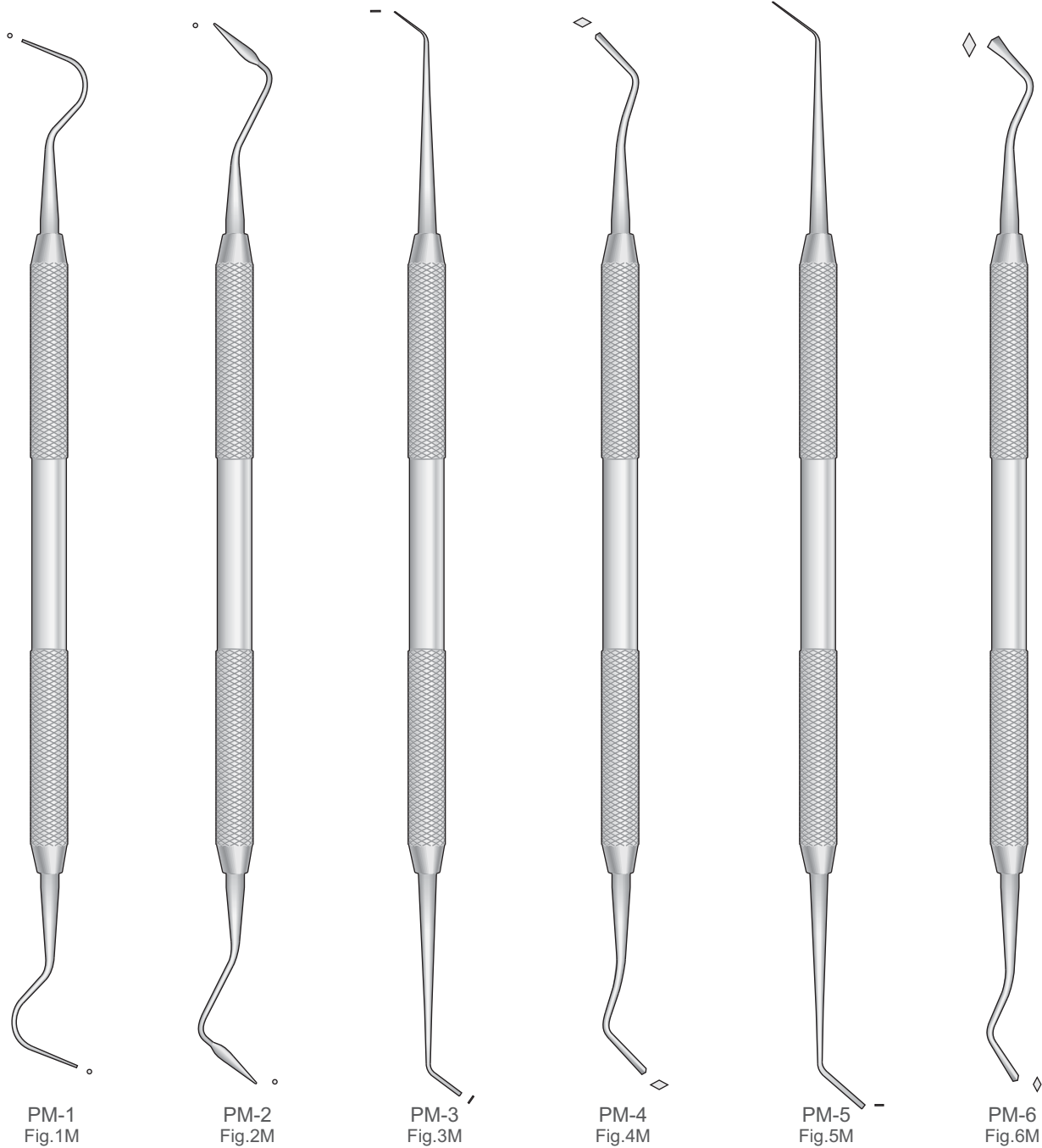

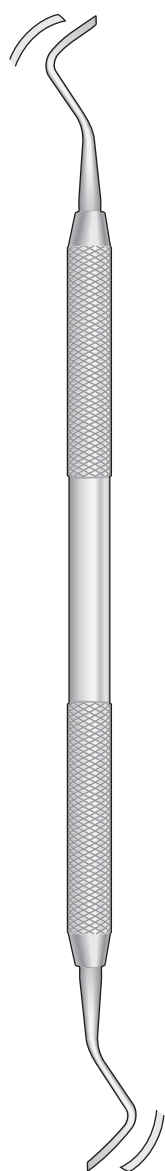

BLACK
TS-1
Fig.26

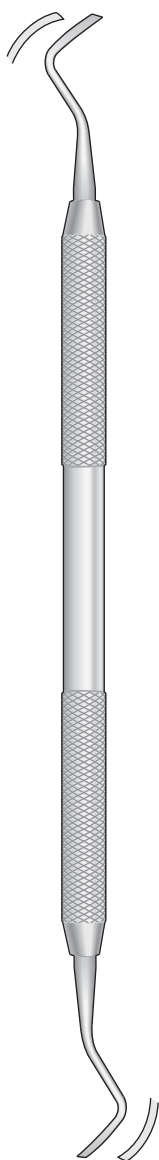

BLACK
TS-2
Fig.27

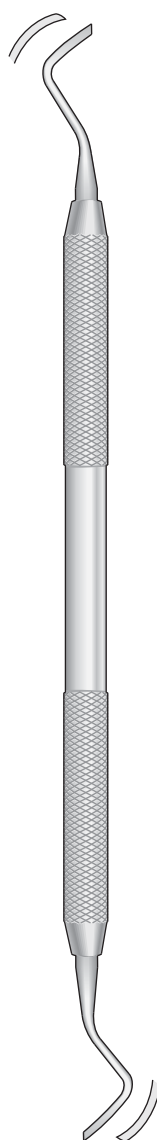

BLACK
TS-3
Fig.28

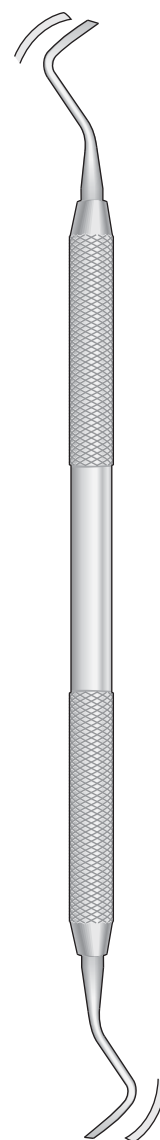

BLACK
TS-4
Fig.29

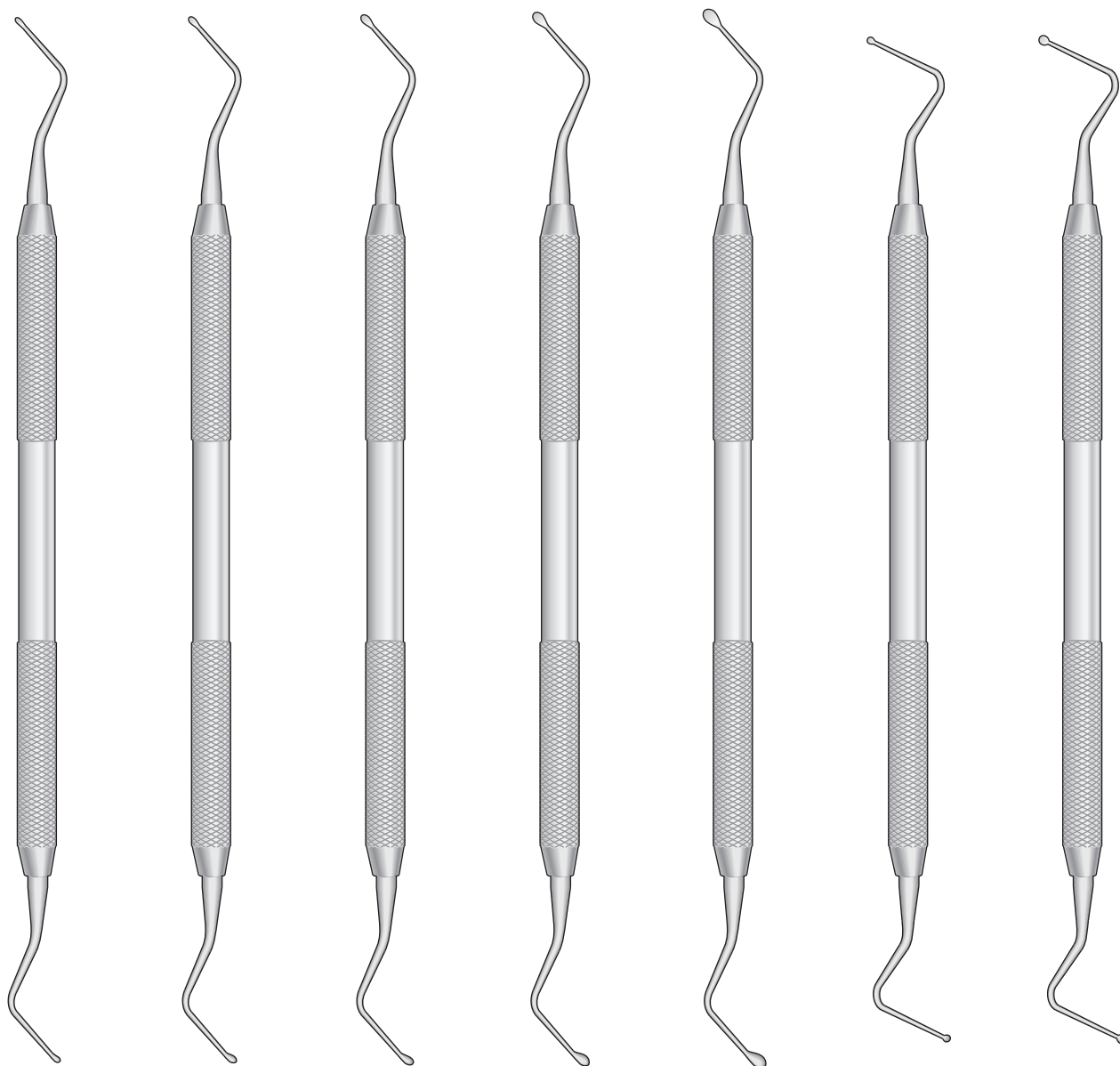

E-0
Fig.0

E-1
Fig.1

E-2
Fig.2

E-3
Fig.3

E-4
Fig.4

EC-1
Fig.1

EC-2
Fig.2



Meißel für Parodontologie
Periodontal Chisels
Scalpelli parodontali
Cinceles periodontales
Burins parodontaux

Fig. 1

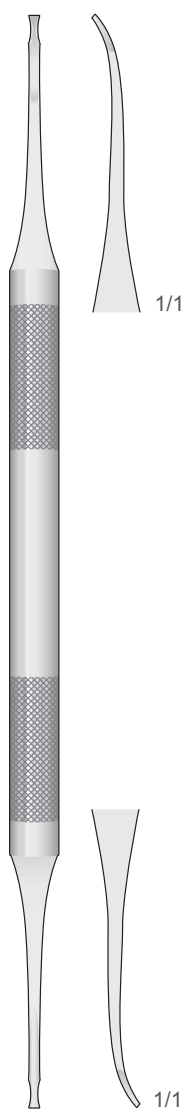

FEDI
OF-1
175 mm

Fig. 2

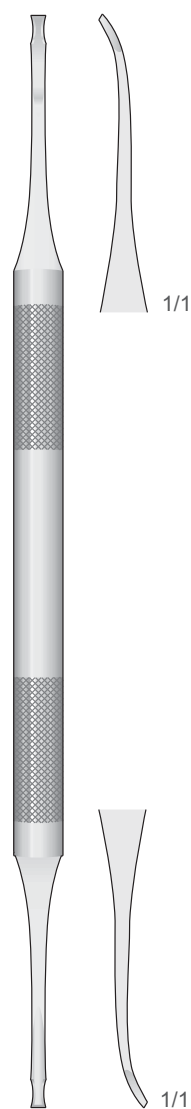

FEDI
OF-2
175 mm

Fig. 3



FEDI
OF-3
170 mm

Fig. 4



OCHSENBEIN
OSB-4A
170 mm



OSB-4
170 mm

Bevel IN
Fig.1



OUCHSENBEIN-1
OSB-1
165 mm

Bevel OUT
Fig.2



OUCHSENBEIN-2
OSB-2
165 mm



TG CHISELS
718-113

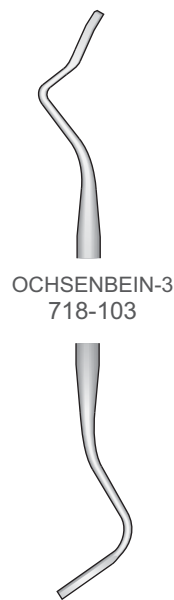

OCHSENBEIN-3
718-103



OCHSENBEIN-4
718-104



RHODES BACK ACTION
718-107



Parodontalmesser
Gingivectomy Knives
Bisturi per gengivectomia
Bisturís para la gengivectomía
Bistouris pour la gengivectomie

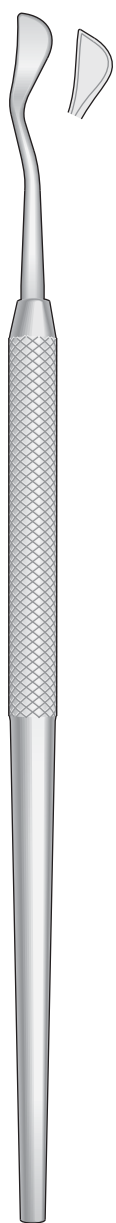

KIRKLAND
KKD-1
Fig.15K

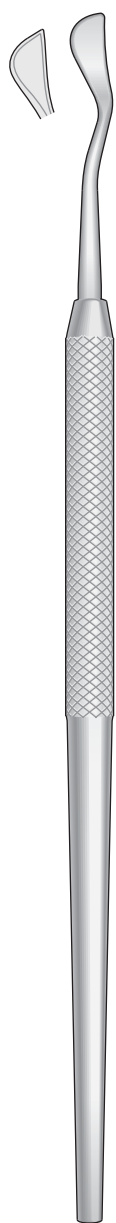

KIRKLAND
KKD-2
Fig.16K

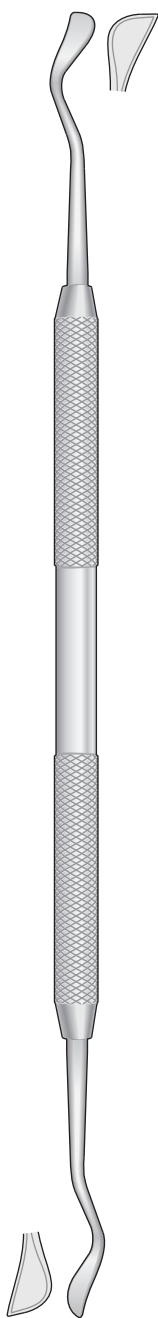

KIRKLAND
KKD-4
Fig.15K - Fig.16K

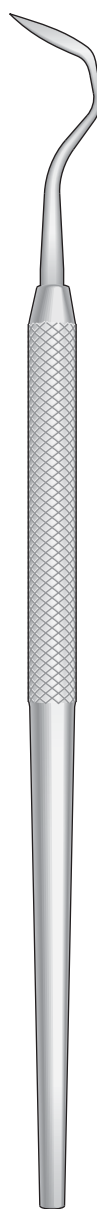

ORBAN
OBN-1
Fig.1

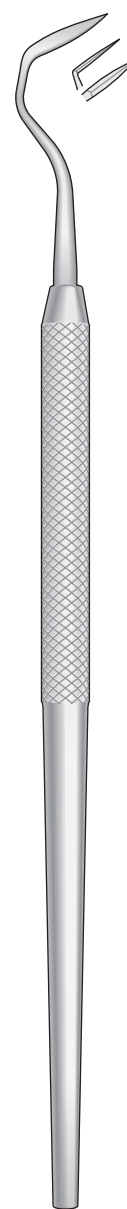

ORBAN
OBN-2
Fig.2

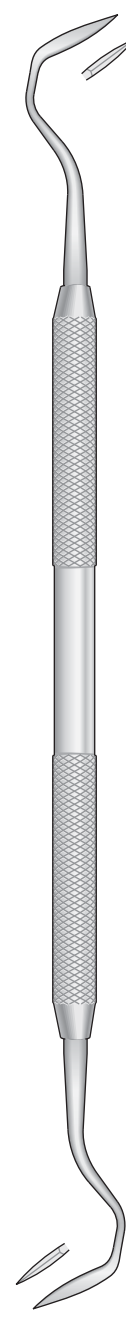

ORBAN
OBN-4
Fig.1 - Fig.2

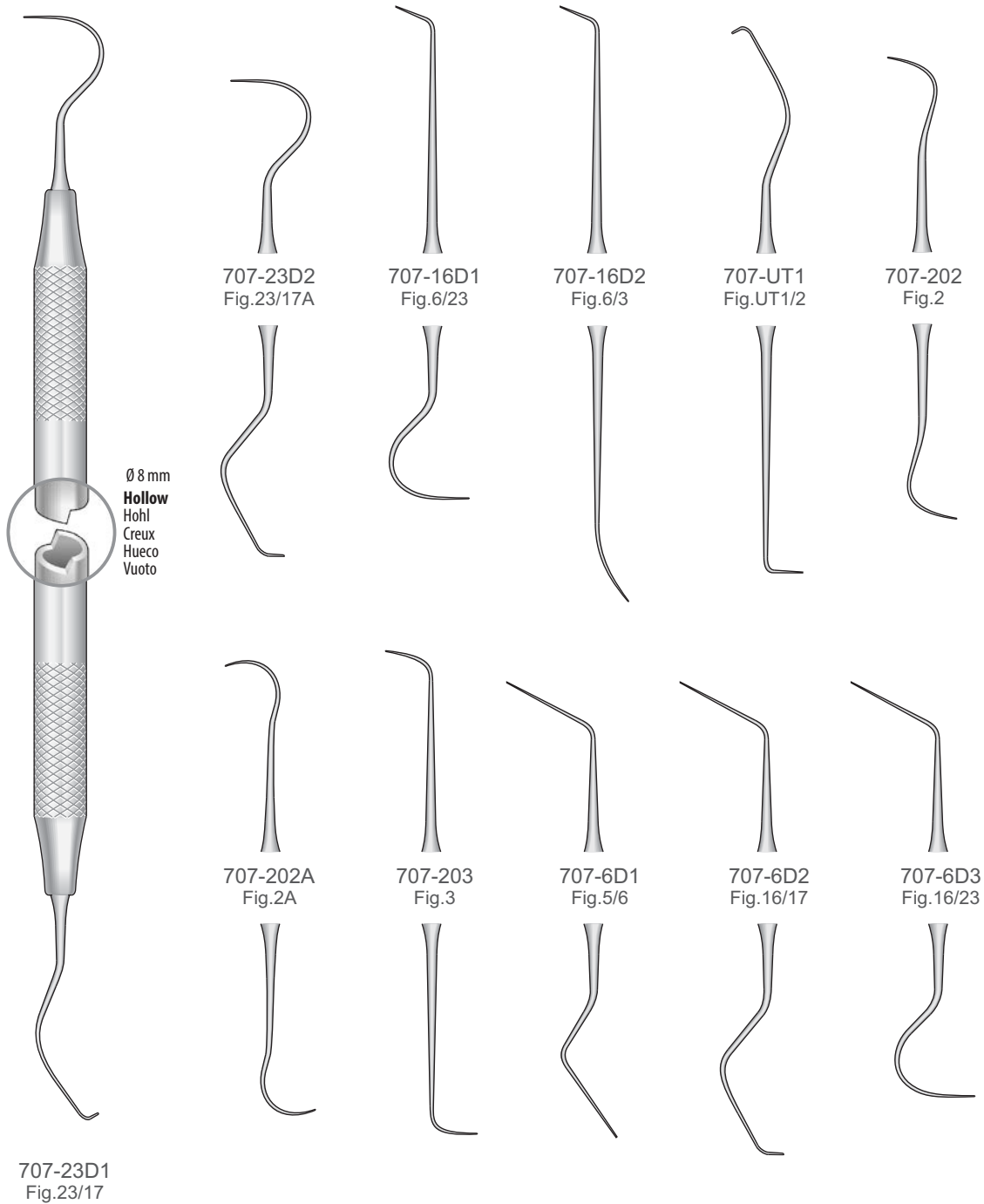



Doppelendiger Parodontometer
Double-ended Periodontal Probes
Sondes parodontales doubles
Sonde parodontali doppie
Sondas parodontales doubles

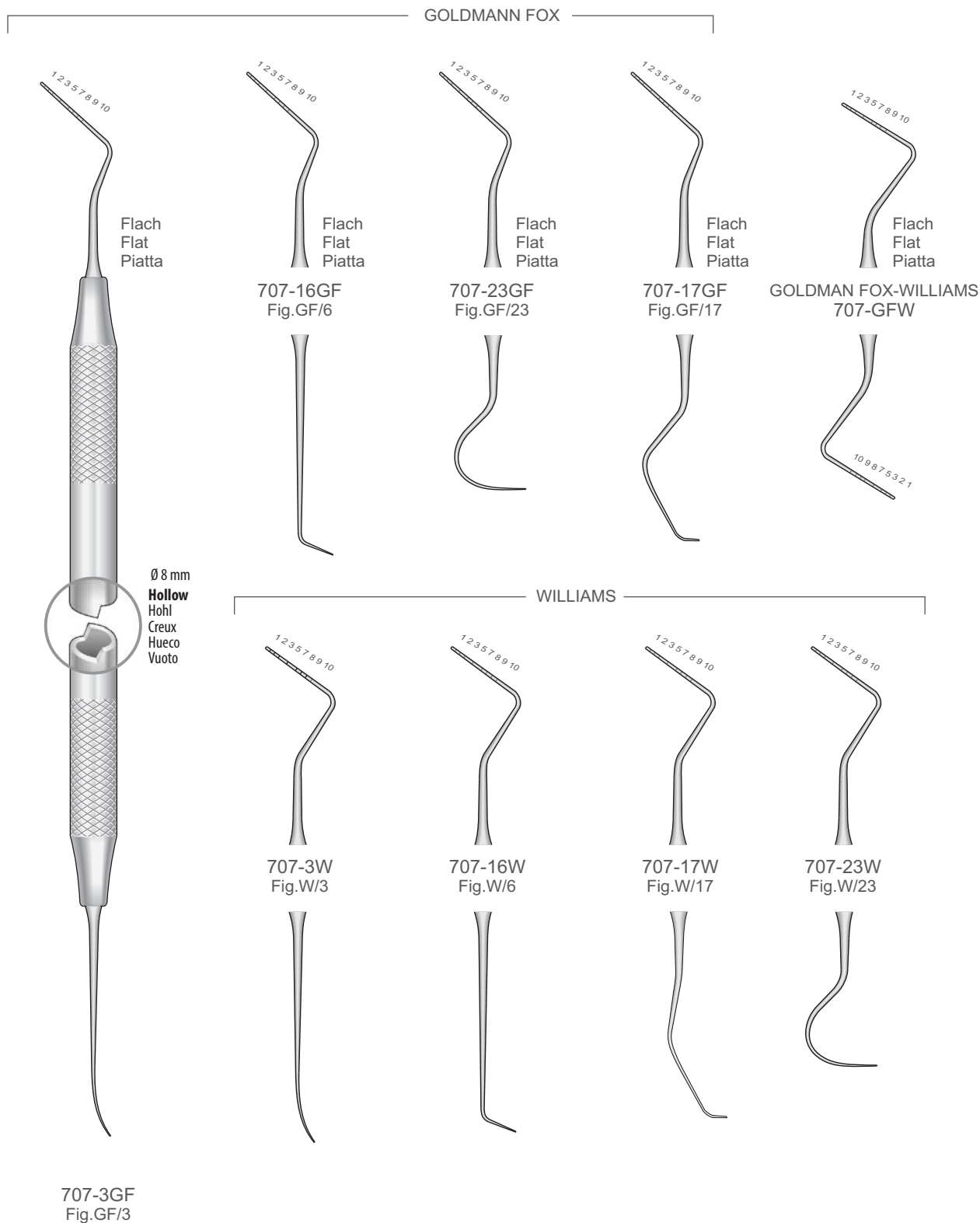

UNIVERSITY OF MICHIGAN

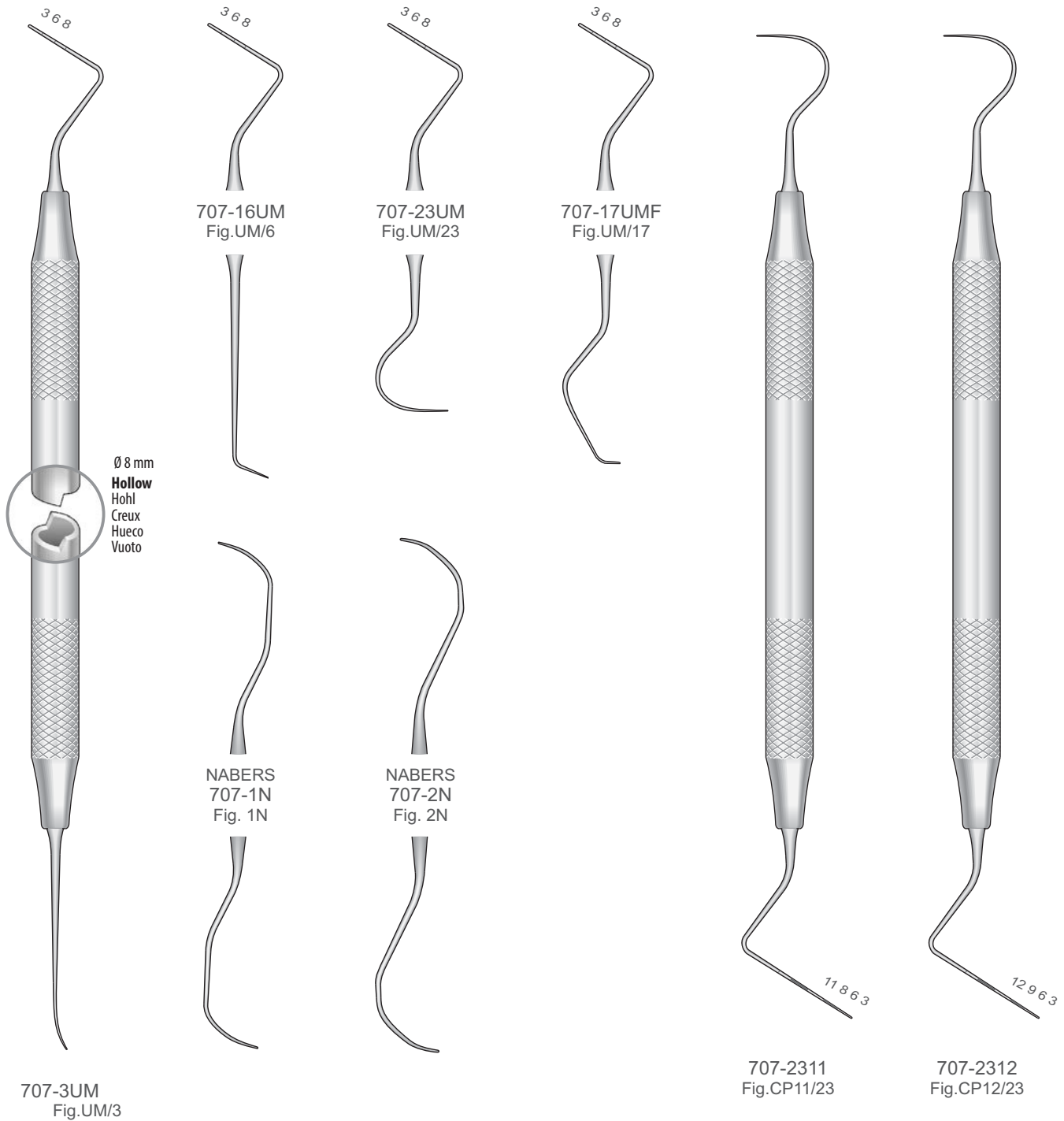



Spateln - Füllungsinstrumente
Spatulas - Filling Instruments
Spatole -Strumenti per otturazione
Espátulas - Instrumentos para obturación
Spatules - Instruments pour obturation

Heidemann Spateln
Heidemann Spatulas
Spatole Heidemann
Espátulas Heidemann
Spatules Heidemann

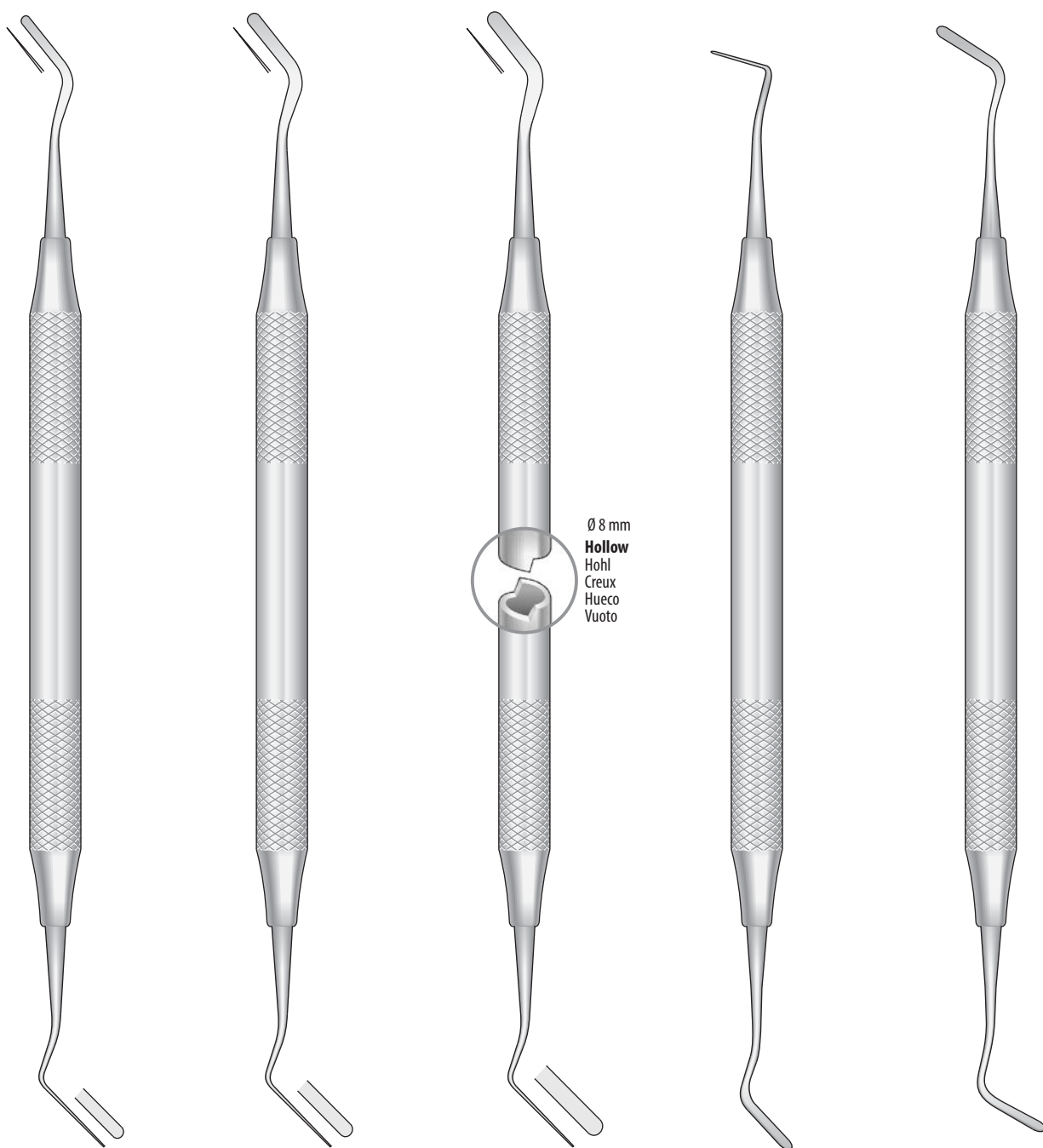

Ø 8 mm
Hollow
Hohl
Creux
Hueco
Vuoto

HEIDEMANN
711-301
Fig.1

HEIDEMANN
711-302
Fig.2

HEIDEMANN
711-303
Fig.3

IPC Fig. 1
715-311
Interproximal

IPC/OA Fig. 2
715-312
Interproximal Off-Angle

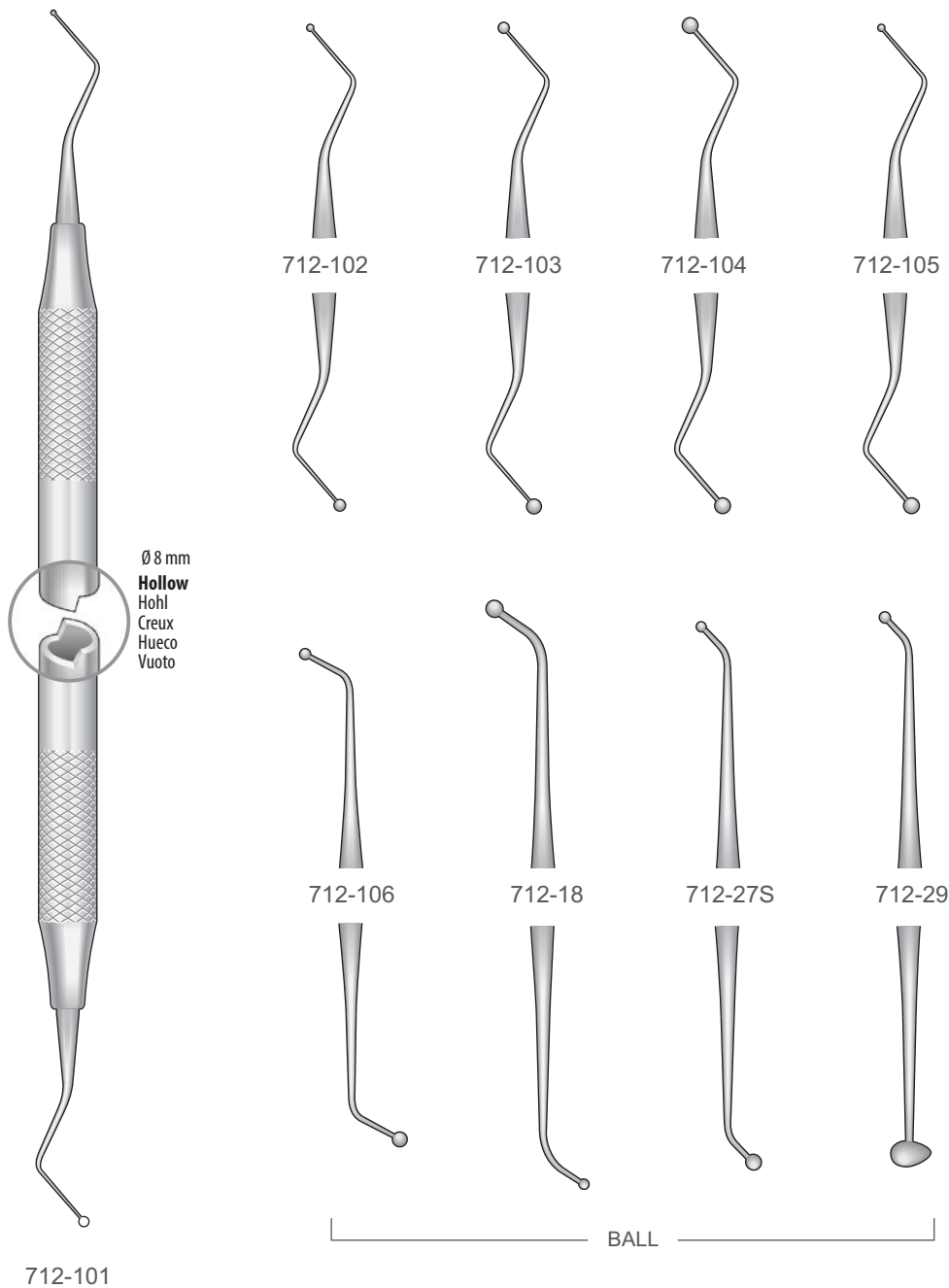



Füllungsinstrumente
Filling Instruments
Strumenti per otturazione
Instrumentos para obturación
Instruments pour obturation

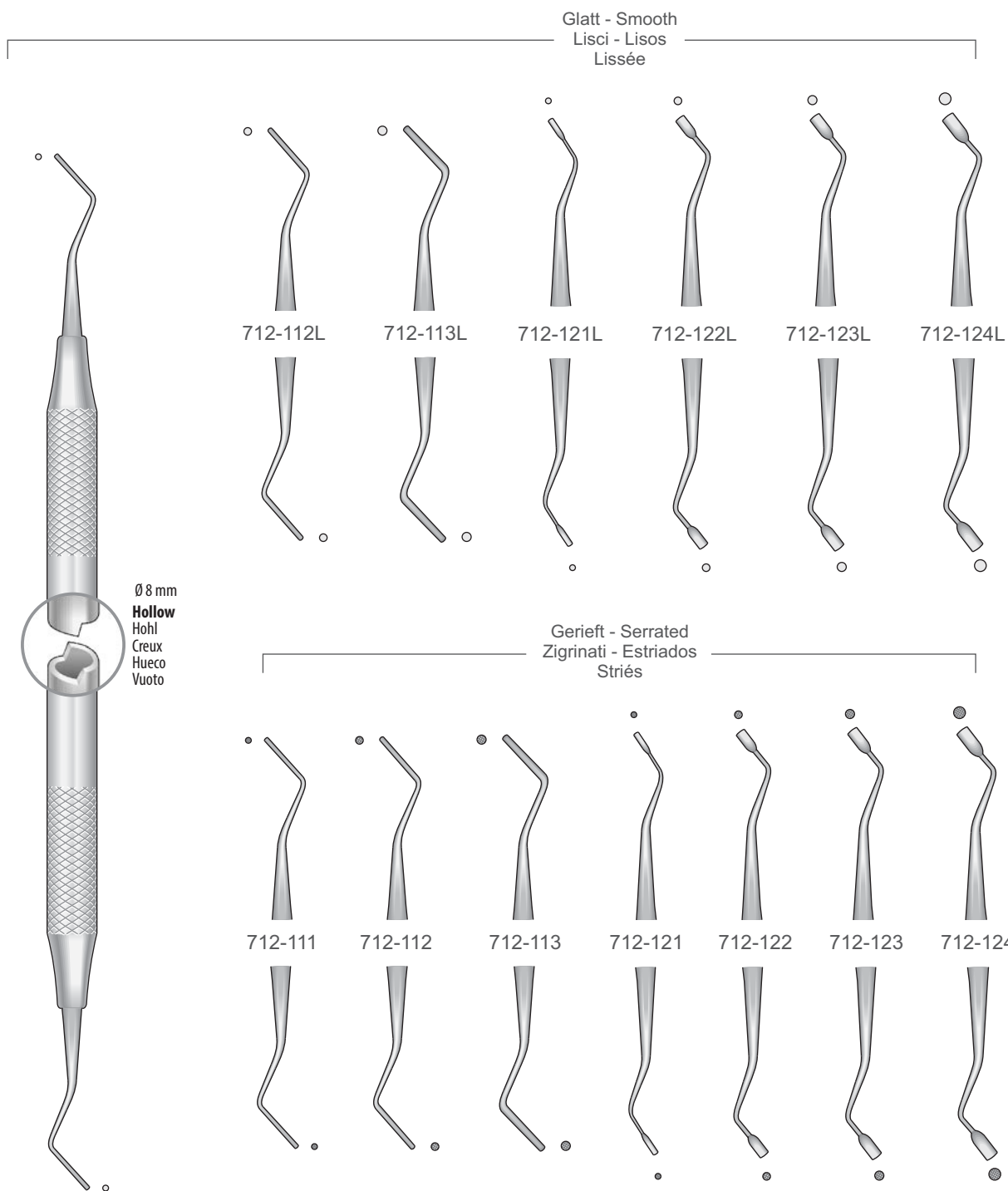

712-111L

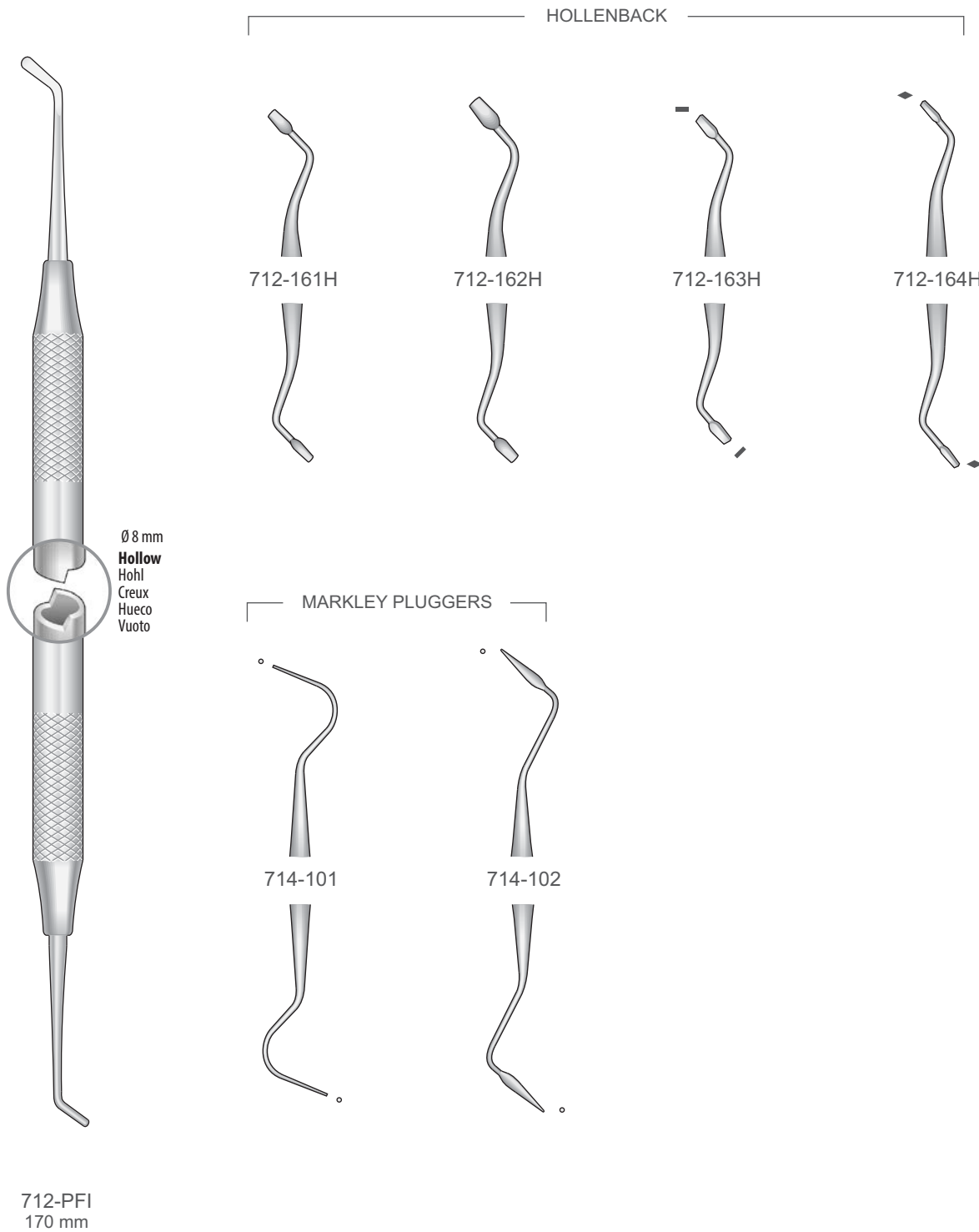



Füllungsinstrumente
Filling Instruments
Strumenti per otturazione
Instrumentos para obturación
Instruments pour obturation

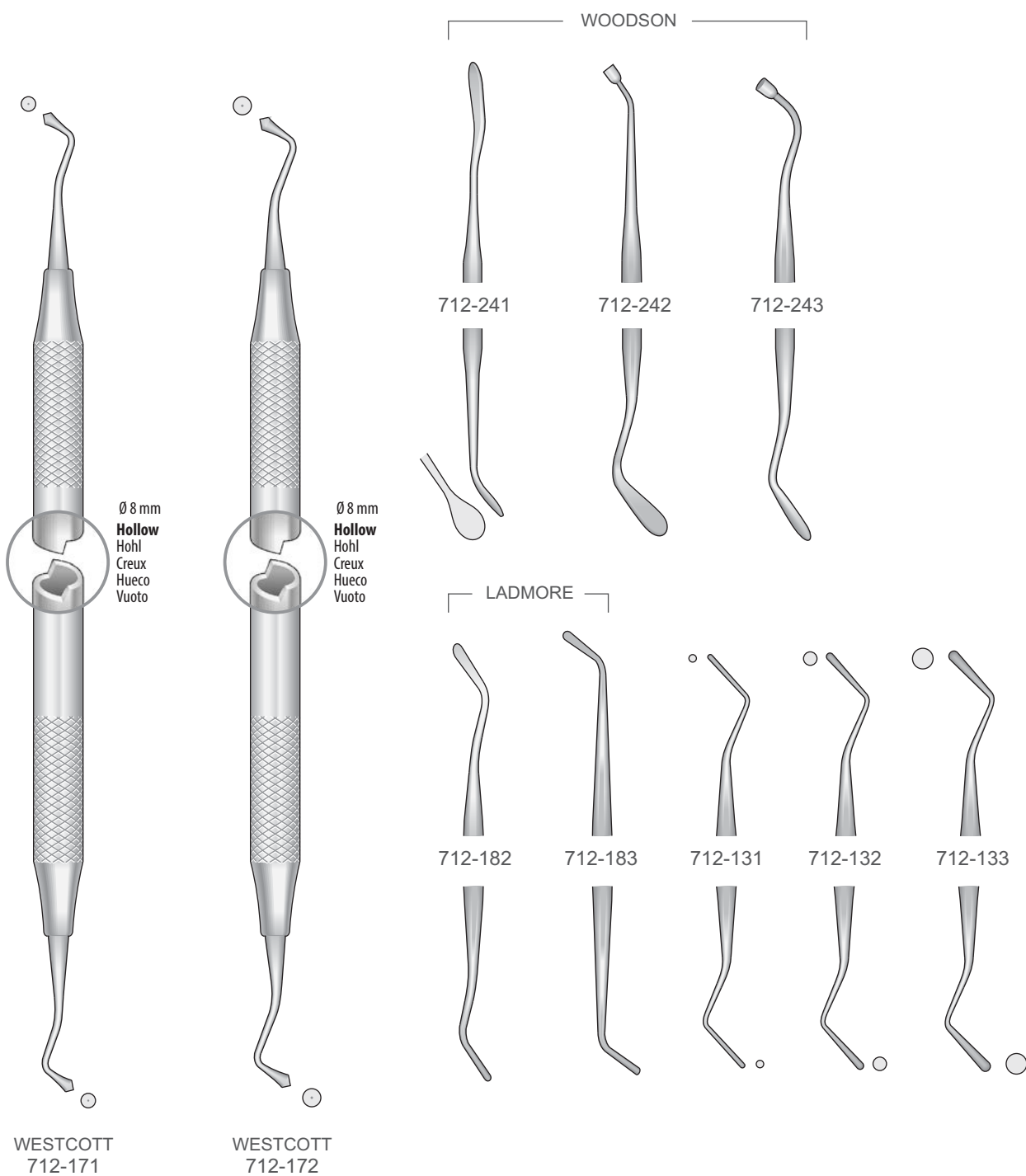

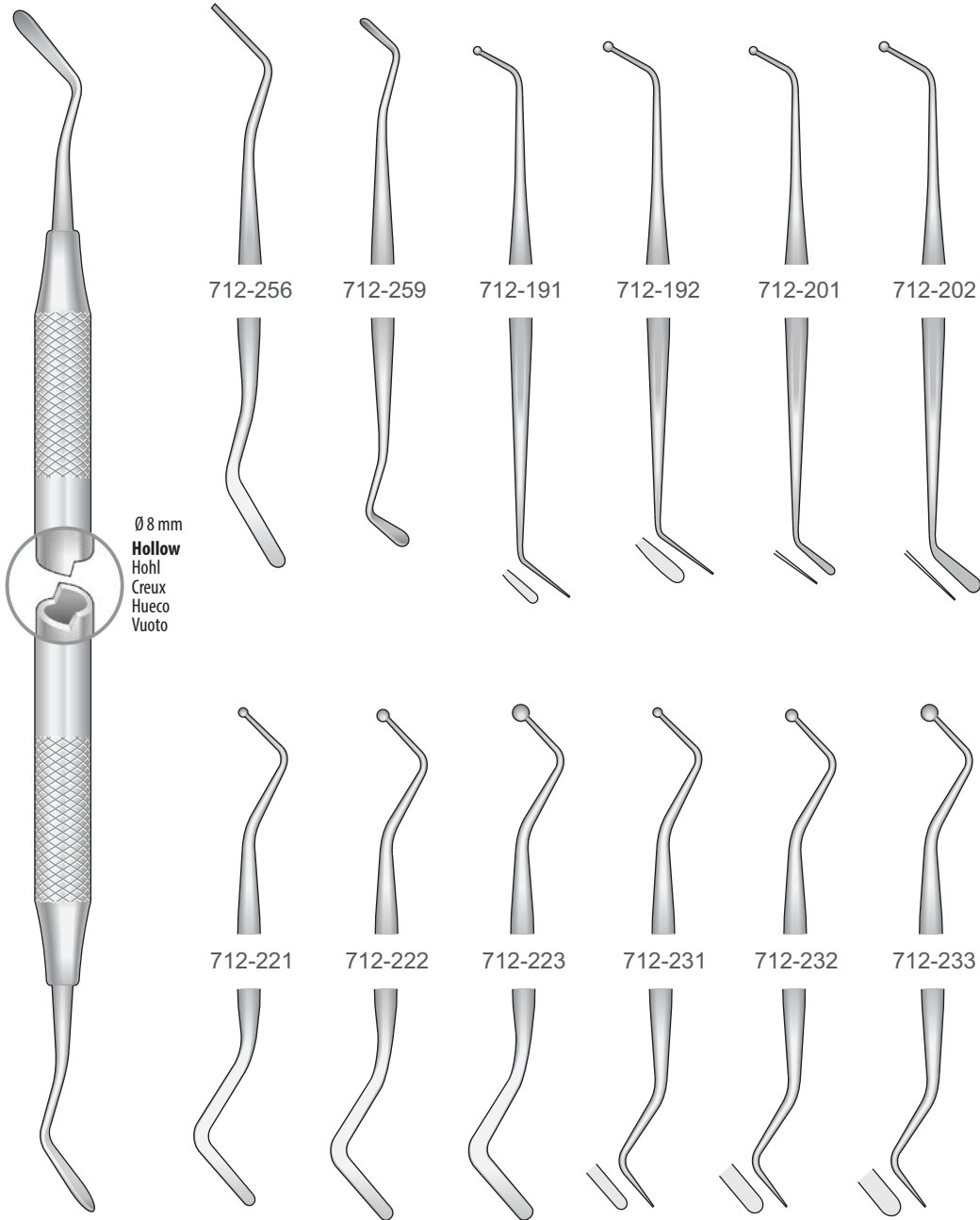

Ø 8 mm
Hollow
Hohl
Creux
Hueco
Vuoto

712-251



Amalgam Instrumente
Amalgam carvers
Strumenti per modellare otturazioni
Instrumentos para modelar las obturaciones
Instruments à modeler les obturations

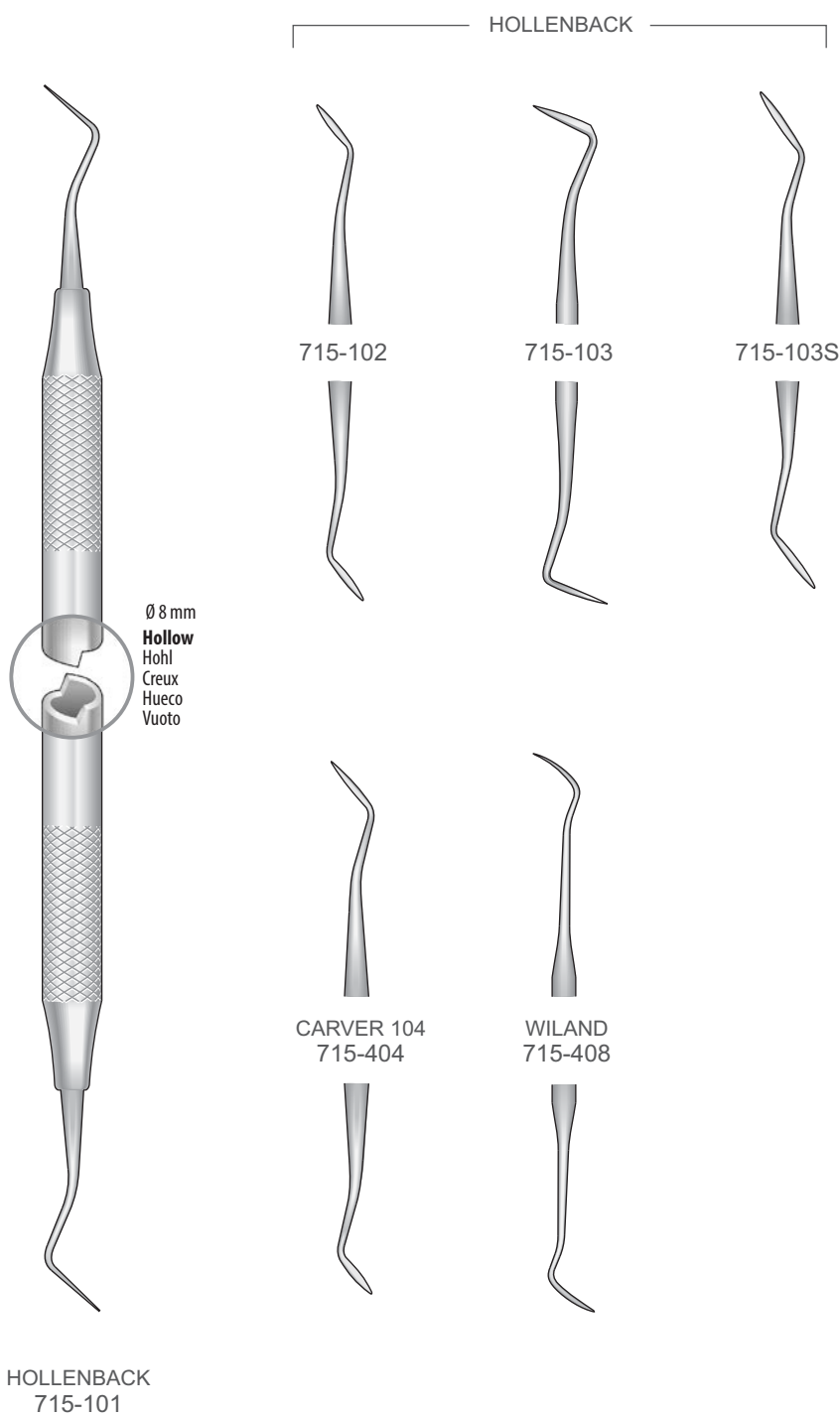

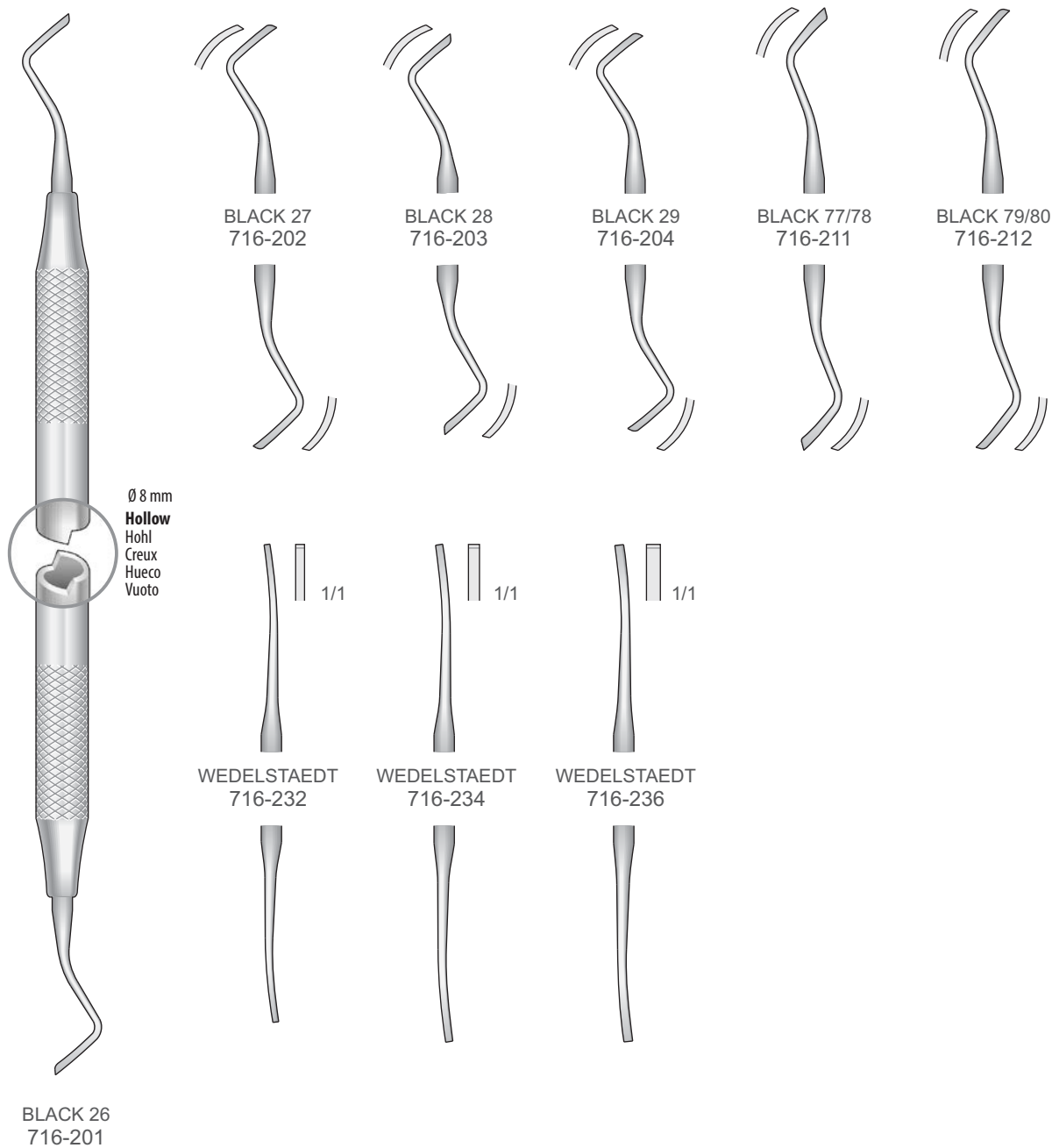



Amalgam Instrumente
Amalgam carvers
Strumenti per modellare otturazioni
Instrumentos para modelar las obturaciones
Instruments à modeler les obturations

Instrument für Drahrückzug
Instrument for Retractor wire
Strumento per filo retrattore
Instrumento para hilo retractor
Instruments pour fil rtracteur

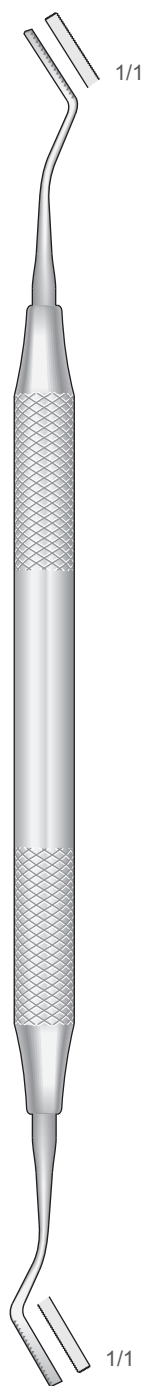

714-CV11

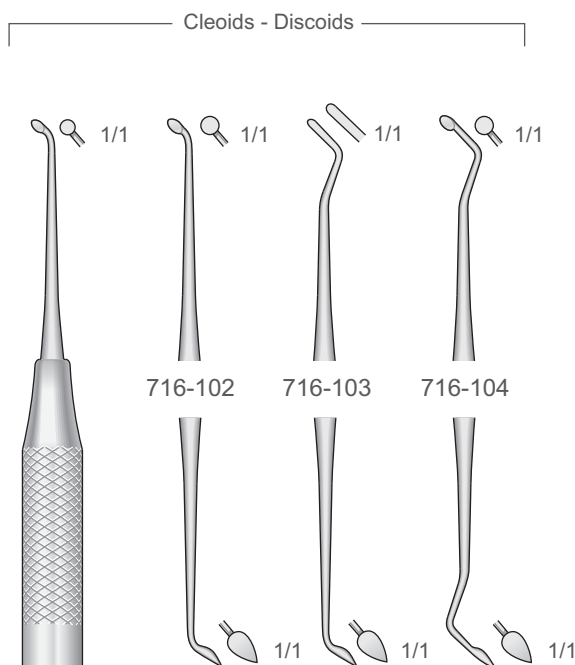

Cleoids - Discoids

716-102

716-103

716-104

Ø 8 mm
Hollow
Hohl
Creux
Hueco
Vuoto

716-101

Dykal Applikator
Placement Instruments
Applicatori per sottofondo
Aplicadores de fondo de cavidades
Applicateurs de fond de cavité

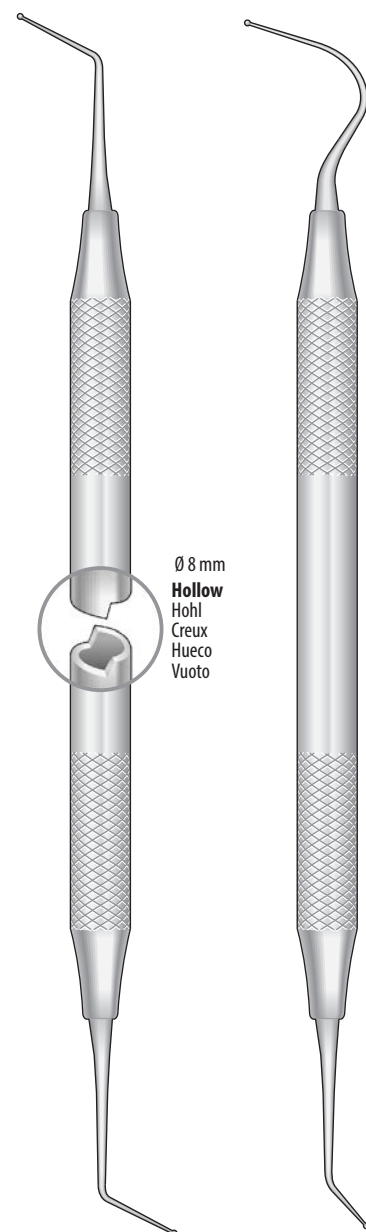

Ø 8 mm
Hollow
Hohl
Creux
Hueco
Vuoto

713-101

713-102

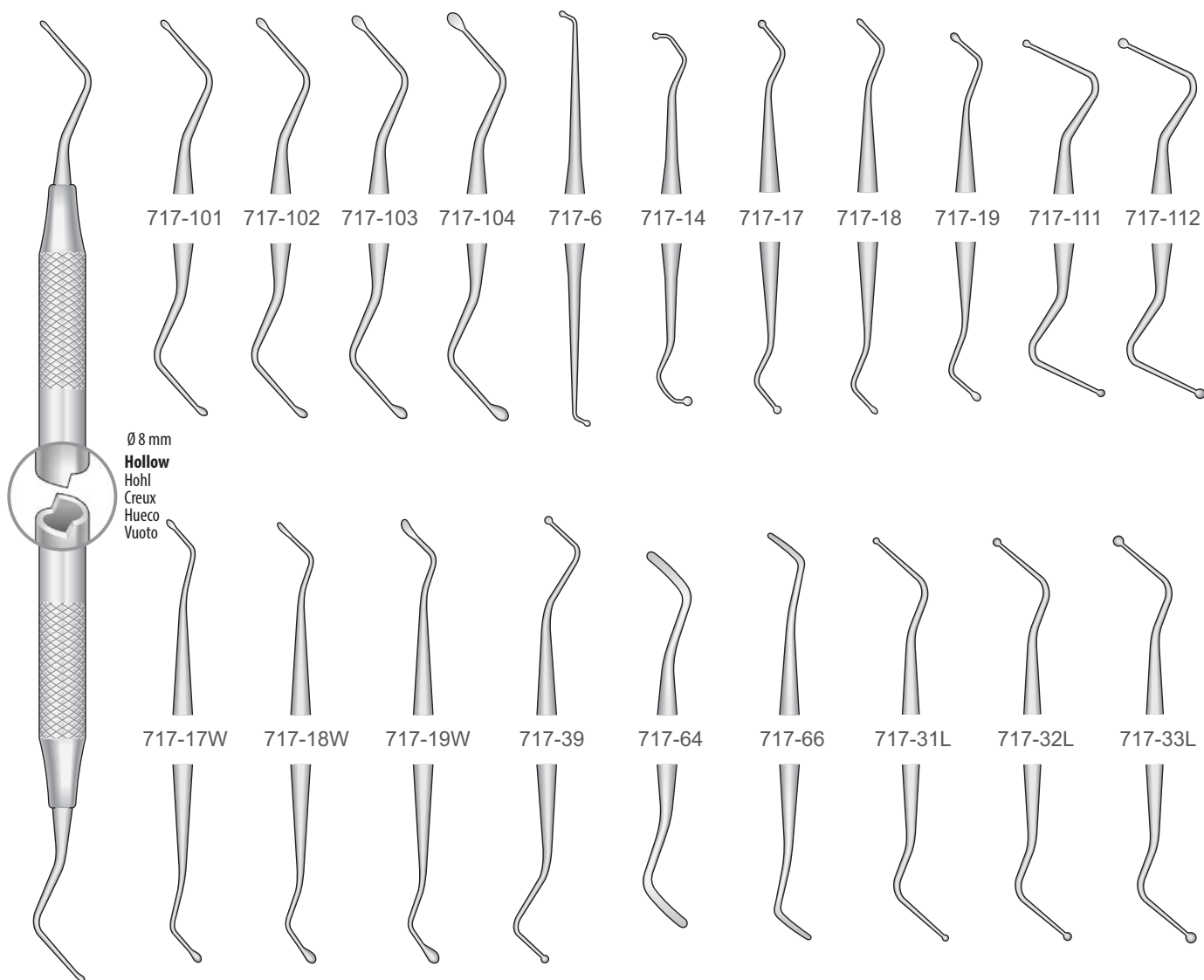

717-100



Parodontalmesser
Gingivectomy knives
Bisturi per gengivectomia
Bisturís para la gingivectomía
Bistouris pour la gingivectomie

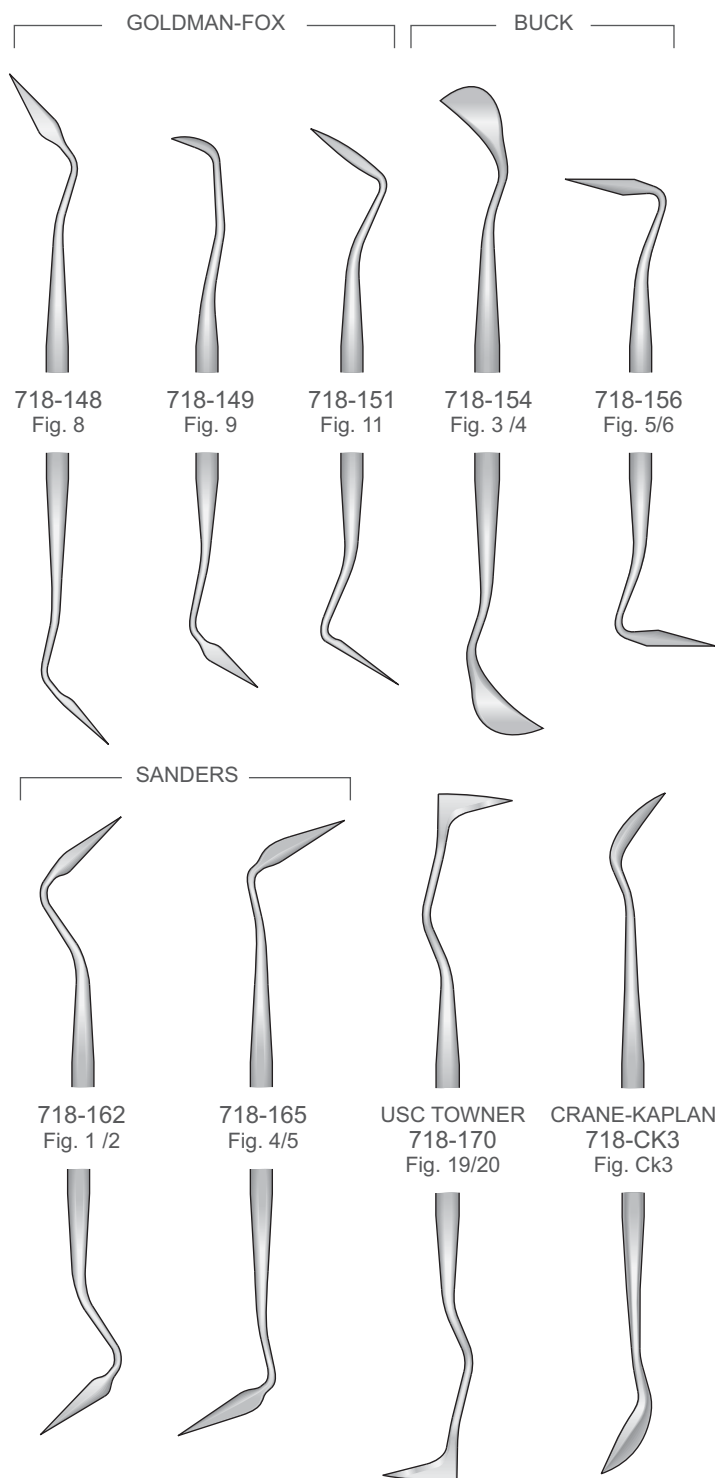
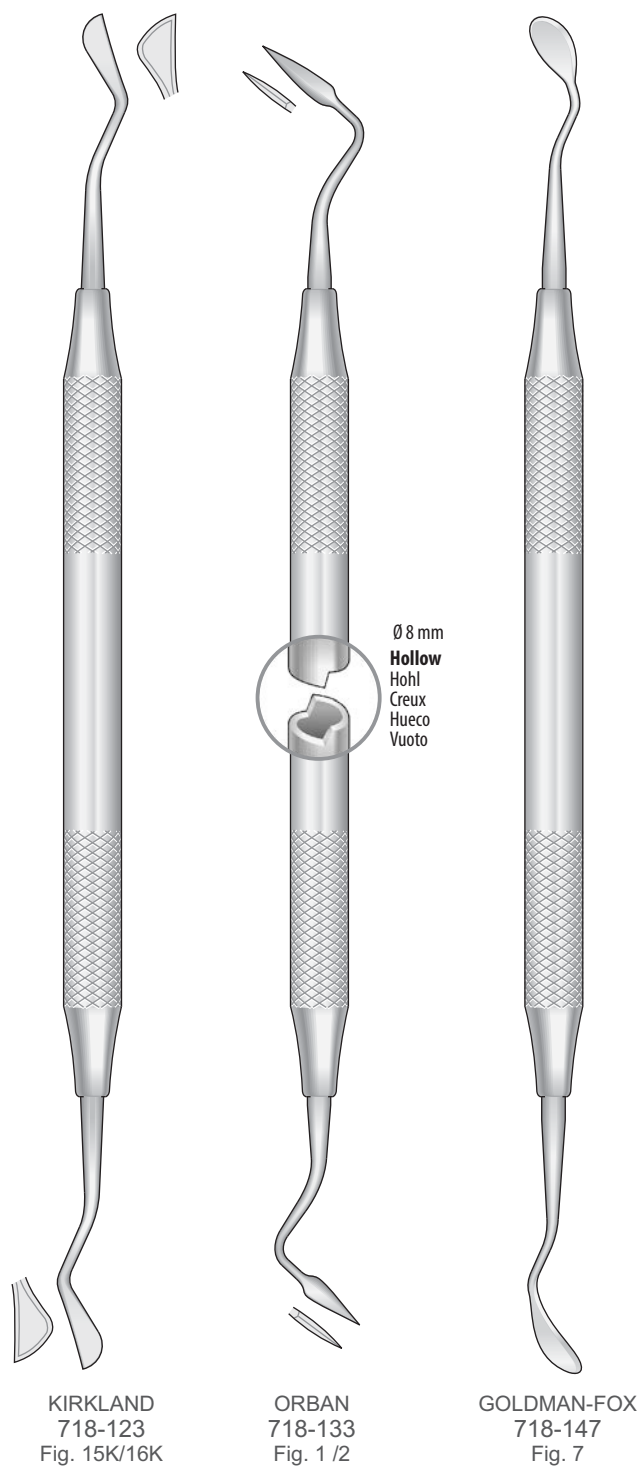

GRACEY

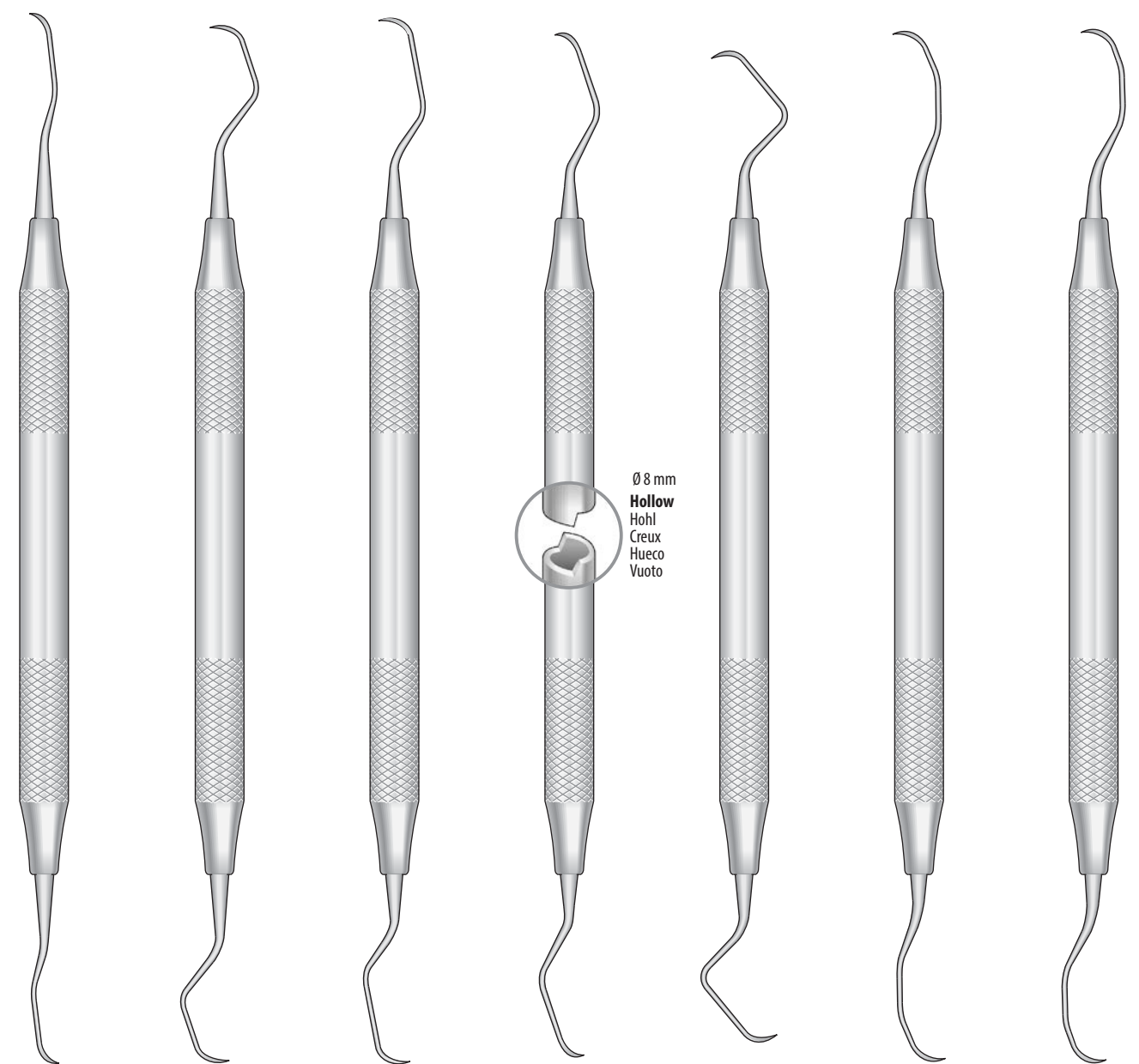

GRACEY
718-1/2

GRACEY
718-3/4

GRACEY
718-5/6

GRACEY
718-7/8

GRACEY
718-9/10

GRACEY
718-11/12

GRACEY
718-13/14



Küretten
Curettes
Curette
Curetas
Curettes

Mesial - Distal

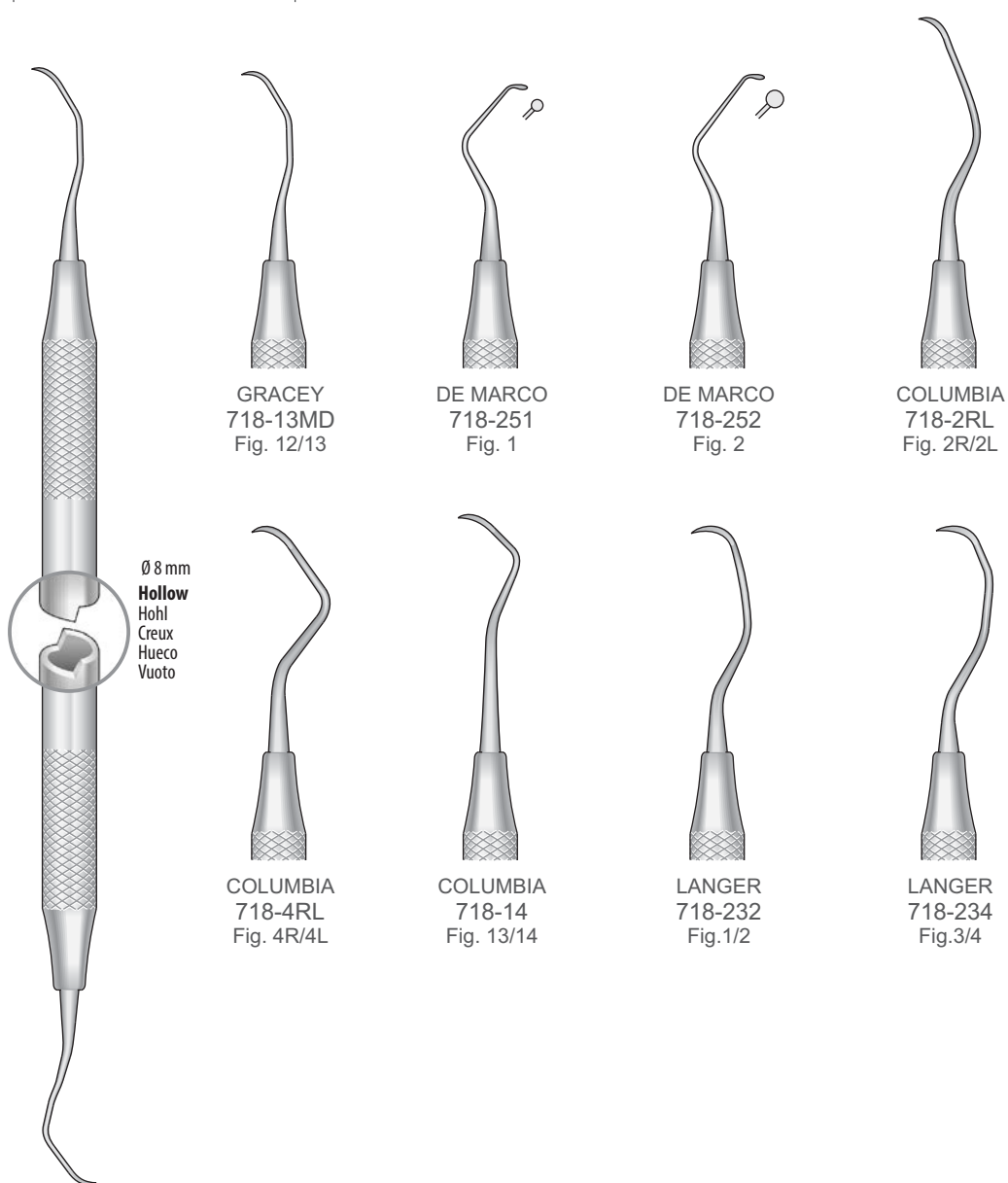

GRACEY
718-11MD
Fig. 11/14

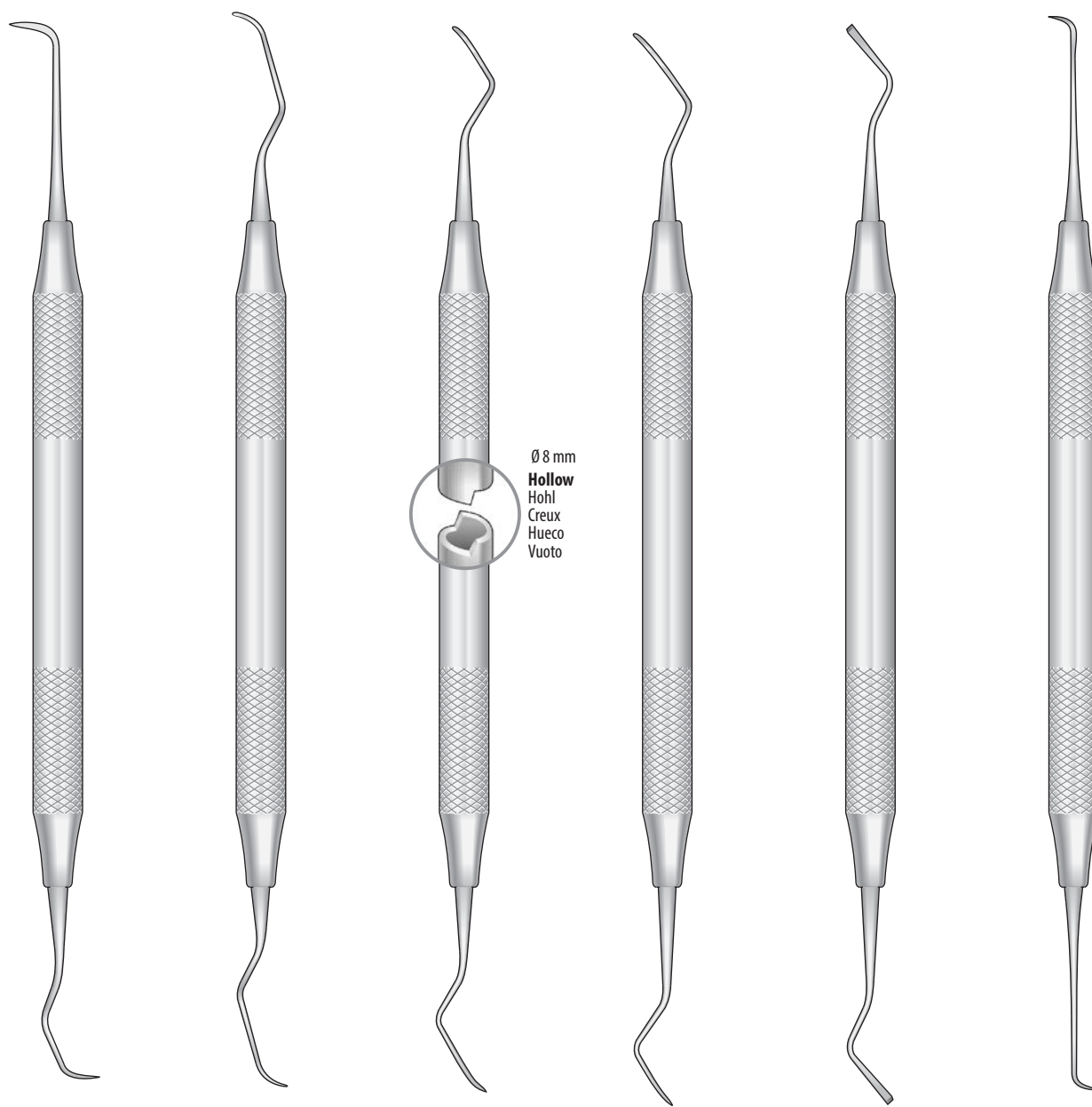

Ø 8 mm
Hollow
Hohl
Creux
Hueco
Vuoto

GOLDMAN-FOX
718-271
Fig. 1

GOLDMAN-FOX
718-272
Fig. 2

GOLDMAN-FOX
718-273
Fig. 3

GOLDMAN-FOX
718-274
Fig. 4

GOLDMAN-FOX
718-275
Fig. 5

GOLDMAN-FOX
718-277
Fig. 21



Scaler und Küretten
Scalers and Curettes
Scaler e Curette
Raspadores y Curetas
Détartreurs et Curettes

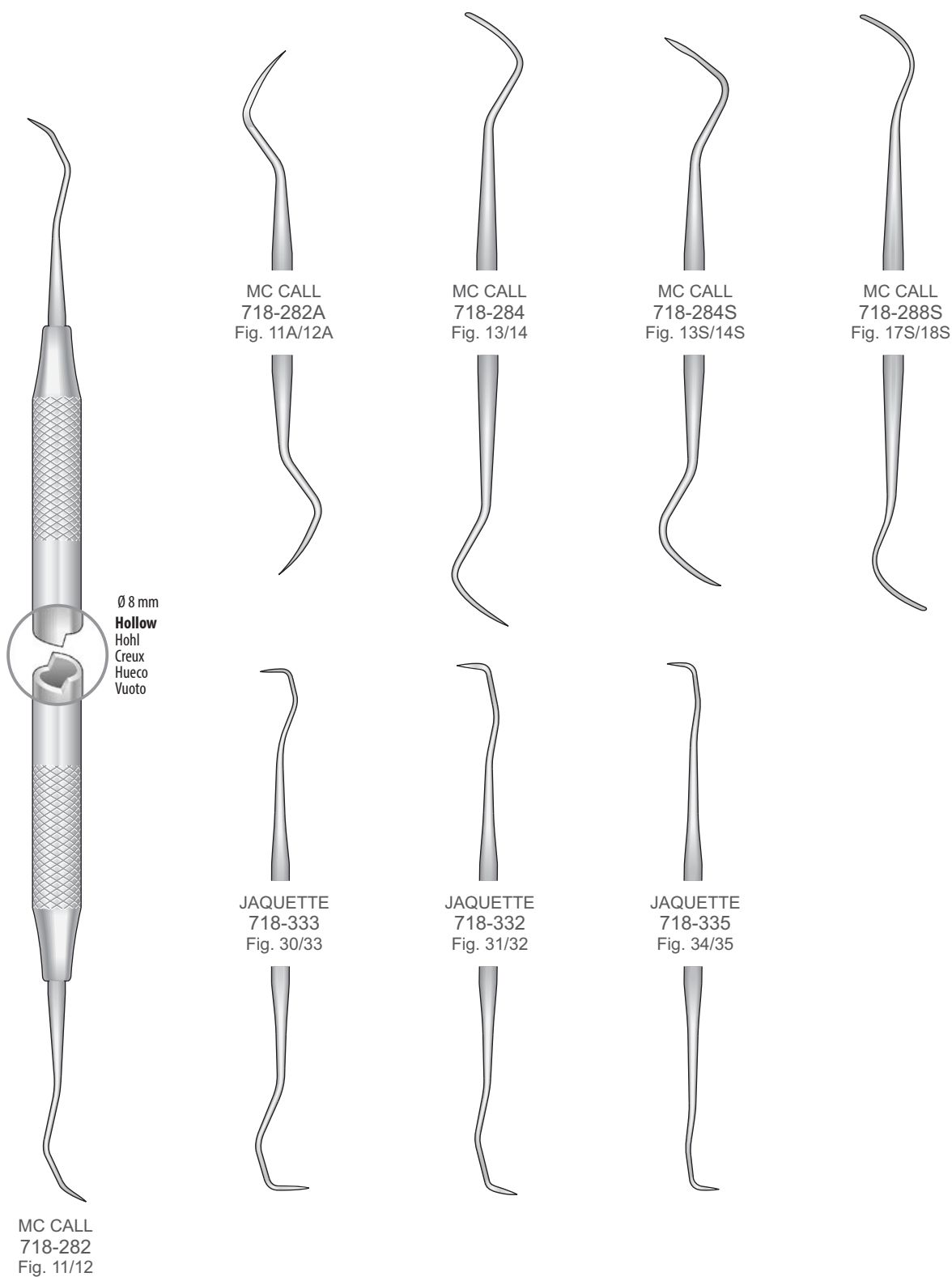

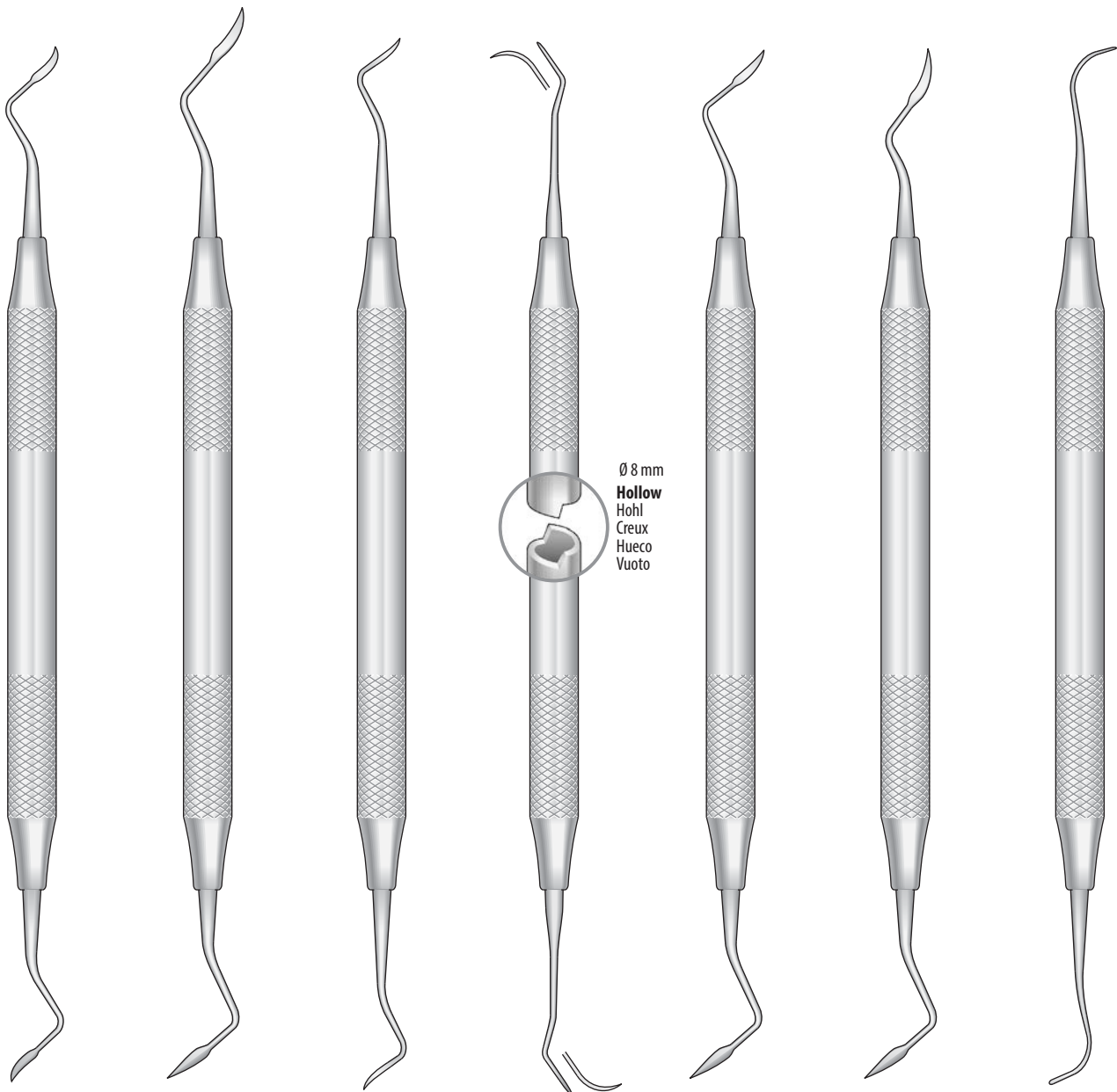

Ø 8 mm
Hollow
Hohl
Creux
Hueco
Vuoto

TAYLOR
718-TO3
Fig. 2/3

718-204
Fig. 204

718-204S
Fig. 204S

718-204SD
Fig. 204SD

718-CIO3
Fig. 2/3

CRANE-CAPLAN
718-CK6
Fig. 6

YOUNGER-GOOD
718-YGO8
Fig. 7/8



Scaler und Küretten
Scalers and Curettes
Scaler e Curette
Raspadores y Curetas
Détartreurs et Curettes

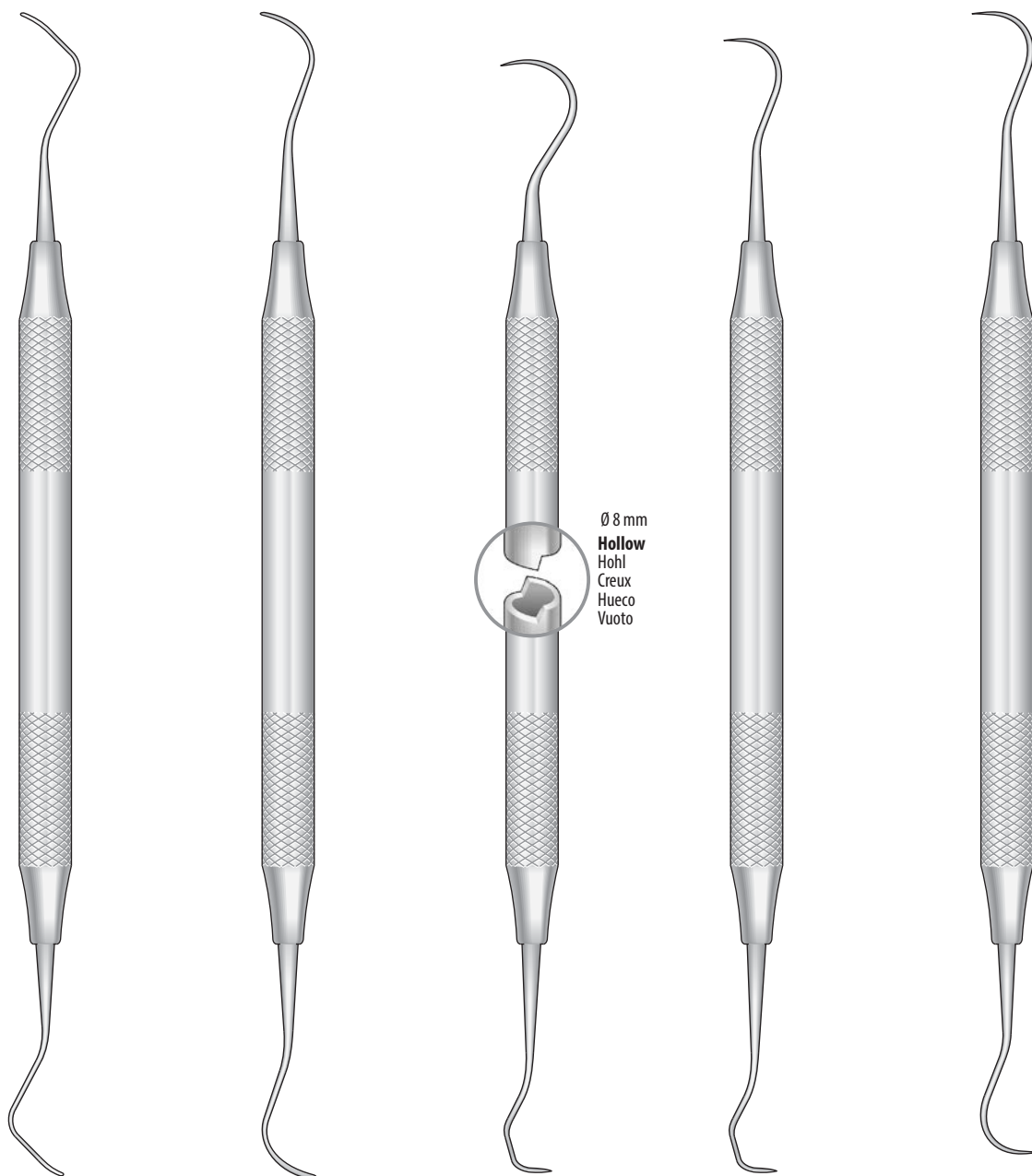

RULE 23/24
718-RO4
Fig. 3 /4

I. UNIVERSITY
718-268
Fig. 17/18

TOWNER-JAQUETTE
719-111
Fig. U15/33

TOWNER-JAQUETTE
719-125
Fig. H5/33

TOWNER-JAQUETTE
719-126
Fig. H6/H7

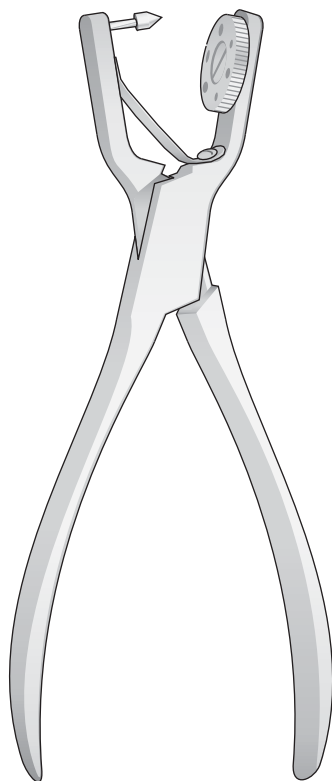

AINSWORTH
DF-02
160 mm

Lochzangen
Punch Forceps
Pinze foradiga
Perforadores
Pincas à perforer



DF-02M
Feder mit Schraube
Spring with screw
Molla con vite
Muelle con tornillo
Ressort avec vis



DF-02R
Lochscheibe
Punch Disk
Disco divisore
Disco agujereado
Disque perforé



DF-02P
Stift, mit Schraube
Pin, with screw
Perno con vite
Punzòn con perno
Broche

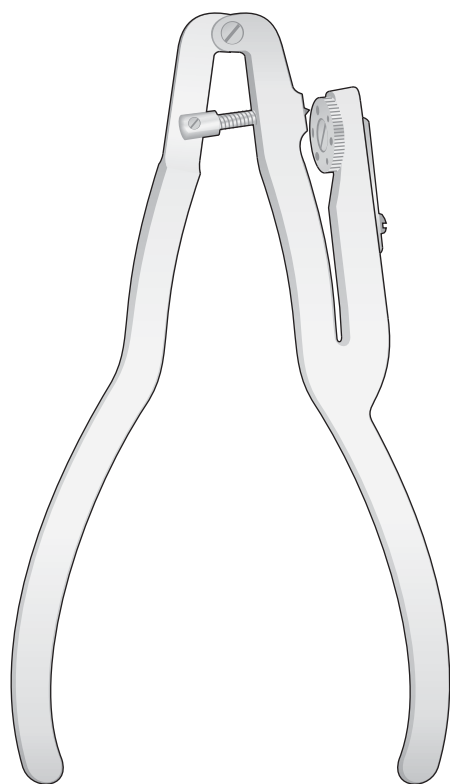

IVORY
DF-00
160 mm

Lochzangen
Punch Forceps
Pinze foradiga
Perforadores
Pincas à perforer



DF-00M
Spiralfeder
Spiral Spring
Molla a spirale
Muelle espiral
Ressort en spirale



DF-00L + DF-00V
Feder mit Schraube
Spring with screw
Molla con vite
Muelle con tornillo
Ressort avec vis



DF-00R
Lochscheibe
Punch Disk
Disco divisore
Disco agujereado
Disque perforé



DF-00P + DF-00N
Stift, mit Schraube
Pin, with screw
Perno con vite
Punzòn con perno
Broche avec vis



Kofferdam-Klammerzangen
Rubber-Dam Clamp Forceps
Pinze per uncini
Pinzas para grapas dique de goma
Pinces porte-crampons

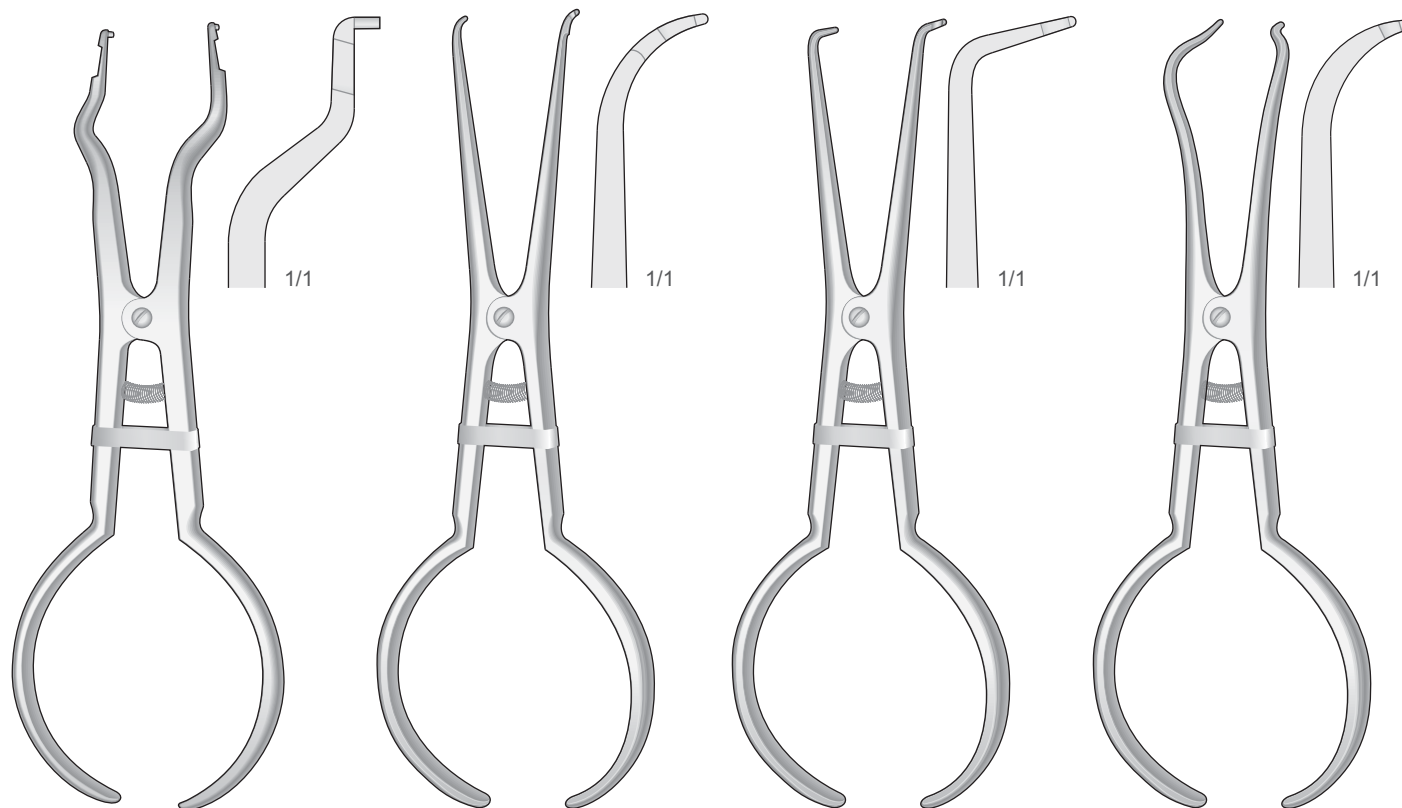

BREWER
DF-10
170 mm

PALMER
DF-15
170 mm

STOKE
DF-16
170 mm

DF-18
170 mm

Molaren, 12 Stück
Molars, 12 pieces
Molari, 12 pezzi
Molares, 12 piezas
Molaires, 12 Pièces

Premolaren, 12 Stück
Premolars, 12 pieces
Premolari, 12 pezzi
Premolares, 12 piezas
Prémolaires, 12 Pièces



DF-40/1
Fig.1



DF-41/4
Fig.4



DF-40/2
Fig.2



DF-41/5
Fig.5



DF-40/3
Fig.3



DF-41/6
Fig.6

Kofferdam-Klammerzangen
Rubber-Dam Clamp Forceps
Pinze per uncini
Pinzas para grapas dique de goma
Pincas porte-crampons

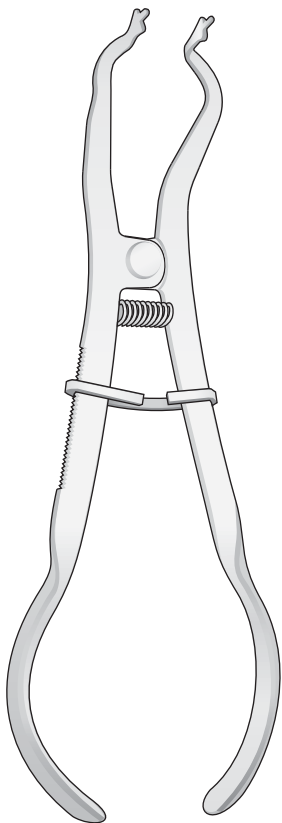

IVORY
DF-12
170 mm

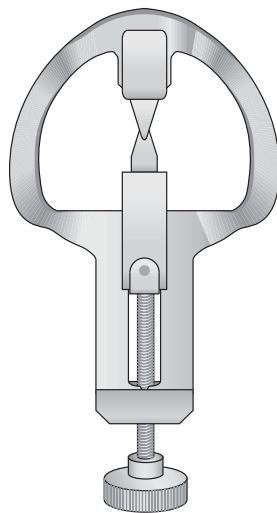

IVORY
DF-43
Fig. 14

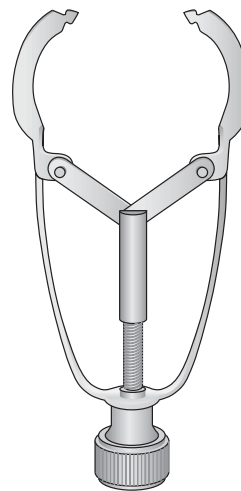

IVORY
DF-40
Fig. 1

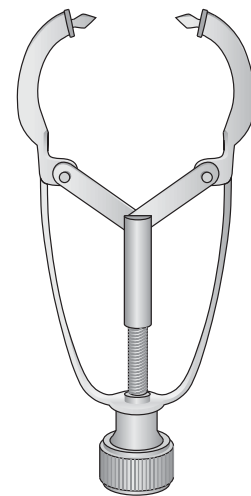

IVORY
DF-41
Fig. 12



Kofferdam Instrumente
Rubber-Dam Instruments
Strumenti per diga
Instrumentos para dique de goma
Instruments pour digue de caoutchouc

Kofferdam-Klammern
Rubber-Dam Clamps
Uncini per diga
Clamps para diques
Crampons pour digue



IVORY
DF-126
26



IVORY
DF-127
27



IVORY
DF-128
28



IVORY
DF-129
29



IVORY
DF-130
30



IVORY
DF-131
31



IVORY
DF-151
51



IVORY
DF-160
60

Kofferdam-Rahmen
Rubber-Dam Frames
Telaio per diga
Cuadro para diques
Cadre à digue

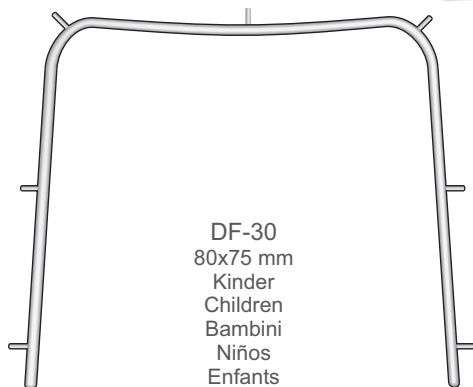

DF-30
80x75 mm
Kinder
Children
Bambini
Niños
Enfants

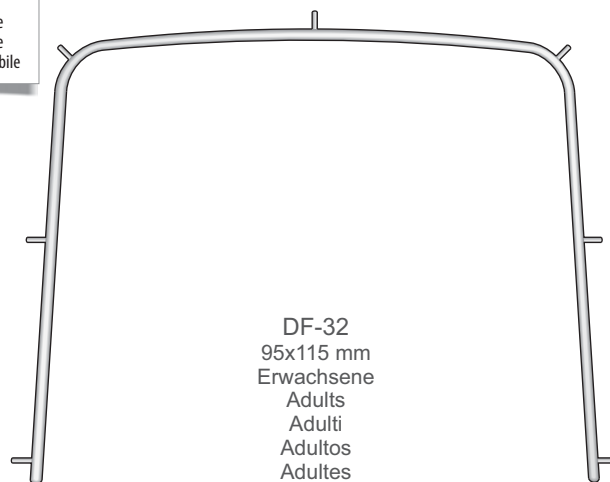

DF-32
95x115 mm
Erwachsene
Adults
Adulti
Adultos
Adultes

Molaren, 12 Stück
Molars, 12 pieces
Molari, 12 pezzi
Molares, 12 piezas
Molaires, 12 Pièces

Premolaren, 12 Stück
Premolars, 12 pieces
Premolari, 12 pezzi
Premolares, 12 piezas
Prémolaires, 12 Pièces

TOFFLEMIRE
Universal



DF-03/7
#7



DF-03/11
#11



DF-03/1
#1



DF-03/8
#8

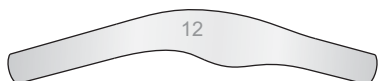

DF-03/12
#12



DF-03/2
#2



DF-03/9
#9



DF-03/13
#13



DF-03/3
#3



DF-03/10
#10



DF-01/5 5 mm x 1 mt
DF-01/6 6 mm x 1 mt
DF-01/7 7 mm x 1 mt



DF-05/5 5 mm x 5 mt
DF-05/6 6 mm x 5 mt
DF-05/7 7 mm x 5 mt

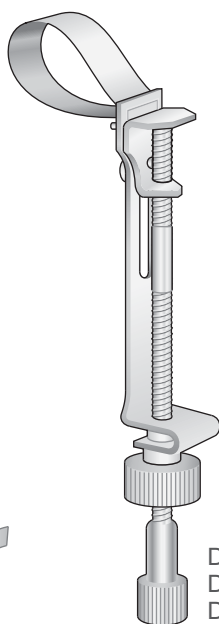

IVORY
DF-06/DF-09
#8

DF-06 5 mm
DF-08 6 mm
DF-09 7 mm

Paar - Pair
Coppia - Par
Paire



#1
Rechts
Right
Destra
Derecha
Droite



#2
Links
Left
Sinistra
Izquierda
Gauche

NYSTRÖM
DF-04
#1 + #2



TOFFLEMIRE
DF-07
Universal

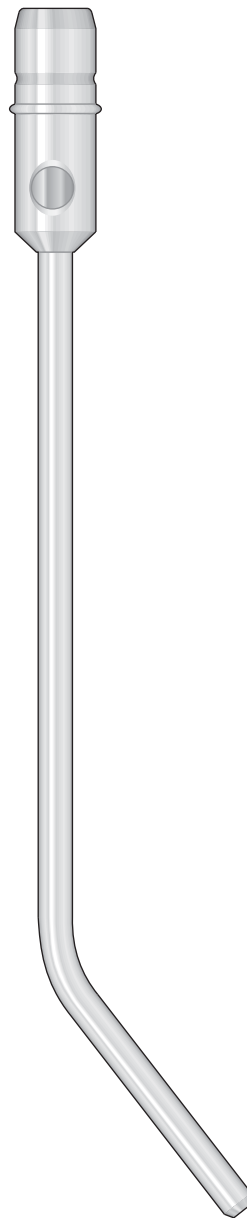

12 |

Suction Tubes

Saugkanülen

Canules d'aspiration

Cánulas de aspiración

Cannule per aspirazione



Saugkanülen
Suction Tubes
Cannule per aspirazione
Cánulas de aspiración
Canules d'aspiration

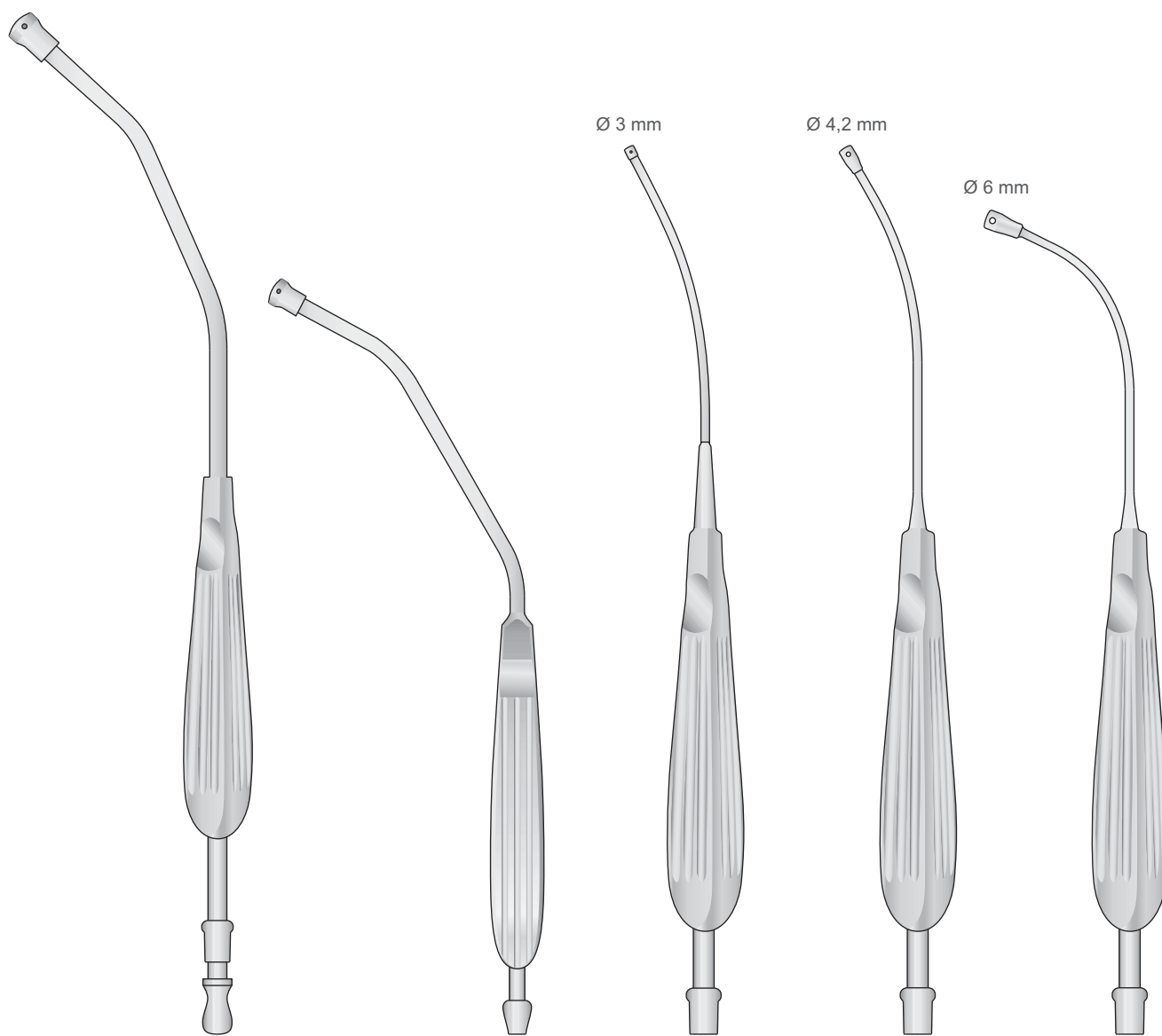

YANKAUER
GF-12
310 mm

BABY-YANKAUER
GF-10
200 mm

ANDREWS-PYNCHON
GF-06
250 mm

ANDREWS-PYNCHON
GF-07
250 mm

ANDREWS-PYNCHON
GF-54
230 mm

12



Saugkanülen
Suction Tubes
Cannule per aspirazione
Cánulas de aspiración
Canules d'aspiration

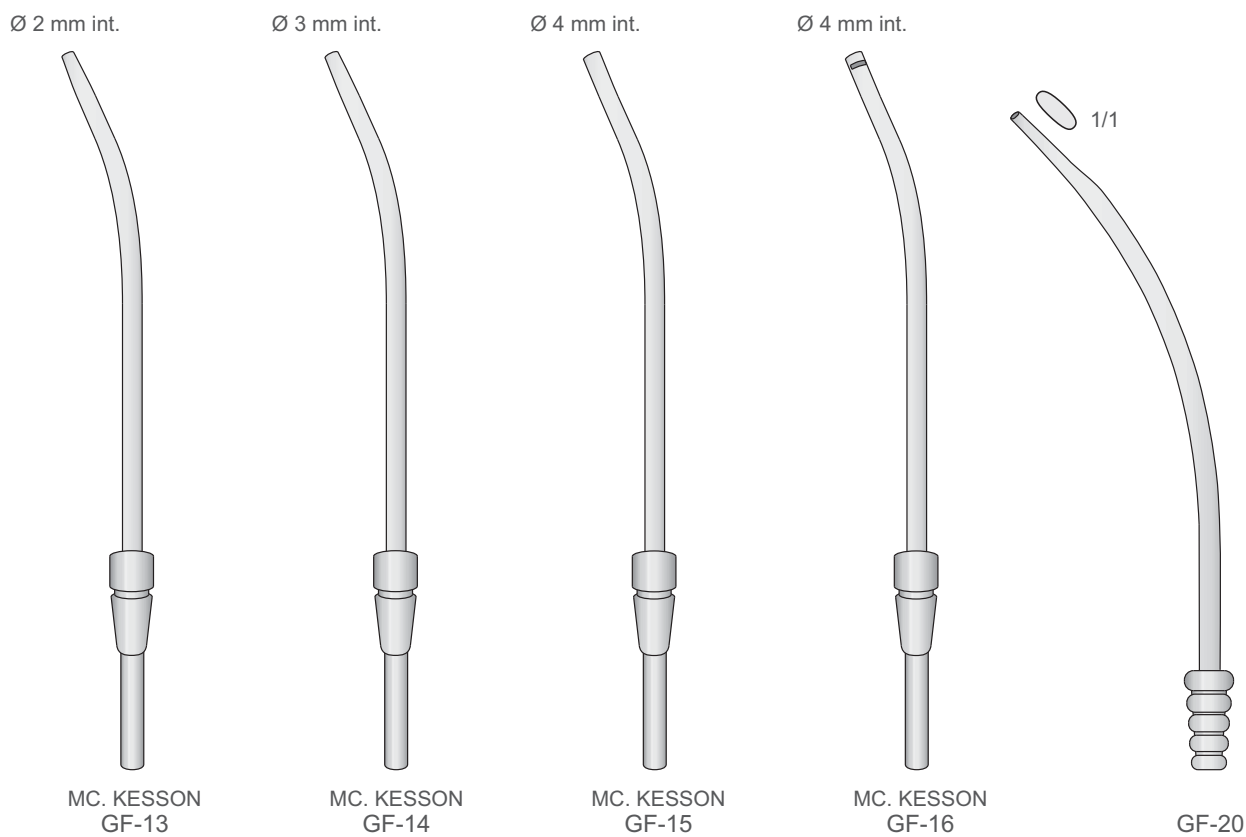
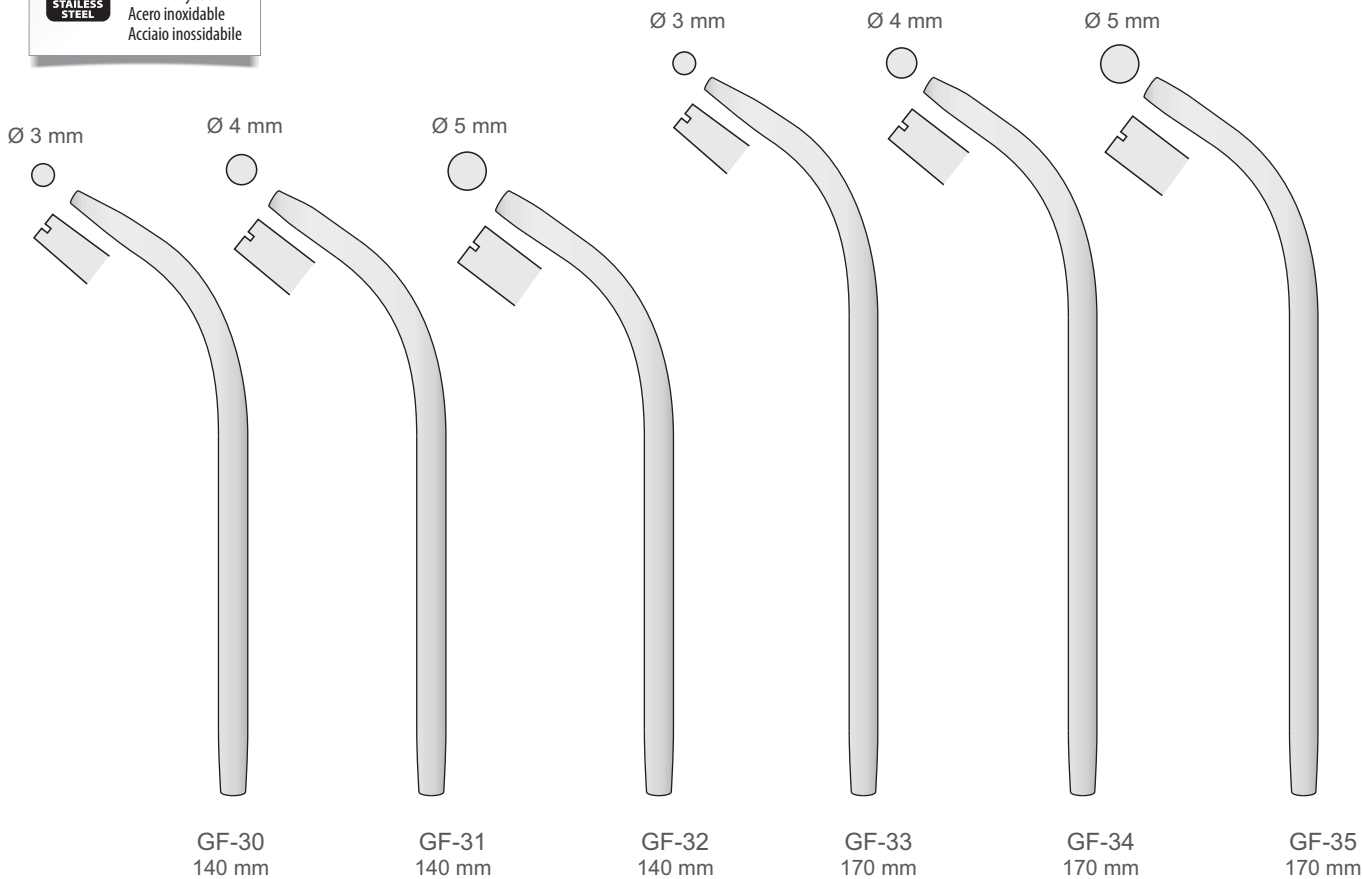



Saugkanülen
Suction Tubes
Cannule per aspirazione
Cánulas de aspiración
Canules d'aspiration

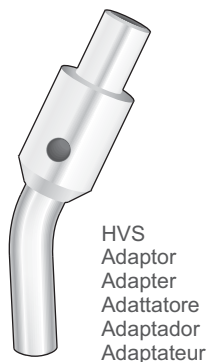

HVS
Adaptor
Adapter
Adattatore
Adaptador
Adaptateur

TS-40

Connection piece for suction
75 mm - 100% Stainless Steel



COUPLAND
GF-01
150 mm

Ø 1 mm



GF-05
95 mm

Ø 1,5 mm

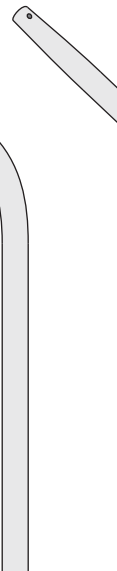

GF-04
95 mm

Ø 2,5 mm

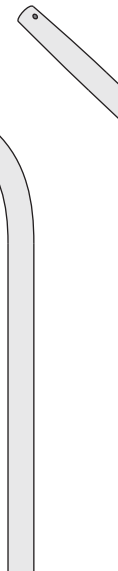

GF-03
95 mm

Ø 3,5 mm int.

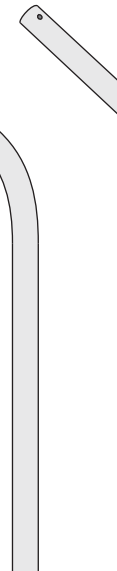

GF-02
95 mm



GF-271
56 mm

Adaptor
Adapter
Adattatore
Adaptador
Adaptateur

Ø Ext. 6,0 mm
Ø Int. 4,5 mm

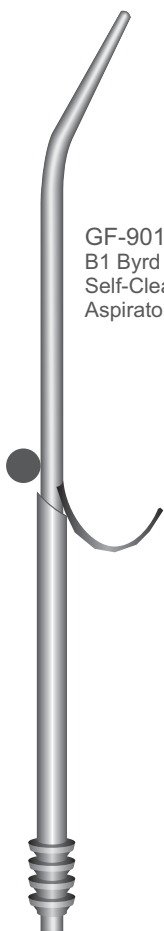

GF-901
B1 Byrd
Self-Cleaning
Aspirator

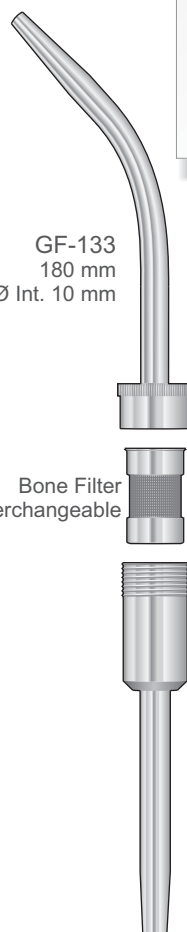

GF-133
180 mm
Ø Int. 10 mm

Bone Filter
interchangeable

COMPLETE SET
GF-11
(GF-01 + GF-02 + GF-03 + GF-04 + GF-05)
Griff + 4 Kanülen
Handle + 4 tubes
Manico + 4 cannule
Mango + 4 cánulas
Manche + 4 canules



Ø Est. 8 mm
Ø Int. 6 mm



1/1

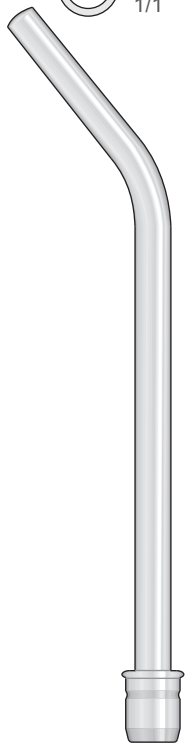

PELTON-CRANE
GF-184
140 mm

Ø Est. 5 mm
Ø Int. 2,5 mm



1/1

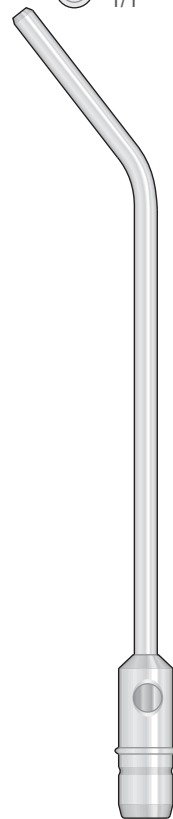

PELTON-CRANE
GF-180
160 mm

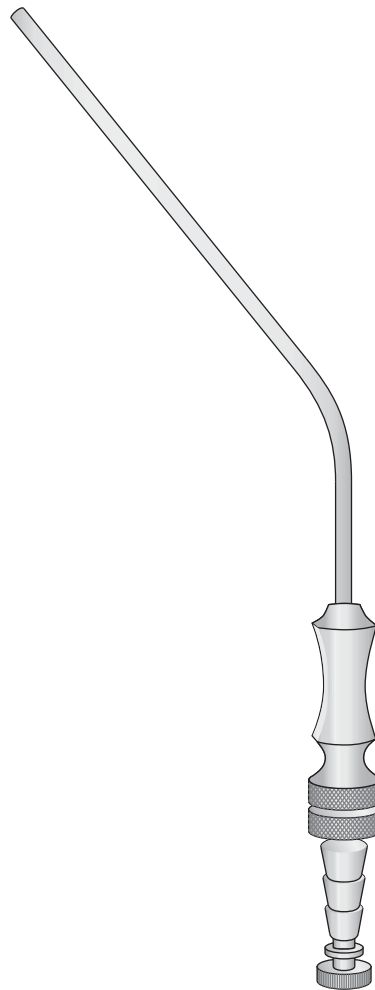

FRAZIER
GF-240/GF-244
180 mm

GF-240	Ch. 6	2.0 mm
GF-241	Ch. 7	2.3 mm
GF-241B	Ch. 8	2.5 mm
GF-242	Ch. 9	3.0 mm
GF-242B	Ch. 10	3.3 mm
GF-243	Ch. 12	4.0 mm
GF-244	Ch. 15	5.0 mm



Saugkanülen
Suction Tubes
Cannule per aspirazione
Cánulas de aspiración
Canules d'aspiration



Flexible
Flexibel
Flexible
Flexible
Flessibile
Ø 3 mm

WERTHEIMER
GF-69
160 mm

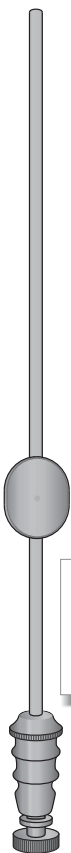

FRAZIER
GF-70
160 mm

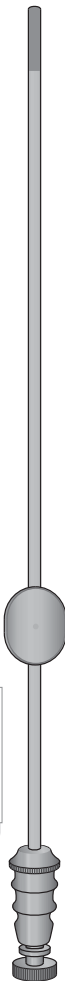

Flexible
Flexibel
Flexible
Flexible
Flessibile
Ø 3 mm

FRAZIER
GF-61
200 mm

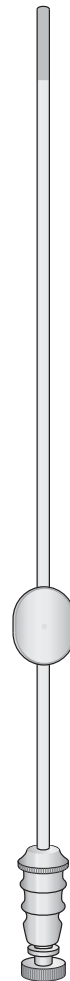

WERTHEIMER
GF-60
200 mm

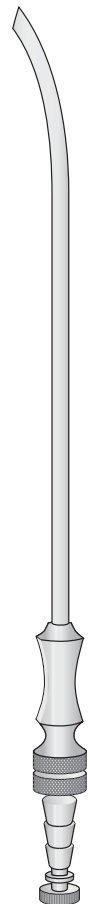

ADSON
GF-41 ch. 12 Ø 4 mm
GF-42 ch. 15 Ø 5 mm
210 mm

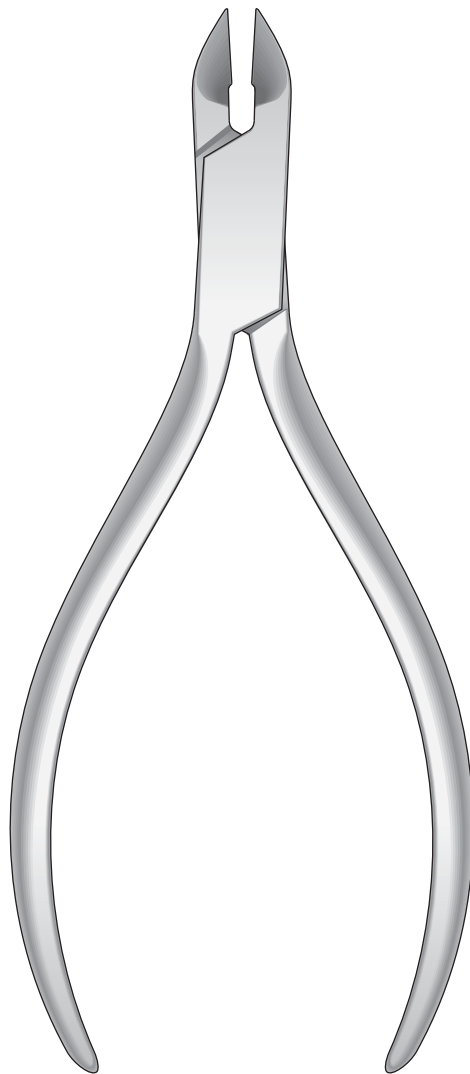

13 |

Orthodontics
Kieferorthopädie
Orthodontie
Ortodoncia
Ortodonzia



Drahtbiegezaugen
Wire Bending Pliers
Pinze per piegare fili
Alicates para doblar alambres
Pincès à pliers les fils

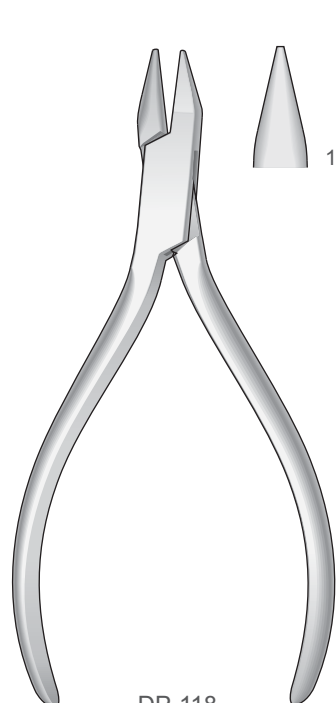

DP-118
130 mm

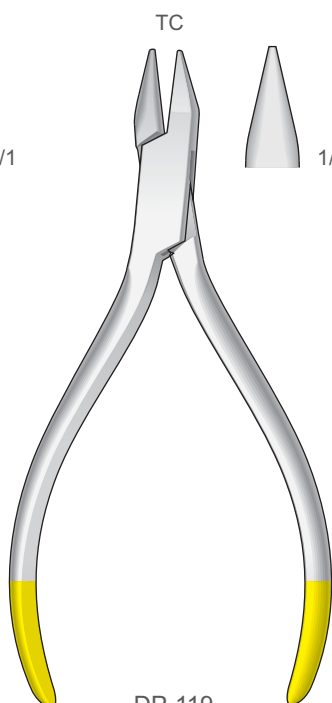
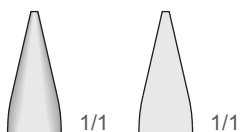

DP-119
130 mm

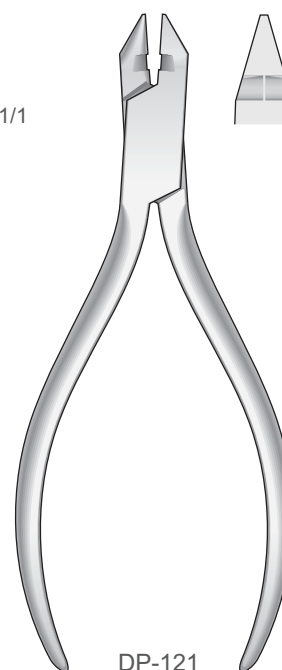
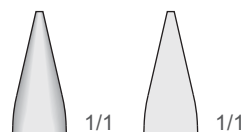

DP-121
130 mm

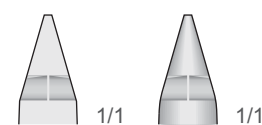

TC
TUNGSTEN
CARBIDE
Tungsten-Carbide Inserts
Mit Hartmetalleinsätzen
Plaquettes en carbure de tungstène
Plaquetas de carburo de tungsteno
Inserti in carburo di tungsteno

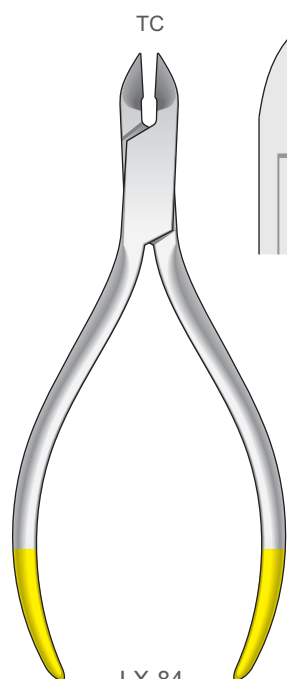

LX-84
125 mm

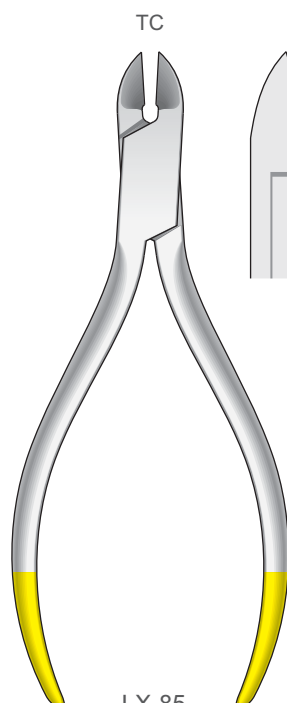
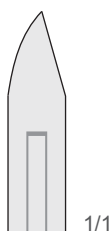

LX-85
130 mm

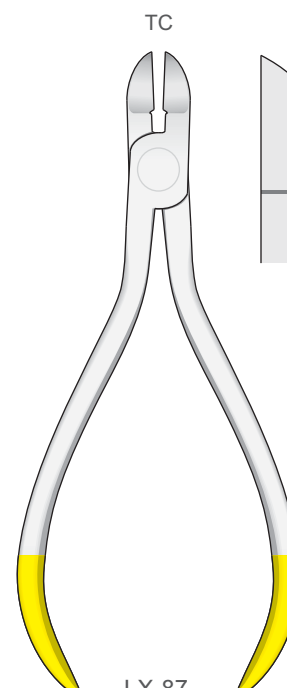
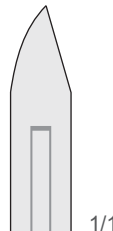

LX-87
125 mm

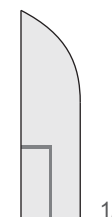

Drahtbiegezeugen
Wire Bending Pliers
Pinze per piegare fili
Alicates para doblar alambres
Pincès à pliers les fils

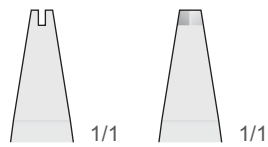
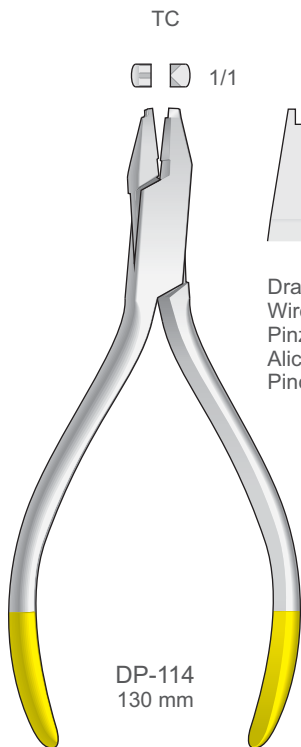

Drahtbiegezeugen
Wire Bending Pliers
Pinze per piegare fili
Alicates para doblar alambres
Pincès à pliers les fils

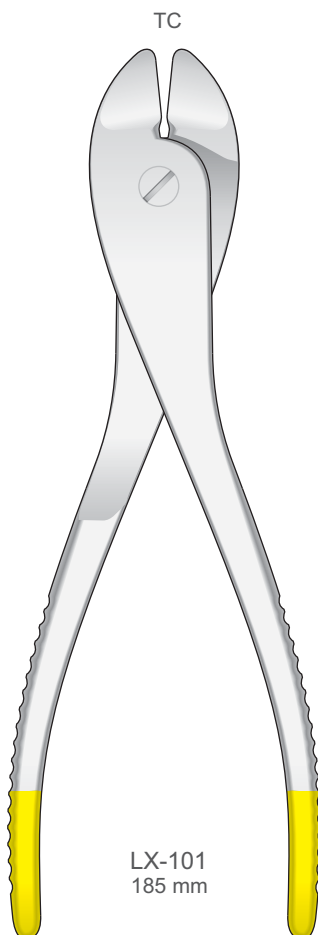
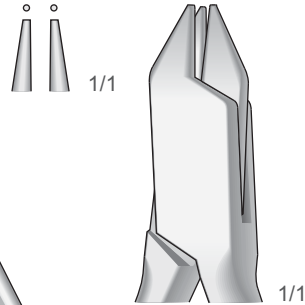
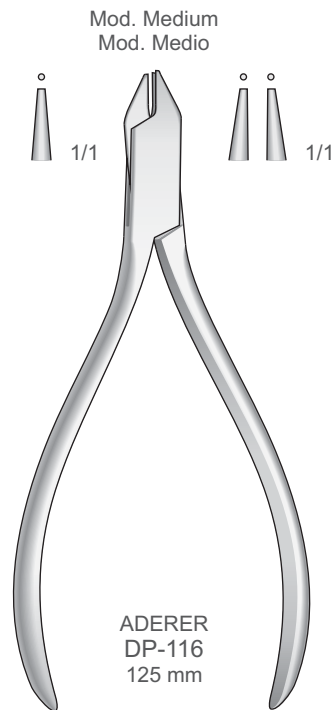

TC
TUNGSTEN
CARBIDE

Tungsten-Carbide Inserts
Mit Hartmetalleinsätzen
Plaquettes en carbure de tungstène
Plaquetas de carburo de tungsteno
Inserti in carburo di tungsteno

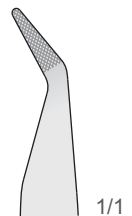
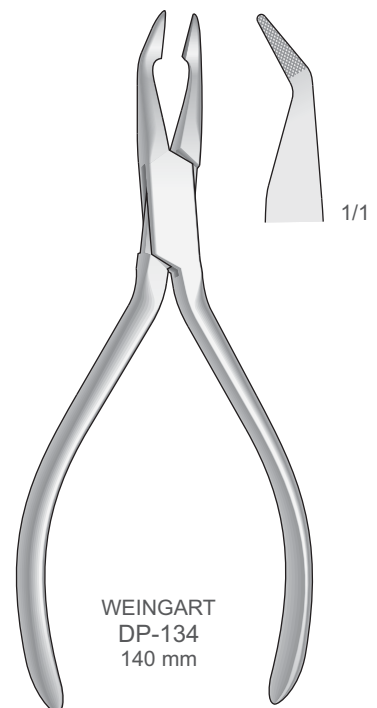
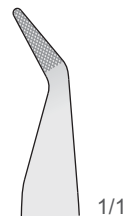
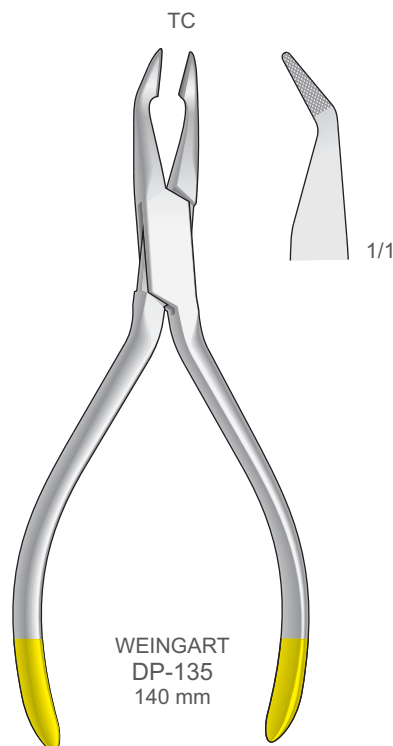



Drahtschneidezangen
Wire cutting pliers
Tronchesi per fili metallici
Alicates para cortar alambre
Pinces à couper les fils

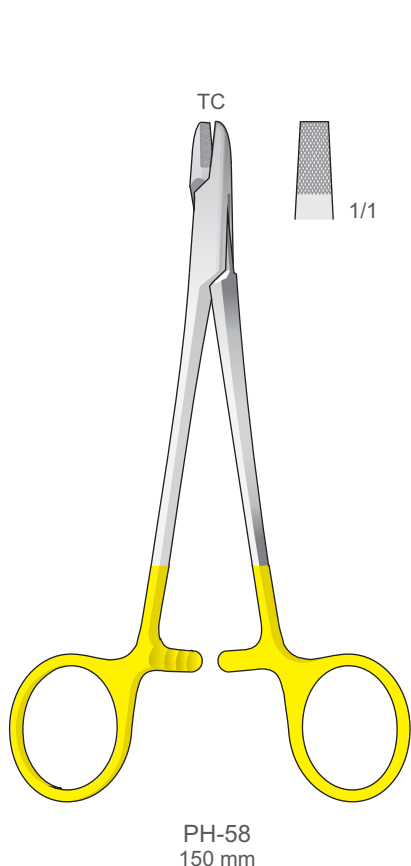

PH-58
150 mm

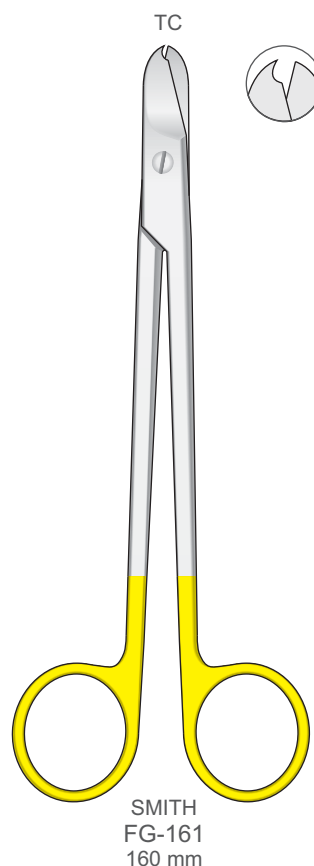

SMITH
FG-161
160 mm

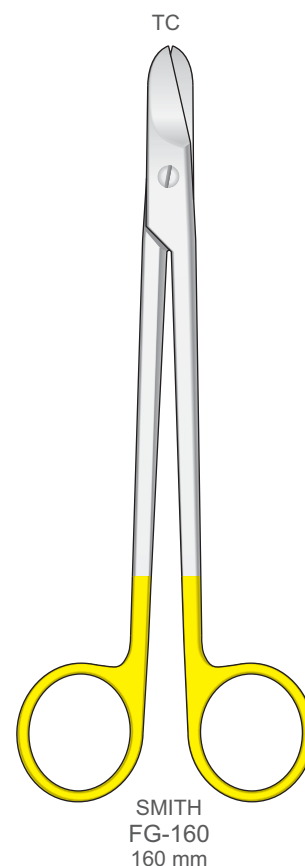

SMITH
FG-160
160 mm

TC
TUNGSTEN
CARBIDE
Tungsten-Carbide Inserts
Mit Hartmetalleinsätzen
Plaquettes en carbure de tungstène
Plaquetas de carburo de tungsteno
Inserti in carburo di tungsteno

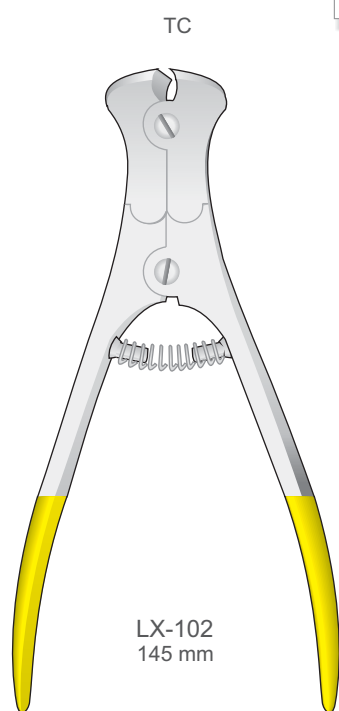

LX-102
145 mm

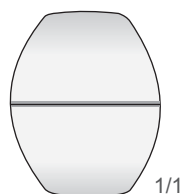

1/1

○ Max Ø 2.0 mm (.078")

Für weichen Draht
For soft Wire
Per filo leggero
Para alambre blando
Pour fil léger

○ Max Ø 1.5 mm (.059")

Für harten Draht
For hard Wire
Per filo duro
Para alambre duro
Pour fil dur

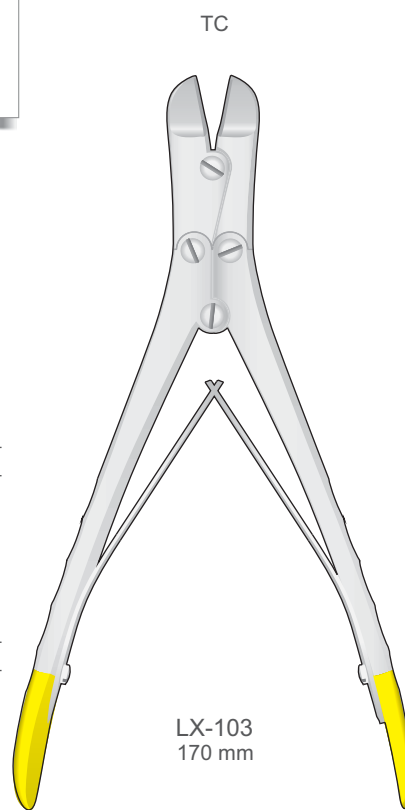

LX-103
170 mm

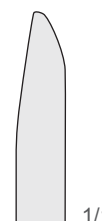

1/1

○ Max Ø 2.0 mm (.078")

Für weichen Draht
For soft Wire
Per filo leggero
Para alambre blando
Pour fil léger

○ Max Ø 1.5 mm (.059")

Für harten Draht
For hard Wire
Per filo duro
Para alambre duro
Pour fil dur

Scheren für dünne Stahl-und Edelmetallbleche - Scissors for thin steel and precious metal sheets
Forbici per lamine sottili di acciaio e metalli preziosi - Tijeras para láminas delgadas de acero y metales preciosos
Ciseaux pour couper les feuilles de métaux

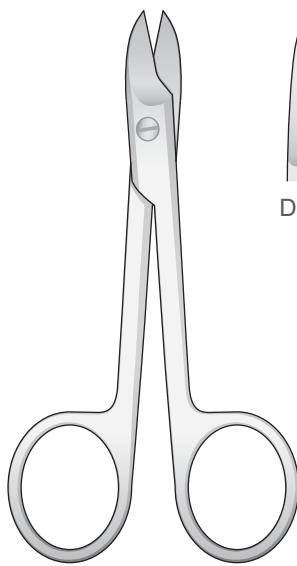

BEEBE
DP-91/DP-92
110 mm

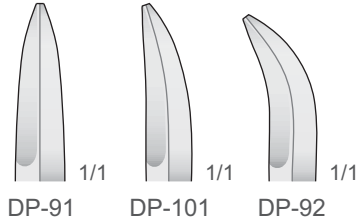

Spitz
Sharp
Acute
Aguda
Pointu

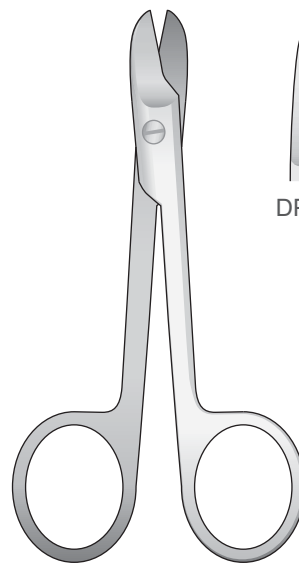

BEEBE
DP-102/DP-103
110 mm

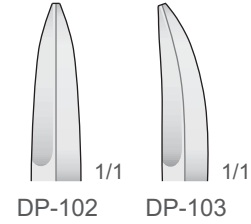

Stumpf
Blunt
Smusse
Roma
Mousse

Scheren für dünne Stahl-und Edelmetallbleche - Scissors for thin steel and precious metal sheets
Forbici per lamine sottili di acciaio e metalli preziosi - Tijeras para láminas delgadas de acero y metales preciosos
Ciseaux pour couper les feuilles de métaux

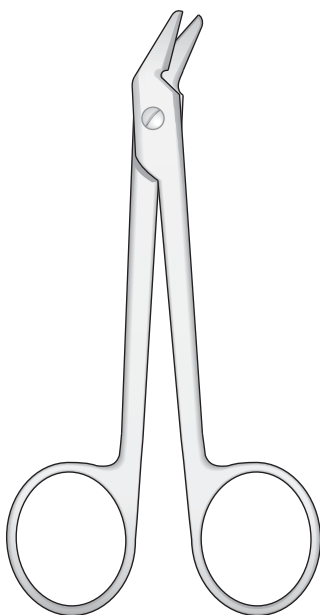

DP-90
120 mm

Draht-und Blechschere gezahnt
Wire cutting scissor serrated
Forbice universale dentellata
Tijeras para cortar hilo
de acero dentadas
Coupe-fils dentelé

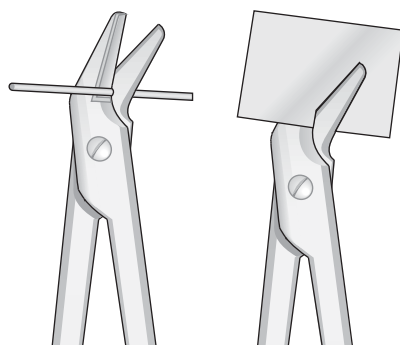

DP-120
120 mm

○ Max Ø 1.2 mm (.048")

Für weichen Draht
For soft Wire
Per filo leggero
Para alambre blando
Pour fil léger



Tungsten-Carbide Inserts
Mit Hartmetalleinsätzen
Plaquettes en carbure de tungstène
Plaquetas de carburo de tungsteno
Inserti in carburo di tungsteno



Separierzangen
Separating Pliers
Pinze tendielastici
Pinza estira-elásticos
Pince à separer

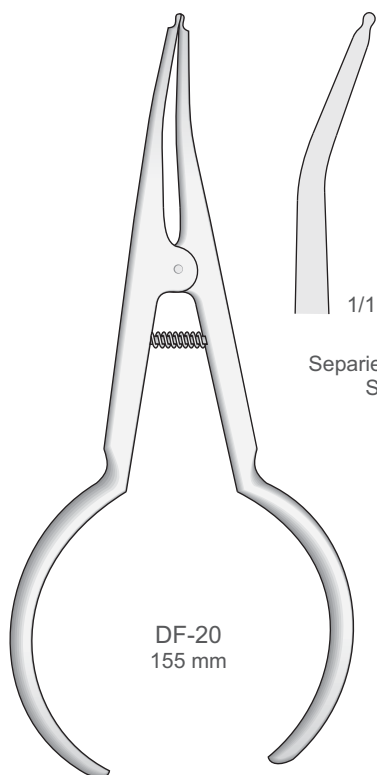

DF-20
155 mm

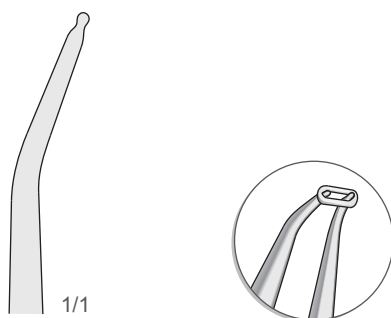

Separierzange, zum Einbringen von Gummi-Separierligaturen
Separating forceps for inserting elastic separators
Pinza per legature per separatori elastici
Pinza para ligaduras estira-elásticos
Pince à separer les ligatures

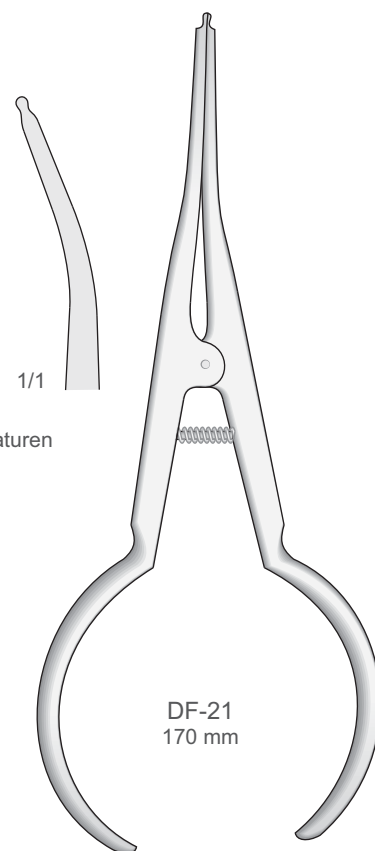

DF-21
170 mm

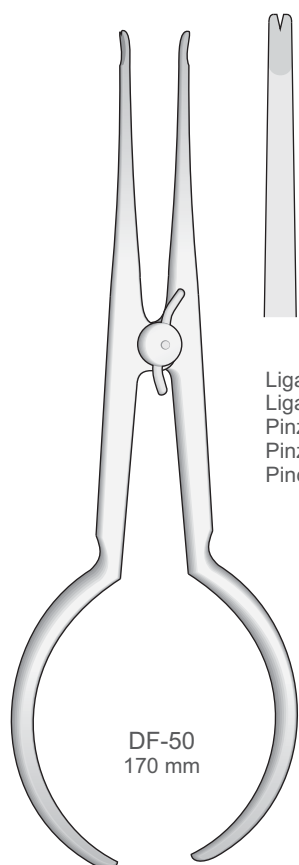

DF-50
170 mm

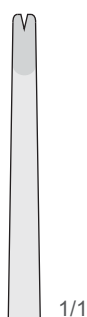

Ligaturenspannzange
Ligature Tying Plier
Pinza per legature
Pinza para ligaduras
Pince à serrer les ligatures



DP-150
160 mm

Bracketset Pinzette
Bonding Bracket Forceps
Pinzette per brackets
Pinza fina para ligar brackets
Fine pince à lier des boîtiers

5.0
4.0
0 -



DP-100
170 mm

Bracketpositioner
Bracket Positioning Gauge
Posizionatore per attacchi
Posicionador de Brackets
Positionateur des Brackets

Aluminium
Aluminium
Aluminium
Aluminio
Alluminio

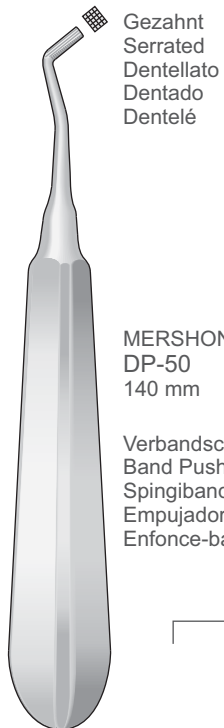

Gezahnt
Serrated
Dentellato
Dentado
Dentelé

MERSHON
DP-50
140 mm

Verbandschieber
Band Pusher
Spingibande
Empujador de bandas
Enfonce-bague

Ligaturen Instrumente
Ligating Instruments
Strumenti per legature
Instrumentos para ligaduras
Instruments pour ligatures

DP-100
170 mm



SHURE
DP-124
175 mm

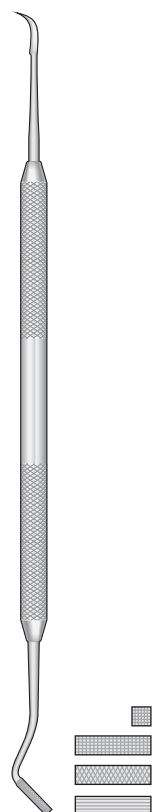

DP-54
175 mm

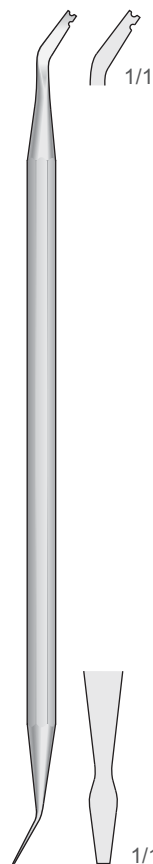

DP-125
155 mm

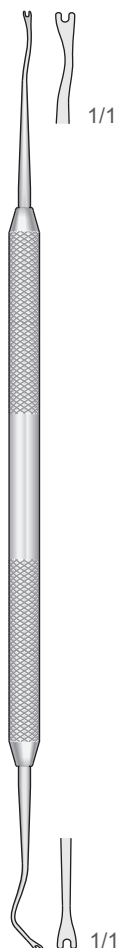

PF-1
170 mm

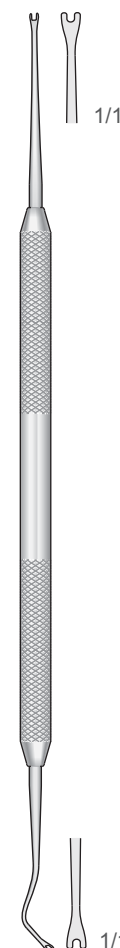

PF-2
170 mm



PF-3
160 mm



Ligaturen Instrumente
Ligating Instruments
Strumenti per legature
Instrumentos para ligaduras
Instruments pour ligatures

13

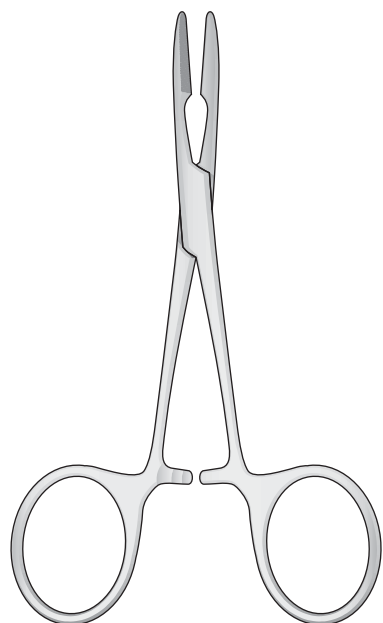

PEAN-MURPHY
BF-22
130 mm

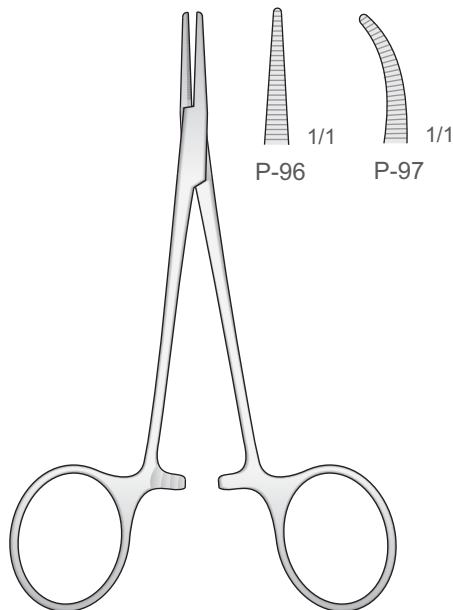

HALSTED-MOSQUITO
P-96/P-97
120 mm



COLLEGE
150 mm



MILLER
DR-78
145 mm

Bracketset Pinzette - Forceps for positioning brackets
Pinzette per riposizionare gli attacchi diretti
(posizionamento dei bracket)
Pinza para colocar brackets - Précelle pour positionner les brackets

Bracket Gauge
Stainless Steel

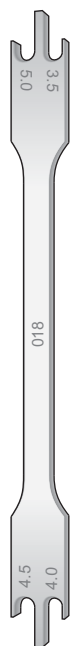

DP-132
130 mm



DP-133
130 mm



DP-52
130 mm



DP-126
110 mm

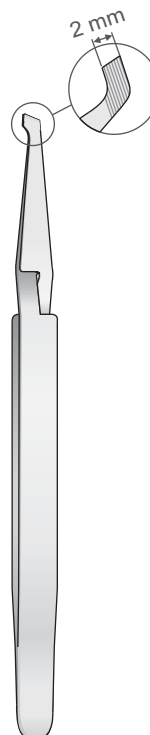

DP-127
125 mm



DP-128
145 mm

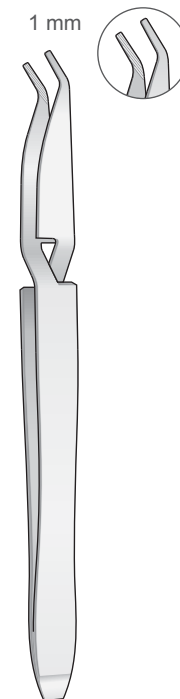

DP-129
130 mm

Dental-Schieblehre für Praxis und Labor
Gauge Caliper for practice and laboratory
Calibri dentali per studio e laboratorio
Calibrador dental para práctica y el laboratorio
Gauge calibreur pour practice et laboratoire

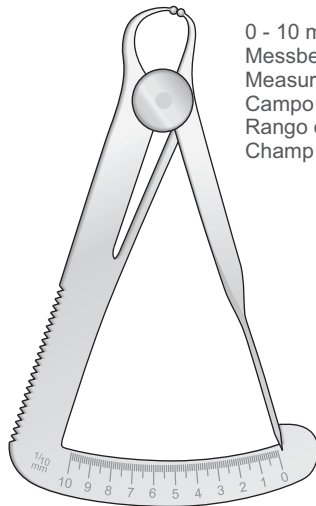

0 - 10 mm
Messbereich
Measuring range
Campo di misura
Rango de medición
Champ de mesure

IWANSON
DP-721
100 mm

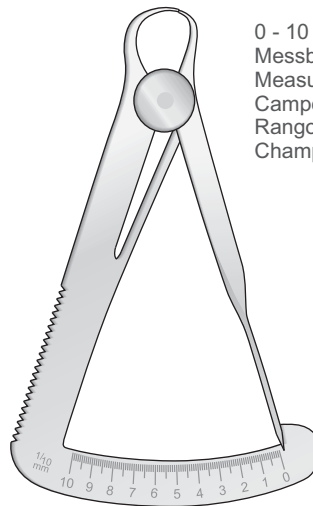

0 - 10 mm
Messbereich
Measuring range
Campo di misura
Rango de medición
Champ de mesure

IWANSON
DP-720
100 mm

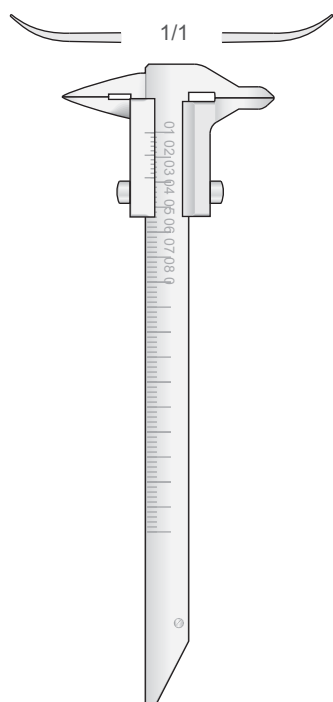

DP-723
80 mm

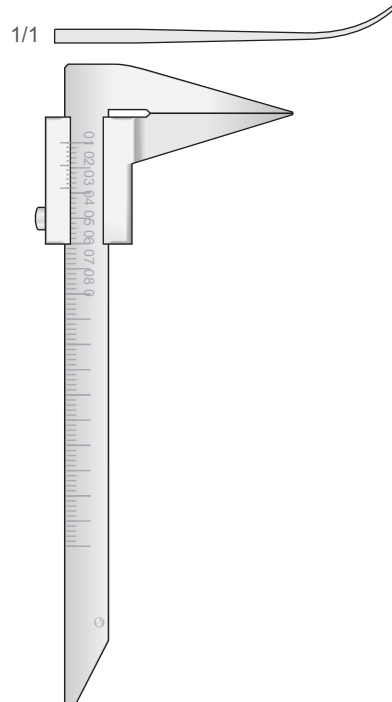

DP-724
80 mm

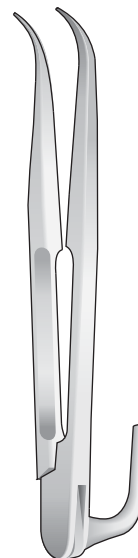

ZIELINSKY
DP-725
110 mm

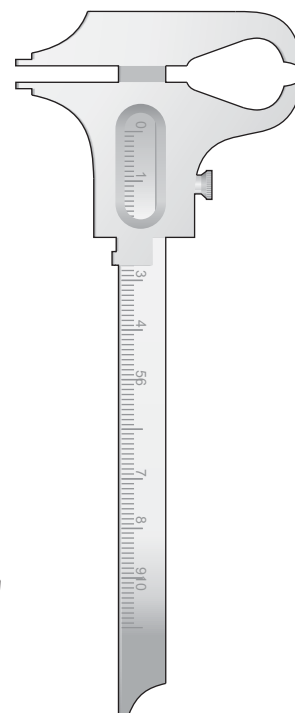

BOLEY
DP-730
140 mm

0 - 100 mm
Messbereich
Measuring range
Campo di misura
Rango de medición
Champ de mesure



Zubehör
Accessories
Accessori
Accesorios
Accessoires

13

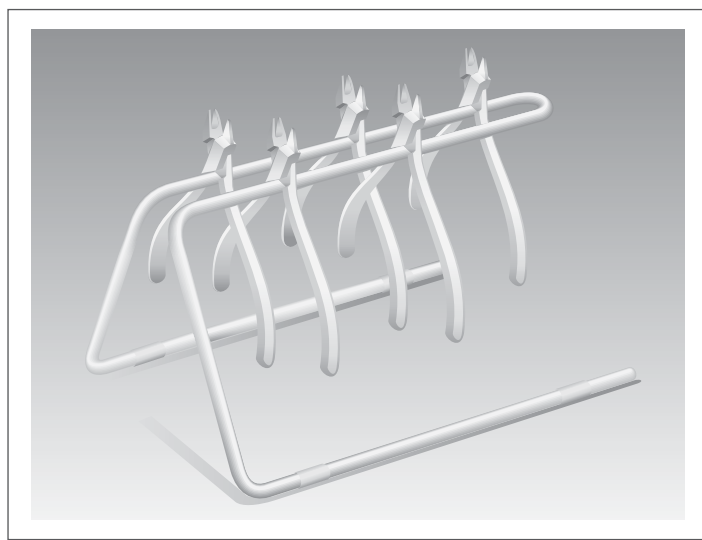

Zangenständer
Plier Stand
Supporto per pinze
Soportes para alicates
Supports de pinces

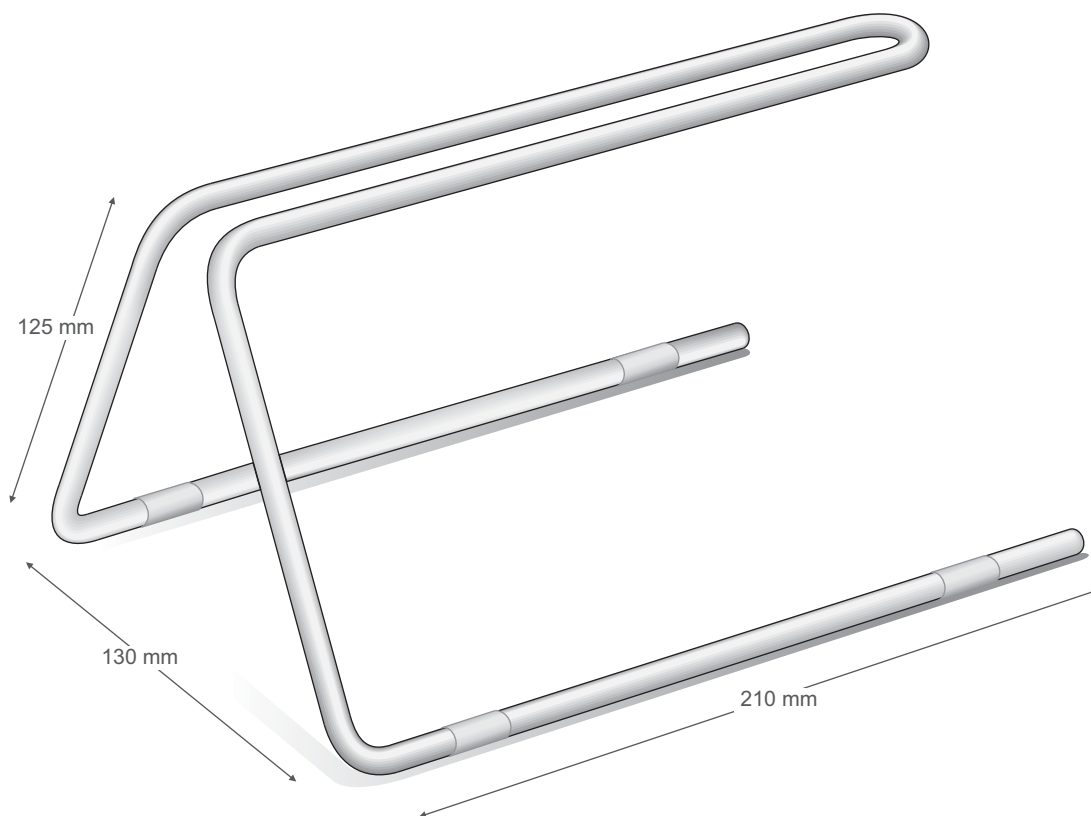

DP-140

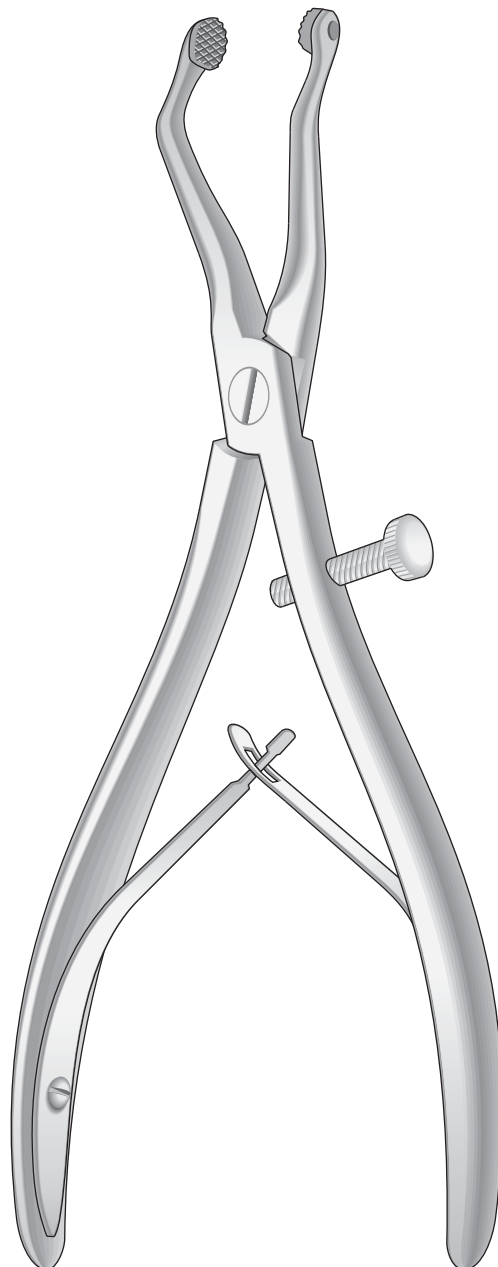

14 |

Crown Instruments

Kronenentferner
Enlève-couronne
Removedor de coronas
Leva corone

Laboratory

Laboratorium
Laboratoire
Laboratorio
Laboratorio



Kroneninstrumente
Crown Instruments
Pinze per corone
Alicates para coronas
Pinces pour couronnes

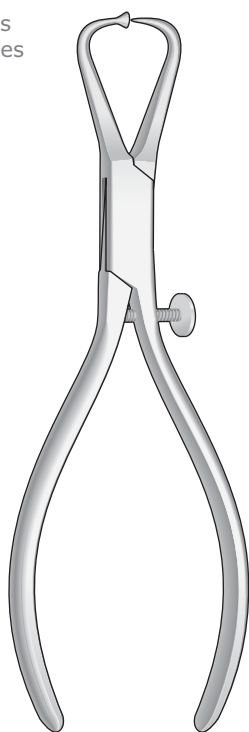

KERLING
DP-38A
145 mm

Kupferringabnehmezange
Copper Ring Removing Pliers
Pinza per togliere anelli di rame
Pinza para sacar anillos de cobre
Pince à enlever les bagues en cuivre

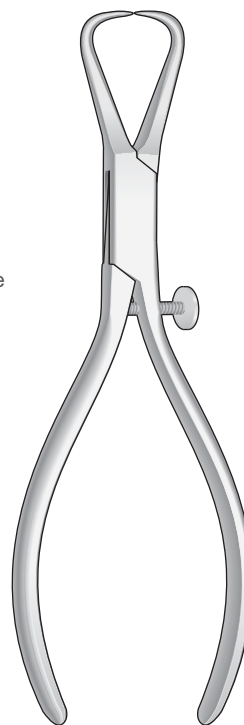

FURRER
DP-38
145 mm

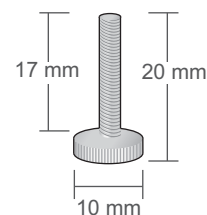

DP-38R
Schraube
Replacement Screw
Vite di ricambio
Tornillos de recambio
Vis de rechange

Teleskopkronenzangen - Pliers for telescope crowns
Pinze per corone telescopiche - Alicates para coronas telescópicas
Pinces pour couronnes telescopes

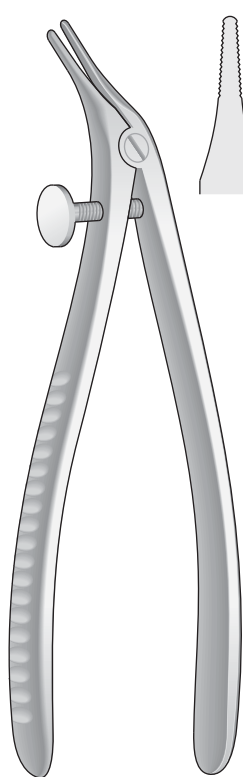

BÖHM
DP-28
150 mm

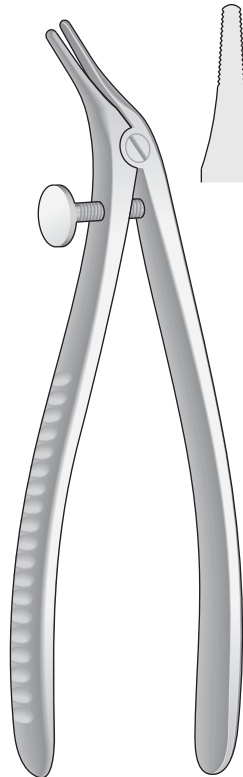
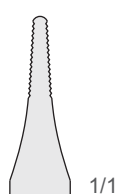

BÖHM
DP-29
150 mm

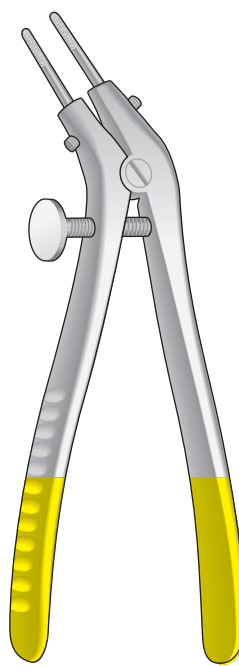
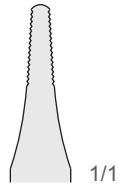

DP-24
120 mm



DP-24C
Schlüssel
Key
Chiavetta
Llave
Clé



DP-24R
Diamantierte Einsätze, paar
Diamond inserts, pairs
Punte diamantate, coppia
Puntas diamantadas, par
Pointes diamantées, pair

MRT/C7
BRIDGE-EXTRACTOR
COMPLETE SET
MRT-7 + C-71 + C-72 + C-73 + C-74

Removing pliers
for temporary
bridges and crowns

TC
TUNGSTEN
CARBIDE
Tungsten-Carbide Inserts
Mit Hartmetalleinsätzen
Plaquettes en carbure de tungstène
Plaquetas de carburo de tungsteno
Inserti in carburo di tungsteno

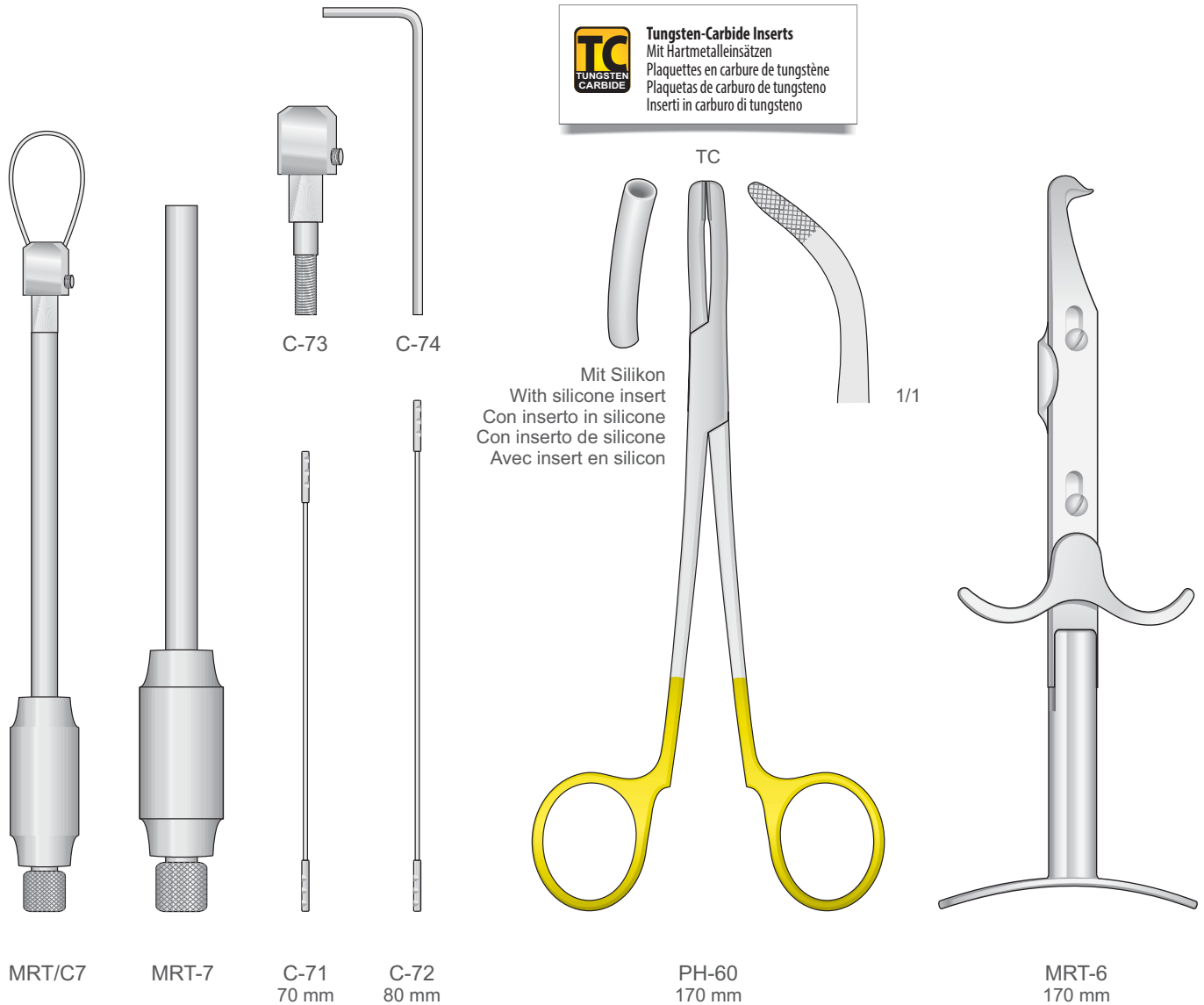



Kronentferner
Crown Removers
Leva corone
Removedor de coronas
Enlève-couronne

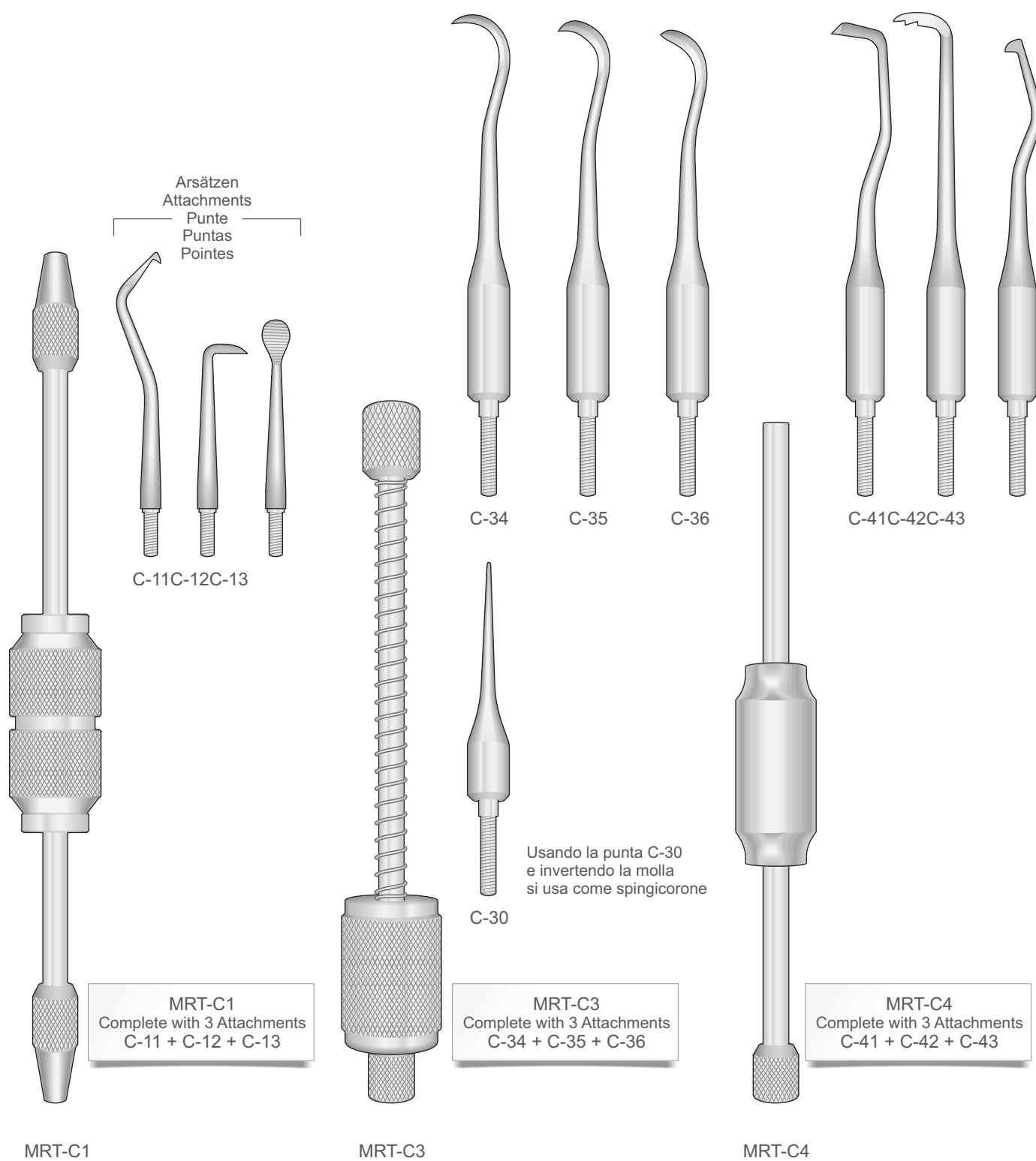



DL-C
140 mm



UNIVERSAL
DL-60
150 mm



DL-V
130 mm

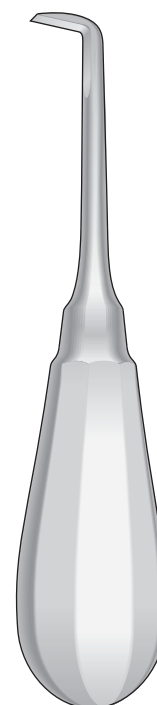

DL-0
130 mm



Wachsmesser
Wax Knives
Coltelli per cera
Cuchillos para cera
Couteaux à cire

14

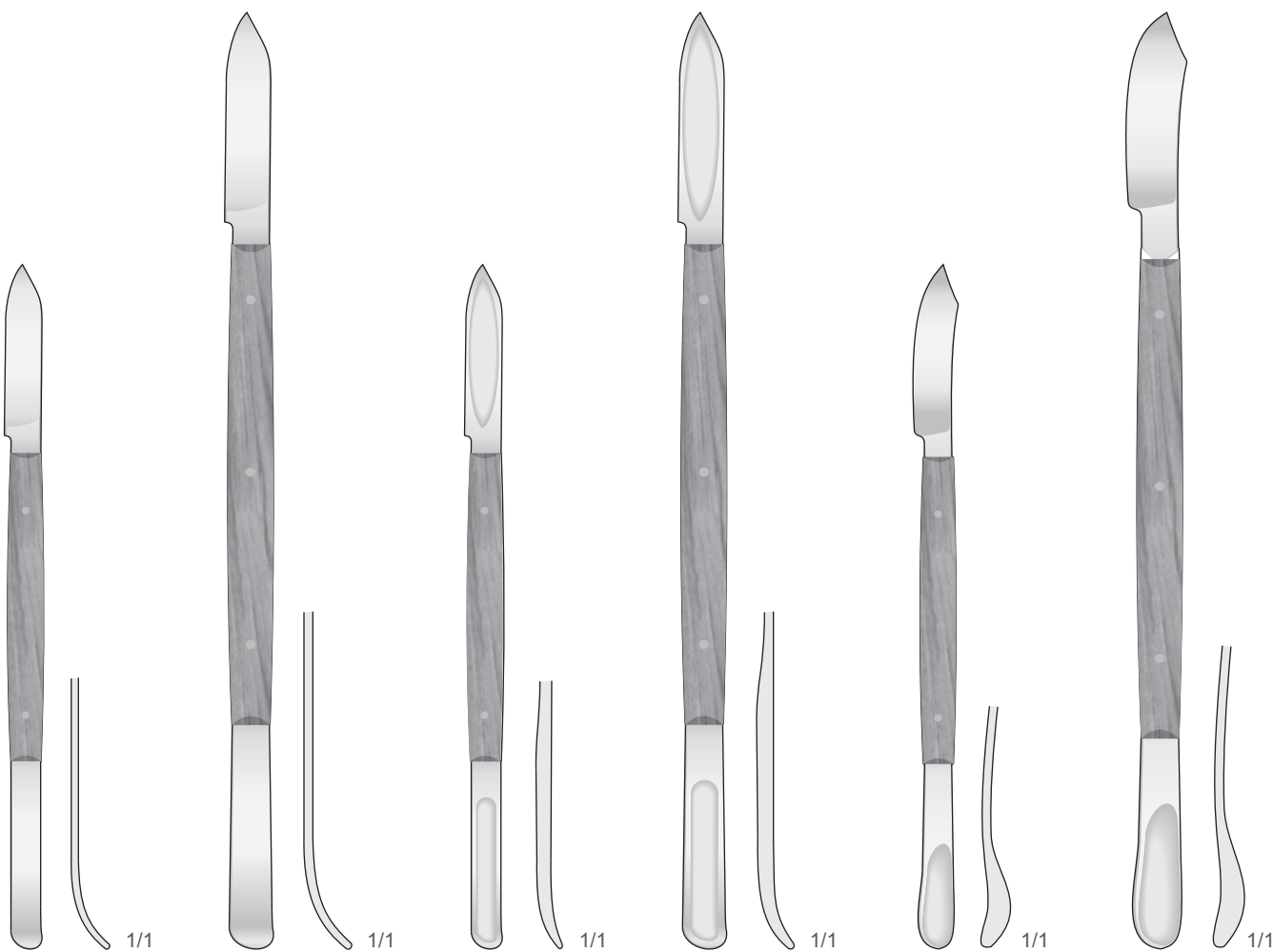

FAHNENSTOCK
CP

FAHNENSTOCK
CG

LESSMANN
CPL

LESSMANN
CGL

CPS

CGS



Spatel
Spatulas
Spatole
Espátulas
Spatules

Spatulas for plaster and alginate
Spatole per alginato e gesso



Flexible
Flexibel
Flexible
Flexible
Flessibile

Rigid
Fest
Rigide
Rigido
Rigido



**GRITMAN
CM**
175 mm

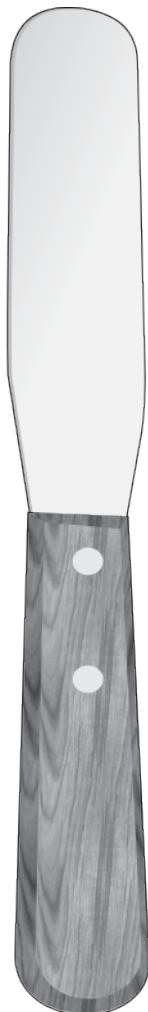

SA-1
200 mm



SA-2
200 mm



SA-3
200 mm

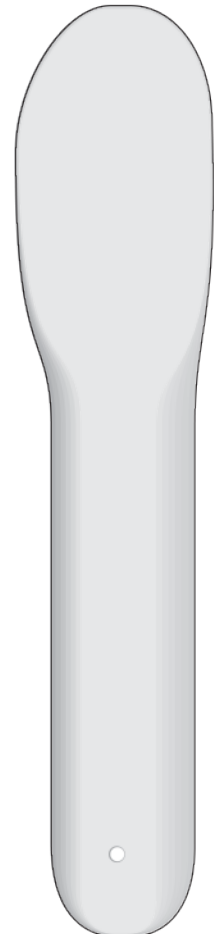

S18-8
185 mm



Instrumente für Laboratorium
Instruments for laboratory
Strumenti da laboratorio
Instrumentos para laboratorio
Instruments pour laboratoire

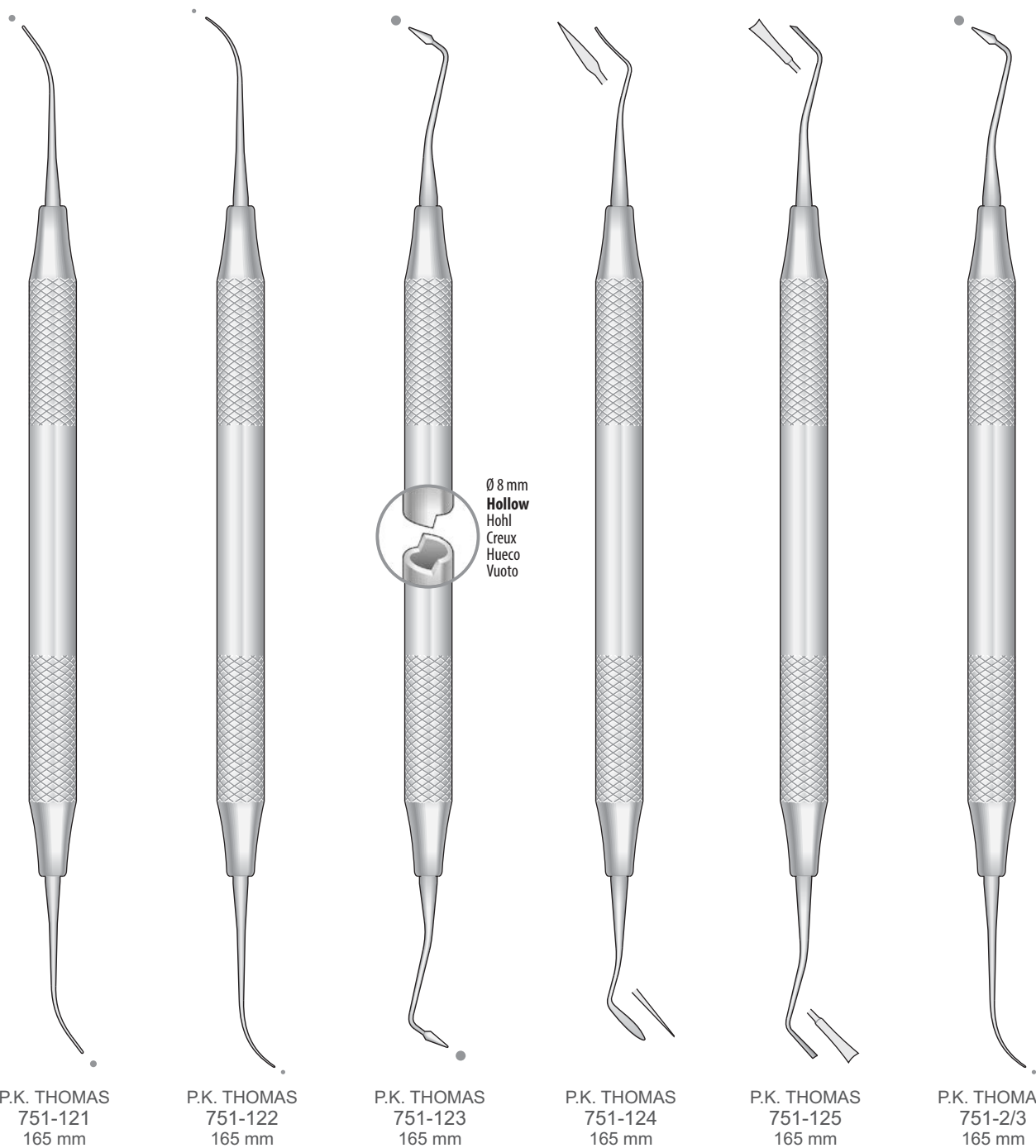

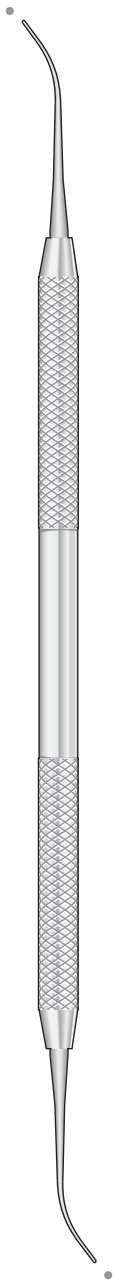

P.K. THOMAS
PT-1
165 mm

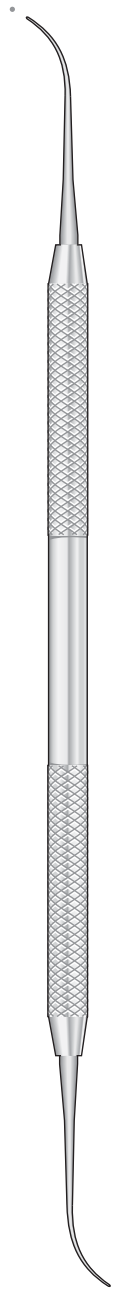

P.K. THOMAS
PT-2
165 mm

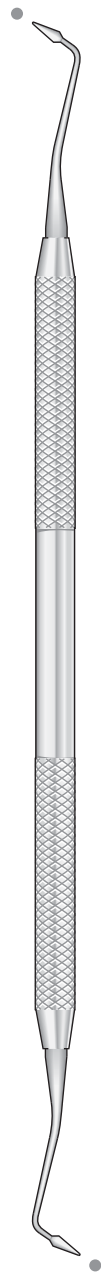

P.K. THOMAS
PT-3
165 mm

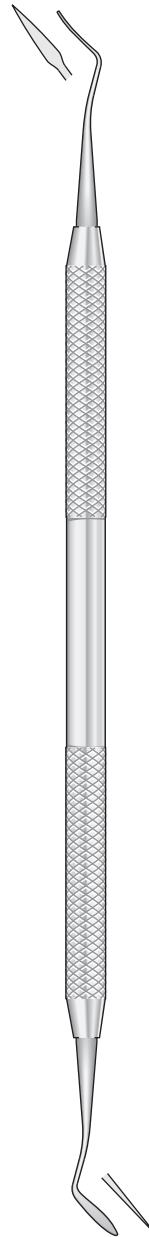

P.K. THOMAS
PT-4
165 mm

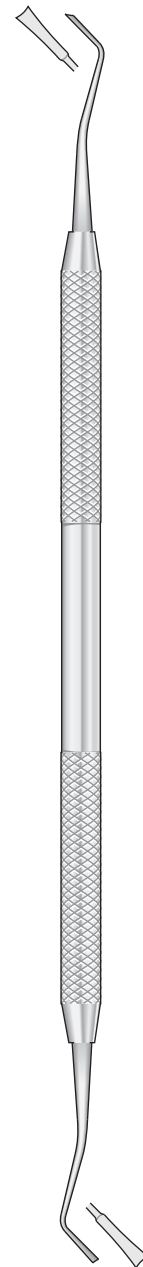

P.K. THOMAS
PT-5
165 mm



Instrumente für Laboratorium
Instruments for laboratory
Strumenti da laboratorio
Instrumentos para laboratorio
Instruments pour laboratoire

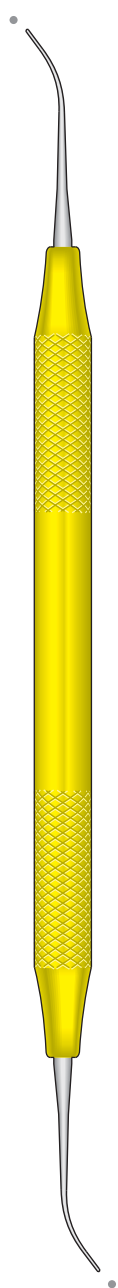

P.K. THOMAS
AL-PT1
165 mm

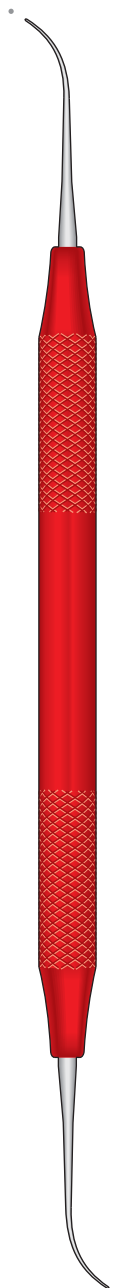

P.K. THOMAS
AL-PT2
165 mm

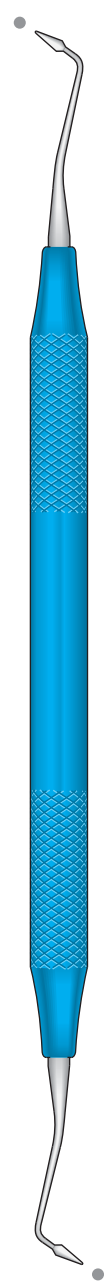

P.K. THOMAS
AL-PT3
165 mm

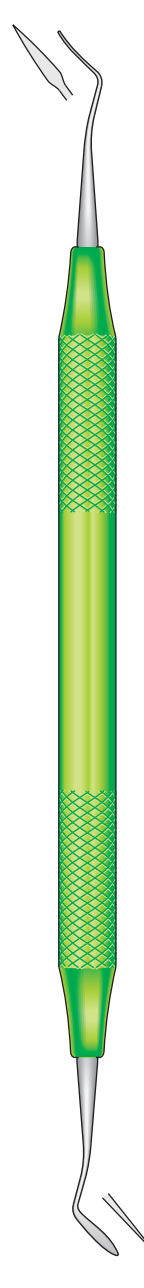

P.K. THOMAS
AL-PT4
165 mm

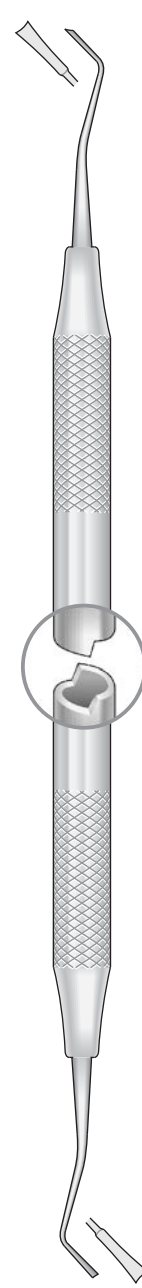

P.K. THOMAS
AL-PT5
165 mm

Ø 8 mm
Hollow
Hohl
Creux
Hueco
Vuoto

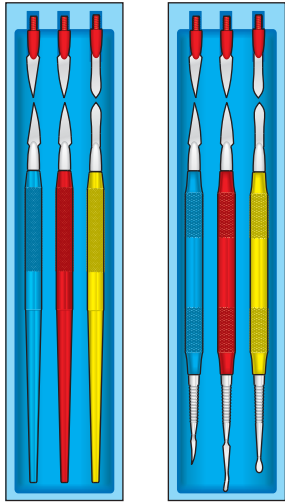

Biegsam - Flexible
Flessibili - Flexibles
Flexibles

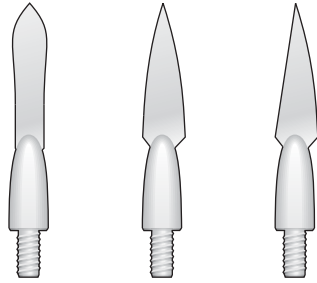

CL-1BCL-2BCL-3B

Superbiegsam - Superflexible
Superflessibili - Superflexibles
Superflexibles

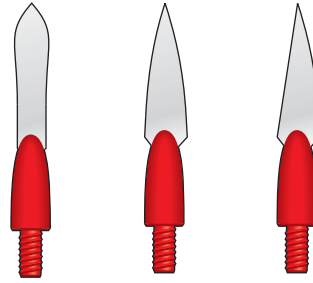

CL-1RCL-2RCL-3R



AL-SETC/1

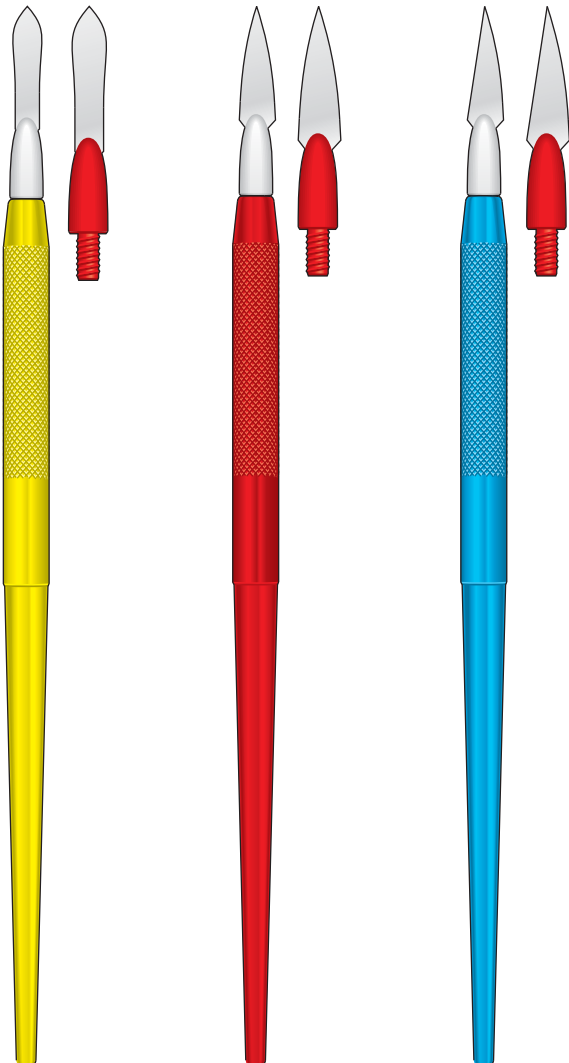

AL-SETC/2

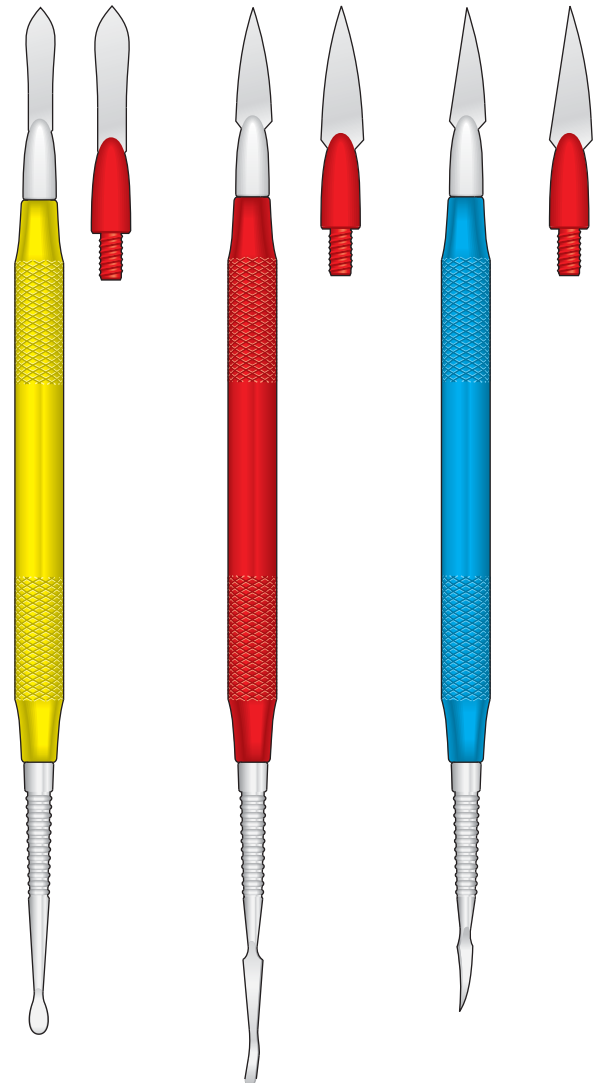



Instrumente für Laboratorium
Instruments for laboratory
Strumenti da laboratorio
Instrumentos para laboratorio
Instruments pour laboratoire

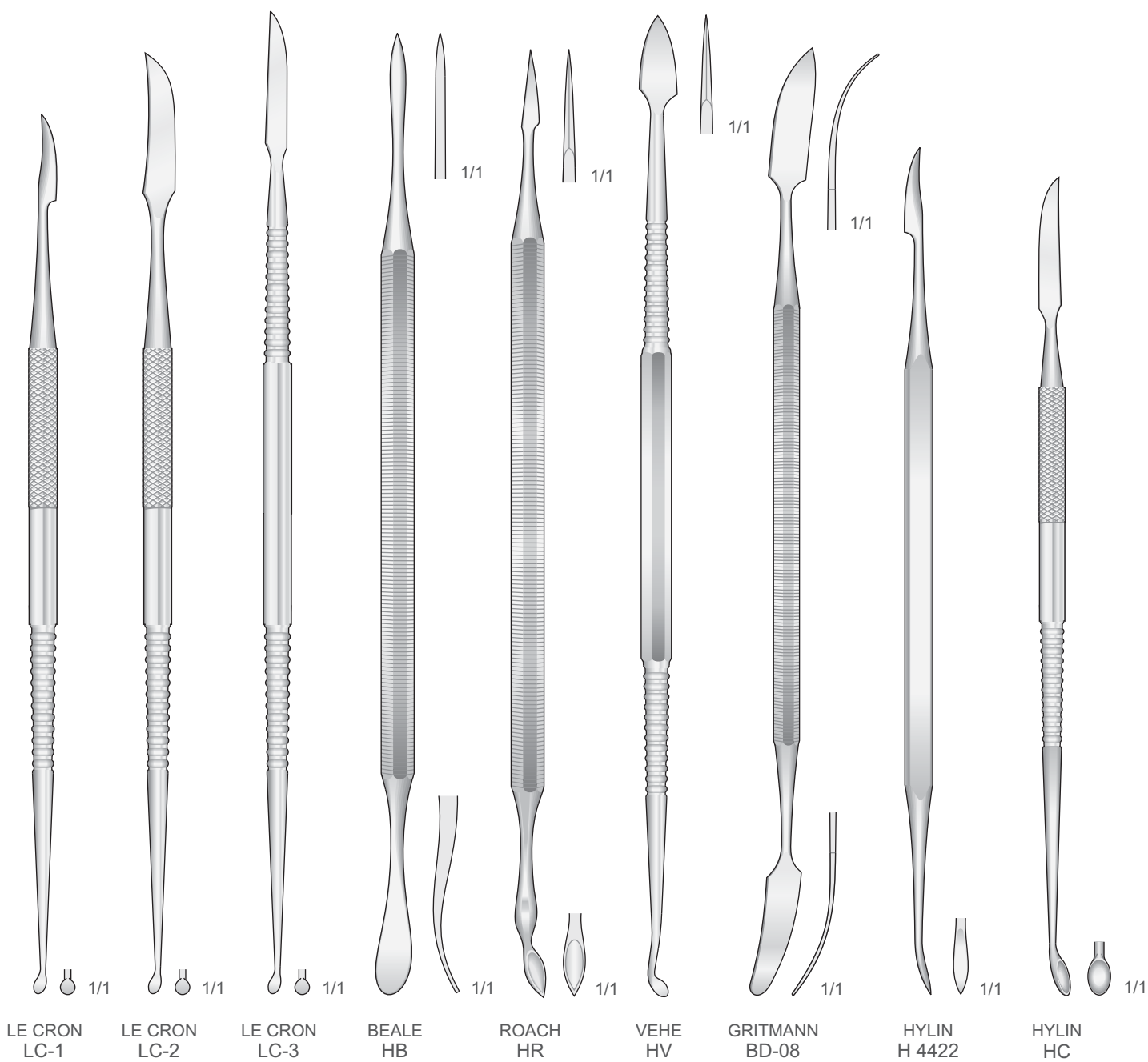

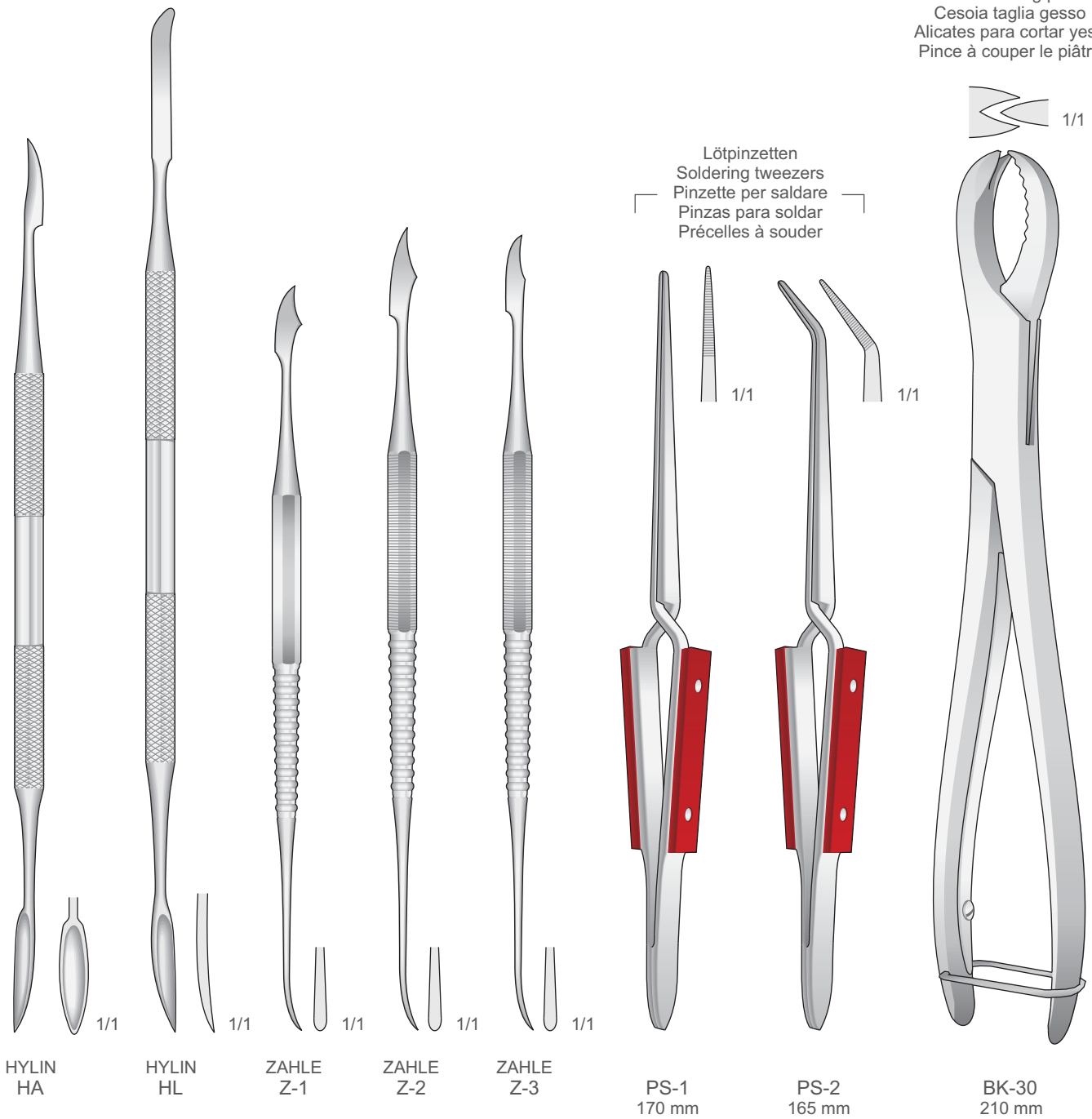

Gippschneidezange
Plaster cutting pliers
Cesoia taglia gesso
Alicates para cortar yeso
Pince à couper le plâtre

Lötpinzetten
Soldering tweezers
Pinzette per saldare
Pinzas para soldar
Précettes à souder

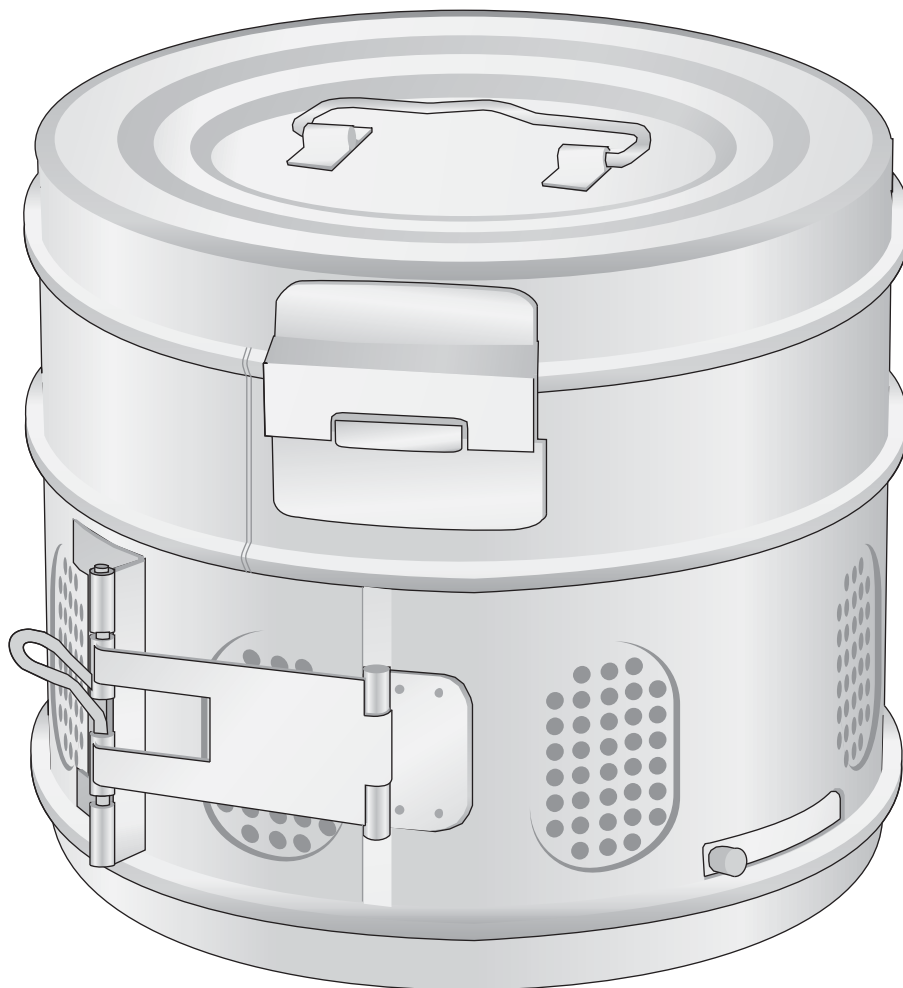

15 |

Instrument Maintenance

Instrumentenwartung
Entretien des instruments
Mantenimiento de instrumentos
Manutenzione degli strumenti

Sterilization

Sterilisierung
Stérilisation
Esterilización
Sterilizzazione



Gefäße aus Edelstahl
Stainless Steel Receptacles
Recipienti in acciaio inossidabile
Recipientes de acero inoxidable
Réipients en acier inoxydable

Nadeldose
Needle case
Scatola per aghi
Caja para agujas
Boîte à aiguilles



BS-1
Ø 78 mm h 15 mm

Nierenschalen
Kidney bowls
Bacinelle reniformi
Rifioneras
Bassins réniformes

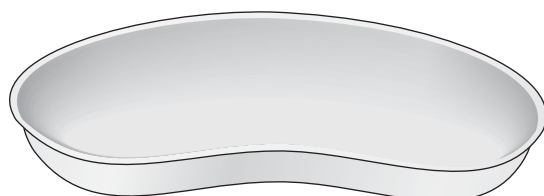

BR-20 200 mm
BR-25 250 mm
BR-28 280 mm

Verbandstofftrommeln
Dressing sterilizing drums
Cestelli cilindrici
Caja para esterilización
Boîte à stérilisation

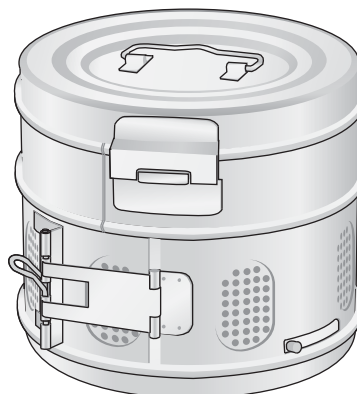

CS-12 125x125 mm
CS-15 150x150 mm
CS-19 190x145 mm

Runder Sterilbehälter mit Ausguss
Round sterile bowl
Capsule inox con fondo piano e becco
Cubetas de acero inoxidable
Cuvettes de acier inoxydable

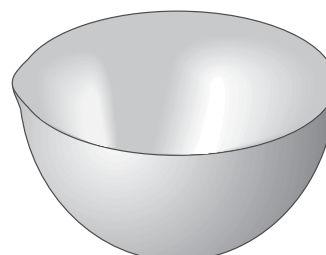

CS-01 Ø 40 mm 15 cc
CS-02 Ø 60 mm 75 cc
CS-03 Ø 80 mm 225 cc
CS-04 Ø 100 mm 325 cc
CS-05 Ø 120 mm 500 cc

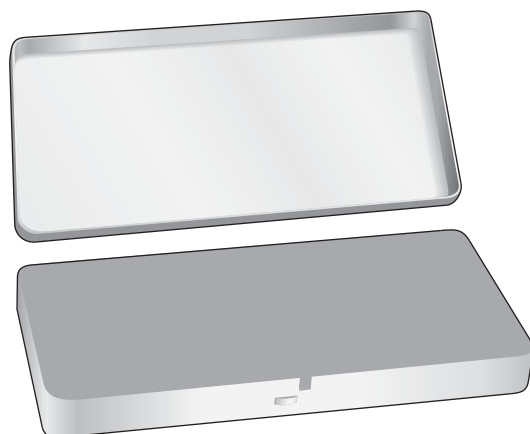

BS-32
180 x 85 x 20 mm

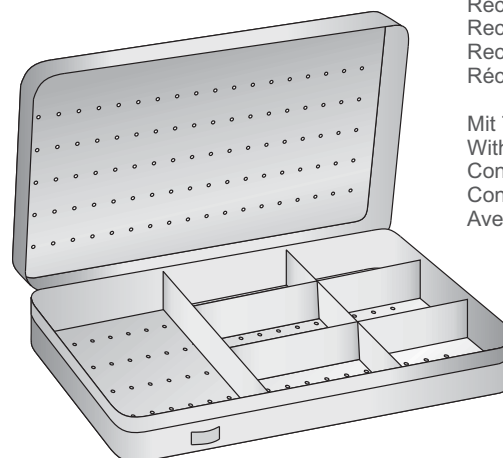

BS-27
150 x 90 x 20 mm

Gefäße
Receptacles
Recipiente
Recipientes
Réipients

Mit 7 box
With 7 box
Con 7 box
Con 7 box
Avec 7 box

Schalen
Trays
Vassoi
Bandejas
Bassins



VS-20 210 x 110 x 25 mm
VS-26 250 x 180 x 30 mm
VS-30 300 x 220 x 30 mm

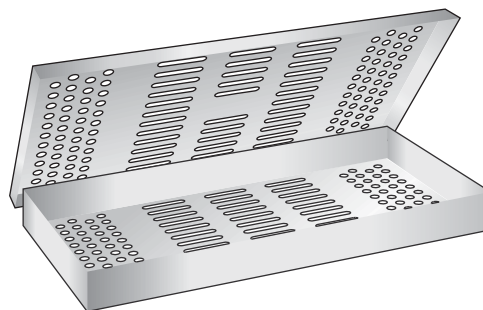

BS-41
275 x 130 x 25 mm

Mit Instrumentehalter und box
With Insert frames and box
Con griglia e scomparti
Con porta instrumentos y box
Avec Porte instruments et box

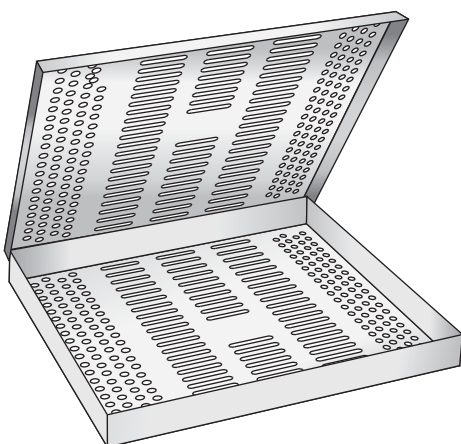

BS-43
285 x 190 x 25 mm

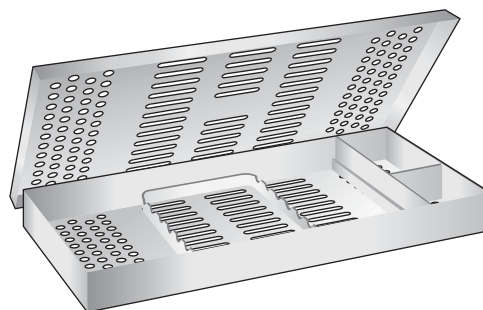

BS-40 275x130x25mm
BS-42 285x190x25mm



Steril Container
Sterilization Container
Contentori per sterilizzazione
Contenedores para esterilización
Conteneurs pour stérilisation

Rostfreier Stahl Sterilcontainer mit Silikoneinrichtung
Stainless Steel Sterilization Containers with silicone racks
Contentori per sterilizzazione in acciaio inossidabile con griglia in silicone
Contenedores para esterilización en acero inoxidable con soportes en silicona
Containers pour stérilisation en acier inoxydable avec des supports de silicone

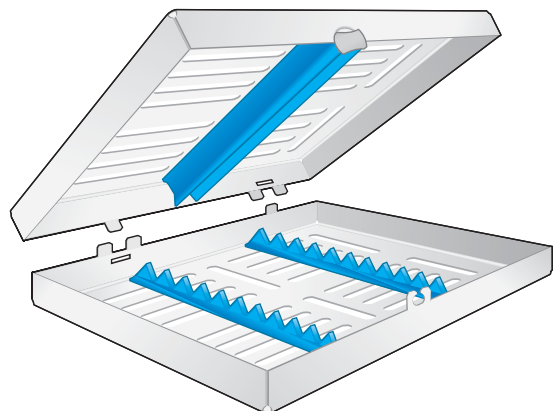

BS-60
185 x 135 x 35 mm
For 10 Instruments

BS-61
290 x 185 x 35 mm
For 20 Instruments

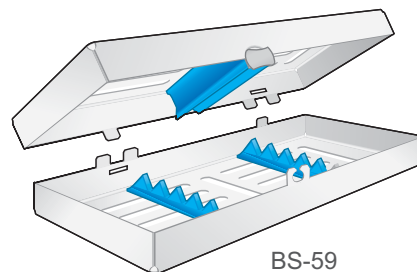

BS-59
185 x 75 x 35 mm
For 5 Instruments

CT-555
CT-560
CT-565



Sterilcontainer,
mit Deckel- und Bodenperforation,
passend in gängige Praxisautoklaven
Containers for sterilization,
with perforation in lid and bottom,
suitable for common practice autoclaves
Contentori dentali,
con coperchio e fondo perforato,
adatti a tutte le autoclavi comuni
Contenedores dentales,
con tapa y fondo perforados,
aptos para autoclaves habituales
Containers stérile,
avec perforation du couvercle et du fond,
convenant aux autoclaves courants

CT-651
CT-652
CT-653



Silikoneinrichtung für Tray
Silicone Racks for Tray
Griglia in Silicone per Tray
Equipo de silicona para Tray
Aménagement en silicone pour Tary

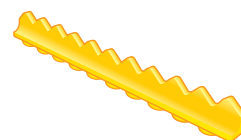

TRANSLUCENT YELLOW
SIL-01
130 mm

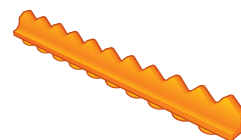

ORANGE
SIL-02
130 mm

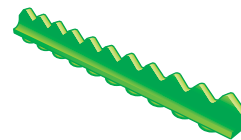

TRANSLUCENT GREEN
SIL-03
130 mm

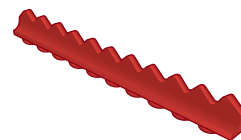

RUST RED
SIL-04
130 mm

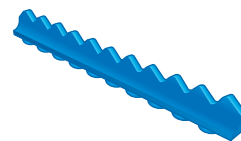

BLUE
SIL-05
130 mm



Alu
Aluminium
Alluminio
Aluminio
Aluminium

CT-555
300 x 140 x 40 mm
CT-651
310 x 190 x 40 mm

CT-560
300 x 140 x 70 mm
CT-652
310 x 190 x 65 mm

CT-565
300 x 140 x 100 mm
CT-653
310 x 190 x 130 mm

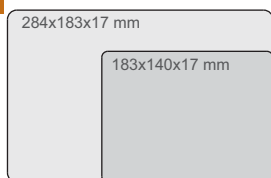

Farbcodiert-Tray-Unterteile für 17 instrumente
Color-Coded bases for 17 instruments
Vassoio colorati per 17 strumenti
Bandejas en colores para 17 instrumentos
Plateaux colorés pour 17 instruments

Für 17 instrumente
For 17 instruments
Per 17 strumenti
Para 17 instrumentos
Pour 17 instruments

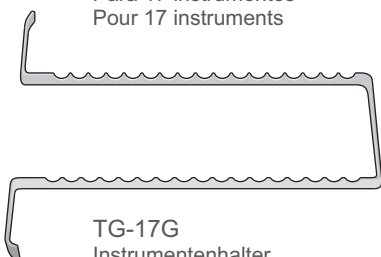

TG-17G
Instrumentenhalter
Insert frames
Griglia Portastrumenti
Porta instrumentos
Porte instruments



TG-17A
284x183x17 mm
Unterteile allein
Only base
Vassoio solo
Bandeja suelta
Plateau seul

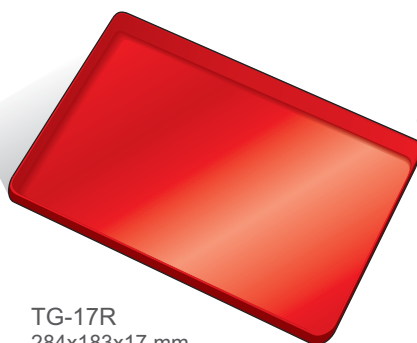

TG-17R
284x183x17 mm
Unterteile allein
Only base
Vassoio solo
Bandeja suelta
Plateau seul

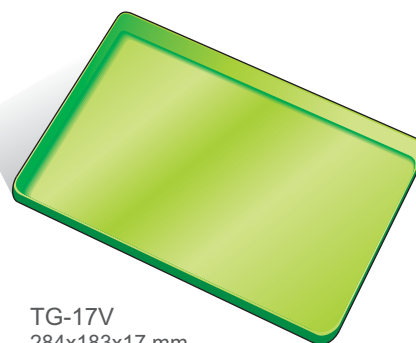

TG-17V
284x183x17 mm
Unterteile allein
Only base
Vassoio solo
Bandeja suelta
Plateau seul

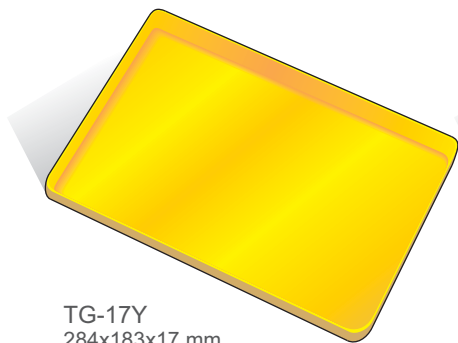

TG-17Y
284x183x17 mm
Unterteile allein
Only base
Vassoio solo
Bandeja suelta
Plateau seul

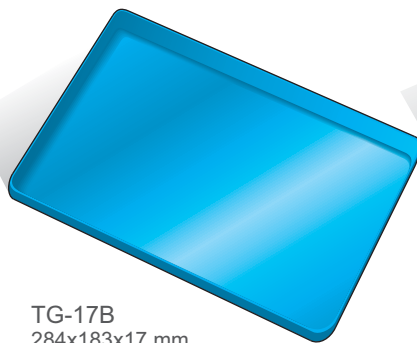

TG-17B
284x183x17 mm
Unterteile allein
Only base
Vassoio solo
Bandeja suelta
Plateau seul



TG-17C
288x187x29 mm
Tray-Deckel, grau
Lid - Grey only
Coperchio - Solo argento
Tapa en color gris
Couvercle - seulement en gris



Aluminium MIDI Tray
Aluminium MIDI Trays
Tray in alluminio, misura MIDI
Bandejas de aluminio, tamaño MIDI
Boîtes en aluminium, format MIDI

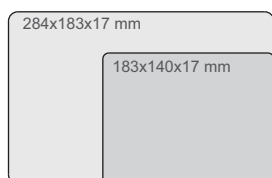

Farbcodiert-Tray-Unterteile für 8 instrumente
Color-Coded bases for 8 instruments
Vassoi colorati per 8 strumenti
Bandejas en colores para 8 instrumentos
Plateaux colorés pour 8 instruments

Für 8 instrumente
For 8 instruments
Per 8 strumenti
Para 8 instrumentos
Pour 8 instruments

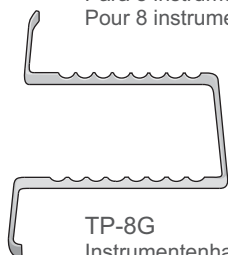

TP-8G
Instrumentenhalter
Insert frames
Griglia Portastrumenti
Porta instrumentos
Porte instruments



TP-8A
183x140x17 mm
Unterteile allein
Only base
Vassoio solo
Bandeja suelta
Plateau seul



TP-8R
183x140x17 mm
Unterteile allein
Only base
Vassoio solo
Bandeja suelta
Plateau seul

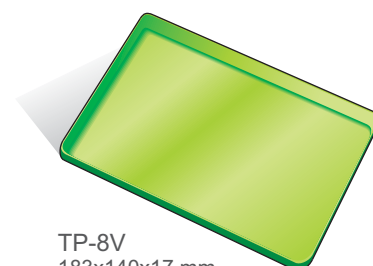

TP-8V
183x140x17 mm
Unterteile allein
Only base
Vassoio solo
Bandeja suelta
Plateau seul

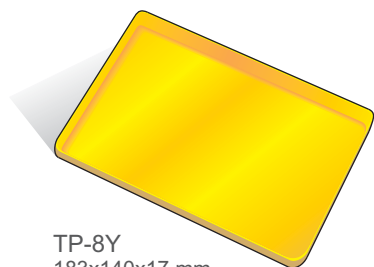

TP-8Y
183x140x17 mm
Unterteile allein
Only base
Vassoio solo
Bandeja suelta
Plateau seul



TP-8B
183x140x17 mm
Unterteile allein
Only base
Vassoio solo
Bandeja suelta
Plateau seul



TP-8C
187x145x25 mm
Tray-Deckel, grau
Lid - Grey only
Coperchio - Solo argento
Tapa en color gris
Couvercle - seulement en gris

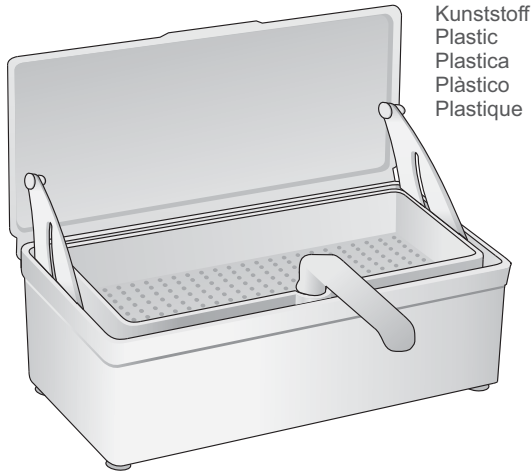

Kunststoff
Plastic
Plastica
Plástico
Plastique

BS-100
255 x 105 x 85 mm

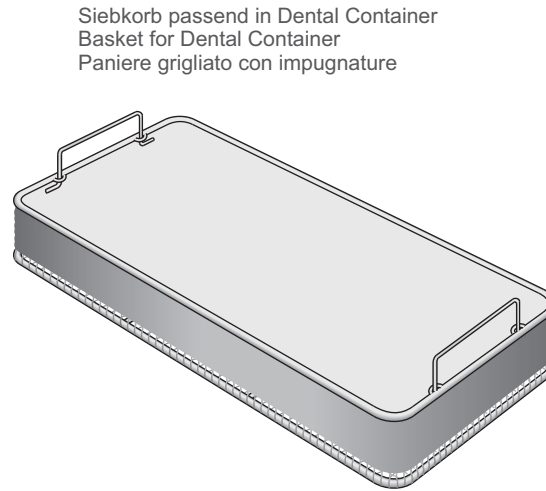

Siebkorb passend in Dental Container
Basket for Dental Container
Paniere grigliato con impugnature

CT-650
265 x 120 x 45 mm

Rostfrei - Stainless steel - Inox - Inoxidable - Inoxydable
Norm-tray complet mit tray-unterteile, deckel und instrumentenhalter für 23 instrumente
Instrument tray complete with base, lid and insert frame for 23 instruments
Portastrumenti completo di vassoio, coperchio e griglia per 23 strumenti
Bandeja completa de tapa y porta instrumentos para 23 instrumentos
Boite complete avec plateau et couvercle pour 23 instrumentes

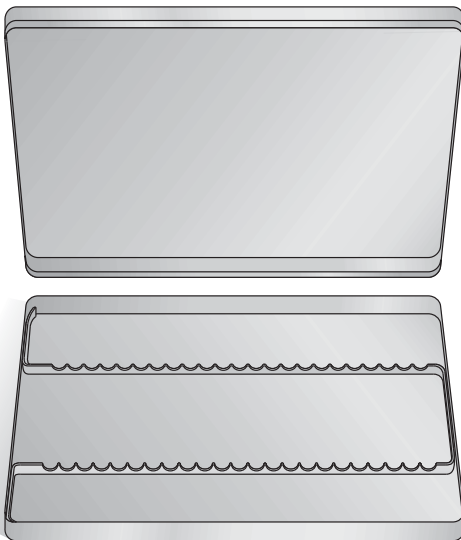

TRAY INOX
T-I
284 x 183 x 17 mm

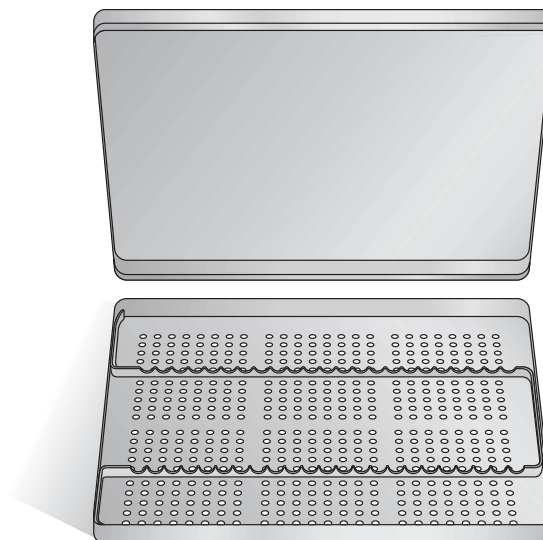

TRAY INOX
T-IF
284 x 183 x 17 mm



Steril Container
Sterilization Container
Contentori per sterilizzazione
Contenedores para esterilización
Conteneurs pour stérilisation

		Stainless Steel - Aluminium Rostfrei - Aluminium Acier inoxydable - Aluminium Acero inoxidable - Aluminium Acciaio inossidabile - Alluminio
--	--	----------------------------------------------------------------------------------------------------------------------------------------------------------------

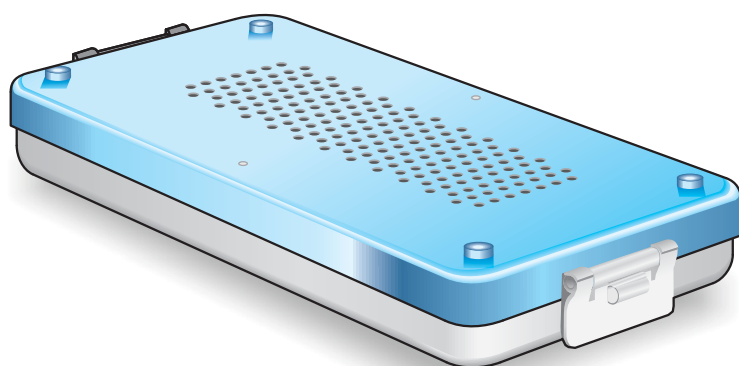

Small
outside: 300 x 140 x 40 mm
inside: 280 x 130 x 27 mm

- CT-555N
- CT-556N
- CT-557N
- CT-558N
- CT-559N

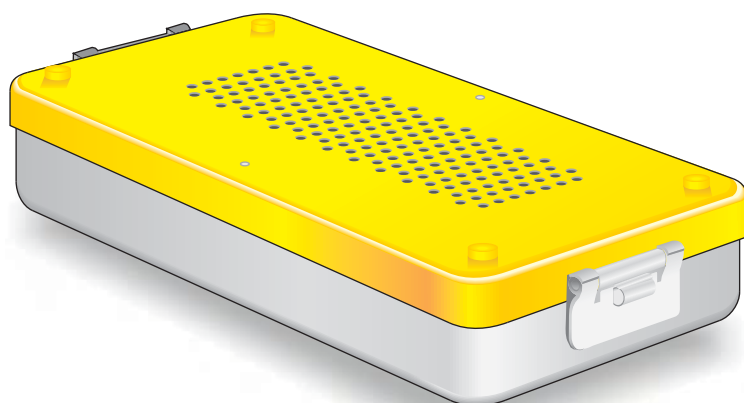

Medium
outside: 300 x 140 x 70 mm
inside: 280 x 130 x 55 mm

- CT-560N
- CT-561N
- CT-562N
- CT-563N
- CT-564N



Large
outside: 300 x 140 x 100 mm
inside: 280 x 130 x 84 mm

- CT-565N
- CT-566N
- CT-567N
- CT-568N
- CT-569N



GS-02
145 mm

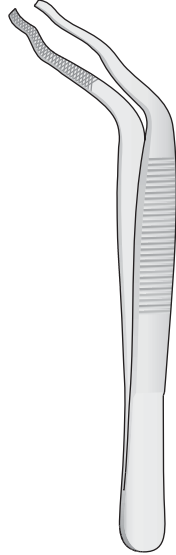

DAVIS
GS-03
160 mm



DAVIS
GS-04
200 mm

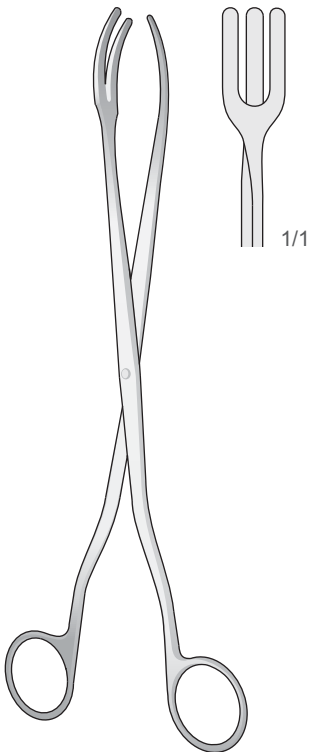

GS-10
200 mm

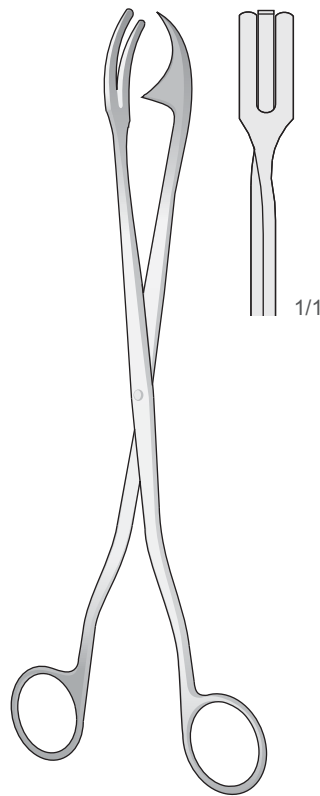

ROGGE
GS-06
230 mm

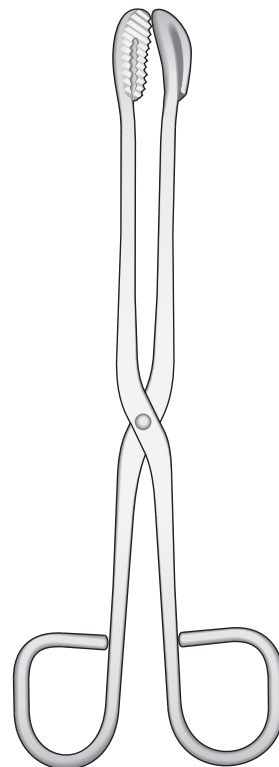

GS-13
200 mm



Vorbereitung - Nagel scheren
Preparation - Nail scissors
Preparazione - Forbici per unghie
Preparación - Tijeras para uñas
Préparation - Ciseaux à ongles

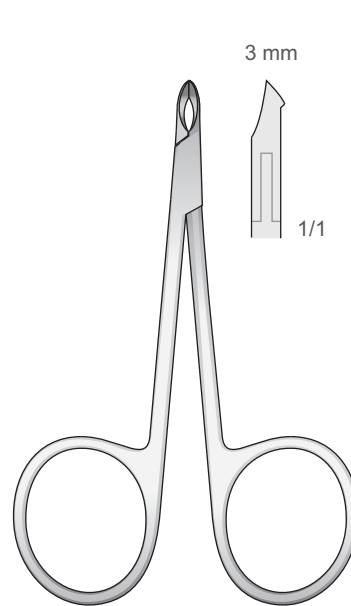

GS-40
85 mm

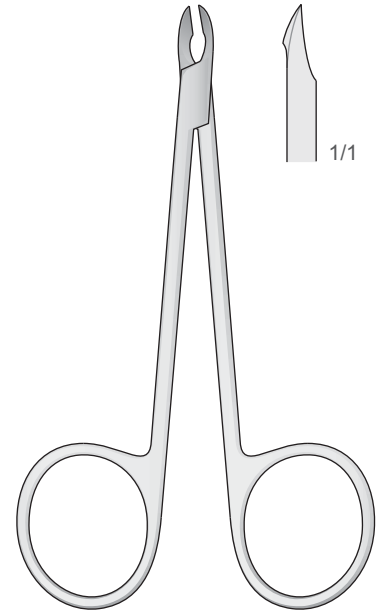

GS-52
100 mm

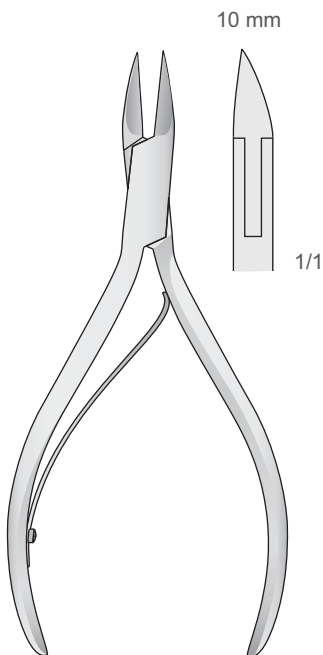

GS-42
100 mm

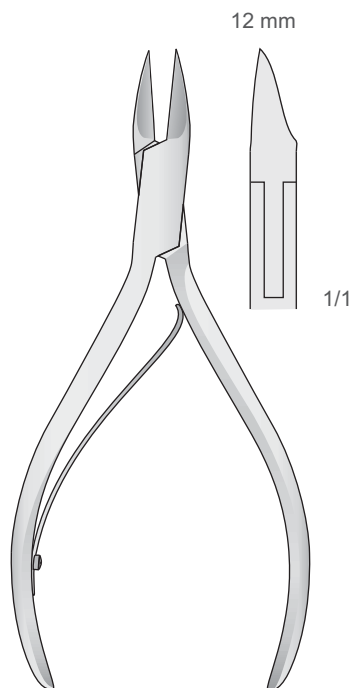

GS-44
110 mm

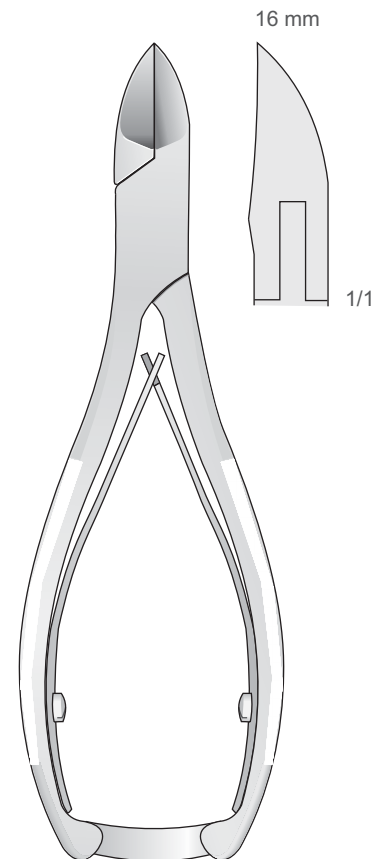

GS-48
140 mm

A-Z



A-Z |

Alphabetical Index
Alphabetischen Index
Index alphabétique
Índice alfabético
Índice alfabético |



A

ADERER, Wire bending Pliers	324
ADSON, Suction tubes	319
- Delicate forceps	114
- Tissue forceps	122, 131, 132, 133, 136
- Titanium Tissue Forceps	118
ADSON-BROWN, Delicate forceps	114
- Tissue forceps	131
AINSWORTH, Rubber-Dam instrumente	308
ALLIS, Tissue Grasping forceps	174
ANDREWS-PYNCHON, Suction tubes	315
APEXO, Root elevators	50
ARKANSAS, Sharpening Stones	356
ARRUGA, Needle Holders	158
AUSTIN, Retractors	184

B

BABY-ALLIS, Tissue Grasping forceps	174
BABY-CRILE, Hemostatic Forceps	173
BABY-CRILEWOOD, Needle Holders	156
BABY-METZENBAUM, Scissors	98
BABY-MIXTER, Hemostatic Forceps	171
BABY-YANKAUER, Suction tubes	315
BACKHAUS, Towl Clamps	165
BALL, Filling Instruments	292
BARRAQUER, Tissue forceps	130
- Needle Holders	142
BARRY, Root elevators	65
BARTH, Curettes	235
BEALE, Instruments for laboratory	345
BEASLEY-BABCOCK, Tissue forceps	133
BEEBE, Scissors	326
- Wire and Plate cutting Scissors	109
BEIN, Root elevators	43
BENNETT, Raspatories	226
BERNARD, Root elevators	61
BEYER, Bone rongeurs	244
BISHOP, Cheek Retractor	191
BISHOP-HARMON, Delicate forceps	114
BLACK, Cavity preparation Instruments	283, 298
BLUMENTHAL, Bone rongeurs	242
BÖHLER, Bone rongeurs	245
BÖHM, Pliers for telescope crowns	335
BOLEY, Measuring Instruments	330
BOWLED-HENRY, Retractors	184
BOYNTON, Needle Holders	158
BOYS-ALLIS, Tissue Grasping Forceps	174
BREWER, Clamps forceps	309
BROWN, Delicate forceps	114
- Tissue forceps	131
BRUENINGS, Tongue depressors	195
BRUNS, Curettes	236
BUCHWALD, Tongue depressors	195
BUCK, Gingivectomy knives	301
- Bone files	239

C

CARVER, Amalgam carvers	297
CASTROVIEJO, Delicate forceps	114
- Needle Holders	141, 143, 144, 145, 146
- Measuring Instruments	218
CAWOOD-MINNESOTA, Cheek Retractors	191
CHADWICK, Scissors	97
CHOEN, Tissue Nippers	240
CHOMPRET, Syndesmotomes	70
CITELLI, Bone cutting forceps	246
CLEVELAND, Bone rongeurs	245
COHEN, Extracting forceps	31
COLLEGE, Titanium tissue forceps	118
- Cotton and Dressing pliers	120, 121
COLLIN, Tongue holding forceps	195
COLUMBIA, Curettes	262, 266
- Retractors	191
CONVERSE, Needle Holders	153
CORN, Forceps	138
COTTLE, Scissors	86
- Surgical Mallets	203
- Chisels	202

COTTLE-KNAPP, Scissors	86
COUPLAND, Suction tubes	317
- Root elevators	54
CRANE-CAPLAN, Curettes	306
- Tissue forceps	123
CRANE-KAPLAN, Gingivectomy knives	301
CRANEPICK, Root levators	58
CRILE, Hemostatic Forceps	172
- Needle Holders	159
CRILE-MURRAY, Needle Holders	149
CRILE-WOOD, Needle Holders	149, 155, 156
CRYER, Root levators	53
- Extracting Forceps	24, 28, 33, 34
CUSHING, Retractors	180

D

DANDY-MOSQUITO, Hemostatic forceps	168
DAVIS, Forceps for sterile instruments	358
DE BAKEY, Tissue forceps	122, 137
- Titanium Tissue forceps	118
- Needle holders	154
DE MARCO, Curettes	303
DEAN, Scissors	94
DERF, Needle Holders	149, 153
DESMARRES, Retractors	179
- Tissue Forceps	130
DIETRICH, Needle Holders	148
DINGMANN, Mouth gags	193
- Bone Holding Forceps	220
DOCKHORN, Retractors	180

E

ELLIS, Knives	79
EPKER, Osteotomes	202

F

FAHNENSTOCK, Wax knives	339
FAHRENKRUG, Root elevators	59
FARABEUF, Retractors	190
FAURE, Towel Clamps	165
FEDI, Periodontal chisels	285
FELSCH, Extracting forceps	16
FELT, Composite Instruments	271, 273
FOITZIK, Bone Syringes	216
FOSTER-GILLIES, Needle Holders	157
FRAZIER, Suction tubes	318, 319
FREER, Osteotomes	199
- Periosteals	204
FREER-YASARGIL, Periosteals	204
FRENZEL, Tongue depressors	195
FRIEDMANN, Bone rongeurs	242, 244
FURRER, Copper ring removing Pliers	335

G

GARDNER, Bone rongeurs	245
GERALD, Tissue forceps	129, 136
- Titanium Tissue Forceps	118
GERALD-BROWN, Tissue Forceps	129
GIESSEN, Periosteals	204
GILLIES, Retractors	177
- Tissue Forceps	123
GOLDMAN-FOX, Gingivectomy knives	301
- Curettes	304
- Elevators	229
- Scissors	91, 94, 105, 106
- Periodontal Probes	253
GOLDMAN-FOX-WILLIAMS, Periodontal Probes	289
GOLDSTEIN, Composite Instruments	271, 273
GRACEY, Curettes	261, 263, 264, 302, 303
GRAEFE, Knives	79
- Tissue Forceps	123, 133
GREENBERG-PAR, Scissors	101
GREENE, Retractors	194
GREGORY, Scissors	106
GRITMAN, Spatulas	340
- Instruments for Laboratory	345
GROSS, Dressing Forceps	167



H

HAJEK , Surgical Mallets	203
HALSEY , Needle Holders	149, 153
HALSTED , Hemostatic Forceps	170, 173
HALSTED-MOSQUITO , Hemostatic Forceps	170
- Ligating Instruments	329
HARRIS , Extracting Forceps	27, 30
HARTMANN , Retractors	186
HARTMANN-BABY-MOSQUITO , Hemostatic Forceps	168
HEGAR , Needle Holders	155, 159
HEIDBRINK , Root elevators	47
HEIDEMANN , Spatulas	291
HEISTER , Mouth Gags	188
HEMINGWAY , Curettes	232, 233
HENAHAN , Raspatories	225
HIRSCHFELD , Periodontal Files	267
HOLLENBACK , Filling Instruments	294, 297
HOPKINS , Raspatories	228
HOWARD , Bone Files	238
HULL , Extracting Forceps	28
HYLIN , Root elevators	56
- Instruments for laboratory	345, 346

I

ILIC , Tissue Nippers	240
INDIA , Sharpening Stones	356
IRIS , Scissors	86, 88, 101, 103, 104
IVORY , Rubber-Dam Instruments	308, 310, 311, 312
IWANSON , Measuring Instruments	330

J

JACOBSON , Curettes	235
- Needle Holders	145
JACOBSON-MICRO , Hemostatic Forceps	168
JAMESON , Scissors	87
JAMESON-WERBER , Scissors	87
JANSEN , Curettes	235
JAQUETTE , Curettes	265, 305
JONES , Towl Clamps	165
JOSEPH , Retractors	177
- Scissors	89, 106
JUDD-ALLIS , Tissue Grasping Forceps	174

K

KELLY , Scissors	92, 102, 103
- Hemostatic Forceps	172
KERLING , Copper ring removing Pliers	335
KERPEL , Curettes	234
KERRISON , Bone rongeurs	246
KEYES , Tissue Punches	213
KILIAN , Raspatories	227
KILNER , Scissors	87, 91, 93, 101
KIRKLAND , Gingivectomy knives	287, 301
KIRSCH , Retractors	182
KLEINER-KUTZ , Bone rongeurs	244
KOCHER , Retractors	179, 180
- Hemostatic Forceps	171, 172
KOCHER-LANGENBECK , Retractors	184
KÖNIG , Raspatories	224
KOPP , Root elevators	57
KRALLENHEBER , Root elevators	53
KRAMER , Curettes	264
KRAMER-NEVINS , Curettes	264
- Gouges	200
KROENIG , Tongue Holding Forceps	195

L

LA FORCE , Knives	79
LA GRANGE , Scissors	94, 105
LADMORE , Filling Instruments	295
LAHEY , Retractors	180
LANGE , Scalers	268
LANGENBECK , Retractors	184
LANGER , Curettes	266
LE CLUSE , Root elevators	65
LE CRON , Instruments for Laboratory	345

LEMPERT , Bone rongeurs	243
LERICHE , Hemostatic Forceps	173
LESSMANN , Wax knives	339
LEXER , Scissors	95
LEXER-BABY (KNAPP) , Scissors	101
LICHTENBERG , Needle Holders	158
LINDO-LEVIEN , Root elevators	57
LISTER , Sinus Forceps	167
LITTAUER , Scissors	108
LOCKING , Cotton and Dressind Pliers	121
LOCKLIN , Scissors	90, 92
LORNA , Towl Clamps	166
LUCAE , Surgical Mallets	203
LUCAS , Curettes	232
LUER , Bone rongeurs	243
LUKS , Endodontic Instruments	254
LUNIATSCHEK , Cotton Applicators	256
- Membrane Placement Instruments	214

M

MARKLEY PLUGGERS , Filling Instruments	294
MARTINI , Curettes	235
MATHIEU , Needle Holders	158, 160, 161
MATY , Mouth Gags	189
MAYO , Scissors	96, 104
MAYO-HEGAR , Needle Holders	154, 159
MAYO-LEXER , Scissors	95
MAYO-STILLE , Scissors	95
McCALL , Curettes	266, 305
McINDOE , Tissue Forceps	123
McKESSON , Suction Tubes	316
MEAD , Surgical Mallets	203
- Raspatories	228
- Extracting Forceps	35
- Bone rongeurs	242
MENEGHINI , Raspatories	227
MERIAM , Cotton and Dressing Pliers	120, 121
MERRIT , Periodontal Probes	253
MERSHON , Band Pusher	328
METZENBAUM , Scissors	89, 97, 98, 99, 103, 104
METZENBAUM-FINO , Scissors	98, 99, 100
MICRO-ADSON , Tissue Forceps	133
MICRO-HALSTED , Hemostatic Forceps	169
MICRO-RYDER , Needle Holders	148
MICRO-VASCULAR , Needle Holders	154
MIDDELDORPF , Retractors	182
MILLER , Bone Files	238
- Forceps	138
- Ligating Instruments	329
MILLER-APEXO , Root elevators	55
MILLER-COLBURN , Raspatories	231
MINI-FRIEDMANN , Bone rongeurs	241, 242
MINI-GILLIES , Needle Holders	150, 157
MINI-LAMBOTTE , Osteotomes	199
MINI-LANGENBECK , Retractors	177
MINI-LEXER , Osteotomes	202
MINI-OLSEN-HEGAR , Needle Holders	150
MINNESOTA , Retractors	191
MISCH , Retractors	192
MITCHEL , Scalers	268
MOLT , Mouth Gags	188
- Curettes	237
- Raspatories	225, 226, 229, 231
MOLT-DOYEN-COLLIN , Mouth Gags	188
MOLT-DOYEN-JANSEN , Mouth Gags	188

N

NABERS , Periodontal Probes	290
NEUMANN , Scissors	94
NEVIUS , Extracting Forceps	25
NOYES , Micro Scissors	83
NYSTRÖM , Matrix Retainers	312

O

OBWEGESER , Retractors	183, 186, 187, 192
- Raspatories	223
OBWEGESER-FREER , Periosteal	204
OCHSENBEIN , Periodontal Chisels	285, 286



OLSEN-HEGAR, Needle Holders 150, 157
 ORBAN, Gingivectomy Knives 287, 301
 ORINGER, Mouth Gags 189

P

P.K.THOMAS, Instruments for Laboratory 341, 342, 343
 PALMER, Rubber Dam Clamp Forceps 309
 PAQUETTE, Palatal Gingival razor blade 78
 PARMLY, Extracting Forceps 26
 PARTSCH, Osteotomes 201
 - Chisel 201
 PEAN, Hemostatic Forceps 171
 PEAN-MURPHY, Dressing Forceps 167
 - Ligating Instruments 329
 PECK-JOSEPH, Scissors 106
 PEET, Nerve Instruments 39
 - Hemostatic Forceps 169
 PELTON-CRANE, Suction Tubes 318
 PERRY, Tissue Forceps 124
 PHYSICK, Extracting Forceps 31
 POTT, Root elevators 60
 POTTS-SMITH, Tissue Forceps 135
 PRICHARD, Raspatories 226

Q

QUINBY, Scissors 97

R

RAGNELL, Retractors 180
 RAGNELL-DAVIS, Retractors 180
 REYNOLDS, Scissors 93
 ROACH, Instruments for Laboratory 345
 ROGER, Raspatories 227
 ROGGE, Forceps for sterile instruments 358
 ROSER-KÖNIG, Mouth Gags 188
 ROSIN, Root elevators 48
 ROUTURIER, Extracting Forceps 11
 ROUX, Retractors 190
 ROUX-MAGNUS, Retractors 190
 RULE, Curettes 307
 RUSKIN, Bone rongeurs 244
 RUSSIAN, Forceps 138
 RYDER, Needle Holders 151

S

SANDERS, Gingivectomy Knives 301
 SAROT, Needle Holders 155
 SAUTTER, Periosteal 204
 SCHAEDEL, Towl Clamps 165
 SCHEDE, Curettes 236
 SCHLUGER, Bone Files 239
 SEAN-MILLER, Retractors 179
 SELDIN, Root elevators 58, 59
 - Raspatories 224
 SEMKEN, Tissue Forceps 127, 137
 SENN-GREEN, Retractors 180
 SHURE, Separating Pliers 327
 SMAHA, Needle Holders 161
 SMITH, Scissors 107
 - Wire cutting Pliers 325
 SPENCER, Scissors 108
 STELLBRINK, Bone rongeurs 241
 STERNBERG, Retractors 191
 STEVENS, Scissors 85, 93, 97
 - Needle Holders 148
 STIEGLITZ, Extracting Forceps 39
 STILLE, Tissue Forceps 126
 STITCH, Scissors 85
 STOKE, Rubber Dam Clamp forceps 309
 SUGARMAN, Bone Files 239
 SWEDISH, Needle Holders 152

T

TAYLOR, Curettes 265, 306
 TG CHISELS, Periodontal Chisels 286
 TOBOLD, Retractors 186

TOFFLEMIRE, Matrix Retainers 312
 TOMES, Extracting Forceps 28
 TÖNNIS, Needle Holders 159
 TÖNNIS-ADSON, Scissors 98
 TOWNER, Gingivectomy Knives 301
 - Curettes 165
 TOWNER-JAQUETTE, Curettes 307

U

UFFENORDE, Curettes 234
 UNIVERSAL, Crown Removers 338
 - Cotton Applicators 256
 UNIVERSITY OF MICHIGAN, Periodontal Probes 253, 290

V

VEHE, Instruments for Laboratory 345
 VOLKMANN, Curettes 235, 236

W

WAHL, Bone Files 239
 WALTON, Scissors 85
 WANGENSTEEN, Tissue Forceps 136
 WARD, Filling Instruments 278
 WARWICK-JAMES, Root elevators 48
 WASSMUND, Retractors 194
 WEBSTER, Needle Holders 153
 WEDELSTAEDT, Cavity preparation Instruments 298
 WEINGART, Wire bending Pliers 324
 WEITLANER, Retractors 220
 WERTHEIMER, Suction Tubes 319
 WESTCOTT, Micro Scissors 83
 - Filling Instruments 280, 295
 WHITE, Filling Instruments 281
 WHITEHEAD-JENNINGS, Mouth Gags 193
 WIEDER, Retractors 186
 WILAND, Amalgam Carvers 297
 WILLIAMS, Periodontal Probes 253
 WILLIGER, Curettes 234, 235
 - Raspatories 223
 WINTER, Root elevators 63, 64
 WITZEL, Extracting Forceps 38
 WOODSON, Filling Instruments 295

Y

YANKAUER, Suction Tubes 315
 YOUNG, Tongue Holding Forceps 195
 YOUNGER-GOOD, Curettes 306

Z

ZAHLE, Instruments for Laboratory 346
 ZAUFAL-JANSEN, Bone rongeurs 244
 ZIEGLER, Knives 79
 ZIELINSKY, Measuring Instruments 330

A1-Z1



A1-Z1 |

Alphanumeric Index
Alphanumerischen Index
Index alphanumérique
Índice alfanumérico
Índice alfanumerico



1	3	712-111	293	717-39	300	718-M8	227	AT-1	268
2	3	712-111L	293	717-64	300	718-M9	226	AT-2L	268
4	8	712-112	293	717-66	300	718-PR3	226	AT-2R	268
7	3	712-112L	293	717-100	300	718-RO-4	307	AT-6	268
8	8	712-113	293	717-101	300	718-TO3	306	AT-12	268
13	6	712-113L	293	717-102	300	718-YGO8	306	B-3	281
17	3	712-121	293	717-103	300	719-111	307	B-4	281
18	3	712-121L	293	717-104	300	719-125	307	B-28/29	281
21	8	712-122	293	717-111	300	719-126	307	B-31/32	281
22 1/2L	11	712-122L	293	717-112	300	720-85	232	B-32	281
22 1/2R	11	712-123	293	718-1/2	302	720-86	232	B-33	281
22	6	712-123L	293	718-2R	303	720-87	232	B-34	281
29	4	712-124	293	718-3/4	302	720-88	232	B-35	281
30	4	712-124L	293	718-4R	303	720-101	232	BB-46	75
33	6	712-131	295	718-5/6	302	720-102	232	BB-48	75
33A	6	712-132	295	718-7/8	302	720-103	232	BD-01	121
46L	12	712-133	295	718-9/10	302	720-104	232	BD-02	121
48	12	712-161H	294	718-11MD	303	720-111	239	BD-03	121
49	12	712-162H	294	718-11/12	302	720-112	239	BD-04	124
51	5	712-163H	294	718-13MD	303	725-1/2	47	BD-05	124
51A	5	712-164H	294	718-13/14	302	725-3/4	47	BD-06	124
51L	5	712-171	295	718-14	303	725-3/4S	47	BD-07	124
55	10	712-172	295	718-24G	229	725-5/6	47	BD-08	345
56	10	712-182	295	718-103	286	751-2/3	341	BD-09	134
67A	5	712-183	295	718-104	286	751-121	341	BD-09T	118
68	10	712-191	296	718-107	286	751-122	341	BD-10	125
68A	10	712-192	296	718-113	286	751-123	341	BD-11	121
73	6	712-201	296	718-123	301	751-124	341	BD-14	135
74	7	712-202	296	718-133	301	751-125	341	BD-16	125
74N	7	712-221	296	718-147	301	A-1	275	BD-18	134
75	7	712-222	296	718-148	301	AL-MA5	257	BD-19	128
79	8	712-223	296	718-149	301	AL-PT1	343	BD-20	134
79A	8	712-231	296	718-151	301	AL-PT2	343	BD-21	128
86A	7	712-232	296	718-154	301	AL-PT3	343	BD-23	134
87	9	712-233	296	718-156	301	AL-PT4	343	BD-25	134
89	9	712-241	229, 295	718-162	301	AL-PT5	343	BD-26	134
90	9	712-242	295	718-165	301	AL-SETC/1	344	BD-27	138
400	38	712-243	295	718-170	301	AL-SETC/2	344	BD-30	132
401	38	712-251	296	718-191	228	AM-1	24	BD-30T	118
707-1N	290	712-256	296	718-192	228	AM-5	31	BD-31	132
707-2N	290	712-259	296	718-204	306	AM-15	30	BD-31T	118
707-3GF	289	712-PFI	294	718-204S	306	AM-16	30	BD-32	124
707-3UM	290	713-101	299	718-204SD	306	AM-17	29	BD-33	124
707-3W	289	713-102	299	718-210	239	AM-18L	27	BD-35	124
707-6D1	288	714-101	294	718-212	239	AM-18R	27	BD-36	124
707-6D2	288	714-102	294	718-212S	239	AM-23	29	BD-38	128
707-6D3	288	714-CV11	299	718-214S	239	AM-24	27	BD-39	128
707-16D1	288	715-101	297	718-215	204	AM-32	26	BD-40	127
707-16D2	288	715-102	297	718-216	204	AM-32A	26	BD-41	127
707-16GF	289	715-103	297	718-223	228	AM-53L	25	BD-42	127
707-16UM	290	715-103S	297	718-232	303	AM-53R	25	BD-43	127
707-16W	289	715-311	291	718-234	303	AM-62	24	BD-44	127
707-17GF	289	715-312	291	718-251	303	AM-65	26	BD-45	127
707-17UM	290	715-404	297	718-252	303	AM-69	28	BD-46	127
707-17W	289	715-408	297	718-268	307	AM-88L	25	BD-47	127
707-23D1	288	716-101	299	718-271	304	AM-88R	25	BD-51	133
707-23D2	288	716-102	299	718-272	304	AM-101	28	BD-53	135
707-23GF	289	716-103	299	718-273	304	AM-103	30	BD-56	130
707-23UM	290	716-104	299	718-274	304	AM-150	24	BD-57	130
707-23W	289	716-201	298	718-275	304	AM-150A	24	BD-58	130
707-202	288	716-202	298	718-277	304	AM-150AS	33	BD-59	130
707-202A	288	716-203	298	718-282	305	AM-150S	33	BD-60	126
707-203	288	716-204	298	718-282A	305	AM-150X	32	BD-61	126
707-2311	290	716-211	298	718-284	305	AM-151	28	BD-62	126
707-2312	290	716-212	298	718-284S	305	AM-151AS	33	BD-63	126
707-GFW	289	716-232	298	718-288S	305	AM-151S	33	BD-65	126
707-UT1	288	716-234	298	718-332	305	AM-151X	32	BD-67	126
711-301	291	716-236	298	718-333	305	AM-203	29	BD-70	132
711-302	291	717-6	300	718-335	305	AM-210	27	BD-71	122, 132
711-303	291	717-14	300	718-CIO3	306	AM-222	31	BD-72	132
712-18	292	717-17	300	718-CK3	301	AM-250	31	BD-73	122, 132
712-27S	292	717-17W	300	718-CK6	306	AMG-150	34	BD-75	125
712-29	292	717-18	300	718-EN1	229	AMG-150S	34	BD-75T	118
712-101	292	717-18W	300	718-EN2	229	AMG-151	34	BD-76	125
712-102	292	717-19	300	718-EN3	229	AMG-151S	34	BD-80	122
712-103	292	717-19W	300	718-GF14	227	APICAL-1	52	BD-80T	118
712-104	292	717-31L	300	718-M23	267	APICAL-2	52	BD-81	122
712-105	292	717-32L	300	718-M23A	267	APICAL-3	52	BD-82	122
712-106	292	717-33L	300	718-M23B	267	APICAL-4	52	BD-83	122



BD-90	131	BD-282	128	BS-41	350	BT-157	183	CP	339
BD-91	127	BD-283	123	BS-42	350	BT-158	192	CPL	339
BD-92	131	BD-284	123	BS-43	350	BT-159	192	CPS	339
BD-93	131	BD-285T	118	BS-59	351	BT-183	225	CS-01	349
BD-94	131	BD-287	135	BS-60	206, 207, 351	BT-184	225	CS-02	349
BD-95	127	BD-288	135	BS-61	351	BT-185	225	CS-03	349
BD-96	124	BD-289	135	BS-100	354	BT-186	177	CS-04	349
BD-97	125	BD-290	135	BT-1	179	BT-187	177	CS-05	349
BD-98	125	BD-291	135	BT-2	179	BT-188	177	CS-12	349
BD-99	125	BD-292	135	BT-05	225	BT-189	177	CS-15	349
BD-104	128	BD-348	114	BT-06	225	BT-210	177	CS-19	349
BD-109	128	BD-349	114	BT-07	225	BT-211	177	CT-555	351
BD-110	128	BD-351	135	BT-07M	225	BT-212	177	CT-555N	355
BD-111	128	BD-352	135	BT-15	177	BT-213	177	CT-556N	355
BD-130	130	BD-353	135	BT-16	177	BT-214	177	CT-557N	355
BD-131	130	BD-354	135	BT-18	179	BT-260	184	CT-558N	355
BD-133	128	BD-355	135	BT-19	179	BT-264	181	CT-559N	355
BD-134	128	BD-356	135	BT-20	190	BT-265	181	CT-560	351
BD-135	133	BD-360	113	BT-25	190	BT-283	190	CT-560N	355
BD-137	128	BD-361	113	BT-26	180	BT-284	190	CT-561N	355
BD-141	131	BD-362	113	BT-27	180	BT-285	190	CT-562N	355
BD-142	126	BD-363	113	BT-29	180	BT-286	190	CT-563N	355
BD-143	126	BD-364	113	BT-33	184	BT-287	190	CT-564N	355
BD-144	128	BD-365	113	BT-34	184	BT-288	190	CT-565	351
BD-145	125	BD-366	113	BT-35	184	BT-289	190	CT-565N	355
BD-148	125	BD-367	113	BT-36	184	BV-23	220	CT-566N	355
BD-158	138	BD-370	132	BT-38	178	C-1	233	CT-567N	355
BD-159	138	BD-371	132	BT-39	178	C-2	233	CT-568N	355
BD-160	122	BD-372	133	BT-40	178	C-3	233	CT-569N	355
BD-160T	118	BD-373	133	BT-41	178	C-4	233	CT-650	354
BD-161	122	BD-377	133	BT-42	178	C-11	337	CT-651	351
BD-165	122	BD-378	133	BT-43	184	C-12	337	CT-652	351
BD-175	138	BD-379	133	BT-44	178	C-13	337	CT-653	351
BD-177	122	BD-380	131	BT-45	178	C-30	337	CU-1/2	261
BD-178	122	BD-381	131	BT-46	178	C-34	337	CU-3/4	261
BD-194	124	BD-382	131	BT-48	180	C-35	337	CU-5/6	261
BD-195	124	BEIN-1T	51	BT-49	180	C-36	337	CU-7/8	261
BD-196	124	BEIN-1Z	57	BT-50	178	C-41	337	CU-9/10	261
BD-207	114	BEIN-2	51	BT-51	178	C-42	337	CU-11/12	261
BD-208	114	BEIN-2Z	57	BT-52	178	C-43	337	CU-13/14	261
BD-209	114	BEIN-3	51	BT-54	178	C-71	336	CU-MC1	231
BD-210	137	BEIN-4	51	BT-55	178	C-72	336	CV-11	276
BD-211	137	BEIN-4Z	57	BT-56	178	C-73	336	DA-01	40
BD-212	137	BF-10	167	BT-60	184	C-74	336	DA-01M	40
BD-213	137	BF-12	167	BT-62	184	CD-1	276	DA-02	40
BD-216	137	BF-20	167	BT-64	184	CD-2	276	DA-03	40
BD-217	137	BF-22	167, 329	BT-66	184	CD-3	276	DA-04	120
BD-221	137	BF-23	167	BT-67	187	CD-4	276	DA-05	120
BD-222	137	BF-24	167	BT-68	187	CG	339	DA-06	138
BD-223	137	BF-25	167	BT-69	194	CGL	339	DA-07	138
BD-224	137	BF-38	165	BT-70	179	CGS	339	DA-08	138
BD-230	136	BF-40	165	BT-72	179	CH-1	70	DA-09	121
BD-231	136	BF-41	165	BT-74	179	CH-2	70	DA-10	40
BD-232	136	BF-42	165	BT-77	179	CH-3	70	DB-01	123
BD-240	126	BF-43	165	BT-80	182	CH-4	70	DB-02	123
BD-241	126	BF-44	165	BT-81	182	CH-11	70	DB-07	356
BD-242	126	BF-45	165	BT-82	182	CH-12	70	DB-08	356
BD-243	126	BF-46	165	BT-90	182	CH-13	70	DB-1L	356
BD-244	126	BF-48	165	BT-91	182	CH-14	70	DB-3	356
BD-245	126	BF-50	166	BT-92	183	CL-1B	344	DB-4	356
BD-246	126	BF-52	166	BT-93	183	CL-1R	344	DB-6A	356
BD-247	126	BF-75	166	BT-94	183	CL-2B	344	DB-10	356
BD-248	126	BF-94	167	BT-95	183	CL-2R	344	DB-10M	356
BD-249	126	BF-95	167	BT-96	183	CL-3B	344	DB-11	356
BD-250	136	BK-30	346	BT-100	183	CL-3R	344	DB-12	356
BD-251	136	BM-01	157	BT-109	180	CM	340	DB-15	356
BD-253	114	BM-02	157	BT-117	179	CO-1	54	DB-50M	356
BD-267	137	BM-03	157	BT-118	179	CO-2	54	DB-96	356
BD-270	125	BM-04	157	BT-131	194	CO-3	54	DB-177	246
BD-270T	118	BM-61	150	BT-132	194	CO-11	54	DB-178	246
BD-271	134	BM-62	150	BT-134	181	CO-12	54	DB-179	246
BD-272	134	BM-63	150	BT-135	181	CO-13	54	DB-180	246
BD-273	134	BR-20	349	BT-139	180	COL-1/2	261	DB-181	246
BD-274	134	BR-25	349	BT-140	180	COL-2RL	261	DB-182	246
BD-275	134	BR-28	349	BT-152	183	COL-3/4	261	DB-183	246
BD-276	134	BS-1	349	BT-153	183	COL-4RL	261	DB-299	356
BD-279	123	BS-27	349	BT-154	183	COL-13/14	261	DB-300	219
BD-280	123	BS-32	349	BT-155	183	COLLEGE	120, 329	DB-OL	356
BD-281	128	BS-40	350	BT-156	183	COLLEGE-S	120	DEAN	94



DEAN-TC	102	DL-28	53	DL-118	43	DP-725	330	FD-563T	147
DF-00	308	DL-30	57	DL-123	61	DP-730	330	FD-574T	147
DF-00L	308	DL-31	57	DL-124	61	DR-40	39, 169	FD-575T	147
DF-00M	308	DL-32	53	DL-C	338	DR-50	39	FD-587T	147
DF-00N	308	DL-33	53	DL-V	338	DR-60	39	FD-588T	147
DF-00P	308	DL-34	50	DO-1	238	DR-70	39	FD-599	146
DF-00R	308	DL-35	50	DO-2	238	DR-78	138, 329	FD-600	146
DF-00V	308	DL-36	50	DO-3	238	DR-80	138	FD-601	146
DF-01/5	312	DL-37	50	DO-4	238	E-0	284	FD-602	146
DF-01/6	312	DL-38	50	DO-4C	238	E-1	284	FE-1	273
DF-01/7	312	DL-42	43	DO-5	238	E-2	284	FE-2	273
DF-02	308	DL-43	43	DO-08	186	E-3	284	FE-3	273
DF-02M	308	DL-44	43	DO-09	186	E-4	284	FE-4	273
DF-02P	308	DL-45	43	DO-40	186	EC-1	284	FE-4/5	273
DF-02R	308	DL-46	43	DO-41	192	EC-2	284	FE-5	273
DF-03/1	312	DL-47	43	DO-59	223	EN-M1	228	FE-6	273
DF-03/2	312	DL-48	59	DO-63	223	EN-M2	228	FG-1	86
DF-03/3	312	DL-49	59	DO-65	223	EN-M3	228	FG-1SC	104
DF-03/7	312	DL-50	234	DO-67	223	EN-M4	228	FG-1SCZ	104
DF-03/8	312	DL-51	234	DO-140	202	EN-M5	228	FG-1TC	101
DF-03/9	312	DL-52	234	DO-141	202	EN-M6	228	FG-2	86
DF-03/10	312	DL-54	59	DO-142	192	EN-M7	228	FG-2SC	104
DF-03/11	312	DL-55	59	DO-143	202	ES-13	204	FG-2SCZ	104
DF-03/12	312	DL-58	48	DO-175	184	ES-27	229	FG-2TC	101
DF-03/13	312	DL-59	62	DO-180	202	ES-44	130	FG-3	87
DF-04	312	DL-60	338	DO-181	202	ES-65	130	FG-4	86
DF-05/5	312	DL-61	62	DO-182	202	EX-11	252	FG-5	86
DF-05/6	312	DL-62	62	DO-183	202	EX-12	252	FG-11L	86
DF-05/7	312	DL-63	62	DO-184	202	F-2/3	276	FG-12L	86
DF-06	312	DL-64	64	DO-185	202	FD-06	84	FG-13	88
DF-07	312	DL-65	64	DO-186	202	FD-08	84	FG-14	89
DF-08	312	DL-66	64	DO-196	200	FD-10	83	FG-15	88
DF-09	312	DL-67	64	DO-204	184	FD-12	83	FG-19C	93
DF-10	309	DL-68	62	DO-204L	184	FD-13	83	FG-19R	93
DF-12	310	DL-69	62	DO-212	184	FD-14	141	FG-20	94
DF-15	309	DL-73	61	DP-24	335	FD-15	83	FG-21	90
DF-16	309	DL-74	61	DP-24C	335	FD-16	141	FG-22	90
DF-18	309	DL-75	61	DP-24R	335	FD-17	141	FG-23	88
DF-20	327	DL-76	49	DP-28	335	FD-18	144	FG-24	88
DF-21	327	DL-77	49	DP-29	335	FD-19	141	FG-28	89
DF-30	311	DL-78	49	DP-38	335	FD-20	144	FG-36	90
DF-32	311	DL-79	49	DP-38A	335	FD-21	146	FG-37	90
DF-40	310	DL-81	44	DP-38R	335	FD-22	144	FG-38	95
DF-40/1	310	DL-82	44	DP-50	328	FD-22A	144	FG-39	95
DF-40/2	310	DL-83	44	DP-52	329	FD-23	146	FG-50	93
DF-40/3	310	DL-84	44	DP-54	328	FD-24	142	FG-51	93
DF-41	310	DL-85	44	DP-90	109, 326	FD-25	145	FG-52	93
DF-41/4	310	DL-86	44	DP-91	109, 326	FD-26	141	FG-53	93
DF-41/5	310	DL-87	44	DP-92	109, 326	FD-28	144	FG-54	93
DF-41/6	310	DL-88	62	DP-100	328	FD-29	145	FG-55	93
DF-43	310	DL-89	62	DP-101	109, 326	FD-30	145	FG-58	87
DF-50	327	DL-90	65	DP-102	109, 326	FD-31	143	FG-59	86
DF-126	311	DL-91	45	DP-103	109, 326	FD-32	145	FG-60	98
DF-127	311	DL-92	45	DP-104	109	FD-33	148	FG-61	98
DF-128	311	DL-93	45	DP-105	109	FD-34	143	FG-66	93
DF-129	311	DL-94	45	DP-114	324	FD-35	148	FG-67	93
DF-130	311	DL-95	45	DP-116	324	FD-36	143	FG-92	106
DF-131	311	DL-96	45	DP-118	323	FD-37	143	FG-98	106
DF-151	311	DL-97	45	DP-119	323	FD-38	148	FG-101	90
DF-160	311	DL-98	60	DP-120	107, 326	FD-41	83	FG-102	90
DK-26	38	DL-99	60	DP-121	323	FD-42	83	FG-103	88
DK-27	38	DL-100	63	DP-124	328	FD-64	83	FG-104	88
DL-0	338	DL-101	63	DP-125	328	FD-65	83	FG-105	88
DL-1	53	DL-102	46	DP-126	329	FD-137	83	FG-112	86
DL-2	53	DL-103	46	DP-127	329	FD-138	83	FG-113	86
DL-05	59	DL-104	46	DP-128	329	FD-145	84	FG-121	91
DL-06	59	DL-105	46	DP-129	329	FD-170	145	FG-123	87
DL-11	56	DL-106	43	DP-132	329	FD-171	145	FG-124	87
DL-13	56	DL-107	43	DP-133	329	FD-172	143	FG-147	89
DL-14	56	DL-108	65	DP-134	324	FD-173	143	FG-148	89
DL-17	56	DL-109	65	DP-135	324	FD-182	84	FG-153	106
DL-18	56	DL-110	65	DP-136	338	FD-183	84	FG-154	106
DL-19	56	DL-111	65	DP-137	338	FD-216	142	FG-156	87
DL-20	48	DL-112	46	DP-140	331	FD-217	142	FG-157	87
DL-21	48	DL-113	46	DP-150	327	FD-224	84	FG-158	87
DL-22	48	DL-114	46	DP-720	330	FD-225	84	FG-159	87
DL-24	60	DL-115	46	DP-721	330	FD-236	142	FG-160	107, 325
DL-25	60	DL-116	43	DP-723	330	FD-237	142	FG-161	325
DL-27	53	DL-117	43	DP-724	330	FD-562T	147	FG-167	101



FG-168	101	FL-13	201	FL-231	202	FM-100L	103	G-18	258
FG-190	91	FL-14	201	FL-232	202	FM-102	103	G-20	258
FG-191	91	FL-15	201	FL-263	199	FM-104	103	G-22	258
FG-207	85	FL-16	199	FL-264	199	FM-109	89	G-24	258
FG-208	85	FL-17	199	FL-265	199	FM-118	101	G-26	258
FG-209	85	FL-18	199	FL-266	199	FM-119	101	G-28	258
FG-210	85	FL-20	216	FL-267	199	FM-126	89	G-30	258
FG-211	85	FL-21	216	FL-268	199	FM-127	89	GA-17	215
FG-212	85	FL-25	212	FL-269	199	FM-146	107	GA-18	215
FG-216	85	FL-26	212	FL-292	209	FM-180	95	GA-19	215
FK-1	92	FL-27	212	FL-293	209	FM-181	95	GA-20	215
FK-1SC	102	FL-28	212	FL-294	209	FM-201	100	GA-33	213
FK-1TC	102	FL-31	216	FL-295	209	FM-202	100	GA-34	213
FK-2	92	FL-32	199	FL-296	209	FM-203	100	GA-35	213
FK-2SC	102	FL-33	216	FL-297	209	FM-204	100	GA-36	213
FK-2TC	102	FL-35	216	FL-298	209	FM-298	97	GA-37	213
FK-60	236	FL-37	212	FL-299	209	FM-299	97	GA-60	213
FK-61	236	FL-38	212	FL-389	207	FM-300	97	GA-63	213
FK-62	236	FL-39	212	FL-390	207	FM-301	97	GA-64	213
FK-63	236	FL-53	199	FL-391	207	FM-317	101	GA-65	213
FK-64	236	FL-54	199	FL-392	207	FM-318	97	GA-66	213
FK-65	236	FL-58	199	FL-393	207	FM-319	97	GA-70	216
FK-66	236	FL-59	202	FL-394	207	FM-339	106	GA-71	217
FK-67	236	FL-60	202	FL-395	207	FM-350	101	GA-73	217
FK-70	235	FL-61	202	FL-396	207	FO-08	242	GA-78	217
FK-71	235	FL-65	211	FL-397	207	FO-09	242	GA-79	217
FK-72	235	FL-66	211	FL-398	207	FO-15	242	GA-80	217
FK-73	235	FL-67	211	FL-399	207	FO-16	244	GA-81	217
FK-75	235	FL-68	211	FL-411	202	FO-17	242	GA-85	217
FK-76	235	FL-69	211	FL-412	202	FO-18	243	GA-86	217
FK-77	235	FL-70	211	FL-413	202	FO-19	242	GA-90	217
FK-78	235	FL-71	211	FL-414	202	FO-20	244	GA-91	217
FK-83	234	FL-72	211	FL-415	202	FO-21	242	GB-2	78
FK-84	234	FL-73	211	FL-416	202	FO-22	241	GB-4	76
FK-87	92	FL-74	211	FLAGG	120	FO-23	241	GF-01	317
FK-88	92	FL-75	211	FLOHR-1	52	FO-24	241	GF-02	317
FK-100	205	FL-76	211	FLOHR-2	52	FO-25	243	GF-03	317
FK-101	205	FL-77	211	FLOHR-3	52	FO-26	245	GF-04	317
FK-102	205	FL-78	211	FM-1	98	FO-33	246	GF-05	317
FK-103	205	FL-79	211	FM-1F	98	FO-34	244	GF-06	315
FK-104	205	FL-80	211	FM-1SC	104	FO-43	243	GF-07	315
FK-105	205	FL-104	203	FM-2	98	FO-60	245	GF-10	315
FK-106	205	FL-114	200	FM-2F	98	FO-61	245	GF-11	317
FK-107	205	FL-115	200	FM-2SC	104	FO-77	245	GF-12	315
FK-108	205	FL-116	200	FM-3	99	FO-85	241	GF-13	316
FK-109	205	FL-120	208	FM-3F	99	FO-87	241	GF-14	316
FK-110	236	FL-121	208	FM-3SC	104	FO-88	241	GF-15	316
FK-111	236	FL-122	208	FM-4	99	FO-89	241	GF-16	316
FK-112	236	FL-123	208	FM-4F	99	FO-130	220	GF-20	316
FK-113	236	FL-124	208	FM-4SC	104	FO-131	220	GF-30	316
FK-114	236	FL-125	208	FM-5	96	FO-131S	220	GF-31	316
FK-115	236	FL-128	203	FM-5SC	104	FO-138	244	GF-32	316
FK-116	236	FL-132	200	FM-6	96	FO-139	244	GF-33	316
FK-120	236	FL-135	200	FM-6SC	104	FO-156	244	GF-34	316
FK-121	236	FL-136	200	FM-7	96	FO-157	244	GF-35	316
FK-122	236	FL-141	210	FM-8	96	FO-159	220	GF-40	320
FK-123	236	FL-142	210	FM-9	96	FO-162	246	GF-41	319
FK-124	236	FL-143	210	FM-10	96	FO-163	246	GF-42	319
FK-125	236	FL-144	210	FM-12	89	FO-165	246	GF-54	315
FK-126	236	FL-150	213	FM-27	96	FO-216	242	GF-60	319
FK-136	234	FL-151	213	FM-28	96	FO-220	241	GF-61	319
FK-137	234	FL-152	213	FM-41	96	FO-221	242	GF-69	319
FK-138	234	FL-153	213	FM-42	96	FO-229	243	GF-70	319
FK-139	234	FL-155	213	FM-47	98	FO-230	243	GF-133	214, 317
FK-188	234	FL-156	213	FM-48	98	FO-231	245	GF-134	214
FK-189	234	FL-157	213	FM-49	96	FO-232	245	GF-180	318
FK-197	234	FL-158	213	FM-51	107	FO-233	245	GF-182	320
FK-198	234	FL-159	213	FM-59	107	FO-234	245	GF-183	320
FL-01	203	FL-177	201	FM-63	96	FR-16	204	GF-184	318
FL-03	201	FL-179	201	FM-66	99	FR-17	204	GF-185	320
FL-04	201	FL-181	201	FM-67	99	FREER	204, 226	GF-188	320
FL-05	201	FL-183	201	FM-68	99	G-3	257	GF-200	320, 357
FL-09	203	FL-184	201	FM-69	99	G-4	257	GF-240	318
FL-09R	203	FL-185	201	FM-79	95	G-5	257	GF-241	318
FL-10M	203	FL-186	201	FM-96	100	G-8	258	GF-242	318
FL-11	203	FL-187	201	FM-97	100	G-10	258	GF-242B	318
FL-11R	203	FL-188	201	FM-98	100	G-12	258	GF-243	318
FL-12	203	FL-189	201	FM-99	100	G-14	258	GF-244	318
FL-12R	203	FL-230	202	FM-100	103	G-16	258	GF-271	317



GF-901	317	KO-11	227	LB-369	75	MF-144T	119	NK-38	80
GFC	91	KO-20	229	LC-1	345	MF-145T	119	NK-39	79
GFC-S	91	KO-22	224	LC-2	345	MF-146T	119	NK-40	80
GFC-SC	105	KO-23	224	LC-3	345	MF-147T	119	NK-105	204
GFC-TC	106	KO-58	226	LG-1	94	MF-177	114	NK-249	204
GFR	91	KO-66	227	LG-1SC	105	MF-249	114	NK-251	204
GFR-S	91	L-0	72	LG-2SC	105	MF-370	116	O-1	277
GFR-SC	105	L-1	72	LG-6	94	MF-371	116	O-2	277
GFR-TC	106	L-2	72	LK-1	90	MF-372	116	O-3	277
GFS	94	L-3	72	LK-2	92	MF-373	116	O-4	277
GFS-SC	105	L-4	72	LK-3	90	MF-374	116	OA-1	279
GM-01	215	L-5	72	LK-4	92	MF-375	116	OA-2	279
GM-02	215	L-6	72	LK-10	102	MF-376	116	OA-3	279
GO-1	273	L-7	72	LK-12	102	MF-377	116	OBN-1	287
GO-2	273	L-8	72	LS-08	218	MF-378	117	OBN-2	287
GO-3	273	L-9	72	LS-09	218	MF-379	117	OBN-4	287
GO-4	273	L-11	72	LX-50	240	MF-380	117	OC-1	278
GS-02	358	L-21	72	LX-52	240	MF-381	117	OC-2	278
GS-03	358	L-22	72	LX-60	240	MF-382	117	OF-1	285
GS-04	358	L-23	72	LX-84	323	MF-383	117	OF-2	285
GS-06	358	L-24	72	LX-85	323	MF-384	117	OF-3	285
GS-10	358	L-25	72	LX-87	323	MF-385	117	OK-1	277
GS-13	358	L-26	72	LX-101	324	MI-10	55	OK-2	277
GS-16	78	L-27	72	LX-102	325	MI-11	55	OK-3	277
GS-18	78	L-28	72	LX-103	325	MI-12	55	OL-1	278
GS-26	109	L-29	72	LX-113	220	MI-13	55	OL-2	278
GS-40	357	L-51	71	MA-1	257	MIR-08	229	OL-3	278
GS-42	357	L-52	71	MA-1A	257	MIR-09	71	OM-2	280
GS-44	357	L-53	71	MA-2	257	MIR-10	236	OM-04	195
GS-48	357	L-54	71	MA-2A	257	MIR-20	54	OM-06	186
GS-52	357	L-55	71	MA-3	257	MIR-21	54	OM-07	195
H4422	345	L-56	71	MA-6	258	MIR-22	54	OM-08	186
H-1	275	L-57	71	MA-7	257	MIR-23	54	OM-10	195
H-2	275	L-58	71	MA-8	71	MIR-24	54	OM-16	195
H-3	275	L-59	71	MA-9	71	MIR-25	54	OM-18	195
HA	346	L-60	71	MA-9R	71	MIR-26	54	OM-19	195
HB	229, 345	L-71	71	MA-B1	77	MIR-30	206	OM-30	195
HC	345	L-72	71	MA-B2	77	MIR-31	206	OM-40	188
HE-1	47	L-73	71	MA-B3	77	MIR-32	206	OM-40R	188
HE-2	47	LA-1	66	MA-B3M	77	MIR-33	206	OM-41	188
HE-3	47	LA-2	66	MA-B4	78	MO-2	237	OM-41R	188
HF-3/7	267	LA-3	66	MA-B7	77	MO-4	237	OM-42	188
HF-5/11	267	LA-4	66	MA-B7K	77	MO-4L	237	OM-44	195
HF-9/10	267	LA-5	66	MA-B8	77	MO-4LT	237	OM-45	195
HL	346	LA-6	66	MA-B9	77	MO-4RT	237	OM-50	191
HP-6	58	LA-7	67	MA-B16	76	MO-8	229	OM-52	191
HR	345	LA-8	67	MC-11	71	MO-9A	226	OM-55	191
HV	345	LA-9	67	MC-12	71	MO-10	231, 237	OM-55B	191
I-13	19	LA-10	67	MC-13	71	MO-12	231	OM-60	188
I-22 1/2L	22	LA-11	68	MC-70	71	MO-15	225	OM-61	191
I-22 1/2R	22	LA-12	68	MD-1	35	MO-20	227	OM-62	188
I-22	19	LA-13	68	MD-2	35	MO-24	227	OM-66	191
I-36	18	LA-16	68	MD-3	35	MOLT-9	226	OM-66B	191
I-36N	18	LA-17	68	MD-4	35	MPI-1	214	OM-67	191
I-46L	21	LA-20	69	MEAD	223	MRT/C7	336	OM-70	196
I-46LX	21	LA-21	69	MERIAM	120	MRT-6	336	OM-71	196
I-46N	20	LA-22	69	MF-101	129	MRT-7	336	OM-72	196
I-59	19	LA-23	69	MF-101T	118	MRT-C1	337	OM-74	189
I-73	19	LB-10	77	MF-102	129	MRT-C3	337	OM-75	189
I-74	18	LB-11	77	MF-102T	118	MRT-C4	337	OM-76	189
I-74N	18	LB-12	77	MF-103	129	NK-1	76	OM-77	189
I-79	20	LB-12D	77	MF-104	129	NK-2	76	OM-80	185
I-79N	20	LB-13	77	MF-105	129	NK-3	76	OM-81	185
I-86C	19	LB-15	77	MF-106	136	NK-06	79	OM-82	185
I-87	20	LB-15A	77	MF-107	136	NK-07	79	OM-85	185
I-133L	23	LB-15C	77	MF-110	115	NK-08	79	OM-87	185
I-133R	23	LB-18	78	MF-111	115	NK-09	79	OM-88	185
I-333S	23	LB-20	78	MF-112	115	NK-10	79	OM-90	189
IM-15	214	LB-21	78	MF-113	115	NK-11	79	OM-97	189
KE-20	196	LB-23	78	MF-114	115	NK-12	75	OM-100	185
KE-40	196	LB-40	75	MF-115	115	NK-14	79	OM-110	193
KKD-1	287	LB-361	75	MF-124	119	NK-16	79	OM-112	193
KKD-2	287	LB-362	75	MF-125	119	NK-17	79	OM-113	193
KKD-4	287	LB-363	75	MF-126	119	NK-18	79	OM-114	193
KN-55	200	LB-364	75	MF-127	119	NK-20	79	OM-136	193
KN-75	200	LB-365	75	MF-128	119	NK-30	80	OM-137	193
KO-1	224	LB-366	75	MF-129	119	NK-32	80	OM-138	193
KO-2	224	LB-367	75	MF-142T	119	NK-34	80	OM-139	193
KO-3	224	LB-368	75	MF-143T	119	NK-36	80	ON-1	280



OP-1	279	P-100	174	PH-72	155	PO-105	157	SL-21	233
OP-2	279	P-101	169	PH-73	153	PR-3	226	SM-1	253
OP-3	279	P-102	169	PH-74	159	PR-3A	226	SM-2	253
OP-4	279	P-115	174	PH-75	155	PS-1	346	SM-3	253
OP-5	279	P-120	168	PH-76	155	PS-2	346	SM-4	253
OP-7	216	P-121	168	PH-77	155	PT-1	342	SM-5	253
OP-8	216	P-129	174	PH-79	152	PT-2	342	SM-6	253
OR-11	218	P-135	169	PH-80	151	PT-3	342	SM-11	251
OR-12	218	P-136	171	PH-81	151	PT-4	342	SM-12	251
OR-13	218	P-137	171	PH-82	151	PT-5	342	SM-13	251
OR-14	218	P-215	171	PH-83	151	PZ-1	254	SM-15	251
OR-18	218	P-216	171	PH-84	151	PZ-2	254	SM-19	251
OR-19	218	P-217	171	PH-85	152	PZ-3	254	SM-20	252
OR-40	218	P-230	173	PH-90	156	PZ-4	254	SM-21	251
OR-45	218	P-231	173	PH-99	156	R-1	275	SM-22	252
OS-1	280	P-232	173	PH-100	156	R-2	275	SO-1	249
OS-2	280	P-233	173	PH-101	154	R-3	275	SO-2	249
OSB-1	286	P-238	173	PH-102	154	RH-4	257	SO-3	249
OSB-2	286	P-239	173	PH-103	154	RH-4A	257	SO-4	249
OSB-4	285	P-240	173	PH-106	152	RH-5	257	SO-5	249
OSB-4A	285	P-241	173	PH-110	154	RH-5A	257	SO-6	249
OT-1	271	P-250	171	PH-111	154	RH-14	257	SO-7	250
OT-2	271	P-251	171	PH-120	154	RO-1	39	SO-8	250
OT-3	271	P-252	171	PH-121	154	S18-8	340	SO-9	250
OT-4	271	P-253	171	PH-122	154	S-0	274	SO-10	250
OT-5	271	P-256	171	PH-127	154	S-00	274	SO-11	250
OT-6	271	P-257	171	PH-128	154	S-1	274	SO-12	250
OT-7	271	P-260	171	PH-129	154	S-2	274	SO-20	252
OT-8	271	P-261	171	PH-132	155	S-3	274	SP-1	255
OT-9	271	P-264	168	PH-133	155	S-3AN	13	SP-2	255
OT-10	271	P-265	168	PH-134	155	S-4	274	SP-3	255
OT-11	272	P-266	168	PH-140	148	S-7	13	SP-4	255
OT-12	272	P-267	168	PH-141	148	S-31	14	SP-5	255
OT-13	272	P-324	174	PH-142	148	S-34	13	SP-6	255
OT-14	272	P-332	168	PL-1	254	S-35	13	SP-7	255
OT-15	272	P-340	219	PL-2	254	S-49	17	SR	274
OT-16	272	P-341	219	PL-3	254	S-51B	16	SS-15	270
OX-1	280	P-342	219	PL-4	254	S-51LX	17	SS-16	270
OX-2	280	PEB-1	37	PM-1	282	S-66L	14	SS-20	216
OX-3	280	PEB-2	37	PM-2	282	S-66R	14	SS-21	216
OZ-1	278	PEB-3	37	PM-3	282	S-67L	15	SS-22	216
OZ-2	278	PEB-4	37	PM-4	282	S-67N	15	SS-41	270
OZ-3	278	PEB-5	37	PM-5	282	S-67R	15	SS-42	270
P-0	258	PEB-6	37	PM-6	282	S-80	16	SS-50	269
P-00	258	PEB-7	37	PO-37	159	S-97	16	SS-51	269
P-000	258	PEB-17S	36	PO-38	159	S-97B	16	SS-52	269
P-01	258	PEB-23S	36	PO-40	160	S-351S	17	SS-54	269
P-02	258	PEB-150S	36	PO-45	161	SA-1	340	SS-55	269
P-03	258	PEB-151S	36	PO-46	160	SA-2	340	SS-56	269
P-3	257	PF-1	328	PO-47	160	SA-3	340	SS-58	269
P-04	258	PF-2	328	PO-48	160	SC-1	108	SS-60M	215
P-4	257	PF-3	328	PO-50	158	SC-2	108	SS-61M	215
P-05	258	PF-6	214, 256	PO-51	158	SC-5	108	SS-62M	215
P-5	257	PF-9	268	PO-52	158	SC-9	108	SS-64M	215
P-06	258	PF-40	256	PO-55	158	SC-13	108	SS-65	214, 270
P-15	169	PF-41	256	PO-56	158	SC-14	108	STF-1	260
P-49	172	PH-37	149	PO-59	150	SC-15	108	STF-1R	260
P-50	174	PH-38	149	PO-60	161	SC-16	108	TASO-1	230
P-52	174	PH-39	149	PO-61	161	SD-1	260	TASO-2	230
P-61	173	PH-40	159	PO-65	160	SD-2	260	TASO-3	230
P-62	173	PH-41	159	PO-68	161	SD-3	260	TASO-4	230
P-63	173	PH-42	159	PO-69	161	SD-3R	260	TASO-5	230
P-64	173	PH-48	149	PO-71	161	SD-7	259	TASO-6	230
P-79	172	PH-53	153	PO-76	161	SD-7R	259	TASO-7	230
P-81	172	PH-54	156	PO-77	161	SD-8	259	TASO-8	230
P-82	172	PH-58	155, 325	PO-78	160	SD-8M	259	TASO-9	130
P-84	172	PH-59	155	PO-79	160	SD-8NA	259	TG-10	199
P-85	172	PH-60	336	PO-80	160	SD-20	259	TG-11	199
P-86	172	PH-61	149	PO-81	160	SD-M	72	TG-12	199
P-87	172	PH-62	149	PO-82	158	SE-2	58	TG-15	200
P-89	172	PH-63	149	PO-84	158	SE-4L	58	TG-17A	352
P-91	170	PH-64	149	PO-85	158	SE-4R	58	TG-17B	352
P-92	170	PH-65	153	PO-86	158	SIL-01	351	TG-17C	352
P-93	170	PH-66	153	PO-87	158	SIL-02	351	TG-17G	352
P-94	170	PH-67	153	PO-88	158	SIL-03	351	TG-17R	352
P-95	170	PH-68	153	PO-94	158	SIL-04	351	TG-17V	352
P-96	170, 329	PH-69	153	PO-99	157	SIL-05	351	TG-17Y	352
P-97	170, 329	PH-70	159	PO-99L	157	SL-1	231	TG-20	199
P-98	170	PH-71	156	PO-104	157	SL-2	231	TG-21	199



TG-22	199	USS-15/33	265		
TG-23	199	USS-204S	265		
TG-30	200	USS-H6/7	265		
TG-31	200	USS-J14/15	265		
TG-32	200	USS-KRA1	264		
T-I	354	USS-KRA3	264		
T-IF	354	USS-MC11/12	264		
TP-8A	353	USS-MC13/14	264		
TP-8B	353	USS-MC13/14S	264		
TP-8C	353	USS-MC17/18S	264		
TP-8G	353	USS-NV0	265		
TP-8R	353	USS-NV11/12	265		
TP-8V	353	USS-NV13/14	265		
TP-8Y	353	USS-T2/3	265		
TS-1	283	USS-YG7/8	206		
TS-2	283	UST-1/2MS	206		
TS-3	283	UST-1/2ML	206		
TS-4	283	UST-KPA	206		
TS-40	317	UST-MP	206		
TS-50	317	UST-MPA	206		
TS-101	350	VS-20	350		
TS-102	350	VS-26	350		
TS-103	350	VS-30	350		
TS-104	350	WEST	223		
TT-01	118	WG-10	223		
T-USG-1/2	266	WG-12	223		
T-USG-5/6	266	WG-14	223		
T-USG-7/8	266	Z-1	346		
T-USG-11/12	266	Z-2	346		
T-USG-13/14	266	Z-3	346		
T-USS-YG7/8	266				
T-USS-B5/6	266				
USB-P2	216				
USB-P3	216				
USB-P4	216				
USB-P1	216				
USB-P3Z	216				
USB-P1Z	216				
USB-P2Z	216				
USB-P4Z	216				
USC-2	276				
USC-2RL	264				
USC-4RL	264				
USC-13/14	264				
USG-1/2	263				
USG-1/2ET	262				
USG-1/2L	264				
USG-1/2S	263				
USG-3/4	263				
USG-3/4ET	262				
USG-3/4L	264				
USG-3/4S	263				
USG-5/6	263				
USG-5/6ET	262				
USG-5/6L	264				
USG-5/6S	263				
USG-7/8	263				
USG-7/8ET	262				
USG-7/8L	264				
USG-7/8S	263				
USG-9/10	263				
USG-9/10ET	262				
USG-9/10L	264				
USG-9/10S	263				
USG-11/12	263				
USG-11/12ET	262				
USG-11/12L	264				
USG-11/12S	263				
USG-13/14	263				
USG-13/14ET	262				
USG-13/14L	264				
USG-13/14S	263				
USG-15/16	264				
USG-15/16ET	262				
USG-17/18S	264				
USG-KN1/26	264				
USS-5/6LAN	264				
USS-5/33	265				
USS-15/30	265				

